

## Aluminum electrolytic capacitors

### Single-ended capacitors

**Series/Type:** B43086  
**Date:** December 2010

The following products presented in this data sheet are being withdrawn.

Ordering Code	Substitute Product	Date of Withdrawal	Deadline Last Orders	Last Shipments
B43086*	B43888	2013-02-22	2013-09-30	2014-03-31

For further information please contact your nearest EPCOS sales office, which will also support you in selecting a suitable substitute. The addresses of our worldwide sales network are presented at [www.epcos.com/sales](http://www.epcos.com/sales).

© EPCOS AG 2015. Reproduction, publication and dissemination of this publication, enclosures hereto and the information contained therein without EPCOS' prior express consent is prohibited.

EPCOS AG is a TDK Group Company.

## Long-life grade capacitors for professional applications

### Applications

- Electronic ballast applications
- Energy saving lamps
- Power supplies

### Features

- RoHS-compatible
- High ripple current
- High reliability
- Useful life of 10000 h at 105 °C

### Construction

- Radial leads
- Aluminum case, fully insulated
- Charge-discharge proof
- Minus pole marking on the insulating sleeve
- Case with safety vent

### Delivery mode

- Bulk
- Taped, Ammo pack
- Cut (see chapter "Single-ended – Taping, packing and lead configurations, Cut leads (Chapter A)")
- Kinked (see chapter "Single-ended – Taping, packing and lead configurations, Kinked leads (Chapter A)")

Refer to chapter "Single-ended capacitors – Taping, packing and lead configurations" for further details.

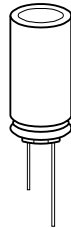

**Specifications and characteristics in brief**

Rated voltage $V_R$	200 ... 450 V DC					
Surge voltage $V_S$	$V_R \leq 250$ V DC: $1.15 \cdot V_R$ (at room temperature) $V_R > 250$ V DC: $1.1 \cdot V_R$ (at room temperature)					
Rated capacitance $C_R$	1.0 ... 100 $\mu$ F					
Capacitance tolerance	$\pm 20\% \triangleq M$					
Dissipation factor (max.) (20 °C, 120 Hz)	$V_R$ (V DC)	200	250	350	400	450
	$\tan \delta$	0.15	0.15	0.15	0.20	0.24
Leakage current $I_{leak}$ (20 °C, after 5 minutes)	$I_{leak} \leq 0.02 \mu A \cdot \left( \frac{C_R}{\mu F} \cdot \frac{V_R}{V} \right) + 25 \mu A$					
Useful life 105 °C; $V_R$ ; $I_{AC,R}$	> 10000 h					
Requirements	$\Delta C/C \leq \pm 20\%$ of initial value $\tan \delta \leq 2$ times initial specified limit $I_{leak} \leq$ initial specified limit					
Shelf life	After storage for 1000 h at 105 °C, the capacitors shall meet the requirement of load life test after reforming process. After test: $V_R$ to be applied for 30 minutes, 24 to 48 hours before measurement.					
Low temperature stability (impedance ratio) (120 Hz)	$V_R$ (V DC)	200	250	350	400	450
	$Z (-25^\circ C)$ $Z (+20^\circ C)$	3	3	4	6	8
Vibration resistance test	To IEC 60068-2-6, test Fc: Frequency range 10 ... 55 Hz, displacement amplitude 0.75 mm, acceleration max. 10 g, duration $3 \times 2$ h. If can size D <16 mm, capacitor is mounted by the leads If can size D $\geq$ 16 mm, capacitor rigidly clamped by the aluminum case					
IEC climatic category	To IEC 60068-1: 25/105/56 (-25 °C/+105 °C/56 days damp heat test)					

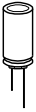

**B43086**

**High temperature – 105 °C**

**Dimensional drawing**

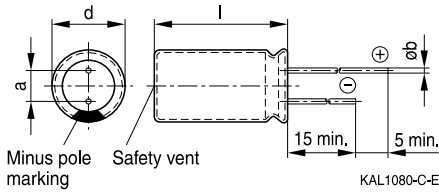

**Case Dimensions**

$d \times l$ mm	$d_{max} \times l_{max}$ mm	a mm	b mm
10 × 12.5	11.0 × 13.0	5.0 ±0.5	0.6 ±0.1
10 × 16	11.0 × 17.5	5.0 ±0.5	0.6 ±0.1
10 × 20	11.0 × 22.0	5.0 ±0.5	0.6 ±0.1
12.5 × 20	13.5 × 22.0	5.0 ±0.5	0.6 ±0.1
12.5 × 25	13.5 × 27.0	5.0 ±0.5	0.6 ±0.1
16 × 20	17.0 × 22.0	7.5 ±0.5	0.8 ±0.1
16 × 25	17.0 × 27.0	7.5 ±0.5	0.8 ±0.1
16 × 31.5	17.0 × 33.5	7.5 ±0.5	0.8 ±0.1

**Overview of available types**

$V_R$ (V DC)	200	250	350	400	450
	Case dimensions $d \times l$ (mm)				
$C_R$ ( $\mu\text{F}$ )					
1.0				10 × 12.5	
1.5				10 × 12.5	
2.2				10 × 12.5	
3.3				10 × 16	
4.7			10 × 12.5	10 × 16	10 × 20
5.6			10 × 16	10 × 20	10 × 20
6.8		10 × 12.5	10 × 16	10 × 20	10 × 20
10	10 × 16	10 × 16	10 × 20	12.5 × 20	12.5 × 20
15	10 × 20	10 × 20		12.5 × 20	12.5 × 25
22	10 × 20	12.5 × 20	12.5 × 25	12.5 × 25	16 × 25
33	12.5 × 20	12.5 × 25	16 × 20	16 × 25	16 × 31.5
47	12.5 × 20	16 × 20	16 × 25	16 × 31.5	
68	12.5 × 25	16 × 25			
82	16 × 20	16 × 31.5			
100	16 × 25				

**B43086**
**High temperature – 105 °C**
**Technical data and ordering codes**

$C_R$ 120 Hz, 20 °C $\mu\text{F}$	Case dimensions $d \times l$ mm	$I_{AC,R}$ 100 kHz, 105 °C mA	Ordering code (composition see below)
<b><math>V_R = 200 \text{ V DC}</math></b>			
10	10 × 16	200	B43086A2106M***
15	10 × 20	320	B43086A2156M***
22	10 × 20	400	B43086A2226M***
33	12.5 × 20	480	B43086A2336M***
47	12.5 × 20	528	B43086A2476M***
68	12.5 × 25	608	B43086A2686M***
82	16 × 20	720	B43086A2826M***
100	16 × 25	880	B43086A2107M***
<b><math>V_R = 250 \text{ V DC}</math></b>			
6.8	10 × 12.5	176	B43084F2685M***
10	10 × 16	208	B43086F2106M***
15	10 × 20	320	B43086F2156M***
22	12.5 × 20	456	B43086F2226M***
33	12.5 × 25	520	B43086F2336M***
47	16 × 20	576	B43086F2476M***
68	16 × 25	800	B43086F2686M***
82	16 × 31.5	880	B43086F2826M***
<b><math>V_R = 350 \text{ V DC}</math></b>			
4.7	10 × 12.5	120	B43086A4475M***
5.6	10 × 16	136	B43086A4565M***
6.8	10 × 16	176	B43086A4685M***
10	10 × 20	208	B43086A4106M***
22	12.5 × 25	280	B43086A4226M***
33	16 × 20	400	B43086A4336M***
47	16 × 25	520	B43086A4476M***

**Composition of ordering code**

\*\*\* = Version

000 = for standard leads, bulk

001 = for kinked leads, bulk

002 = for cut leads, bulk

 008 = for taped leads, Ammo pack, lead spacing F = 5.0 mm (for  $\varnothing$  10 ... 12.5 mm)

 009 = for taped leads, Ammo pack, lead spacing F = 7.5 mm (for  $\varnothing$  16 mm)

**Technical data and ordering codes**

$C_R$ 120 Hz, 20 °C $\mu\text{F}$	Case dimensions $d \times l$ mm	$I_{AC,R}$ 100 kHz, 105 °C mA	Ordering code (composition see below)
<b><math>V_R = 400 \text{ V DC}</math></b>			
1	10 × 12.5	56	B43086A9105M***
1.5	10 × 12.5	68	B43086A9155M***
2.2	10 × 12.5	80	B43086B9225M***
3.3	10 × 16	104	B43086B9335M***
4.7	10 × 16	144	B43086B9475M***
5.6	10 × 20	160	B43086A9565M***
6.8	10 × 20	176	B43086B9685M***
10	12.5 × 20	200	B43086B9106M***
15	12.5 × 20	280	B43086A9156M***
22	12.5 × 25	320	B43086A9226M***
33	16 × 25	480	B43086A9336M***
47	16 × 31.5	640	B43086A9476M***
<b><math>V_R = 450 \text{ V DC}</math></b>			
4.7	10 × 20	100	B43086A5475M***
5.6	10 × 20	112	B43086A5565M***
6.8	10 × 20	120	B43086A5685M***
10	12.5 × 20	240	B43086A5106M***
15	12.5 × 25	320	B43086A5156M***
22	16 × 25	440	B43086A5226M***
33	16 × 31.5	560	B43086A5336M***

**Composition of ordering code**

\*\*\* = Version

000 = for standard leads, bulk

001 = for kinked leads, bulk

002 = for cut leads, bulk

008 = for taped leads, Ammo pack, lead spacing  $F = 5.0 \text{ mm}$  (for  $\varnothing 10 \dots 12.5 \text{ mm}$ )

009 = for taped leads, Ammo pack, lead spacing  $F = 7.5 \text{ mm}$  (for  $\varnothing 16 \text{ mm}$ )

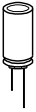

**B43086**

**High temperature – 105 °C**

**Useful life**

depending on ambient temperature  $T_A$  under ripple current operating conditions<sup>1)</sup>

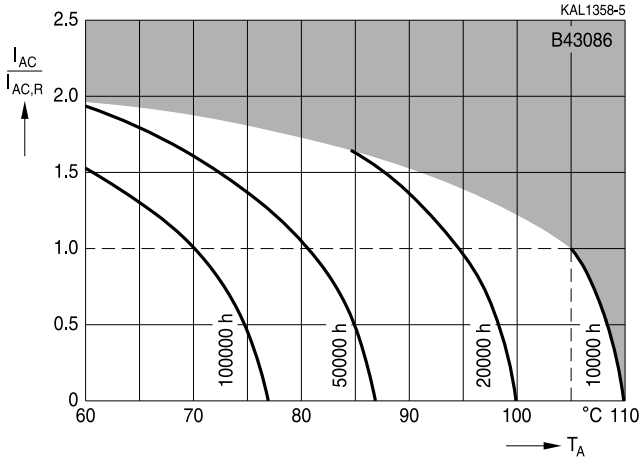

**Frequency factor of permissible ripple current  $I_{AC}$  versus frequency  $f$**

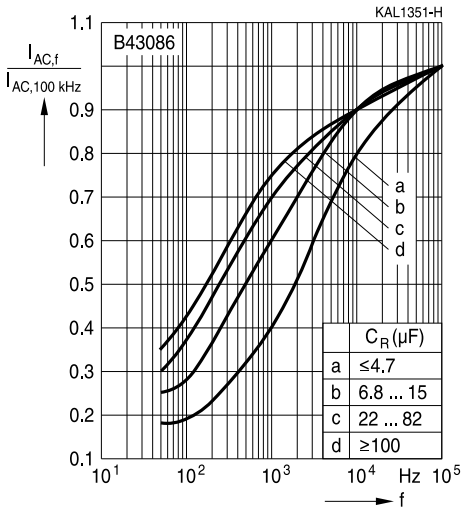

1) Refer to chapter "General technical information, 5.3 Calculation of useful life" for an explanation on how to interpret the useful life graphs.



## Taping, packing and lead configurations

### Taping

Single-ended capacitors are available taped in Ammo pack from diameter 4 to 18 mm as follows:

Lead spacing  $F = 2.0$  mm ( $\varnothing d = 4 \dots 5$  mm)

Lead spacing  $F = 2.5$  mm ( $\varnothing d = 4 \dots 6.3$  mm)

Lead spacing  $F = 3.5$  mm ( $\varnothing d = 8$  mm)

Lead spacing  $F = 5.0$  mm ( $\varnothing d = 4 \dots 12.5$  mm)

Lead spacing  $F = 7.5$  mm ( $\varnothing d = 16 \dots 18$  mm).

### Lead spacing 2.0 mm ( $\varnothing d = 4 \dots 5$ mm)

Last 3 digits of ordering code: 016

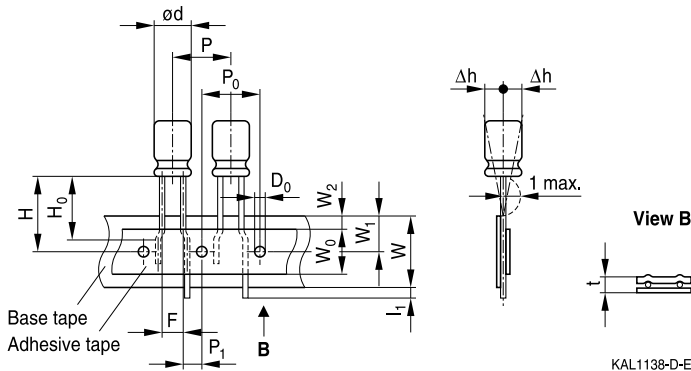

### Dimensions in mm

$\varnothing d$	F	H	W	$W_0$	$W_1$	$W_2$	P	$P_0$	$P_1$	$l_1$	t	$\Delta h$	$D_0$
4 ... 5	2.0	18.5	18.0	7.0	9.0	3.0	12.7	12.7	5.10	1.0	0.7	1	4.0
	+0.8 -0.2	±0.75	±0.5	min.	±0.5	max.	±1.0	±0.3	±0.7	max.	±0.2	±1.0	±0.2

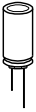

**B43086**

**High temperature – 105 °C**

**Lead spacing 2.5 mm (∅ d = 4 ... 6.3 mm)**

Last 3 digits of ordering code: 007

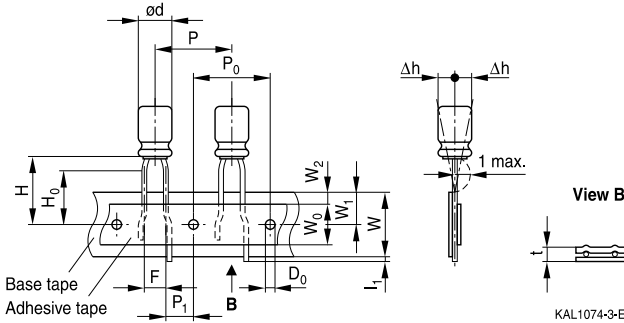

**Dimensions in mm**

∅ d	F	H	W	W <sub>0</sub>	W <sub>1</sub>	W <sub>2</sub>	H <sub>0</sub>	P	P <sub>0</sub>	P <sub>1</sub>	l <sub>1</sub>	t	Δh	D <sub>0</sub>
4 ... 6.3	2.5	18.5	18.0	5.5	9.0	1.5	16.0	12.7	12.7	5.1	1.0	0.7	1.0	4.0
Tolerance	+0.8 -0.2	±0.75	±0.5	min.	±0.5	max.	±0.5	±1.0	±0.2	±0.5	max.	±0.2	max.	±0.2

**Lead spacing 3.5 mm (∅ d = 8 mm)**

Last 3 digits of ordering code: 006

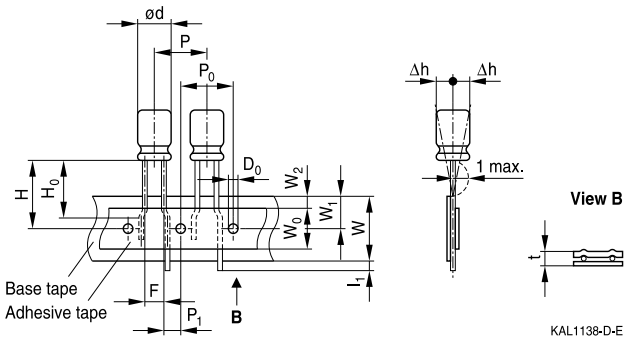

**Dimensions in mm**

∅ d	F	H	W	W <sub>0</sub>	W <sub>1</sub>	W <sub>2</sub>	P	P <sub>0</sub>	P <sub>1</sub>	l <sub>1</sub>	t	Δh	D <sub>0</sub>
8	3.5	18.5	18.0	10	9.0	3.0	12.7	12.7	4.6	1.0	0.7	1.0	4.0
Tolerance	+0.8 -0.2	±1.0	±0.5	min.	±0.5	max.	±1.0	±0.3	±0.6	max.	±0.2	max.	±0.2

Leads can also run straight through the taping area. Taping is available up to dimensions  $d \times l = 8 \times 15$  mm.

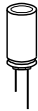

B43086

High temperature – 105 °C

**Lead spacing 5.0 mm (∅ d = 4 ... 8 mm)**

Last 3 digits of ordering code: 008

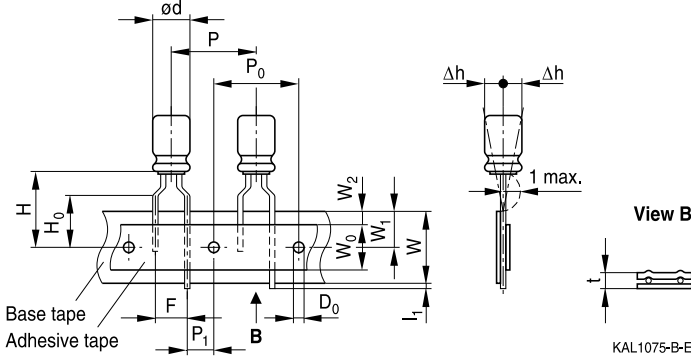

**Lead spacing 5.0 mm (∅ d = 10 ... 12.5 mm)**

Last 3 digits of ordering code: 008

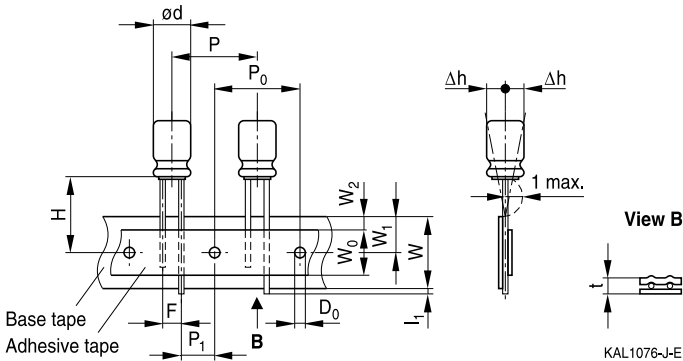

**Dimensions in mm**

∅ d	F	H	W	W <sub>0</sub>	W <sub>1</sub>	W <sub>2</sub>	H <sub>0</sub>	P	P <sub>0</sub>	P <sub>1</sub>	l <sub>1</sub>	t	Δh	D <sub>0</sub>
4 ... 6.3	5.0	18.5	18.0	5.5	9.0	1.5	16.0	12.7	12.7	3.85	1.0	0.6	1.0	4.0
8	5.0	20.0	18.0	10.0	9.0	1.5	16.0	12.7	12.7	3.85	1.0	0.6	1.0	4.0
		19.0		12.5			12.7	3.85						
10	5.0	19.0	18.0	12.5	9.0	1.5	—	12.7	12.7	3.85	1.0	0.6	1.0	4.0
12.5	5.0	19.0	18.0	12.5	9.0	1.5	—	15.0	15.0	5.0	1.0	0.6	1.0	4.0
Tolerance	+0.8 -0.2	±0.75	±0.5	min.	±0.5	max.	±0.5	±1.0	±0.2	±0.5	max.	+0.3 -0.2	max.	±0.2

Taping is available up to dimensions d × l = 10 × 31.5 mm and 12.5 × 25 mm.

Taping is not available for d × l = 8 × 20 mm.

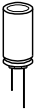

**B43086**

**High temperature – 105 °C**

**Lead spacing 7.5 mm (∅ d = 16 ...18 mm)**

Last 3 digits of ordering code: 009

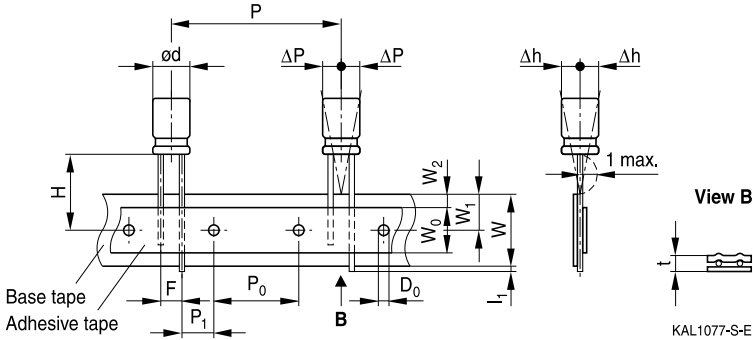

**Dimensions in mm**

∅ d	F	H	W	W <sub>0</sub>	W <sub>1</sub>	W <sub>2</sub>	P	P <sub>0</sub>	P <sub>1</sub>	I <sub>1</sub>	t	ΔP	Δh	D <sub>0</sub>
16	7.5	18.5	18.0	12.5	9.0	1.5	30.0	15.0	3.75	1.0	0.7	0	0	4.0
18														
Tolerance	±0.8	-0.5 +0.75	±0.5	min.	±0.5	max.	±1.0	±0.2	±0.5	max.	±0.2	±1.0	±1.0	±0.2

Taping is available up to dimensions d × l = 16 × 31.5 mm and 18 × 31.5 mm.



### Cut or kinked leads

Single-ended capacitors are available with cut or kinked leads. Other lead configurations also available upon request.

### Cut leads (Chapter A)

Available for series B41002, B41022, B41044, B41827, B41828, B43044, B43082, B43086, B43088, B43827, B43828.

Last 3 digits of ordering code: 002

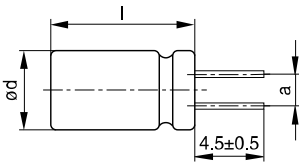

KAL1086-R

Case size d x l (mm)	Dimensions (mm) a ±0.5
4 x 7	1.5
5 x 7	2.0
5 x 11	2.0
6.3 x 7	2.5
6.3 x 11	2.5
8 x 7	3.5
8 x 11.5	3.5
8 x 15	3.5
8 x 20	3.5
10 x 12.5	5.0
10 x 16	5.0
10 x 20	5.0
10 x 25	5.0
10 x 31.5	5.0

Case size d x l (mm)	Dimensions (mm) a ±0.5
12.5 x 16	5.0
12.5 x 20	5.0
12.5 x 25	5.0
12.5 x 31.5	5.0
12.5 x 35.5	5.0
12.5 x 40	5.0
16 x 20	7.5
16 x 25	7.5
16 x 31.5	7.5
16 x 35.5	7.5
16 x 40	7.5
18 x 20	7.5
18 x 25	7.5
18 x 31.5	7.5
18 x 35.5	7.5
18 x 40	7.5

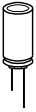

**B43086**

**High temperature – 105 °C**

**Cut leads (Chapter B)**

Available for series B41858, B41859, B41863, B41866, B41868, B41888, B41890, B41896, B42824, B42851, B43866, B43867, B43890, B43896.

Last 3 digits of ordering code: 002

**With stand-off rubber seal**

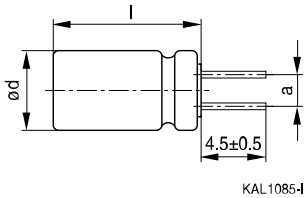

**With flat rubber seal**

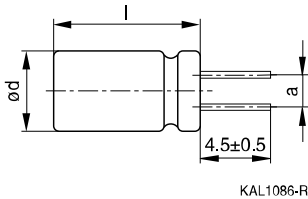

Case size d × l (mm)	Dimensions (mm) a ±0.5
10 × 12.5	5.0
10 × 16	5.0
10 × 20	5.0
12.5 × 20	5.0
12.5 × 25	5.0
16 × 20	7.5
16 × 25	7.5
16 × 31.5	7.5
16 × 35.5	7.5
18 × 20	7.5
18 × 25	7.5
18 × 31.5	7.5
18 × 35	7.5
18 × 40	7.5



### Kinked leads (Chapter A)

Available for series B41002, B41022, B41044, B41827, B41828, B43044, B43082, B43086, B43088, B43827, B43828.

Last 3 digits of ordering code: 001

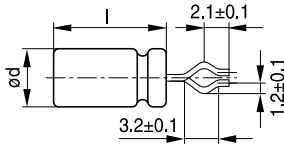

KAL1137-5

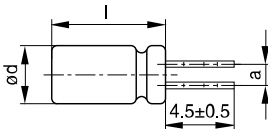

KAL1084-A

Case size d x l (mm)	Dimensions (mm) a ±0.5
4 x 7	1.5
5 x 7	2.0
5 x 11	2.0
6.3 x 7	2.5
6.3 x 11	2.5
8 x 7	3.5
8 x 11.5	3.5
8 x 15	3.5
8 x 20	3.5
10 x 12.5	5.0
10 x 16	5.0
10 x 20	5.0
10 x 25	5.0
10 x 31.5	5.0

Case size d x l (mm)	Dimensions (mm) a ±0.5
12.5 x 16	5.0
12.5 x 20	5.0
12.5 x 25	5.0
12.5 x 31.5	5.0
12.5 x 35.5	5.0
12.5 x 40	5.0
16 x 20	7.5
16 x 25	7.5
16 x 31.5	7.5
16 x 35.5	7.5
16 x 40	7.5
18 x 20	7.5
18 x 25	7.5
18 x 31.5	7.5
18 x 35.5	7.5
18 x 40	7.5

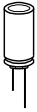

**B43086**

**High temperature – 105 °C**

**Kinked leads (Chapter B)**

Available for series B41858, B41859, B41863, B41866, B41868, B41888, B41890, B41896, B42824, B42851, B43866, B43867, B43890, B43896.

Last 3 digits of ordering code: 001

**With stand-off rubber seal**

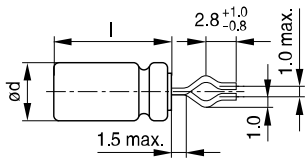

KAL1081-K

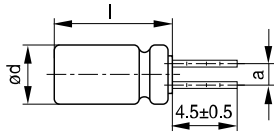

KAL1083-2

**With flat rubber seal**

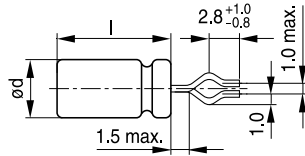

KAL1082-T

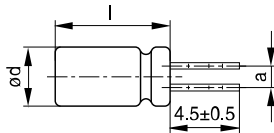

KAL1084-A

Case size $d \times l$ (mm)	Dimensions (mm) $a \pm 0.5$
10 × 20	5.0
12.5 × 20	5.0
12.5 × 25	5.0
16 × 20	7.5
16 × 25	7.5
16 × 31.5	7.5
16 × 35.5	7.5
18 × 20	7.5
18 × 25	7.5
18 × 31.5	7.5
18 × 35	7.5
18 × 40	7.5



### PAPR leads (Protection Against Polarity Reversal)

These lead configurations ensure correct placement of the capacitor on the PCB with regard to polarity. PAPR leads are available for diameters from 10 mm up to 18 mm.

There are three configurations available: Crimped leads, J leads, bent 90° leads

Available for series B41858, B41859, B41863, B41866, B41868, B41888, B41890, B41896, B42824, B42851, B43866, B43867, B43890, B43896.

### Crimped leads

Last 3 digits of ordering code: 003

#### With stand-off rubber seal

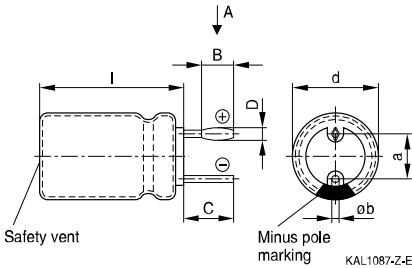

#### With flat rubber seal

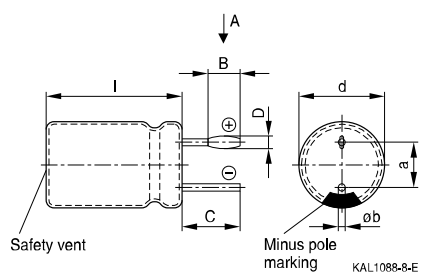

### Suggestion for PCB hole diameter

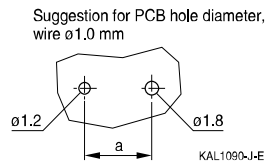
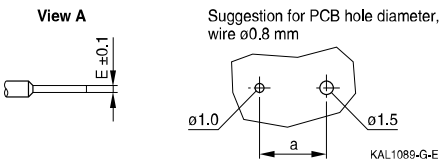

Case size d × l (mm)	Dimensions (mm)					
	B ±0.2	C ±0.5	D ±0.1	E ±0.1	a ±0.5	∅b
16 × 20	1.5	3.0	1.3	0.3	7.5	0.8 ±0.05
16 × 25	1.5	3.0	1.3	0.3	7.5	0.8 ±0.05
16 × 31.5	1.5	3.0	1.3	0.3	7.5	0.8 ±0.05
16 × 35.5	1.5	3.0	1.3	0.3	7.5	0.8 ±0.05
18 × 20	1.5	3.0	1.3	0.3	7.5	0.8 ±0.1
18 × 25	1.5	3.0	1.3	0.3	7.5	0.8 ±0.1
18 × 31.5	1.5	3.0	1.3	0.3	7.5	0.8 ±0.1
18 × 35	1.5	3.0	1.3	0.3	7.5	0.8 ±0.1
18 × 40	1.5	3.0	1.3	0.3	7.5	0.8 ±0.1

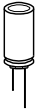

**B43086**

**High temperature – 105 °C**

**J leads**

Last 3 digits of ordering code: 004

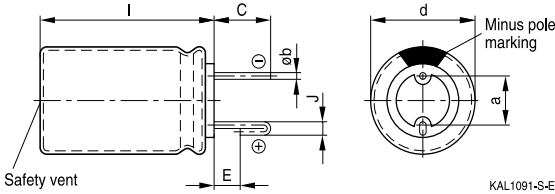

**Suggestion for PCB hole diameter**

Suggestion for PCB hole diameter, wire  $\varnothing 0.6$  mm

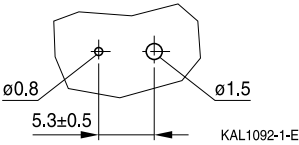

Suggestion for PCB hole diameter, wire  $\varnothing 0.8$  mm

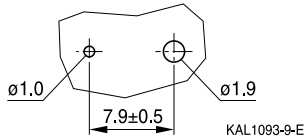

Case size $d \times l$ (mm)	Dimensions (mm)				
	$C \pm 0.5$	$E \pm 0.5$	$J \pm 0.2$	$a \pm 0.5$	$\varnothing b$
10 × 12.5	3.2	0.7	1.2	5.0	$0.6 \pm 0.05$
10 × 16	3.2	0.7	1.2	5.0	$0.6 \pm 0.05$
10 × 20	3.2	0.7	1.2	5.0	$0.6 \pm 0.05$
12.5 × 20	3.2	0.7	1.2	5.0	$0.6 \pm 0.05$
12.5 × 25	3.2	0.7	1.2	5.0	$0.6 \pm 0.05$
16 × 20	3.5	0.7	1.6	7.5	$0.8 \pm 0.05$
16 × 25	3.5	0.7	1.6	7.5	$0.8 \pm 0.05$
16 × 31.5	3.5	0.7	1.6	7.5	$0.8 \pm 0.05$
16 × 35.5	3.5	0.7	1.6	7.5	$0.8 \pm 0.05$
18 × 20	3.5	0.7	1.6	7.5	$0.8 \pm 0.1$
18 × 25	3.5	0.7	1.6	7.5	$0.8 \pm 0.1$
18 × 31.5	3.5	0.7	1.6	7.5	$0.8 \pm 0.1$
18 × 35	3.5	0.7	1.6	7.5	$0.8 \pm 0.1$

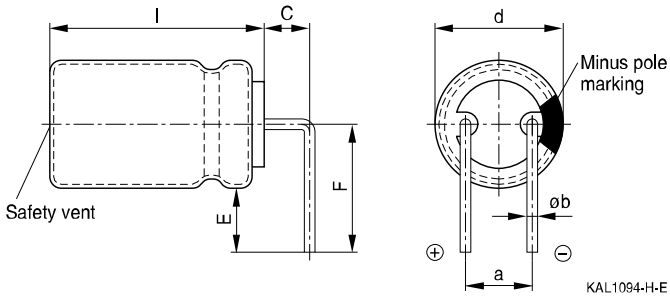

**Bent 90° leads for horizontal mounting pinning**

Last 3 digits of ordering code: 012

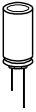

Case size d × l (mm)	Dimensions (mm)				
	C ±0.5	E ±0.5	F ±0.5	a ±0.5	Øb
16 × 20	4.0	4.0	12.0	7.5	0.8 ±0.05
16 × 25	4.0	4.0	12.0	7.5	0.8 ±0.05
16 × 31.5	4.0	4.0	12.0	7.5	0.8 ±0.05
16 × 35.5	4.0	4.0	12.0	7.5	0.8 ±0.05
18 × 20	4.0	4.0	13.0	7.5	0.8 ±0.1
18 × 25	4.0	4.0	13.0	7.5	0.8 ±0.1
18 × 31.5	4.0	4.0	13.0	7.5	0.8 ±0.1
18 × 35	4.0	4.0	13.0	7.5	0.8 ±0.1
18 × 40	4.0	4.0	13.0	7.5	0.8 ±0.1

Bent leads for diameter 12.5 mm available upon request.



**B43086**

**High temperature – 105 °C**

**Packing units and box dimensions**

**Ammo pack**

Valid for series B41002, B41022, B41044, B41827, B41828, B43044, B43082, B43086, B43088, B43827, B43828.

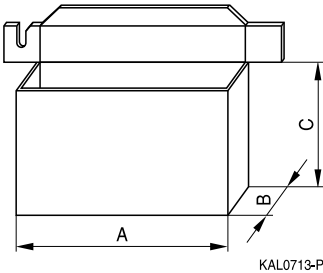

Case size d × l mm	Dimensions (mm)			Packing units pcs.
	A <sub>max</sub>	B <sub>max</sub>	C <sub>max</sub>	
4 × 7	330	50	196	2000
5 × 7	330	50	226	2000
5 × 11	330	50	226	2000
6.3 × 7	330	50	286	2000
6.3 × 11	330	50	286	2000
8 × 7	330	50	246	1000
8 × 11.5	330	50	246	1000
8 × 15	330	50	246	500
10 × 12.5	330	50	196	500
10 × 16	330	54	196	500
10 × 20	330	58	196	500
12.5 × 20	341	60	272	500
12.5 × 25	341	65	272	500
16 × 25	320	65	270	300
16 × 31.5	315	65	275	300
18 × 20	315	65	275	250
18 × 25	315	65	275	250
18 × 31.5	315	65	275	250

**Ammo pack**

Valid for series B41858, B41859, B41863, B41866, B41868, B41888, B41890, B41896, B42824, B42851, B43866, B43867, B43890, B43896.

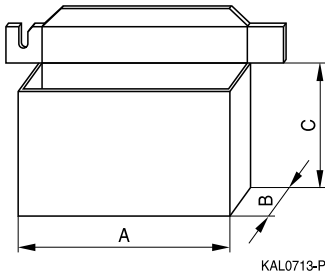

Case size d × l mm	Dimensions (mm)			Packing units pcs.
	A <sub>max</sub>	B <sub>max</sub>	C <sub>max</sub>	
8 × 11.5	345	55	240	1000
10 × 12.5	345	55	280	750
10 × 16	345	60	200	500
10 × 20	345	60	200	500
12.5 × 20	345	65	280	500
12.5 × 25	345	65	280	500
16 × 20	315	65	275	300
16 × 25	315	65	275	300
16 × 31.5	315	65	275	300
18 × 20	315	65	275	250
18 × 25	315	65	275	250
18 × 31.5	315	65	275	250

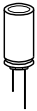

**B43086**

**High temperature – 105 °C**

**Overview of packing units and code numbers for case sizes 4 x 7 ... 16 x 40**

Valid for series B41002, B41022, B41044, B41827, B41828, B43044, B43082, B43086, B43088, B43827, B43828.

Case size d x l mm	Standard, bulk pcs.	Taped, Ammo pack pcs.	Kinked leads, bulk pcs.	Cut leads, bulk pcs.		
4 x 7	10000	2000	15000	15000		
5 x 7	7500	2000	10000	10000		
5 x 11	5000	2000	10000	10000		
6.3 x 7	5000	2000	10000	10000		
6.3 x 11	5000	2000	5000	5000		
8 x 7	5000	1000	5000	5000		
8 x 11.5	2500	1000	4000	4000		
8 x 15	2000	1000	2500	2500		
8 x 20	1500	–	2000	2000		
10 x 12.5	2000	500	2500	2500		
10 x 16	1500	500	2000	2000		
10 x 20	1000	500	1500	1500		
10 x 25	1000	500	1250	1250		
12.5 x 16	750	500	1000	1000		
12.5 x 20	750	500	500	500		
12.5 x 25	750	500	500	500		
12.5 x 31.5	500	–	750	750		
12.5 x 35.5	500	–	750	750		
12.5 x 40	500	–	750	750		
16 x 20	375	300	500	500		
16 x 25	375	300	500	500		
16 x 31.5	250	300	375	375		
16 x 35.5	250	–	375	375		
16 x 40	250	–	375	375		
The last three digits of the complete ordering code state the lead configuration	<b>000</b>	Code	F (mm)	d (mm)	<b>001</b>	<b>002</b>
		006	3.5	8		
		007	2.5	4 ... 6.3		
		008	5.0	4 ... 12.5		
		009	7.5	16 ... 18		
		016	2.0	4 ... 5		

**Overview of packing units and code numbers for case sizes 18 x 20 ... 18 x 40**

Valid for series B41002, B41022, B41044, B41827, B41828, B43044, B43082, B43086, B43088, B43827, B43828.

Case size d x l mm	Standard, bulk pcs.	Taped, Ammo pack pcs.			Kinked leads, bulk pcs.	Cut leads, bulk pcs.
18 x 20	250	250			100	100
18 x 25	250	250			100	100
18 x 31.5	250	250			100	100
18 x 35.5	250	–			100	100
18 x 40	250	–			100	100
The last three digits of the complete ordering code state the lead configuration	<b>000</b>	Code	F (mm)	d (mm)	<b>001</b>	<b>002</b>
		009	7.5	16 ... 18		

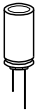

**B43086**

**High temperature – 105 °C**

**Overview of packing units and code numbers for case sizes 8 × 11.5 ... 16 × 35.5**

Valid for series B41858, B41859, B41863, B41866, B41868, B41888, B41890, B41896, B42824, B42851, B43866, B43867, B43890, B43896.

					<b>PAPR</b>				
Case size d × l	Standard, bulk	Taped, Ammo pack		Kinked leads, bulk	Cut leads, bulk	Crimped leads, blister	J leads, blister	Bent 90° leads, blister	
mm	pcs.	pcs.		pcs.	pcs.	pcs.	pcs.	pcs.	
8 × 11.5	1000	1000		–	–	–	–		
10 × 12.5	1000	750		–	1000	–	675		
10 × 16	1000	500		–	1000	–	675		
10 × 20	500	500		500	500	–	500		
12.5 × 20	350	500		350	350	–	300	1)	
12.5 × 25	250	500		500	500	–	225	1)	
12.5 × 30	200	–		–	–	–	–		
12.5 × 35	175	–		–	–	–	–		
12.5 × 40	175	–		–	–	–	–		
16 × 20	250	300		200	200	200	200	120	
16 × 25	250	300		200	200	200	200	120	
16 × 31.5	200	300		250	250	344	344	120	
16 × 35.5	100	–		100	100	150	150	150	
The last three digits of the complete ordering code state the lead configuration	<b>000</b>	Code	F (mm)	d (mm)	<b>001</b>	<b>002</b>	<b>003</b>	<b>004</b>	<b>012</b>
		<b>006</b>	3.5	8					
		<b>008</b>	5	5...12.5					
		<b>009</b>	7.5	16...18					

1) Available upon request

**Overview of packing units and code numbers for case sizes 18 × 20 ... 18 × 40**

Valid for series B41858, B41859, B41863, B41866, B41868, B41888, B41890, B41896, B42824, B42851, B43866, B43867, B43890, B43896.

					<b>PAPR</b>				
Case size d × l  mm	Standard, bulk pcs.	Taped, Ammo pack pcs.			Kinked leads, bulk pcs.	Cut leads, bulk pcs.	Crimped leads, blister pcs.	J leads, blister pcs.	Bent 90° leads, blister pcs.
18 × 20	175	250			175	175	200	200	120
18 × 25	150	250			150	150	200	200	120
18 × 31.5	100	250			100	100	150	150	120
18 × 35	100	–			100	100	150	150	150
18 × 40	125	–			100	100	120	–	72
The last three digits of the complete ordering code state the lead configuration	<b>000</b>	Code	F (mm)	d (mm)	<b>001</b>	<b>002</b>	<b>003</b>	<b>004</b>	<b>012</b>
		<b>009</b>	7.5	16...18					

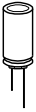

**B43086**

**High temperature – 105 °C**

## Cautions and warnings

### Personal safety

The electrolytes used by EPCOS have not only been optimized with a view to the intended application, but also with regard to health and environmental compatibility. They do not contain any solvents that are detrimental to health, e.g. dimethyl formamide (DMF) or dimethyl acetamide (DMAC).

Furthermore, part of the high-voltage electrolytes used by EPCOS are self-extinguishing. They contain flame-retarding substances which will quickly extinguish any flame that may have been ignited.

As far as possible, EPCOS does not use any dangerous chemicals or compounds to produce operating electrolytes. However, in exceptional cases, such materials must be used in order to achieve specific physical and electrical properties because no safe substitute materials are currently known. However, the amount of dangerous materials used in our products has been limited to an absolute minimum. Nevertheless, the following rules should be observed when handling aluminum electrolytic capacitors:

- Any escaping electrolyte should not come into contact with eyes or skin.
- If electrolyte does come into contact with the skin, wash the affected parts immediately with running water. If the eyes are affected, rinse them for 10 minutes with plenty of water. If symptoms persist, seek medical treatment.
- Avoid breathing in electrolyte vapor or mists. Workplaces and other affected areas should be well ventilated. Clothing that has been contaminated by electrolyte must be changed and rinsed in water.



## Product safety

The table below summarizes the safety instructions that must be observed without fail. A detailed description can be found in the relevant sections of chapter "General technical information".

Topic	Safety information	Reference chapter "General technical information"
Polarity	Make sure that polar capacitors are connected with the right polarity.	1 "Basic construction of aluminum electrolytic capacitors"
Reverse voltage	Voltages polarity classes should be prevented by connecting a diode.	3.1.6 "Reverse voltage"
Upper category temperature	Do not exceed the upper category temperature.	7.2 "Maximum permissible operating temperature"
Maintenance	Make periodic inspections of the capacitors. Before the inspection, make sure that the power supply is turned off and carefully discharge the electricity of the capacitors. Do not apply any mechanical stress to the capacitor terminals.	10 "Maintenance"
Mounting position of screw-terminal capacitors	Do not mount the capacitor with the terminals (safety vent) upside down.	11.1. "Mounting positions of capacitors with screw terminals"
Mounting of single-ended capacitors	The internal structure of single-ended capacitors might be damaged if excessive force is applied to the lead wires. Avoid any compressive, tensile or flexural stress. Do not move the capacitor after soldering to PC board. Do not pick up the PC board by the soldered capacitor. Do not insert the capacitor on the PC board with a hole space different to the lead space specified.	11.4 "Mounting considerations for single-ended capacitors"
Robustness of terminals	The following maximum tightening torques must not be exceeded when connecting screw terminals: M5: 2 Nm M6: 2.5 Nm	11.3 "Mounting torques"
Soldering	Do not exceed the specified time or temperature limits during soldering.	11.5 "Soldering"



**B43086**

**High temperature – 105 °C**

Topic	Safety information	Reference chapter "General technical information"
Soldering, cleaning agents	Do not allow halogenated hydrocarbons to come into contact with aluminum electrolytic capacitors.	11.6 "Cleaning agents"
Passive flammability	Avoid external energy, such as fire or electricity.	8.1 "Passive flammability"
Active flammability	Avoid overload of the capacitors.	8.2 "Active flammability"
		Reference chapter "Capacitors with screw terminals"
Breakdown strength of insulating sleeves	Do not damage the insulating sleeve, especially when ring clips are used for mounting.	"Screw terminals – accessories"

**Symbols and terms**

Symbol	English	German
C	Capacitance	Kapazität
$C_R$	Rated capacitance	Nennkapazität
$C_S$	Series capacitance	Serienkapazität
$C_{S,T}$	Series capacitance at temperature T	Serienkapazität bei Temperatur T
$C_f$	Capacitance at frequency f	Kapazität bei Frequenz f
d	Case diameter, nominal dimension	Gehäusedurchmesser, Nennmaß
$d_{max}$	Maximum case diameter	Maximaler Gehäusedurchmesser
ESL	Self-inductance	Eigeninduktivität
ESR	Equivalent series resistance	Ersatzserienwiderstand
$ESR_f$	Equivalent series resistance at frequency f	Ersatzserienwiderstand bei Frequenz f
$ESR_T$	Equivalent series resistance at temperature T	Ersatzserienwiderstand bei Temperatur T
f	Frequency	Frequenz
I	Current	Strom
$I_{AC}$	Alternating current (ripple current)	Wechselstrom
$I_{AC,rms}$	Root-mean-square value of alternating current	Wechselstrom, Effektivwert
$I_{AC,f}$	Ripple current at frequency f	Wechselstrom bei Frequenz f
$I_{AC,max}$	Maximum permissible ripple current	Maximal zulässiger Wechselstrom
$I_{AC,R}$	Rated ripple current	Nennwechselstrom
$I_{AC,R} (B)$	Rated ripple current for base cooling	Nennwechselstromstrom für Bodenkühlung
$I_{leak}$	Leakage current	Reststrom
$I_{leak,op}$	Operating leakage current	Betriebsreststrom
l	Case length, nominal dimension	Gehäuselänge, Nennmaß
$l_{max}$	Maximum case length (without terminals and mounting stud)	Maximale Gehäuselänge (ohne Anschlüsse und Gewindebolzen)
R	Resistance	Widerstand
$R_{ins}$	Insulation resistance	Isolationswiderstand
$R_{symm}$	Balancing resistance	Symmetrierwiderstand
T	Temperature	Temperatur
$\Delta T$	Temperature difference	Temperaturdifferenz
$T_A$	Ambient temperature	Umgebungstemperatur
$T_C$	Case temperature	Gehäusetemperatur
$T_B$	Capacitor base temperature	Temperatur des Becherbodens
t	Time	Zeit
$\Delta t$	Period	Zeitraum
$t_b$	Service life (operating hours)	Brauchbarkeitsdauer (Betriebszeit)

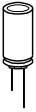

**B43086**

**High temperature – 105 °C**

Symbol	English	German
V	Voltage	Spannung
V <sub>F</sub>	Forming voltage	Formierspannung
V <sub>op</sub>	Operating voltage	Betriebsspannung
V <sub>R</sub>	Rated voltage, DC voltage	Nennspannung, Gleichspannung
V <sub>S</sub>	Surge voltage	Spitzenspannung
X <sub>C</sub>	Capacitive reactance	Kapazitiver Blindwiderstand
X <sub>L</sub>	Inductive reactance	Induktiver Blindwiderstand
Z	Impedance	Scheinwiderstand
Z <sub>T</sub>	Impedance at temperature T	Scheinwiderstand bei Temperatur T
tan δ	Dissipation factor	Verlustfaktor
λ	Failure rate	Ausfallrate
ε <sub>0</sub>	Absolute permittivity	Elektrische Feldkonstante
ε <sub>r</sub>	Relative permittivity	Dielektrizitätszahl
ω	Angular velocity; 2 · π · f	Kreisfrequenz; 2 · π · f

**Note**

All dimensions are given in mm.



## Important notes

The following applies to all products named in this publication:





1. Some parts of this publication contain **statements about the suitability of our products for certain areas of application**. These statements are based on our knowledge of typical requirements that are often placed on our products in the areas of application concerned. We nevertheless expressly point out **that such statements cannot be regarded as binding statements about the suitability of our products for a particular customer application**. As a rule we are either unfamiliar with individual customer applications or less familiar with them than the customers themselves. For these reasons, it is always ultimately incumbent on the customer to check and decide whether a product with the properties described in the product specification is suitable for use in a particular customer application.
2. We also point out that **in individual cases, a malfunction of electronic components or failure before the end of their usual service life cannot be completely ruled out in the current state of the art, even if they are operated as specified**. In customer applications requiring a very high level of operational safety and especially in customer applications in which the malfunction or failure of an electronic component could endanger human life or health (e.g. in accident prevention or life-saving systems), it must therefore be ensured by means of suitable design of the customer application or other action taken by the customer (e.g. installation of protective circuitry or redundancy) that no injury or damage is sustained by third parties in the event of malfunction or failure of an electronic component.
3. **The warnings, cautions and product-specific notes must be observed.**
4. In order to satisfy certain technical requirements, **some of the products described in this publication may contain substances subject to restrictions in certain jurisdictions (e.g. because they are classed as hazardous)**. Useful information on this will be found in our Material Data Sheets on the Internet ([www.tdk-electronics.tdk.com/material](http://www.tdk-electronics.tdk.com/material)). Should you have any more detailed questions, please contact our sales offices.
5. We constantly strive to improve our products. Consequently, **the products described in this publication may change from time to time**. The same is true of the corresponding product specifications. Please check therefore to what extent product descriptions and specifications contained in this publication are still applicable before or when you place an order.  
  
We also **reserve the right to discontinue production and delivery of products**. Consequently, we cannot guarantee that all products named in this publication will always be available. The aforementioned does not apply in the case of individual agreements deviating from the foregoing for customer-specific products.
6. Unless otherwise agreed in individual contracts, **all orders are subject to our General Terms and Conditions of Supply**.
7. **Our manufacturing sites serving the automotive business apply the IATF 16949 standard**. The IATF certifications confirm our compliance with requirements regarding the quality management system in the automotive industry. Referring to customer requirements and customer specific requirements ("CSR") TDK always has and will continue to have the policy of respecting individual agreements. Even if IATF 16949 may appear to support the acceptance of unilateral requirements, we hereby like to emphasize that **only requirements mutually agreed upon can and will be implemented in our Quality Management System**. For clarification purposes we like to point out that obligations from IATF 16949 shall only become legally binding if individually agreed upon.
8. The trade names EPCOS, CeraCharge, CeraDiode, CeraLink, CeraPad, CeraPlas, CSMP, CTVS, DeltaCap, DigiSiMic, ExoCore, FilterCap, FormFit, LeaXield, MiniBlue, MiniCell, MKD, MKK, MotorCap, PCC, PhaseCap, PhaseCube, PhaseMod, PhiCap, PowerHap, PQSine, PQvar, SIFERRIT, SIFI, SIKOREL, SilverCap, SIMDAD, SiMic, SIMID, SineFormer, SIOV, ThermoFuse, WindCap are **trademarks registered or pending** in Europe and in other countries. Further information will be found on the Internet at [www.tdk-electronics.tdk.com/trademarks](http://www.tdk-electronics.tdk.com/trademarks).

# Looking for pricing, stock, or lifecycle information?

Click below to explore more details on WIN SOURCE:

-  [View B43086A2106M on WIN SOURCE](#)
-  [EPCOS \(TDK\) Information](#)

## Optimize Your Supply Chain with WIN SOURCE Sol

-  Global Sourcing Solution
-  Obsolete Management
-  Cost Control Management
-  Shortage Management
-  Alternative Solution
-  Excess Inventory Management