



THE DATASHEET OF
191930364



DRWG. NO. CDK390

MATERIAL: COPPER
PLATING: TIN

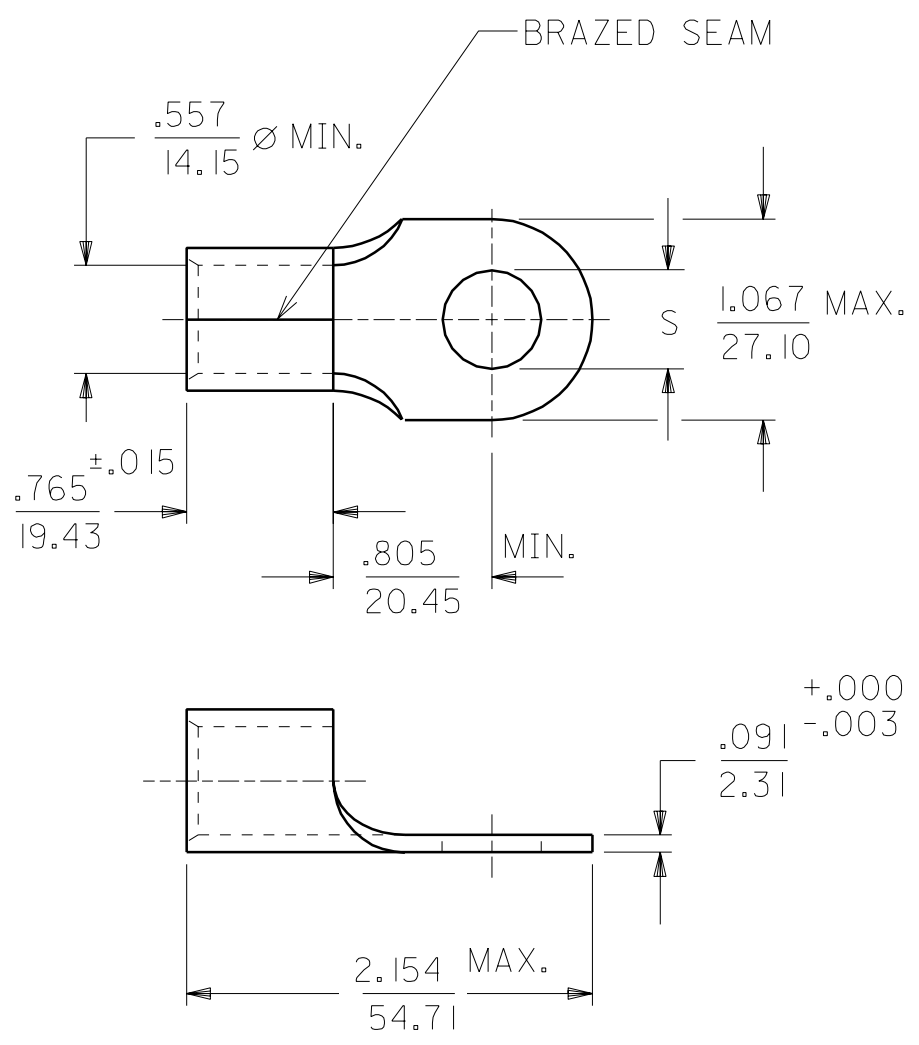

PART NO.	STUD SIZE	±.003 "S"
K-390-56	5/16	.328
K-390-38	3/8	.390
K-390-76	7/16	.453
K-390-12	1/2	.515
K-390-58	5/8	.656
K-390-34	3/4	.781

WIRE SIZE: 3/0 AWG
95 MM²

REVISE ONLY ON CAD SYSTEM

TITLE RING TONGUE TERMINAL
VERSAKRIMP
3/0 AWG

DRWG. BY EMF
CHK'D. BY JM
APP'D. BY FP
SCALE 1:1

molex ETC INC.
PINELLAS PARK, FLA. 34665 U.S.A.

PART NO. SEE CHART
FILE NAME CDK390

SHEET NO. DATE 12/01/93

DRWG. NO. CDK390

THIS DRAWING CONTAINS INFORMATION THAT IS PROPRIETARY TO MOLEX-ETC INC. AND SHOULD NOT BE USED WITHOUT WRITTEN PERMISSION.

DIV. SIZE A

Looking for pricing, stock, or lifecycle information?

Click below to explore more details on WIN SOURCE:

 [View 191930364 on WIN SOURCE](#)

 [Molex, LLC Information](#)

Optimize Your Supply Chain with WIN SOURCE Solutions

-  Global Sourcing Solution
-  Obsolete Management
-  Cost Control Management
-  Shortage Management
-  Alternative Solution
-  Excess Inventory Management