

Packaging Methods

- Standard Packing Quantity

Series	Size Code	Thickness (mm)	Kind of Taping	Pitch (mm)	Q'ty (pcs./reel)
EZJZ, EZJP	0 (0402)	0.5	Punched Carrier Taping	2	10,000
	1 (0603)	0.8		4	4,000

- Pitch 2mm (Punched Carrier Taping) : Size 0402

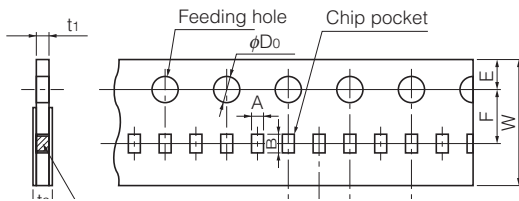

Symbol	A	B	W	F	E	P ₁	P ₂	P ₀	φD ₀	t ₁	t ₂
Dim (mm)	0.62 ±0.05	1.12 ±0.05	8.0 ±0.2	3.50 ±0.05	1.75 ±0.10	2.00 ±0.05	2.00 ±0.05	4.0 ±0.1	1.5 +0.1/0	0.7 max.	1.0 max.

- Pitch 4mm (Punched Carrier Taping) : Size 0603

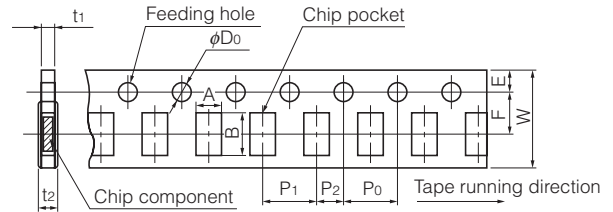

Symbol	A	B	W	F	E	P ₁	P ₂	P ₀	φD ₀	t ₁	t ₂
Dim (mm)	1.0 ±0.1	1.8 ±0.1	8.0 ±0.2	3.50 ±0.05	1.75 ±0.10	4.0 ±0.1	2.00 ±0.05	4.0 ±0.1	1.5 +0.1/0	1.1 max.	1.4 max.

- Reel for Taping

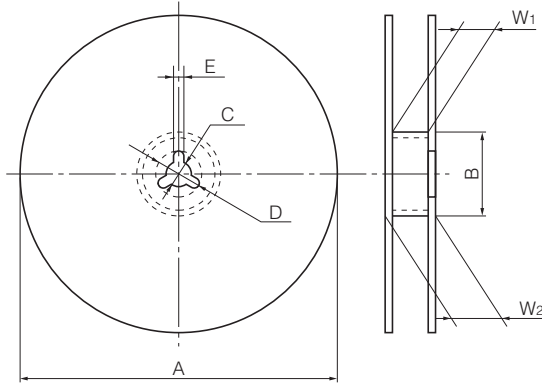

Symbol	A	B	C	D	E	W ₁	W ₂
Dima (mm)	φ180 ₋₃	φ60.0 ₀ ^{+1.0}	13.0±0.5	21.0±0.8	2.0±0.5	9.0 ₀ ^{+1.0}	11.4±1.0

- Leader Part and Taped End

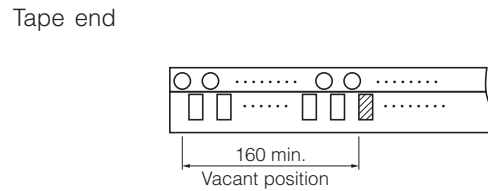
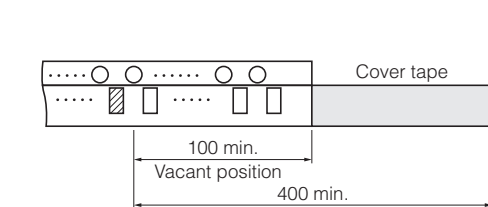

Dimensions in mm



Looking for pricing, stock, or lifecycle information?

Click below to explore more details on WIN SOURCE:

 [View EZJ-Z1V270GM](#) on WIN SOURCE

 [Panasonic](#) Information

Optimize Your Supply Chain with WIN SOURCE Solutions

-  Global Sourcing Solution
-  Obsolete Management
-  Cost Control Management
-  Shortage Management
-  Alternative Solution
-  Excess Inventory Management