



**THE DATASHEET OF  
1808HA330KAT1A**





# Surface Mount Ceramic Capacitor Products



# Ceramic Chip Capacitors



## Table of Contents

### How to Order

Part Number Explanation.....	2
------------------------------	---

### COG (NP0) Dielectric

General Specifications .....	4
Specifications and Test Methods.....	5
Capacitance Range .....	6

### U Dielectric

RF/Microwave COG (NP0) Capacitors (RoHS)	
General Information.....	8
Capacitance Range .....	9
RF/Microwave COG (NP0) Capacitors (Sn/Pb)	
General Information.....	11
Capacitance Range .....	12
RF/Microwave Automotive COG (NP0) Capacitors (RoHS)	
AEC Q200 Qualified Ultra Low ESR.....	13
Designer Kits.....	15

### X8R/X8L Dielectric

General Specifications .....	16
Specifications and Test Methods.....	18

### X7R Dielectric

General Specifications .....	19
Specifications and Test Methods.....	20
Capacitance Range .....	21

### X7S Dielectric

General Specifications .....	23
Specifications and Test Methods.....	24
Capacitance Range .....	25

### X5R Dielectric

General Specifications .....	26
Specifications and Test Methods.....	27
Capacitance Range .....	28

### Y5V Dielectric

General Specifications .....	30
Specifications and Test Methods.....	31
Capacitance Range .....	32

### MLCC Gold Termination – AU Series

General Specifications .....	33
Capacitance Range .....	34

### MLCC Tin/Lead Termination "B" (LD Series)

COG (NP0) – General Specifications .....	40
Specifications and Test Methods .....	41
Capacitance Range .....	42
X8R      General Specifications .....	44
Specifications and Test Methods .....	45
Capacitance Range .....	46
X7R      General Specifications .....	47
Specifications and Test Methods .....	48
Capacitance Range .....	49
X5R      General Specifications .....	51
Specifications and Test Methods .....	52
Capacitance Range .....	53

### Automotive MLCC

General Specifications .....	54
Capacitance Range .....	56

### APS for COTS+ High Reliability Applications

General Specifications .....	59
Capacitance Range .....	60

### MLCC with FLEXITERM®

General Specifications .....	63
Specifications and Test Methods.....	64
Capacitance Range .....	66

### FLEXISAFE MLC Chips

General Specifications and Capacitance Range .....	68
--	----

### Capacitor Array

Capacitor Array (IPC).....	69
Automotive Capacitor Array (IPC) .....	73
Part & Pad Layout Dimensions .....	74

### Low Inductance Capacitors

Introduction .....	75
LICC (Low Inductance Chip Capacitors) .....	77
IDC (InterDigitated Capacitors).....	81
LGA Low Inductance Capacitors.....	85

### High Temperature MLCCs

AT Series – 200°C & 250°C Rated .....	88
---------------------------------------	----

### High Voltage MLC Chips

For 600V to 5000V Applications .....	94
Tin/Lead Termination "B" - 600V to 5000V Applications.....	99
FLEXITERM® - 600V to 5000V Applications.....	101
For 600V to 3000V Automotive Applications - AEC-Q200.....	106

### MIL-PRF-55681/Chips

CDR01 thru CDR06.....	108
CDR31 thru CDR35.....	110

### MLCC Medical Applications

MM Series .....	114
-----------------	-----

### Packaging of Chip Components

Embossed Carrier Configuration .....	120
Paper Carrier Configuration .....	121

### Basic Capacitor Formulas

General Description.....	122
--------------------------	-----

### General Description

Surface Mounting Guide.....	128
-----------------------------	-----

# How to Order

## Part Number Explanation



### Commercial Surface Mount Chips

#### EXAMPLE: 08055A101JAT2A

0805	5	A	101	J*	A	T	2	A**
<b>Size</b> (L" x W")	<b>Voltage</b>	<b>Dielectric</b>	<b>Capacitance</b>	<b>Tolerance</b>	<b>Failure Rate</b>	<b>Terminations</b>	<b>Packaging Available</b>	<b>Special Code</b>
0101*	4 = 4V	A = NP0(C0G)	2 Sig. Fig + No. of Zeros	B = ±10 pF	A = N/A	T = Plated Ni and Sn	2 = 7" Reel	A = Std
0201	6 = 6.3V	C = X7R	Examples:	C = ±25 pF	4 = Automotive	7 = Gold Plated	4 = 13" Reel	K = 30K (0603 2mm pitch)
0402	Z = 10V	D = X5R	100 = 10 pF	D = ±50 pF		U = Conductive Epoxy for Hybrid	U = 4mm TR (01005)	22K (0805/1206 <0.030" / 0.76mm)
0603	Y = 16V	F = X8R	101 = 100 pF	F = ±1%		Z = FLEXITERM®		H = 18K (0603/0805/1206 <0.037" / 0.94mm)
0805	D = 35V	G = Y5V	102 = 1000 pF	G = ±2%		*X = FLEXITERM®	<b>Contact Factory For Multiples</b>	J = 15K (0805/1206 <0.050" / 1.27mm)
1206	5 = 50V	U = U Series	223 = 22000 pF	J = ±5%		with 5% min lead (X7R & X8R only)		1 = 12K (0805/1206 <0.055" / 1.4mm)
1210	W = X6S	Z = X7S	224 = 220000 pF	K = ±10%				**Non std options upon approval from the factory
1812	1 = 100V		105 = 1µF	M = ±20%				
1825	2 = 200V		106 = 10µF	Z = +80%, -20%				
2220	7 = 500V		107 = 100µF	P = +100%, -0%				
2225			For values below 10 pF, use "R" in place of Decimal point, e.g., 9.1 pF = 9R1.					
*EIA 01005	<b>Contact Factory for Special Voltages</b>					<b>Contact Factory For 1 = Pd/Ag Term</b>		
	F = 63V	9 = 300V						
	* = 75V	X = 350V						
	E = 150V	8 = 400V						
	V = 250V							

\* B, C & D tolerance for ≤10 pF values.

Standard Tape and Reel material (Paper/Embossed) depends upon chip size and thickness.

See individual part tables for tape material type for each capacitance value.

NOTE: Contact factory for availability of Termination and Tolerance Options for Specific Part Numbers.

For Tin/Lead Terminations, please refer to LD Series

### High Voltage MLC Chips

#### EXAMPLE: 1808AA271KA11A

1808	A	A	271	K	A	T	2	A
<b>AVX Style</b>	<b>Voltage</b>	<b>Temperature Coefficient</b>	<b>Capacitance Code</b>	<b>Capacitance Tolerance</b>	<b>Failure Rate</b>	<b>Termination</b>	<b>Packaging/ Marking</b>	<b>Special Code</b>
0805	C = 600V/630V	A = C0G	(2 significant digits + no. of zeros)	J = ±5%	A=Not Applicable	1 = Pd/Ag	2 = 7" Reel	A = Standard
1206	A = 1000V	C = X7R	Examples:	K = ±10%		T = Plated Ni and Sn	4 = 13" Reel	
1210	S = 1500V		10 pF = 100	M = ±20%		B = 5% Min Pb		
1808	G = 2000V		100 pF = 101	K = ±10%		Z = FLEXITERM®		
1812	W = 2500V		1,000 pF = 102	M = ±20%		*X = FLEXITERM®		
1825	H = 3000V		22,000 pF = 223	Z = +80%, -20%		with 5% min lead (X7R only)		
2220	J = 4000V		220,000 pF = 224					
2225	K = 5000V		1 µF = 105					
3640								

NOTE: Contact factory for availability of Termination and Tolerance Options for Specific Part Numbers.

For Tin/Lead Terminations, please refer to LD Series

**\* Not RoHS Compliant**



For RoHS compliant products,  
please select correct termination style.

# How to Order

## Part Number Explanation



### Capacitor Array

#### EXAMPLE: W2A43C103MAT2A

W	2	A	4	3	C	103	M	A	T	2A
<b>Style</b> W = RoHS L = SnPb	<b>Case Size</b> 1 = 0405 2 = 0508 3 = 0612	<b>Array</b>	<b>Number of Caps</b>	<b>Voltage</b> Z = 10V Y = 16V 3 = 25V 5 = 50V 1 = 100V	<b>Dielectric</b> A = NP0 C = X7R D = X5R	<b>Capacitance Code (In pF)</b> 2 Sig Digits + Number of Zeros	<b>Capacitance Tolerance</b> J = ±5% K = ±10% M = ±20%	<b>Failure Rate</b> A = Commercial 4 = Automotive	<b>Termination Code</b> T = Plated Ni and Sn Z = FLEXITERM® *B = 5% min lead *X = FLEXITERM® with 5% min lead	<b>Packaging &amp; Quantity Code</b> 2A = 7" Reel (4000) 4A = 13" Reel (10000) 2F = 7" Reel (1000)

NOTE: Contact factory for availability of Termination and Tolerance Options for Specific Part Numbers.

### Low Inductance Capacitors (LICC)

#### EXAMPLE: 0612ZD105MAT2A

0612	Z	D	105	M	A	T	2	A
<b>Size</b> 0306 0508 0612 *LD16 *LD17 *LD18	<b>Voltage</b> 6 = 6.3V Z = 10V Y = 16V 3 = 25V 5 = 50V	<b>Dielectric</b> C = X7R D = X5R	<b>Capacitance Code (In pF)</b> 2 Sig. Digits + Number of Zeros	<b>Capacitance Tolerance</b> K = ±10% M = ±20%	<b>Failure Rate</b> A = N/A	<b>Terminations</b> T = Plated Ni and Sn *B = 5% min lead	<b>Packaging Available</b> 2 = 7" Reel 4 = 13" Reel	<b>Thickness</b> See Page 97 for Codes

NOTE: Contact factory for availability of Termination and Tolerance Options for Specific Part Numbers.

### Interdigitated Capacitors (IDC)

#### EXAMPLE: W3L16D225MAT3A

W	3	L	1	6	D	225	M	A	T	3	A
<b>Style</b> W = RoHS L = SnPb	<b>Case Size</b> 2 = 0508 3 = 0612	<b>Low Inductance</b> ESL = 50pH ESL = 60pH	<b>Number of Terminals</b> 1 = 8 Terminals	<b>Voltage</b> 4 = 4V 6 = 6.3V Z = 10V Y = 16V	<b>Dielectric</b> C = X7R D = X5R	<b>Capacitance Code (In pF)</b> 2 Sig. Digits + Number of Zeros	<b>Capacitance Tolerance</b> M = ±20	<b>Failure Rate</b> A = N/A	<b>Termination</b> T = Plated Ni and Sn *B = 5% min lead	<b>Packaging Available</b> 1 = 7" Reel 3 = 13" Reel	<b>Thickness Max. Thickness</b> mm (in.) A = 0.95 (0.037) S = 0.55 (0.022)

NOTE: Contact factory for availability of Termination and Tolerance Options for Specific Part Numbers.

### Low Inductance Decoupling Capacitor Arrays (LICA)

#### EXAMPLE: LICA3T183M3FC4AA

LICA	3	T	102	M	3	F	C	4	A	A
<b>Style &amp; Size</b> 5V = 9 10V = Z 25V = 3	<b>Voltage</b>	<b>Dielectric</b> D = X5R T = T55T S = High K T55T	<b>Cap/Section (EIA Code)</b> 102 = 1000 pF 103 = 10 nF 104 = 100 nF	<b>Capacitance Tolerance</b> M = ±20% P = GMV	<b>Height Code</b> 6 = 0.500mm 3 = 0.650mm 1 = 0.875mm 5 = 1.100mm 7 = 1.600mm	<b>Termination</b> *F = C4 Solder Balls-97Pb/3Sn H = C4 Solder Balls-Low ESR P = Cr-Cu-Au N = Cr-Ni-Au X = None	<b>Reel Packaging</b> M = 7" Reel R = 13" Reel 6 = 2"x2" Waffle Pack 8 = 2"x2" Black Waffle Pack 7 = 2"x2" Waffle Pack w/termination facing up A = 2"x2" Black Waffle Pack w/termination facing up C = 4"x4" Waffle Pack w/ clearlid	<b># of Caps/Part</b> 1 = one 2 = two 4 = four	<b>Inspection Code</b> A = Standard Reliability Testing B = Established Reliability Testing	<b>Code Face</b> A = Bar B = No Bar C = Dot, S55S Dielectrics D = Triangle

**\* Not RoHS Compliant**



NOTE: Contact factory for availability of Termination and Tolerance Options for Specific Part Numbers.



# COG (NP0) Dielectric

## General Specifications



COG (NP0) is the most popular formulation of the “temperature-compensating,” EIA Class I ceramic materials. Modern COG (NP0) formulations contain neodymium, samarium and other rare earth oxides.

COG (NP0) ceramics offer one of the most stable capacitor dielectrics available. Capacitance change with temperature is  $0 \pm 30\text{ppm}/^\circ\text{C}$  which is less than  $\pm 0.3\%$  C from  $-55^\circ\text{C}$  to  $+125^\circ\text{C}$ . Capacitance drift or hysteresis for COG (NP0) ceramics is negligible at less than  $\pm 0.05\%$  versus up to  $\pm 2\%$  for films. Typical capacitance change with life is less than  $\pm 0.1\%$  for COG (NP0), one-fifth that shown by most other dielectrics. COG (NP0) formulations show no aging characteristics.



### PART NUMBER (see page 4 for complete part number explanation)

<b>0805</b>	<b>5</b>	<b>A</b>	<b>101</b>	<b>J</b>	<b>A</b>	<b>T</b>	<b>2</b>	<b>A</b>
<b>Size</b> (L" x W")	<b>Voltage</b> 6.3V = 6 10V = Z 16V = Y 25V = 3 50V = 5 100V = 1 200V = 2 500V = 7	<b>Dielectric</b> COG (NP0) = A	<b>Capacitance Code (In pF)</b> 2 Sig. Digits + Number of Zeros	<b>Capacitance Tolerance</b> C = $\pm 0.25$ pF ( $< 10$ pF) D = $\pm 0.50$ pF ( $< 10$ pF) F = $\pm 1\%$ ( $\geq 10$ pF) G = $\pm 2\%$ ( $\geq 10$ pF) J = $\pm 5\%$ K = $\pm 10\%$	<b>Failure Rate</b> A = Not Applicable	<b>Terminations</b> T = Plated Ni and Sn	<b>Packaging</b> 2 = 7" Reel 4 = 13" Reel U = 4mm TR (01005)	<b>Special Code</b> A = Std. Product
						<b>Contact Factory For</b> <b>1 = Pd/Ag Term</b> <b>7 = Gold Plated</b> <b>NOT RoHS COMPLIANT</b>	<b>Contact Factory For Multiples</b>	

NOTE: Contact factory for availability of Termination and Tolerance Options for Specific Part Numbers. Contact factory for non-specified capacitance values.

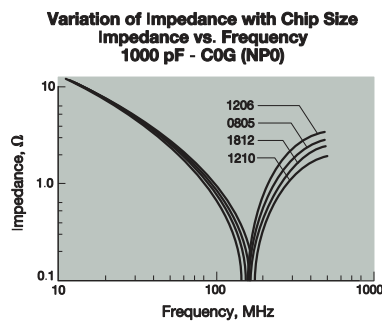
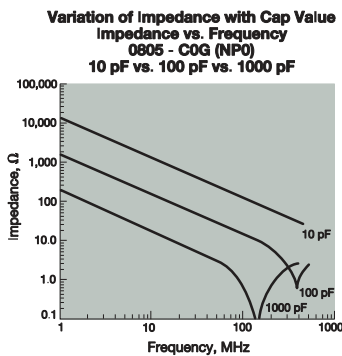
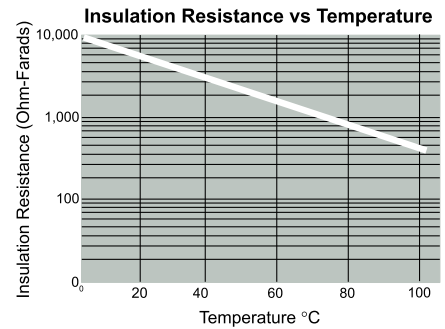
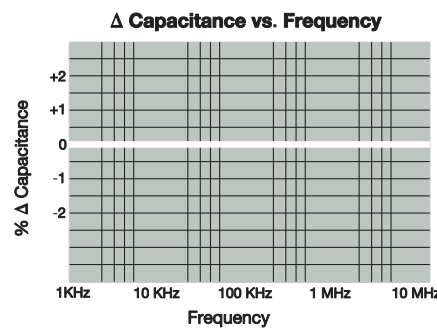
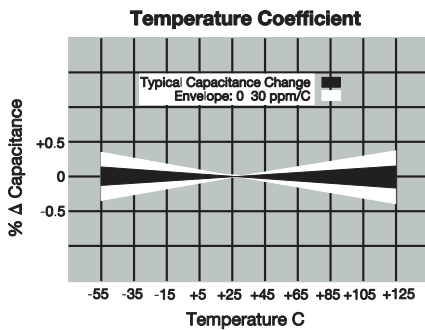

# COG (NP0) Dielectric

## Specifications and Test Methods



Parameter/Test		NPO Specification Limits	Measuring Conditions	
Operating Temperature Range		-55°C to +125°C	Temperature Cycle Chamber	
Capacitance		Within specified tolerance <30 pF: Q ≥ 400+20 x Cap Value ≥30 pF: Q ≥ 1000	Freq.: 1.0 MHz ± 10% for cap ≤ 1000 pF 1.0 kHz ± 10% for cap > 1000 pF Voltage: 1.0Vrms ± .2V	
Q				
Insulation Resistance		100,000MΩ or 1000MΩ - μF, whichever is less	Charge device with rated voltage for 60 ± 5 secs @ room temp/humidity	
Dielectric Strength		No breakdown or visual defects	Charge device with 250% of rated voltage for 1-5 seconds, w/charge and discharge current limited to 50 mA (max) Note: Charge device with 150% of rated voltage for 500V devices.	
Resistance to Flexure Stresses	Appearance	No defects		
	Capacitance Variation	±5% or ±.5 pF, whichever is greater		
	Q	Meets Initial Values (As Above)		
	Insulation Resistance	≥ Initial Value x 0.3		
Solderability		≥ 95% of each terminal should be covered with fresh solder	Dip device in eutectic solder at 230 ± 5°C for 5.0 ± 0.5 seconds	
Resistance to Solder Heat	Appearance	No defects, <25% leaching of either end terminal	Dip device in eutectic solder at 260°C for 60sec- onds. Store at room temperature for 24 ± 2hours before measuring electrical properties.	
	Capacitance Variation	≤ ±2.5% or ±.25 pF, whichever is greater		
	Q	Meets Initial Values (As Above)		
	Insulation Resistance	Meets Initial Values (As Above)		
	Dielectric Strength	Meets Initial Values (As Above)		
Thermal Shock	Appearance	No visual defects	Step 1: -55°C ± 2°	30 ± 3 minutes
	Capacitance Variation	≤ ±2.5% or ±.25 pF, whichever is greater	Step 2: Room Temp	≤ 3 minutes
	Q	Meets Initial Values (As Above)	Step 3: +125°C ± 2°	30 ± 3 minutes
	Insulation Resistance	Meets Initial Values (As Above)	Step 4: Room Temp	≤ 3 minutes
	Dielectric Strength	Meets Initial Values (As Above)	Repeat for 5 cycles and measure after 24 hours at room temperature	
Load Life	Appearance	No visual defects	Charge device with twice rated voltage in test chamber set at 125°C ± 2°C for 1000 hours (+48, -0).  Remove from test chamber and stabilize at room temperature for 24 hours before measuring.	
	Capacitance Variation	≤ ±3.0% or ±.3 pF, whichever is greater		
	Q (C=Nominal Cap)	≥ 30 pF: Q ≥ 350 ≥10 pF, <30 pF: Q ≥ 275 +5C/2 <10 pF: Q ≥ 200 +10C		
	Insulation Resistance	≥ Initial Value x 0.3 (See Above)		
Load Humidity	Appearance	No visual defects	Store in a test chamber set at 85°C ± 2°C/ 85% ± 5% relative humidity for 1000 hours (+48, -0) with rated voltage applied.  Remove from chamber and stabilize at room temperature for 24 ± 2 hours before measuring.	
	Capacitance Variation	≤ ±5.0% or ±.5 pF, whichever is greater		
	Q	≥ 30 pF: Q ≥ 350 ≥10 pF, <30 pF: Q ≥ 275 +5C/2 <10 pF: Q ≥ 200 +10C		
	Insulation Resistance	≥ Initial Value x 0.3 (See Above)		
	Dielectric Strength	Meets Initial Values (As Above)		

# COG (NP0) Dielectric

## Capacitance Range



PREFERRED SIZES ARE SHADED

SIZE	0101*			0201			0402			0603				0805					1206				
Soldering	Reflow Only			Reflow Only			Reflow/Wave			Reflow/Wave				Reflow/Wave					Reflow/Wave				
Packaging	All Paper			All Paper			All Paper			All Paper				Paper/Embossed					Paper/Embossed				
(L) Length	0.40 ± 0.02 (0.016 ± 0.0008)			0.60 ± 0.09 (0.024 ± 0.004)			1.00 ± 0.10 (0.040 ± 0.004)			1.60 ± 0.15 (0.063 ± 0.006)				2.01 ± 0.20 (0.079 ± 0.008)					3.20 ± 0.20 (0.126 ± 0.008)				
(W) Width	0.20 ± 0.02 (0.008 ± 0.0008)			0.30 ± 0.09 (0.011 ± 0.004)			0.50 ± 0.10 (0.020 ± 0.004)			0.81 ± 0.15 (0.032 ± 0.006)				1.25 ± 0.20 (0.049 ± 0.008)					1.60 ± 0.20 (0.063 ± 0.008)				
(t) Terminal	0.10 ± 0.04 (0.004 ± 0.0016)			0.15 ± 0.05 (0.006 ± 0.002)			0.25 ± 0.15 (0.010 ± 0.006)			0.35 ± 0.15 (0.014 ± 0.006)				0.50 ± 0.25 (0.020 ± 0.010)					0.50 ± 0.25 (0.020 ± 0.010)				
WVDC	16			25			50			16				25					50				
Cap (pF)	0.5			A			C			G				J					J				
	1.0			B			C			G				J					J				
	1.2			A			C			G				J					J				
	1.5			A			C			G				J					J				
	1.8			A			C			G				J					J				
	2.2			A			C			G				J					J				
	2.7			A			C			G				J					J				
	3.3			A			C			G				J					J				
	3.9			A			C			G				J					J				
	4.7			A			C			G				J					J				
	5.6			A			C			G				J					J				
	6.8			A			C			G				J					J				
	8.2			A			C			G				J					J				
	10			A			C			G				J					J				
	12			A			C			G				J					J				
	15			A			C			G				J					J				
	18			A			C			G				J					J				
	22			A			C			G				J					J				
	27			A			C			G				J					J				
	33			A			C			G				J					J				
	39			A			C			G				J					J				
	47			A			C			G				J					J				
	56			A			C			G				J					J				
	68			A			C			G				J					J				
	82			A			C			G				J					J				
	100			A			C			G				J					J				
	120			A			C			G				J					J				
	150			A			C			G				J					J				
	180			A			C			G				J					J				
	220			A			C			G				J					J				
	270			A			C			G				J					J				
	330			A			C			G				J					J				
	390			A			C			G				J					J				
	470			A			C			G				J					J				
	560			A			C			G				J					J				
	680			A			C			G				J					J				
	820			A			C			G				J					J				
	1000			A			C			G				J					J				
	1200			A			C			G				J					J				
	1500			A			C			G				J					J				
	1800			A			C			G				J					J				
	2200			A			C			G				J					J				
	2700			A			C			G				J					J				
	3300			A			C			G				J					J				
	3900			A			C			G				J					J				
	4700			A			C			G				J					J				
	5600			A			C			G				J					J				
	6800			A			C			G				J					J				
	8200			A			C			G				J					J				
Cap (µF)	0.010			A			C			G				J					J				
	0.012			A			C			G				J					J				
	0.015			A			C			G				J					J				
	0.018			A			C			G				J					J				
	0.022			A			C			G				J					J				
	0.027			A			C			G				J					J				
	0.033			A			C			G				J					J				
	0.039			A			C			G				J					J				
	0.047			A			C			G				J					J				
	0.068			A			C			G				J					J				
	0.082			A			C			G				J					J				
	0.1			A			C			G				J					J				
WVDC	16			25			50			16				25					50				



Letter	A	B	C	E	G		K	M	N	P	Q	X	Y	Z
Max. Thickness	0.33 (0.013)	0.22 (0.009)	0.56 (0.022)	0.71 (0.028)	0.90 (0.035)	0.94 (0.037)	1.02 (0.040)	1.27 (0.050)	1.40 (0.055)	1.52 (0.060)	1.78 (0.070)	2.29 (0.090)	2.54 (0.100)	2.79 (0.110)
	PAPER						EMBOSS							



# U Dielectric RF/Microwave COG (NP0) Capacitors (RoHS)



## Ultra Low ESR, "U" Series, COG (NP0) Chip Capacitors

### GENERAL INFORMATION

"U" Series capacitors are COG (NP0) chip capacitors specially designed for "Ultra" low ESR for applications in the communications market. Max ESR and effective capacitance are met on each value producing lot to lot uniformity. Sizes available are EIA chip sizes 0402, 0603, 0805, and 1210.

### DIMENSIONS: INCHES (MILLIMETERS)

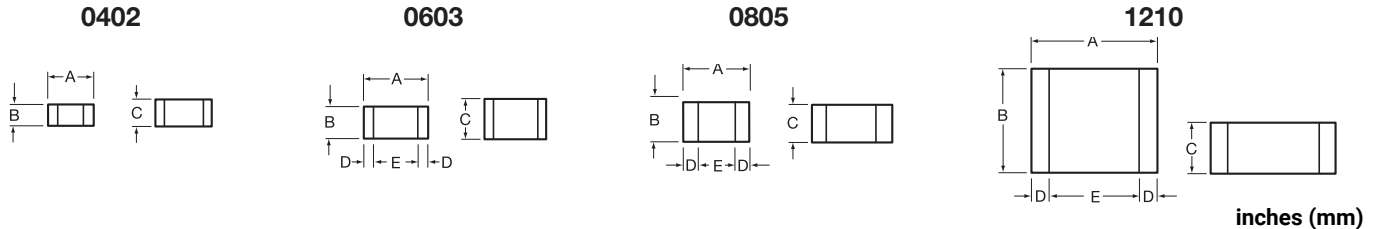

Size	A	B	C	D	E
0402	0.039±0.004 (1.00±0.1)	0.020±0.004 (0.50±0.1)	0.022 (0.55mm) max	N/A	N/A
0603	0.060±0.010 (1.52±0.25)	0.030±0.010 (0.76±0.25)	0.036 (0.91mm) max	0.010±0.005 (0.25±0.13)	0.030 (0.76) min
0805	0.079±0.008 (2.01±0.2)	0.049±0.008 (1.25±0.2)	0.040±0.005 (1.02±0.127)	0.020±0.010 (0.51±0.255)	0.020 (0.51) min
1210	0.126±0.008 (3.2±0.2)	0.098±0.008 (2.49±0.2)	0.050±0.005 (1.27±0.127)	0.025±0.015 (0.635±0.381)	0.040 (1.02) min

### HOW TO ORDER



NOTE: Contact factory for availability of Termination and Tolerance Options for Specific Part Numbers.

### ELECTRICAL CHARACTERISTICS

#### Capacitance Values and Tolerances:

- Size 0402 - 0.2 pF to 30 pF @ 1 MHz
- Size 0603 - 1.0 pF to 100 pF @ 1 MHz
- Size 0805 - 1.6 pF to 160 pF @ 1 MHz
- Size 1210 - 2.4 pF to 1000 pF @ 1 MHz

#### Temperature Coefficient of Capacitance (TC):

0±30 ppm/°C (-55° to +125°C)

#### Insulation Resistance (IR):

- 10<sup>12</sup> Ω min. @ 25°C and rated WVDC
- 10<sup>11</sup> Ω min. @ 125°C and rated WVDC

#### Working Voltage (WVDC):

- |      |                     |                      |
|------|---------------------|----------------------|
| Size | Working Voltage     | 0805 - 200, 100 WVDC |
| 0402 | - 100, 50, 25 WVDC  | 1210 - 200, 100 WVDC |
| 0603 | - 200, 100, 50 WVDC |                      |

#### Dielectric Working Voltage (DWV):

250% of rated WVDC

#### Equivalent Series Resistance Typical (ESR):

- 0402 - See Performance Curve, page 13
- 0603 - See Performance Curve, page 13
- 0805 - See Performance Curve, page 13
- 1210 - See Performance Curve, page 13

#### Marking:

Laser marking EIA J marking standard (except 0603) (capacitance code and tolerance upon request).

#### Military Specifications

Meets or exceeds the requirements of MIL-C-55681

# U Dielectric RF/Microwave COG (NP0) Capacitors (RoHS)



## Ultra Low ESR, "U" Series, COG (NP0) Chip Capacitors

### CAPACITANCE RANGE

Cap (pF)	Available Tolerance	Size			
		0402	0603	0805	1210
0.2	B,C	100V	N/A	N/A	N/A
0.3	↓ B,C	↓	↓	↓	↓
0.4					
0.5	B,C	↓	↓	↓	↓
0.6	B,C,D	↓	↓	↓	↓
0.7	↓ B,C,D	↓	↓	↓	↓
0.8					
0.9	B,C,D	↓	↓	↓	↓

Cap (pF)	Available Tolerance	Size								
		0402	0603	0805	1210					
1.0	B,C,D	100V	200V	200V	200V					
1.1	↓ B,C,D	↓	↓	↓	↓					
1.2										
1.3										
1.4										
1.5										
1.6										
1.7										
1.8										
1.9										
2.0										
2.1										
2.2										
2.4										
2.7										
3.0	↓ B,C,D	↓	↓	↓	↓					
3.3										
3.6										
3.9										
4.3										
4.7										
5.1										
5.6										
6.2										
6.8										
7.5						B,C,J,K,M	100V	200V	200V	200V
8.2						↓ B,C,J,K,M	↓	↓	↓	↓
9.1										
10										
11										
12										
13										
15										
18										
20										
22										
24										
27										
30										
33										
36										
39										
43										
47										
51										
56										
68										
75										
82										
91										

Cap (pF)	Available Tolerance	Size			
		0402	0603	0805	1210
7.5	B,C,J,K,M	100V	200V	200V	200V
8.2	↓ B,C,J,K,M	↓	↓	↓	↓
9.1					
10					
11					
12					
13					
15					
18					
20					
22					
24					
27					
30					
33					
36					
39					
43					
47					
51					
56					
68					
75					
82					
91					

Cap (pF)	Available Tolerance	Size			
		0402	0603	0805	1210
100	F,G,J,K,M	N/A	100V	200V	200V
110	↓ F,G,J,K,M	↓	↓	↓	↓
120					
130					
140					
150					
160					
180					
200					
220					
270					
300					
330					
360					
390					
430					
470					
510					
560					
620					
680					
750					
820					
910					
1000					



### ULTRA LOW ESR, "U" SERIES

TYPICAL ESR vs. FREQUENCY  
0402 "U" SERIES



TYPICAL ESR vs. FREQUENCY  
0603 "U" SERIES



TYPICAL ESR vs. FREQUENCY  
0805 "U" SERIES



TYPICAL ESR vs. FREQUENCY  
1210 "U" SERIES



ESR Measured on the Boonton 34A

# U Dielectric

## RF/Microwave C0G (NP0) Capacitors

Ultra Low ESR, "U" Series, C0G (NP0) Chip Capacitors



TYPICAL  
SERIES RESONANT FREQUENCY  
"U" SERIES CHIP



# U Dielectric RF/Microwave COG (NP0) Capacitors (Sn/Pb)



## Ultra Low ESR, "U" Series, COG (NP0) Chip Capacitors

### GENERAL INFORMATION

"U" Series capacitors are COG (NP0) chip capacitors specially designed for "Ultra" low ESR for applications in the communications market. Max ESR and effective capacitance are met on each value producing lot to lot uniformity. Sizes available are EIA chip sizes 0402, 0603, 0805, and 1210.

### DIMENSIONS: INCHES (MILLIMETERS)

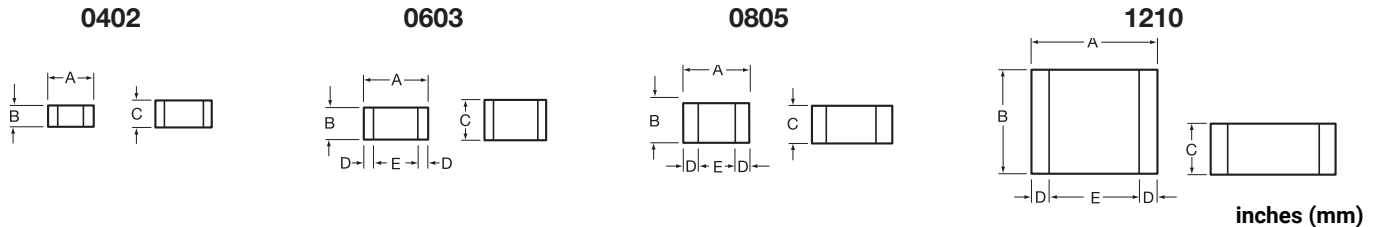

Size	A	B	C	D	E
0402	0.039±0.004 (1.00±0.1)	0.020±0.004 (0.50±0.1)	0.022 (0.55mm) max	N/A	N/A
0603	0.060±0.010 (1.52±0.25)	0.030±0.010 (0.76±0.25)	0.036 (0.91mm) max	0.010±0.005 (0.25±0.13)	0.030 (0.76) min
0805	0.079±0.008 (2.01±0.2)	0.049±0.008 (1.25±0.2)	0.040±0.005 (1.02±0.127)	0.020±0.010 (0.51±0.254)	0.020 (0.51) min
1210	0.126±0.008 (3.2±0.2)	0.098±0.008 (2.49±0.2)	0.050±0.005 (1.27±0.127)	0.025±0.015 (0.635±0.381)	0.040 (1.02) min

### HOW TO ORDER

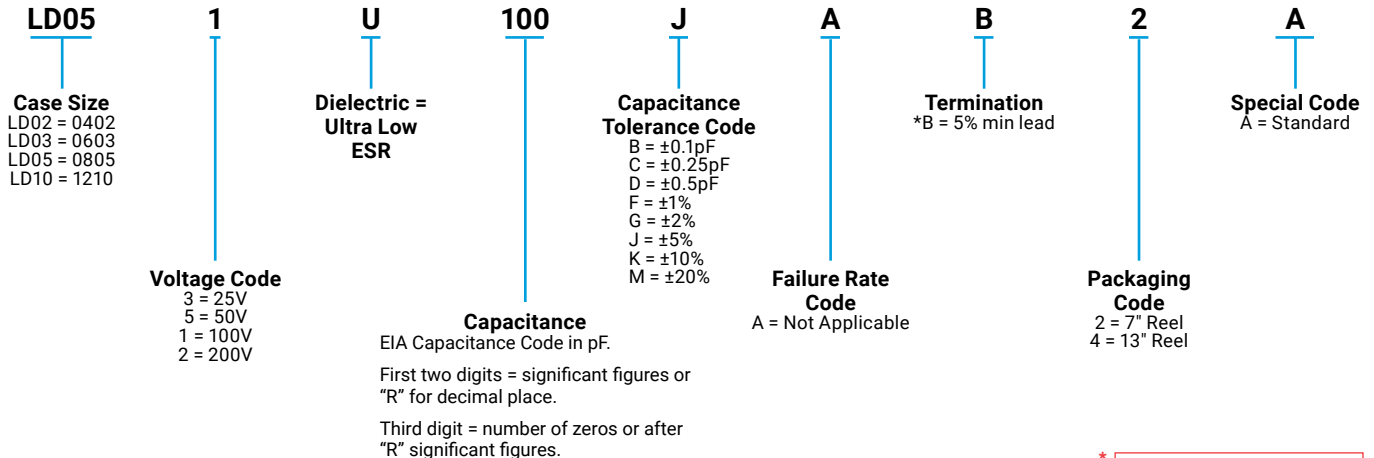

\* Not RoHS Compliant

### ELECTRICAL CHARACTERISTICS

#### Capacitance Values and Tolerances:

- Size 0402 - 0.2 pF to 22 pF @ 1 MHz
- Size 0603 - 1.0 pF to 100 pF @ 1 MHz
- Size 0805 - 1.6 pF to 160 pF @ 1 MHz
- Size 1210 - 2.4 pF to 1000 pF @ 1 MHz

#### Temperature Coefficient of Capacitance (TC):

0±30 ppm/°C (-55° to +125°C)

#### Insulation Resistance (IR):

- 10<sup>12</sup> Ω min. @ 25°C and rated WVDC
- 10<sup>11</sup> Ω min. @ 125°C and rated WVDC

#### Working Voltage (WVDC):

Size	Working Voltage
0402	50, 25 WVDC
0603	200, 100, 50 WVDC
0805	200, 100 WVDC
1210	200, 100 WVDC

#### Dielectric Working Voltage (DWV):

250% of rated WVDC

#### Equivalent Series Resistance Typical (ESR):

- 0402 - See Performance Curve, page 16
- 0603 - See Performance Curve, page 16
- 0805 - See Performance Curve, page 16
- 1210 - See Performance Curve, page 16

#### Marking:

Laser marking EIA J marking standard (except 0603) (capacitance code and tolerance upon request).

#### Military Specifications

Meets or exceeds the requirements of MIL-C-55681



# U Dielectric RF/Microwave C0G (NP0) Capacitors (Sn/Pb)



## Ultra Low ESR, "U" Series, C0G (NP0) Chip Capacitors

### CAPACITANCE RANGE

Cap (pF)	Available Tolerance	Size			
		LD02	LD03	LD05	LD10
0.2	B,C	50V	N/A	N/A	N/A
0.3	↓	↓	↓	↓	↓
0.4	B,C	↓	↓	↓	↓
0.5	B,C,D	↓	↓	↓	↓
0.6	B,C,D	↓	↓	↓	↓
0.7	↓	↓	↓	↓	↓
0.8	B,C,D	↓	↓	↓	↓
0.9	↓	↓	↓	↓	↓

Cap (pF)	Available Tolerance	Size			
		LD02	LD03	LD05	LD10
1.0	B,C,D	50V	200V	200V	200V
1.1	↓	↓	↓	↓	↓
1.2	↓	↓	↓	↓	↓
1.3	↓	↓	↓	↓	↓
1.4	↓	↓	↓	↓	↓
1.5	↓	↓	↓	↓	↓
1.6	↓	↓	↓	↓	↓
1.7	↓	↓	↓	↓	↓
1.8	↓	↓	↓	↓	↓
1.9	↓	↓	↓	↓	↓
2.0	↓	↓	↓	↓	↓
2.1	↓	↓	↓	↓	↓
2.2	↓	↓	↓	↓	↓
2.4	↓	↓	↓	↓	↓
2.7	↓	↓	↓	↓	↓
3.0	↓	↓	↓	↓	↓
3.3	↓	↓	↓	↓	↓
3.6	↓	↓	↓	↓	↓
3.9	↓	↓	↓	↓	↓
4.3	↓	↓	↓	↓	↓
4.7	↓	↓	↓	↓	↓
5.1	↓	↓	↓	↓	↓
5.6	↓	↓	↓	↓	↓
6.2	B,C,D	↓	↓	↓	↓
6.8	B,C,J,K,M	↓	↓	↓	↓

Cap (pF)	Available Tolerance	Size			
		LD02	LD03	LD05	LD10
7.5	B,C,J,K,M	50V	200V	200V	200V
8.2	↓	↓	↓	↓	↓
9.1	B,C,J,K,M	↓	↓	↓	↓
10	FG,J,K,M	↓	↓	↓	↓
11	↓	↓	↓	↓	↓
12	↓	↓	↓	↓	↓
13	↓	↓	↓	↓	↓
15	↓	↓	↓	↓	↓
18	↓	↓	↓	↓	↓
20	↓	↓	↓	↓	↓
22	↓	↓	↓	↓	↓
24	↓	↓	↓	↓	↓
27	↓	↓	↓	↓	↓
30	↓	↓	↓	↓	↓
33	↓	↓	↓	↓	↓
36	↓	↓	↓	↓	↓
39	↓	↓	↓	↓	↓
43	↓	↓	↓	↓	↓
47	↓	↓	↓	↓	↓
51	↓	↓	↓	↓	↓
56	↓	↓	↓	↓	↓
68	↓	↓	↓	↓	↓
75	↓	↓	↓	↓	↓
82	↓	↓	↓	↓	↓
91	↓	↓	↓	↓	↓

Cap (pF)	Available Tolerance	Size			
		LD02	LD03	LD05	LD10
100	FG,J,K,M	N/A	100V	200V	200V
110	↓	↓	↓	↓	↓
120	↓	↓	↓	↓	↓
130	↓	↓	↓	↓	↓
140	↓	↓	↓	↓	↓
150	↓	↓	↓	↓	↓
160	↓	↓	↓	↓	↓
180	↓	↓	↓	↓	↓
200	↓	↓	↓	↓	↓
220	↓	↓	↓	↓	↓
270	↓	↓	↓	↓	↓
300	↓	↓	↓	↓	↓
330	↓	↓	↓	↓	↓
360	↓	↓	↓	↓	↓
390	↓	↓	↓	↓	↓
430	↓	↓	↓	↓	↓
470	↓	↓	↓	↓	↓
510	↓	↓	↓	↓	↓
560	↓	↓	↓	↓	↓
620	↓	↓	↓	↓	↓
680	↓	↓	↓	↓	↓
750	↓	↓	↓	↓	↓
820	↓	↓	↓	↓	↓
910	↓	↓	↓	↓	↓
1000	FG,J,K,M	↓	↓	↓	↓



### ULTRA LOW ESR, "U" SERIES

TYPICAL ESR vs. FREQUENCY  
0402 "U" SERIES

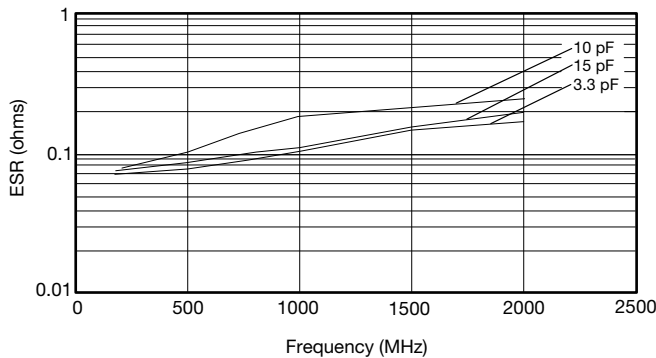

TYPICAL ESR vs. FREQUENCY  
0603 "U" SERIES



TYPICAL ESR vs. FREQUENCY  
0805 "U" SERIES

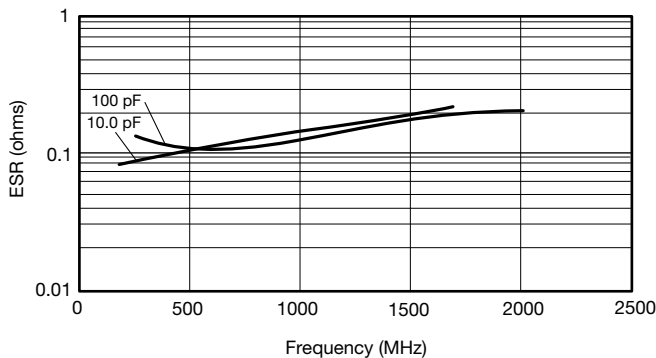

TYPICAL ESR vs. FREQUENCY  
1210 "U" SERIES



ESR Measured on the Boonton 34A



# U Dielectric

## RF/Microwave Automotive C0G (NP0) Capacitors (RoHS)

### AEC Q200 Qualified Ultra Low ESR, "U" Series, C0G (NP0) Chip Capacitors



#### GENERAL INFORMATION

Automotive "U" Series capacitors are C0G (NP0) chip capacitors specially designed for "Ultra" low ESR for applications in the automotive market. Max ESR and effective capacitance are met on each value producing lot to lot uniformity. Sizes available are EIA chip sizes 0402 and 0603.

#### DIMENSIONS: INCHES (MILLIMETERS)



Size	A	B	C	D	E
0402	1.00±0.1 (0.039±0.004)	0.50±0.1 (0.020±0.004)	0.60 max (0.024)	N/A	N/A
0603	1.52±0.25 (0.060±0.010)	0.76±0.25 (0.030±0.010)	0.91 max (0.036)	0.25±0.13 (0.010±0.005)	0.76 min (0.030)

#### HOW TO ORDER



#### ELECTRICAL CHARACTERISTICS

##### Capacitance Values and Tolerances:

Size 0402 - 0.2 pF to 22 pF @ 1 MHz  
 Size 0603 - 1.0 pF to 100 pF @ 1 MHz

##### Temperature Coefficient of Capacitance (TC):

0±30 ppm/°C (-55° to +125°C)

##### Insulation Resistance (IR):

10<sup>12</sup> Ω min. @ 25°C and rated WVDC  
 10<sup>11</sup> Ω min. @ 125°C and rated WVDC

##### Working Voltage (WVDC):

Size Working Voltage  
 0402 - 50, 25 WVDC  
 0603 - 200, 100, 50 WVDC

##### Dielectric Working Voltage (DWV):

250% of rated WVDC

##### Equivalent Series Resistance Typical (ESR):

0402 - See Performance Curve  
 0603 - See Performance Curve

##### Automotive Specifications

Meets or exceeds the requirements of AEC Q200

# U Dielectric

## RF/Microwave Automotive C0G (NP0) Capacitors (RoHS)

AEC Q200 Qualified, Ultra Low ESR, "U" Series, C0G (NP0) Chip Capacitors



### CAPACITANCE RANGE

Cap (pF)	Available Tolerance	Size	
		0402	0603
0.2	B,C	100V	N/A
0.3	↓	↓	↓
0.4	B,C	↓	↓
0.5	B,C,D	↓	↓
0.6	B,C,D	↓	↓
0.7	↓	↓	↓
0.8	↓	↓	↓
0.9	B,C,D	↓	↓

Cap (pF)	Available Tolerance	Size	
		0402	0603
1.0	B,C,D	100V	200V
1.1	↓	↓	↓
1.2	↓	↓	↓
1.3	↓	↓	↓
1.4	↓	↓	↓
1.5	↓	↓	↓
1.6	↓	↓	↓
1.7	↓	↓	↓
1.8	↓	↓	↓
1.9	↓	↓	↓
2.0	↓	↓	↓
2.1	↓	↓	↓
2.2	↓	↓	↓
2.4	↓	↓	↓
2.7	↓	↓	↓
3.0	↓	↓	↓
3.3	↓	↓	↓
3.6	↓	↓	↓
3.9	↓	↓	↓
4.3	↓	↓	↓
4.7	↓	↓	↓
5.1	↓	↓	↓
5.6	↓	↓	↓
6.2	B,C,D	↓	↓
6.8	B,C,J,K,M	↓	↓

Cap (pF)	Available Tolerance	Size	
		0402	0603
7.5	B,C,J,K,M	100V	200V
8.2	↓	↓	↓
9.1	B,C,J,K,M	↓	↓
10	F,G,J,K,M	↓	↓
11	↓	↓	↓
12	↓	↓	↓
13	↓	↓	↓
15	↓	↓	↓
18	↓	↓	200V
20	↓	↓	100V
22	↓	↓	↓
24	↓	↓	↓
27	↓	↓	↓
30	↓	↓	↓
33	↓	50V	↓
36	↓	N/A	↓
39	↓	↓	↓
43	↓	↓	↓
47	↓	↓	↓
51	↓	↓	↓
56	↓	↓	↓
68	↓	↓	↓
75	↓	↓	↓
82	↓	↓	↓
91	↓	↓	↓

Cap (pF)	Available Tolerance	Size	
		0402	0603
100	F,G,J,K,M	N/A	100V
110	↓	↓	50V
120	↓	↓	50V
130	↓	↓	N/A
140	↓	↓	↓
150	↓	↓	↓
160	↓	↓	↓
180	↓	↓	↓
200	↓	↓	↓
220	↓	↓	↓
270	↓	↓	↓
300	↓	↓	↓
330	↓	↓	↓
360	↓	↓	↓
390	↓	↓	↓
430	↓	↓	↓
470	↓	↓	↓
510	↓	↓	↓
560	↓	↓	↓
620	↓	↓	↓
680	↓	↓	↓
750	↓	↓	↓
820	↓	↓	↓
910	↓	↓	↓
1000	F,G,J,K,M	↓	↓

### ULTRA LOW ESR, "U" SERIES

TYPICAL ESR vs. FREQUENCY  
0402 "U" SERIES

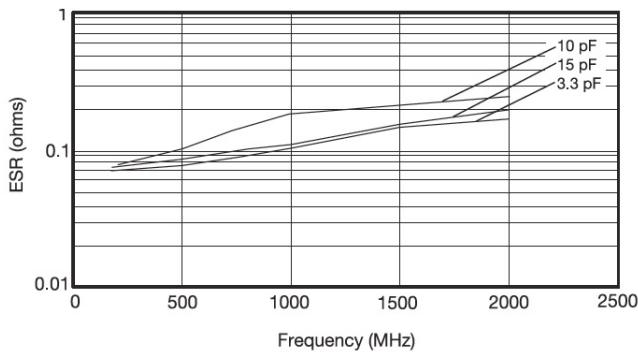

TYPICAL ESR vs. FREQUENCY  
0603 "U" SERIES

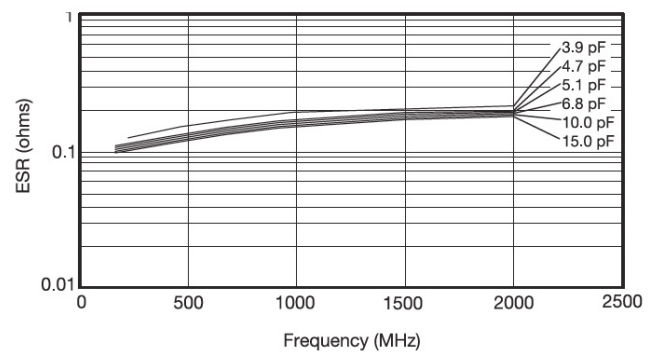

TYPICAL SERIES RESONANT FREQUENCY  
"U" SERIES CHIP



**"U" SERIES KITS**

**0402**

Kit 5000 UZ			
Cap. Value pF	Tolerance	Cap. Value pF	Tolerance
0.5	B ( $\pm 0.1\text{pF}$ )	4.7	B ( $\pm 0.1\text{pF}$ )
1.0		5.6	
1.5		6.8	
1.8		8.2	
2.2		10.0	
2.4	(±5%)	12.0	(±5%)
3.0		15.0	
3.6			

\*\*\*25 each of 15 values

**0603**

Kit 4000 UZ					
Cap. Value pF	Tolerance	Cap. Value pF	Tolerance		
1.0	B ( $\pm 0.1\text{pF}$ )	6.8	B ( $\pm 0.1\text{pF}$ )		
1.2		7.5			
1.5		8.2			
1.8		10.0			
2.0		12.0			
2.4		15.0			
2.7		18.0			
3.0		J ( $\pm 5\%$ )		22.0	J ( $\pm 5\%$ )
3.3				27.0	
3.9				33.0	
4.7				39.0	
5.6				47.0	

\*\*\*25 each of 24 values

**0805**

Kit 3000 UZ					
Cap. Value pF	Tolerance	Cap. Value pF	Tolerance		
1.0	B ( $\pm 0.1\text{pF}$ )	15.0	J ( $\pm 5\%$ )		
1.5		18.0			
2.2		22.0			
2.4		24.0			
2.7		27.0			
3.0		33.0			
3.3		36.0			
3.9		39.0			
4.7		47.0			
5.6		56.0			
7.5		68.0			
8.2		82.0			
9.1		100.0			
10.0		J ( $\pm 5\%$ )		130.0	J ( $\pm 5\%$ )
12.0				160.0	

\*\*\*25 each of 30 values

**1210**

Kit 3500 UZ			
Cap. Value pF	Tolerance	Cap. Value pF	Tolerance
2.2	B ( $\pm 0.1\text{pF}$ )	36.0	J ( $\pm 5\%$ )
2.7		39.0	
4.7		47.0	
5.1		51.0	
6.8		56.0	
8.2		68.0	
9.1		82.0	
10.0		100.0	
13.0		120.0	
15.0		130.0	
18.0	J ( $\pm 5\%$ )	240.0	J ( $\pm 5\%$ )
20.0		300.0	
24.0		390.0	
27.0		470.0	
30.0		680.0	

\*\*\*25 each of 30 values

# X8R/X8L Dielectric

## General Specifications

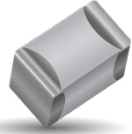

AVX has developed a range of multilayer ceramic capacitors designed for use in applications up to 150°C. These capacitors are manufactured with an X8R and an X8L dielectric material. X8R material has capacitance variation of ± 15% between -55°C and +150°C. The X8L material has capacitance variation of ±15% between -55°C to 125°C to 125°C and +15/40% from +125°C to +150°C.

The need for X8R and X8L performance has been driven by customer requirements for parts that operate at elevated temperatures. They provide a highly reliable capacitor with low loss and stable capacitance over temperature.

They are ideal for automotive under the hood sensors, and various industrial applications. Typical industrial application would be drilling monitoring system. They can also be used as bulk capacitors for high temperature camera modules.

Both X8R and X8L dielectric capacitors are automotive AEC-Q200 qualified. Optional termination systems, tin, FLEXITERM® and conductive epoxy for hybrid applications are available. Providing this series with our FLEXITERM® termination system provides further advantage to customers by way of enhanced resistance to both, temperature cycling and mechanical damage.

<b>0805</b>	<b>5</b>	<b>A</b>	<b>104</b>	<b>K</b>	<b>4</b>	<b>T</b>	<b>2</b>	<b>A</b>
<b>Size</b>	<b>Voltage</b>	<b>Dielectric</b>	<b>Capacitance Code (in pF)</b>	<b>Capacitance Tolerance</b>	<b>Failure Rate</b>	<b>Terminations</b>	<b>Packaging</b>	<b>Special Code</b>
0402 0603 0805 1206	10V = Z 16V = Y 25V = 3 50V = 5 100V = 1	X8R = F X8L = L	2 Sig. Digits + Number of Zeros e.g. 10 F = 106	J = ±5% K = ±10% M = ±20%	4=Automotive A = Not Applicable	T = Plated Ni and Sn Z = FLEXITERM®**	2 = 7" Reel 4 = 13" Reel	A = Std. Product

NOTE: Contact factory for availability of Termination and Tolerance Options for Specific Part Numbers.

### X8R

Size	0603		0805		1206		
	Reflow/Wave		Reflow/Wave		Reflow/Wave		
Soldering	25V	50V	25V	50V	25V	50V	
271 Cap	270	G	G				
331 (pF)	330	G	G	J	J		
471	470	G	G	J	J		
681	680	G	G	J	J		
102	1000	G	G	J	J	J	
152	1500	G	G	J	J	J	
222	2200	G	G	J	J	J	
332	3300	G	G	J	J	J	
472	4700	G	G	J	J	J	
682	6800	G	G	J	J	J	
103 Cap	0.01	G	G	J	J	J	
153 (µF)	0.015	G	G	J	J	J	
223	0.022	G	G	J	J	J	
333	0.033	G	G	J	J	J	
473	0.047	G	G	J	J	J	
683	0.068	G		N	N	M	
104	0.1			N	N	M	
154	0.15			N	N	M	
224	0.22			N		M	
334	0.33					M	
474	0.47					M	
684	0.68						
105	1						
155	1.5						
225	2.2						
SIZE	WVDC	25V	50V	25V	50V	25V	50V

Size	0603	0805	1206	1210	
Soldering	Reflow/Wave	Reflow/Wave	Reflow/Wave	Reflow/Wave	
Packaging	All Paper	Paper/Embossed	Paper/Embossed	Paper/Embossed	
(L) Length	mm (in)	1.60 ± 0.15 (0.063 ± 0.006)	2.01 ± 0.20 (0.079 ± 0.008)	3.20 ± 0.20 (0.126 ± 0.008)	3.30 ± 0.4 (0.130 ± 0.016)
(W) Width	mm (in)	0.81 ± 0.15 (0.032 ± 0.006)	1.25 ± 0.20 (0.049 ± 0.008)	1.60 ± 0.20 (0.063 ± 0.008)	2.50 ± 0.20 (0.098 ± 0.008)
(t) Terminal	mm (in)	0.35 ± 0.15 (0.014 ± 0.006)	0.50 ± 0.25 (0.020 ± 0.010)	0.50 ± 0.25 (0.020 ± 0.010)	0.50 ± 0.25 (0.020 ± 0.010)

### X8L

Size	0603			0805			1206				1210			
	Reflow/Wave			Reflow/Wave			Reflow/Wave				Reflow/Wave			
Soldering	25V	50V	100V	25V	50V	100V	16V	25V	50V	100V	10V	50V	100V	
271 Cap	270	G	G											
331 (pF)	330	G	G	G	J	J	J							
471	470	G	G	G	J	J	J							
681	680	G	G	G	J	J	J							
102	1000	G	G	G	J	J	J	J	J					
152	1500	G	G	G	J	J	J	J	J	J				
182	1800	G	G	G	J	J	J	J	J	J				
222	2200	G	G	G	J	J	J	J	J	J				
272	2700	G	G	G	J	J	J	J	J	J				
332	3300	G	G	G	J	J	J	J	J	J				
392	3900	G	G	G	J	J	J	J	J	J				
472	4700	G	G	G	J	J	J	J	J	J				
562	5600	G	G	G	J	J	J	J	J	J				
682	6800	G	G	G	J	J	J	J	J	J				
822	8200	G	G	G	J	J	J	J	J	J				
103 Cap	0.01	G	G	G	J	J	J	J	J	J				
123 (µF)	0.012	G	G		J	J	J	J	J	J				
153	0.015	G	G		J	J	J	J	J	J				
183	0.018	G	G		J	J	J	J	J	J				
223	0.022	G	G		J	J	J	J	J	J				
273	0.027	G	G		J	J	J	J	J	J				
333	0.033	G	G		J	J	N	J	J	J				
393	0.039	G	G		J	J	N	J	J	J				
473	0.047	G	G		J	J	N	J	J	J				
563	0.056	G	G		J	J	N	J	J	J				
683	0.068	G	G		J	J	N	J	J	J				
823	0.082	G	G		J	J	N	J	J	J				
104	0.1	G	G		J	J	N	J	J	J	M			
124	0.12				J	N		J	J	M				
154	0.15				J	N		J	J	J	Q			
184	0.18				N	N		J	J	J	Q			
224	0.22				N	N		J	J	J	Q			
274	0.27				N			J	M	M	Q			
334	0.33				N			J	M	M	Q			
394	0.39				N			M	M	P	Q			
474	0.47				N			M	M	P	Q			
684	0.68				N			M	M	P	Q			
824	0.82				N			M	M	P	Q			
105	1				N			M	M	P	Q			
155	1.5							M	M					
225	2.2							M	M			Z	Z	
475												Z		
106												Z		
SIZE	WVDC	25V	50V	100V	25V	50V	100V	16V	25V	50V	100V	10V	50V	100V

Letter	A	C	E	G	J	K	M	N	P	Q	X	Y	Z
Max. Thickness	0.33 (-0.013)	0.56 (-0.022)	0.71 (-0.028)	0.9 (-0.035)	0.94 (-0.037)	1.02 (-0.04)	1.27 (-0.05)	1.4 (-0.055)	1.52 (-0.06)	1.78 (-0.07)	2.29 (-0.09)	2.54 (-0.1)	2.79 (-0.11)
	PAPER					EMBOSSED							

■ = AEC-Q200 Qualified

# X8R/X8L Dielectric

## General Specifications



### APPLICATIONS FOR X8R AND X8L CAPACITORS

- All market sectors with a 150°C requirement
- Automotive on engine applications
- Oil exploration applications
- Hybrid automotive applications
  - Battery control
  - Inverter / converter circuits
  - Motor control applications
  - Water pump
- Hybrid commercial applications
  - Emergency circuits
  - Sensors
  - Temperature regulation

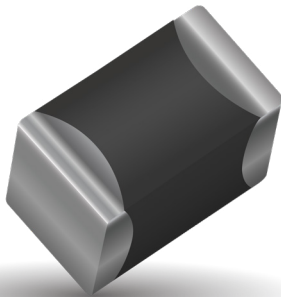

### ADVANTAGES OF X8R AND X8L MLC CAPACITORS

- Both ranges are qualified to the highest automotive AEC-Q200 standards
- Excellent reliability compared to other capacitor technologies
- RoHS compliant
- Low ESR / ESL compared to other technologies
- Tin solder finish
- FLEXITERM® available
- Epoxy termination for hybrid available
- 100V range available

### ENGINEERING TOOLS FOR HIGH VOLTAGE MLC CAPACITORS

- Samples
- Technical Articles
- Application Engineering
- Application Support



# X8R/X8L Dielectric

## Specifications and Test Methods

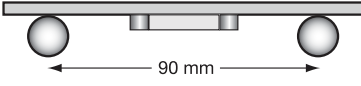

Parameter/Test		X8R/X8L Specification Limits	Measuring Conditions	
Operating Temperature Range		-55°C to +150°C	Temperature Cycle Chamber	
Capacitance		Within specified tolerance	Freq.: 1.0 kHz ± 10% Voltage: 1.0Vrms ± .2V	
Dissipation Factor		≤ 2.5% for ≥ 50V DC rating ≤ 3.5% for 25V DC and 16V DC rating		
Insulation Resistance		100,000MΩ or 1000MΩ - μF, whichever is less	Charge device with rated voltage for 120 ± 5 secs @ room temp/humidity	
Dielectric Strength		No breakdown or visual defects	Charge device with 250% of rated voltage for 1-5 seconds, w/charge and discharge current limited to 50 mA (max) Note: Charge device with 150% of rated voltage for 500V devices.	
Resistance to Flexure Stresses	Appearance	No defects	Deflection: 2mm Test Time: 30 seconds 1mm/sec 	
	Capacitance Variation	≤ ±12%		
	Dissipation Factor	Meets Initial Values (As Above)		
	Insulation Resistance	≥ Initial Value x 0.3		
Solderability		≥ 95% of each terminal should be covered with fresh solder	Dip device in eutectic solder at 230 ± 5°C for 5.0 ± 0.5 seconds	
Resistance to Solder Heat	Appearance	No defects, <25% leaching of either end terminal	Dip device in eutectic solder at 260°C for 60 seconds. Store at room temperature for 24 ± 2 hours before measuring electrical properties.	
	Capacitance Variation	≤ ±7.5%		
	Dissipation Factor	Meets Initial Values (As Above)		
	Insulation Resistance	Meets Initial Values (As Above)		
	Dielectric Strength	Meets Initial Values (As Above)		
Thermal Shock	Appearance	No visual defects	Step 1: -55°C ± 2°	30 ± 3 minutes
	Capacitance Variation	≤ ±7.5%	Step 2: Room Temp	≤ 3 minutes
	Dissipation Factor	Meets Initial Values (As Above)	Step 3: +125°C ± 2°	30 ± 3 minutes
	Insulation Resistance	Meets Initial Values (As Above)	Step 4: Room Temp	≤ 3 minutes
	Dielectric Strength	Meets Initial Values (As Above)	Repeat for 5 cycles and measure after 24 ± 2 hours at room temperature	
Load Life	Appearance	No visual defects	Charge device with 1.5 rated voltage (≤ 10V) in test chamber set at 150°C ± 2°C for 1000 hours (+48, -0)  Remove from test chamber and stabilize at room temperature for 24 ± 2 hours before measuring.	
	Capacitance Variation	≤ ±12.5%		
	Dissipation Factor	≤ Initial Value x 2.0 (See Above)		
	Insulation Resistance	≥ Initial Value x 0.3 (See Above)		
	Dielectric Strength	Meets Initial Values (As Above)		
Load Humidity	Appearance	No visual defects	Store in a test chamber set at 85°C ± 2°C/ 85% ± 5% relative humidity for 1000 hours (+48, -0) with rated voltage applied.  Remove from chamber and stabilize at room temperature and humidity for 24 ± 2 hours before measuring..	
	Capacitance Variation	≤ ±12.5%		
	Dissipation Factor	≤ Initial Value x 2.0 (See Above)		
	Insulation Resistance	≥ Initial Value x 0.3 (See Above)		
	Dielectric Strength	Meets Initial Values (As Above)		

# X7R Dielectric

## General Specifications



X7R formulations are called "temperature stable" ceramics and fall into EIA Class II materials. X7R is the most popular of these intermediate dielectric constant materials. Its temperature variation of capacitance is within  $\pm 15\%$  from  $-55^\circ\text{C}$  to  $+125^\circ\text{C}$ . This capacitance change is non-linear.

Capacitance for X7R varies under the influence of electrical operating conditions such as voltage and frequency. X7R dielectric chip usage covers the broad spectrum of industrial applications where known changes in capacitance due to applied voltages are acceptable.



### PART NUMBER (SEE PAGE 4 FOR COMPLETE PART NUMBER EXPLANATION)

**0805**

**Size**  
(L" x W")

**5**

**Voltage**  
4V = 4  
6.3V = 6  
10V = Z  
16V = Y  
25V = 3  
50V = 5  
100V = 1  
200V = 2  
500V = 7

**C**

**Dielectric**  
X7R = C

**103**

**Capacitance Code** (In pF)  
2 Sig. Digits + Number of Zeros

**M**

**Capacitance Tolerance**  
J =  $\pm 5\%$ \*  
K =  $\pm 10\%$   
M =  $\pm 20\%$

**A**

**Failure Rate**  
A = Not Applicable

**T**

**Terminations**  
T = Plated Ni and Sn  
7 = Gold Plated\*  
Z = FLEXITERM®\*\*

\*Optional termination  
\*\*See FLEXITERM® X7R section

**2**

**Packaging**  
2 = 7" Reel  
4 = 13" Reel

**Contact Factory For Multiples**

**A**

**Special Code**  
A = Std. Product

\* $\leq 1\mu\text{F}$  only,  
contact factory for additional values

NOTE: Contact factory for availability of Termination and Tolerance Options for Specific Part Numbers.  
Contact factory for non-specified capacitance values.

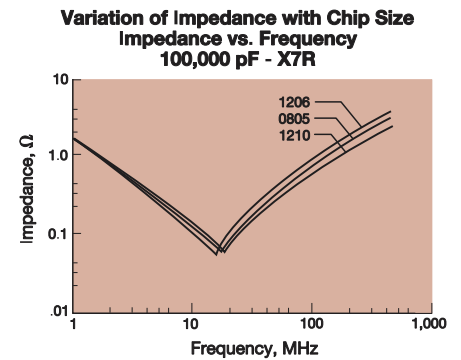
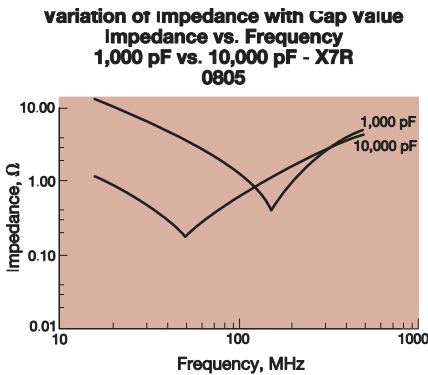
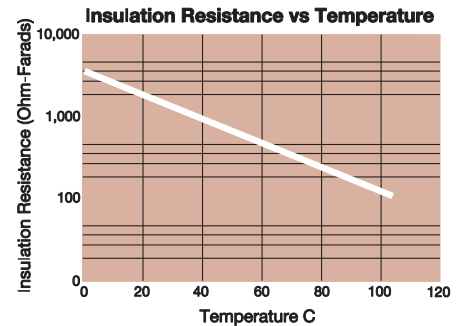
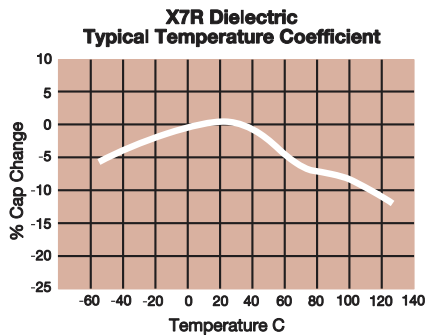

# X7R Dielectric

## Specifications and Test Methods



Parameter/Test		X7R Specification Limits	Measuring Conditions	
Operating Temperature Range		-55°C to +125°C	Temperature Cycle Chamber	
Capacitance		Within specified tolerance	Freq.: 1.0 kHz ± 10% Voltage: 1.0Vrms ± .2V For Cap > 10µF, 05Vrm @ 120Hz	
Dissipation Factor		≤ 10% for ≥ 50V DC ratings ≤ 12.5% for 25V and 16V DC rating ≤ 12.5% for ≤ 10V DC rating Contact Factory for DF by PN		
Insulation Resistance		100,000MΩ or 1000MΩ - µF, whichever is less	Charge device with rated voltage for 120 ± 5 secs @ room temp/humidity	
Dielectric Strength		No breakdown or visual defects	Charge device with 250% of rated voltage for 1-5 seconds, w/charge and discharge current limited to 50 mA (max) Note: Charge device with 150% of rated voltage for 500V devices.	
Resistance to Flexure Stresses	Appearance	No defects	Deflection: 2mm Test Time: 30 seconds	
	Capacitance Variation	≤ ±12%		
	Dissipation Factor	Meets Initial Values (As Above)		
	Insulation Resistance	≥ Initial Value x 0.3		
Solderability		≥ 95% of each terminal should be covered with fresh solder	Dip device in eutectic solder at 230 ± 5°C for 5.0 ± 0.5 seconds	
Resistance to Solder Heat	Appearance	No defects, <25% leaching of either end terminal	Dip device in eutectic solder at 260°C for 60 seconds. Store at room temperature for 24 ± 2 hours before measuring electrical properties.	
	Capacitance Variation	≤ ±7.5%		
	Dissipation Factor	Meets Initial Values (As Above)		
	Insulation Resistance	Meets Initial Values (As Above)		
	Dielectric Strength	Meets Initial Values (As Above)		
Thermal Shock	Appearance	No visual defects	Step 1: -55°C ± 2°	30 ± 3 minutes
	Capacitance Variation	≤ ±7.5%	Step 2: Room Temp	≤ 3 minutes
	Dissipation Factor	Meets Initial Values (As Above)	Step 3: +125°C ± 2°	30 ± 3 minutes
	Insulation Resistance	Meets Initial Values (As Above)	Step 4: Room Temp	≤ 3 minutes
	Dielectric Strength	Meets Initial Values (As Above)	Repeat for 5 cycles and measure after 24 ± 2 hours at room temperature	
Load Life	Appearance	No visual defects	Charge device with 1.5 rated voltage (≤ 10V) in test chamber set at 125°C ± 2°C for 1000 hours (+48, -0)  If RV > 10V then Life Test voltage will be 2xRV but there are exceptions (please contact AVX for further details on exceptions)  Remove from test chamber and stabilize at room temperature for 24 ± 2 hours before measuring.	
	Capacitance Variation	≤ ±12.5%		
	Dissipation Factor	≤ Initial Value x 2.0 (See Above)		
	Insulation Resistance	≥ Initial Value x 0.3 (See Above)		
	Dielectric Strength	Meets Initial Values (As Above)		
Load Humidity	Appearance	No visual defects	Store in a test chamber set at 85°C ± 2°C/ 85% ± 5% relative humidity for 1000 hours (+48, -0) with rated voltage applied.  Remove from chamber and stabilize at room temperature and humidity for 24 ± 2 hours before measuring.	
	Capacitance Variation	≤ ±12.5%		
	Dissipation Factor	≤ Initial Value x 2.0 (See Above)		
	Insulation Resistance	≥ Initial Value x 0.3 (See Above)		
	Dielectric Strength	Meets Initial Values (As Above)		

# X7R Dielectric Capacitance Range



## PREFERRED SIZES ARE SHADED

SIZE	0101*	0201	0402	0603	0805	1206
Soldering	Reflow Only	Reflow Only	Reflow/Wave	Reflow/Wave	Reflow/Wave	Reflow/Wave
Packaging	Paper/Embossed	All Paper	All Paper	All Paper	Paper/Embossed	Paper/Embossed
(L) Length	mm 0.40 ± 0.02 (0.016 ± 0.0008)	mm 0.60 ± 0.03 (0.024 ± 0.001)	mm 1.00 ± 0.10 (0.040 ± 0.004)	mm 1.60 ± 0.15 (0.063 ± 0.006)	mm 2.01 ± 0.20 (0.079 ± 0.008)	mm 3.20 ± 0.20 (0.126 ± 0.008)
W) Width	mm 0.20 ± 0.02 (0.008 ± 0.0008)	mm 0.30 ± 0.03 (0.011 ± 0.001)	mm 0.50 ± 0.10 (0.020 ± 0.004)	mm 0.81 ± 0.15 (0.032 ± 0.006)	mm 1.25 ± 0.20 (0.049 ± 0.008)	mm 1.60 ± 0.20 (0.063 ± 0.008)
(t) Terminal	mm 0.10 ± 0.04 (0.004 ± 0.0016)	mm 0.15 ± 0.05 (0.006 ± 0.002)	mm 0.25 ± 0.15 (0.010 ± 0.006)	mm 0.35 ± 0.15 (0.014 ± 0.006)	mm 0.50 ± 0.25 (0.020 ± 0.010)	mm 0.50 ± 0.25 (0.020 ± 0.010)
WVDC	16	63 10 16 25 50	63 10 16 25 50	63 10 16 25 50 100 200 250	63 10 16 25 50 100 200 250	63 10 16 25 50 100 200 250 500
Cap (pF)	100 101	B A A A A A	C C C C	G G G G	E E E E E E E	
	150 151	B A A A A A	C C C C	G G G G	J J J J J J J	
	220 221	B A A A A A	C C C C	G G G G	J J J J J J J	
	330 331	B A A A A A	C C C C	G G G G	J J J J J J J	K
	470 471	B A A A A A	C C C C	G G G G	J J J J J J J	K
	680 681	B A A A A A	C C C C	G G G G	J J J J J J J	K
	1000 102	B A A A A A	C C C C	G G G G G	J J J J J J J	J K
	1500 152	B A A A A A	C C C C C	G G G J G	J J J J J J J	J J J J J J J M
	2200 222	B A A A A A	C C C C C	G G J J G	J J J J J J J	J J J J J J J M
	3300 332	A A A A A	C C C C C	G G J J G	J J J J J J J	J J J J J J J M
	4700 472	A A A A A	C C C C C	G G J J G	J J J J J J J	J J J J J J J M
	6800 682	A A A A A	C C C C C	G G J J G	J J J J J J J	J J J J J J J P
Cap (µF)	0.01 103	A A A A A	C C C C C	G G G J G	J J J J J J J	J J J J J J J P
	0.015 153		C C C C C	G G G J	J J J J J J N	J J J J J J M J Q
	0.022 223		C C C C C	G G G	J J J J J N N	J J J J J M J Q
	0.033 333		C C C C C	G G J	J J J J N N N	J J J J J M J Q
	0.047 473		C C C C C	G G J J	J J J J N N N	J J J J J M M
	0.068 683		C C C C C	G G G J	J J J J N N	J J J J J P M
	0.1 104		C C C C C	G G G G J	J J J J N N	J J J J P P P
	0.15 154			G G G G J	J J J N N	J J J J Q Q Q
	0.22 224		C C C C	G G J J J	J J N N N	J J J J Q Q Q
	0.33 334			J J J J J	N N N N N	J J M P Q
	0.47 474		C C	J J J J J	N N N N N	M M M P Q
	0.68 684			J J J J	N N N	M M
	1.0 105		C	J J J J J	N N N N	M M
	2.2 225			J J J	P P P P**	Q Q Q Q Q Q**
	4.7 475			J	P P P	Q Q Q Z
	10 106				P P P	Q Q X X
	22 226					X Q Q
	47 476					Q Q
	100 107					
WVDC	16	63 10 16 25 50	63 10 16 25 50	63 10 16 25 50 100 200 250	63 10 16 25 50 100 200 250	63 10 16 25 50 100 200 250 500
SIZE	0101*	0201	0402	0603	0805	1206

Letter	A	B	C	E	G	J	K	M	N	P	Q	X	Y	Z
Max. Thickness	0.33 (0.013)	0.22 (0.009)	0.56 (0.022)	0.71 (0.028)	0.90 (0.035)	0.94 (0.037)	1.02 (0.040)	1.27 (0.050)	1.40 (0.055)	1.52 (0.060)	1.78 (0.070)	2.29 (0.090)	2.54 (0.100)	2.79 (0.110)
	PAPER						EMBOSSSED							

NOTE: Contact factory for non-specified capacitance values

\*EIA 01005

\*\*Contact Factory for Specifications



# X7S Dielectric

## General Specifications



### GENERAL DESCRIPTION

X7S formulations are called "temperature stable" ceramics and fall into EIA Class II materials. Its temperature variation of capacitance is within  $\pm 22\%$  from  $-55^{\circ}\text{C}$  to  $+125^{\circ}\text{C}$ . This capacitance change is non-linear.

Capacitance for X7S varies under the influence of electrical operating conditions such as voltage and frequency.

X7S dielectric chip usage covers the broad spectrum of industrial applications where known changes in capacitance due to applied voltages are acceptable.

### PART NUMBER (SEE PAGE 4 FOR COMPLETE PART NUMBER EXPLANATION)

**1206**

**Size**  
(L" x W")

**Z**

**Voltage**  
4 = 4V  
6 = 6.3V  
Z = 10V  
Y = 16V  
3 = 25V  
5 = 50V  
1 = 100V  
2 = 200V

**Z**

**Dielectric**  
Z = X7S

**105**

**Capacitance Code (In pF)**  
2 Sig. Digits + Number of Zeros

**M**

**Capacitance Tolerance**  
K =  $\pm 10\%$   
M =  $\pm 20\%$

**A**

**Failure Rate**  
A = N/A

**T**

**Terminations**  
T = Plated Ni and Sn

**2**

**Packaging**  
2 = 7" Reel  
4 = 13" Reel

**A**

**Special Code**  
A = Std. Product



NOTE: Contact factory for availability of Tolerance Options for Specific Part Numbers.

### TYPICAL ELECTRICAL CHARACTERISTICS

**X7S Dielectric Typical Temperature Coefficient**

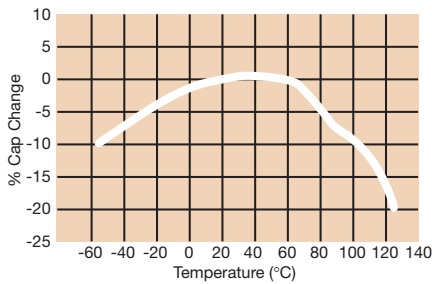

**Δ Capacitance vs. Frequency**

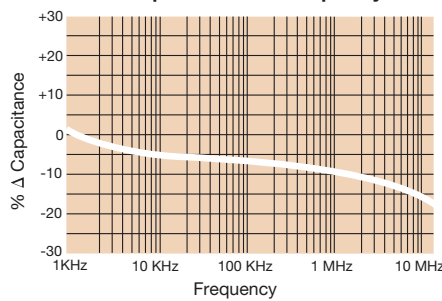

**Insulation Resistance vs Temperature**



**Variation of Impedance with Cap Value Impedance vs. Frequency 1,000 pF vs. 10,000 pF - X7S 0805**



**Variation of Impedance with Chip Size Impedance vs. Frequency 10,000 pF - X7S**



**Variation of Impedance with Chip Size Impedance vs. Frequency 100,000 pF - X7S**

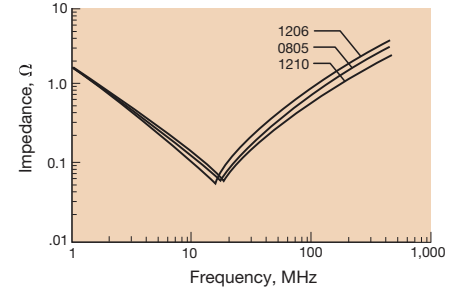

Parameter/Test		X7S Specification Limits	Measuring Conditions	
Operating Temperature Range		-55°C to +125°C	Temperature Cycle Chamber	
Capacitance		Within specified tolerance	Freq.: 1.0 kHz $\pm$ 10% Voltage: 1.0Vrms $\pm$ .2V For Cap > 10 $\mu$ F, 0.5Vrms @ 120Hz	
Dissipation Factor		$\leq$ 5.0% for $\geq$ 100V DC rating $\leq$ 5.0% for $\geq$ 25V DC rating $\leq$ 10.0% for $\geq$ 10V DC rating $\leq$ 10.0% for $\leq$ 10V DC rating		
Insulation Resistance		100,000M $\Omega$ or 1000M $\Omega$ - $\mu$ F, whichever is less	Charge device with rated voltage for 120 $\pm$ 5 secs @ room temp/humidity	
Dielectric Strength		No breakdown or visual defects	Charge device with 250% of rated voltage for 1-5 seconds, w/charge and discharge current limited to 50 mA (max)	
Resistance to Flexure Stresses	Appearance	No defects	Deflection: 2mm Test Time: 30 seconds 	
	Capacitance Variation	$\leq$ $\pm$ 12%		
	Dissipation Factor	Meets Initial Values (As Above)		
	Insulation Resistance	$\geq$ Initial Value x 0.3		
Solderability		$\geq$ 95% of each terminal should be covered with fresh solder	Dip device in eutectic solder at 230 $\pm$ 5°C for 5.0 $\pm$ 0.5 seconds	
Resistance to Solder Heat	Appearance	No defects, <25% leaching of either end terminal	Dip device in eutectic solder at 260°C for 60 seconds. Store at room temperature for 24 $\pm$ 2 hours before measuring electrical properties.	
	Capacitance Variation	$\leq$ $\pm$ 7.5%		
	Dissipation Factor	Meets Initial Values (As Above)		
	Insulation Resistance	Meets Initial Values (As Above)		
	Dielectric Strength	Meets Initial Values (As Above)		
Thermal Shock	Appearance	No visual defects	Step 1: -55°C $\pm$ 2°	30 $\pm$ 3 minutes
	Capacitance Variation	$\leq$ $\pm$ 7.5%	Step 2: Room Temp	$\leq$ 3 minutes
	Dissipation Factor	Meets Initial Values (As Above)	Step 3: +125°C $\pm$ 2°	30 $\pm$ 3 minutes
	Insulation Resistance	Meets Initial Values (As Above)	Step 4: Room Temp	$\leq$ 3 minutes
	Dielectric Strength	Meets Initial Values (As Above)	Repeat for 5 cycles and measure after 24 $\pm$ 2 hours at room temperature	
Load Life	Appearance	No visual defects	Charge device with 1.5 rated voltage ( $\leq$ 10V) in test chamber set at 125°C $\pm$ 2°C for 1000 hours (+48, -0)  Remove from test chamber and stabilize at room temperature for 24 $\pm$ 2 hours before measuring.	
	Capacitance Variation	$\leq$ $\pm$ 12.5%		
	Dissipation Factor	$\leq$ Initial Value x 2.0 (See Above)		
	Insulation Resistance	$\geq$ Initial Value x 0.3 (See Above)		
Load Humidity	Appearance	No visual defects	Store in a test chamber set at 85°C $\pm$ 2°C/ 85% $\pm$ 5% relative humidity for 1000 hours (+48, -0) with rated voltage applied.  Remove from chamber and stabilize at room temperature and humidity for 24 $\pm$ 2 hours before measuring.	
	Capacitance Variation	$\leq$ $\pm$ 12.5%		
	Dissipation Factor	$\leq$ Initial Value x 2.0 (See Above)		
	Insulation Resistance	$\geq$ Initial Value x 0.3 (See Above)		
	Dielectric Strength	Meets Initial Values (As Above)		

# X7S Dielectric Capacitance Range



PREFERRED SIZES ARE SHADED

SIZE	0402	0603	0805	1206	1210
<b>Soldering</b>	Reflow/Wave	Reflow/Wave	Reflow/Wave	Reflow/Wave	Reflow Only
<b>Packaging</b>	All Paper	All Paper	Paper/Embossed	Paper/Embossed	Paper/Embossed
(L) Length	mm (in.)	mm (in.)	mm (in.)	mm (in.)	mm (in.)
(W) Width	mm (in.)	mm (in.)	mm (in.)	mm (in.)	mm (in.)
(t) Terminal	mm (in.)	mm (in.)	mm (in.)	mm (in.)	mm (in.)
WVDC	6.3	6.3	4	10   50   100	6.3
Cap (pF)	100 150 220 330 470 680 1000 1500 2200				
Cap (µF)	0.010 0.015 0.022 0.033 0.047 0.068 0.10 0.15 0.22 0.33 0.47 0.68 1.0 1.5 2.2 3.3 4.7 10 22 47 100				
	C				
	C				
	C				
	C				
		G			
		G			
		G			
		G			
			N		
			N		
			N		
			N	Q	Q*
					Z
WVDC	6.3	6.3	4	10   50   100	6.3
<b>SIZE</b>	<b>0402</b>	<b>0603</b>	<b>0805</b>	<b>1206</b>	<b>1210</b>

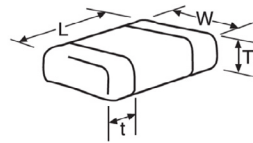

Letter	A	C	E	G	J	K	M	N	P	Q	X	Y	Z
Max. Thickness	0.33 (0.013)	0.56 (0.022)	0.71 (0.028)	0.90 (0.035)	0.94 (0.037)	1.02 (0.040)	1.27 (0.050)	1.40 (0.055)	1.52 (0.060)	1.90 (0.075)	2.29 (0.090)	2.54 (0.100)	2.79 (0.110)
	PAPER					EMBOSSSED							

\*Contact Factory for Specifications

# X5R Dielectric

## General Specifications



### GENERAL DESCRIPTION

- General Purpose Dielectric for Ceramic Capacitors
- EIA Class II Dielectric
- Temperature variation of capacitance is within  $\pm 15\%$  from  $-55^{\circ}\text{C}$  to  $+85^{\circ}\text{C}$
- Well suited for decoupling and filtering applications
- Available in High Capacitance values (up to  $100\mu\text{F}$ )

### PART NUMBER (SEE PAGE 4 FOR COMPLETE PART NUMBER EXPLANATION)

1210	4	D	107	M	A	T	2	A
<b>Size</b> (L" x W") 0101** 0201 0402 0603 0805 1206 1210 1812 **EIA 01005	<b>Voltage</b> 4 = 4V 6 = 6.3V Z = 10V Y = 16V 3 = 25V D = 35V 5 = 50V 1 = 100V	<b>Dielectric</b> D = X5R	<b>Capacitance Code (In pF)</b> 2 Sig. Digits + Number of Zeros	<b>Capacitance Tolerance</b> K = $\pm 10\%$ M = $\pm 20\%$	<b>Failure Rate</b> A = N/A	<b>Terminations</b> T = Plated Ni and Sn	<b>Packaging</b> 2 = 7" Reel 4 = 13" Reel U = 4mm TR (01005)	<b>Special Code</b> A = Std.



NOTE: Contact factory for availability of Tolerance Options for Specific Part Numbers.  
Contact factory for non-specified capacitance values.

### TYPICAL ELECTRICAL CHARACTERISTICS



# X5R Dielectric

## Specifications and Test Methods



Parameter/Test		X5R Specification Limits	Measuring Conditions	
Operating Temperature Range		-55°C to +85°C	Temperature Cycle Chamber	
Capacitance		Within specified tolerance		
Dissipation Factor		$\leq 2.5\%$ for $\geq 50V$ DC rating $\leq 12.5\%$ for 25V, 35V DC rating $\leq 12.5\%$ Max. for 16V DC rating and lower Contact Factory for DF by PN	Freq.: 1.0 kHz $\pm 10\%$ Voltage: 1.0Vrms $\pm .2V$ For Cap > 10 $\mu F$ , 0.5Vrms @ 120Hz	
Insulation Resistance		10,000M $\Omega$ or 500M $\Omega$ - $\mu F$ , whichever is less	Charge device with rated voltage for 120 $\pm 5$ secs @ room temp/humidity	
Dielectric Strength		No breakdown or visual defects	Charge device with 250% of rated voltage for 1-5 seconds, w/charge and discharge current limited to 50 mA (max)	
Resistance to Flexure Stresses	Appearance	No defects	Deflection: 2mm Test Time: 30 seconds 1mm/sec 	
	Capacitance Variation	$\leq \pm 12\%$		
	Dissipation Factor	Meets Initial Values (As Above)		
	Insulation Resistance	$\geq$ Initial Value x 0.3		
Solderability		$\geq 95\%$ of each terminal should be covered with fresh solder	Dip device in eutectic solder at 230 $\pm 5^\circ C$ for 5.0 $\pm 0.5$ seconds	
Resistance to Solder Heat	Appearance	No defects, <25% leaching of either end terminal	Dip device in eutectic solder at 260°C for 60seconds. Store at room temperature for 24 $\pm$ 2hours before measuring electrical properties.	
	Capacitance Variation	$\leq \pm 7.5\%$		
	Dissipation Factor	Meets Initial Values (As Above)		
	Insulation Resistance	Meets Initial Values (As Above)		
	Dielectric Strength	Meets Initial Values (As Above)		
Thermal Shock	Appearance	No visual defects	Step 1: -55°C $\pm 2^\circ$	30 $\pm 3$ minutes
	Capacitance Variation	$\leq \pm 7.5\%$	Step 2: Room Temp	$\leq 3$ minutes
	Dissipation Factor	Meets Initial Values (As Above)	Step 3: +85°C $\pm 2^\circ$	30 $\pm 3$ minutes
	Insulation Resistance	Meets Initial Values (As Above)	Step 4: Room Temp	$\leq 3$ minutes
	Dielectric Strength	Meets Initial Values (As Above)	Repeat for 5 cycles and measure after 24 $\pm 2$ hours at room temperature	
Load Life	Appearance	No visual defects	Charge device with 1.5X rated voltage in test chamber set at 85°C $\pm 2^\circ C$ for 1000 hours (+48, -0).  Note: Contact factory for *optional specification part numbers that are tested at < 1.5X rated voltage.  Remove from test chamber and stabilize at room temperature for 24 $\pm 2$ hours	
	Capacitance Variation	$\leq \pm 12.5\%$		
	Dissipation Factor	$\leq$ Initial Value x 2.0 (See Above)		
	Insulation Resistance	$\geq$ Initial Value x 0.3 (See Above)		
	Dielectric Strength	Meets Initial Values (As Above)		
Load Humidity	Appearance	No visual defects	Store in a test chamber set at 85°C $\pm 2^\circ C$ / 85% $\pm 5\%$ relative humidity for 1000 hours (+48, -0) with rated voltage applied.  Remove from chamber and stabilize at room temperature and humidity for 24 $\pm 2$ hours before measuring.	
	Capacitance Variation	$\leq \pm 12.5\%$		
	Dissipation Factor	$\leq$ Initial Value x 2.0 (See Above)		
	Insulation Resistance	$\geq$ Initial Value x 0.3 (See Above)		
	Dielectric Strength	Meets Initial Values (As Above)		

# X5R Dielectric Capacitance Range



PREFERRED SIZES ARE SHADED

Case Size	0101*		0201				0402					0603					0805											
Soldering	Reflow Only		Reflow Only				Reflow/Wave					Reflow/Wfeve					Reflow/Wfeve											
Packaging	Paper/Embossed		All Paper				All Paper					All Paper					Paper/Embossed											
(L) Length	mm	0.40 ± 0.02	0.60 ± 0.09				1.00 ± 0.15					1.60 ± 0.15					2.01 ± 0.20											
(W) Width	mm	0.20 ± 0.02	0.30 ± 0.09				0.50 ± 0.15					0.81 ± 0.15					1.25 ± 0.20											
(t) Terminal	mm	0.10 ± 0.04	0.15 ± 0.05				0.25 ± 0.15					0.35 ± 0.15					0.50 ± 0.25											
	(in.)	(0.004 ± 0.0016)	(0.006 ± 0.002)				(0.010 ± 0.006)					(0.014 ± 0.006)					(0.020 ± 0.010)											
Voltage:		63	16	4	63	10	16	25	4	63	10	16	25	50	4	63	10	16	25	35	50	4	63	10	16	25	35	50
Cap (pF)	100	101	B					A																				
	150	151	B					A																				
	220	221	B					A						C														
	330	331	B					A						C														
	470	471	B					A						C														
	680	681	B					A						C														
	1000	102	B				A	A						C														
	1500	152	B	B				A	A					C														
	2200	222	B	B			A	A	A					C														
	3300	332	B	B			A	A	A					C														
	4700	472	B	B			A	A	A					C														
	6800	682	B	B			A	A	A					C														
Cap (µF)	0.01	103	B	B			A	A	A					C														
	0.015	150	B											C														
	0.022	223	B			A	A	A	A					C	C													N
	0.033	333	B											C														N
	0.047	473	B			A	A	A	A					C	C													N
	0.068	689	B											C														N
	0.1	104	B			A	A	A	A					C	C	C	C											N
	0.15	154												C														N
	0.22	224	B			A	A	A						C	C	C	C	C										N
	0.33	334												C														N
	0.47	474	B			A	A							C	C	C	C	C	E									N
	0.68	684												C														P
	1.0	105				A	A	C	C					C	C	C	C	C	E									N
	1.5	155												C														N
	2.2	225				C	C	C						C	C	C	C	C										N
	3.3	335												C														N
	4.7	475				C								E	E	E	E											N
	10	106												E	E	E												N
	22	226												E	E													N
	47	476																										N
	100	107																										N
Voltage:		63	16	4	63	10	16	25	4	63	10	16	25	50	4	63	10	16	25	35	50	4	63	10	16	25	35	50

Letter	A	B	C	E	G		K	M	N	P	Q	X	Y	Z
Max. Thickness	0.33	0.22	0.56	0.71	0.90	0.94	1.02	1.27	1.40	1.52	1.78	2.29	2.54	2.79
	(0.013)	(0.009)	(0.022)	(0.028)	(0.035)	(0.037)	(0.040)	(0.050)	(0.055)	(0.060)	(0.070)	(0.090)	(0.100)	(0.110)
	PAPER						EMBOSSSED							

PAPER and EMBOSSSED available for 01005

NOTE: Contact factory for non-specified capacitance values

\*EIA 01005

# X5R Dielectric Capacitance Range



## PREFERRED SIZES ARE SHADED

Case Size	1206								1210								1812							
Soldering	Reflow/Wave								Reflow Only								Reflow Only							
Packaging	Paper/Embossed								Paper/Embossed								All Embossed							
(L) Length	3.20 ± 0.20 (0.126 ± 0.008)								3.20 ± 0.20 (0.126 ± 0.008)								4.50 ± 0.30 (0.177 ± 0.012)							
W) Width	1.60 ± 0.20 (0.063 ± 0.008)								2.50 ± 0.20 (0.098 ± 0.008)								3.20 ± 0.20 (0.126 ± 0.008)							
(t) Terminal	0.50 ± 0.25 (0.020 ± 0.010)								0.50 ± 0.25 (0.020 ± 0.010)								0.61 ± 0.36 (0.024 ± 0.014)							
Voltage:	4	6.3	10	16	25	35	50	4	6.3	10	16	25	35	50	4	6.3	10	16	25	35	50			
Cap (pF)	100	101																						
	150	151																						
	220	221																						
	330	331																						
	470	471																						
	680	681																						
	1000	102																						
	1500	152																						
	2200	222																						
	3300	332																						
	4700	472																						
	6800	682																						
Cap (µF)	0.01	103																						
	0.015	150																						
	0.022	223																						
	0.033	333																						
	0.047	473																						
	0.068	689																						
	0.1	104																						
	0.15	154																						
	0.22	224																						
	0.33	334																						
	0.47	474			Q	Q								X	X									
	0.68	684																						
	1.0	105			Q	Q	Q						X	X	X									
	1.5	155																						
	2.2	225		Q	Q	Q	Q						X	Z	Z									
	3.3	335		Q	Q																			
	4.7	475	X	X	X	X	X				Z	Z	Z	Z	Z									
	10	106	X	X	X	X	X	X	X	X	Z	Z	Z	Z	Z					Z				
	22	226	X	X	X	X	X	Z	Z	Z	Z	Z	Z	Z	Z	Z	Z	Z						
	47	476	X	X	X	X		Z	Z	Z	Z	Z												
	100	107	X	X				Z	Z	Z	Z													
Voltage:	4	6.3	10	16	25	35	50	4	6.3	10	16	25	35	50	4	6.3	10	16	25	35	50			
Case Size	1206								1210								1812							

Letter	A	B	C	E	G	J	K	M	N	P	Q	X	Y	Z
Max. Thickness	0.33 (0.013)	0.22 (0.009)	0.56 (0.022)	0.71 (0.028)	0.90 (0.035)	0.94 (0.037)	1.02 (0.040)	1.27 (0.050)	1.40 (0.055)	1.52 (0.060)	1.78 (0.070)	2.29 (0.090)	2.54 (0.100)	2.79 (0.110)
	PAPER						EMBOSSSED							

PAPER and EMBOSSSED available for 01005

NOTE: Contact factory for non-specified capacitance values

\*EIA 01005

# Y5V Dielectric

## General Specifications



### GENERAL DESCRIPTION

Y5V formulations are for general-purpose use in a limited temperature range. They have a wide temperature characteristic of +22% -82% capacitance change over the operating temperature range of -30°C to +85°C.

These characteristics make Y5V ideal for decoupling applications within limited temperature range.



### PART NUMBER (SEE PAGE 4 FOR COMPLETE PART NUMBER EXPLANATION)

**0805**

**Size**  
(L" x W")

**3**

**Voltage**  
6.3V = 6  
10V = Z  
16V = Y  
25V = 3  
50V = 5

**G**

**Dielectric**  
Y5V = G

**104**

**Capacitance Code (In pF)**  
2 Sig. Digits + Number of Zeros

**Z**

**Capacitance Tolerance**  
Z = +80 -20%

**A**

**Failure Rate**  
A = Not Applicable

**T**

**Terminations**  
T = Plated Ni and Sn

**2**

**Packaging**  
2 = 7" Reel  
4 = 13" Reel

**A**

**Special Code**  
A = Std. Product

**Temperature Coefficient**



**Capacitance Change vs. DC Bias Voltage**

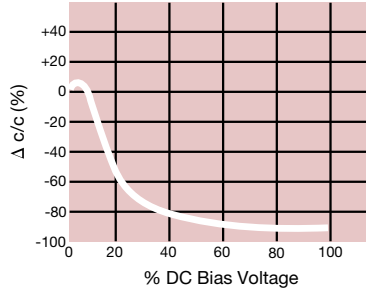

**Insulation Resistance vs. Temperature**

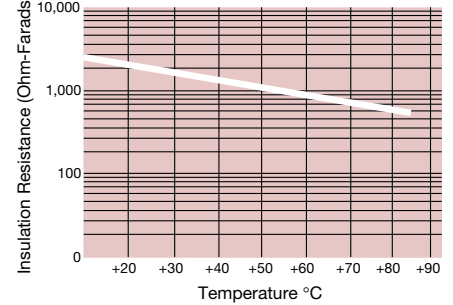

**0.1 μF - 0603 Impedance vs. Frequency**



**0.22 μF - 0805 Impedance vs. Frequency**



**1 μF - 1206 Impedance vs. Frequency**

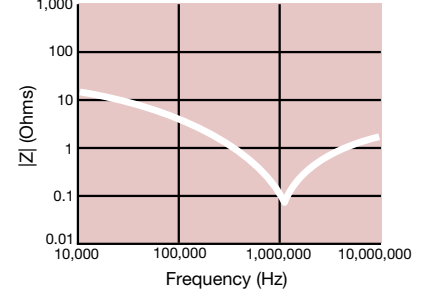

# Y5V Dielectric

## Specifications and Test Methods



Parameter/Test		Y5V Specification Limits	Measuring Conditions	
Operating Temperature Range		-30°C to +85°C	Temperature Cycle Chamber	
Capacitance		Within specified tolerance	Freq.: 1.0 kHz ± 10% Voltage: 1.0Vrms ± .2V For Cap > 10 µF, 0.5Vrms @ 120Hz	
Dissipation Factor		≤ 5.0% for ≥ 50V DC rating ≤ 7.0% for 25V DC rating ≤ 9.0% for 16V DC rating ≤ 12.5% for ≤ 10V DC rating		
Insulation Resistance		10,000MΩ or 500MΩ - µF, whichever is less		
Dielectric Strength		No breakdown or visual defects	Charge device with 250% of rated voltage for 1-5 seconds, w/charge and discharge current limited to 50 mA (max)	
Resistance to Flexure Stresses	Appearance	No defects	Deflection: 2mm Test Time: 30 seconds 1mm/sec 	
	Capacitance Variation	≤ ±30%		
	Dissipation Factor	Meets Initial Values (As Above)		
	Insulation Resistance	≥ Initial Value x 0.1		
Solderability		≥ 95% of each terminal should be covered with fresh solder	Dip device in eutectic solder at 230 ± 5°C for 5.0 ± 0.5 seconds	
Resistance to Solder Heat	Appearance	No defects, <25% leaching of either end terminal	Dip device in eutectic solder at 260°C for 60 seconds. Store at room temperature for 24 ± 2 hours before measuring electrical properties.	
	Capacitance Variation	≤ ±20%		
	Dissipation Factor	Meets Initial Values (As Above)		
	Insulation Resistance	Meets Initial Values (As Above)		
	Dielectric Strength	Meets Initial Values (As Above)		
Thermal Shock	Appearance	No visual defects	Step 1: -30°C ± 2°	30 ± 3 minutes
	Capacitance Variation	≤ ±20%	Step 2: Room Temp	≤ 3 minutes
	Dissipation Factor	Meets Initial Values (As Above)	Step 3: +85°C ± 2°	30 ± 3 minutes
	Insulation Resistance	Meets Initial Values (As Above)	Step 4: Room Temp	≤ 3 minutes
	Dielectric Strength	Meets Initial Values (As Above)	Repeat for 5 cycles and measure after 24 ± 2 hours at room temperature	
Load Life	Appearance	No visual defects	Charge device with twice rated voltage in test chamber set at 85°C ± 2°C for 1000 hours (+48, -0)  Remove from test chamber and stabilize at room temperature for 24 ± 2 hours before measuring.	
	Capacitance Variation	≤ ±30%		
	Dissipation Factor	≤ Initial Value x 1.5 (See Above)		
	Insulation Resistance	≥ Initial Value x 0.1 (See Above)		
	Dielectric Strength	Meets Initial Values (As Above)		
Load Humidity	Appearance	No visual defects	Store in a test chamber set at 85°C ± 2°C/ 85% ± 5% relative humidity for 1000 hours (+48, -0) with rated voltage applied.  Remove from chamber and stabilize at room temperature and humidity for 24 ± 2 hours before measuring.	
	Capacitance Variation	≤ ±30%		
	Dissipation Factor	≤ Initial Value x 1.5 (See above)		
	Insulation Resistance	≥ Initial Value x 0.1 (See Above)		
	Dielectric Strength	Meets Initial Values (As Above)		

# Y5V Dielectric Capacitance Range



PREFERRED SIZES ARE SHADED

SIZE	0201				0402				0603				0805				1206				1210				
Soldering	Reflow Only				Reflow/Wave				Reflow/Wave				Reflow/Wave				Reflow/Wave				Reflow/Wave				
Packaging	All Paper				All Paper				All Paper				Paper/Embossed				Paper/Embossed				Paper/Embossed				
(L) Length	mm	0.60 ± 0.09			1.00 ± 0.10				1.60 ± 0.15				2.01 ± 0.20				3.20 ± 0.20				3.20 ± 0.20				
	(in.)	(0.024 ± 0.004)			(0.040 ± 0.004)				(0.063 ± 0.006)				(0.079 ± 0.008)				(0.126 ± 0.008)				(0.126 ± 0.008)				
(W) Width	mm	0.30 ± 0.09			0.50 ± 0.10				.81 ± 0.15				1.25 ± 0.20				1.60 ± 0.20				2.50 ± 0.20				
	(in.)	(0.011 ± 0.004)			(0.020 ± 0.004)				(0.032 ± 0.006)				(0.049 ± 0.008)				(0.063 ± 0.008)				(0.098 ± 0.008)				
(t) Terminal	mm	0.15 ± 0.05			0.25 ± 0.15				0.35 ± 0.15				0.50 ± 0.25				0.50 ± 0.25				.50 ± 0.25				
	(in.)	(0.006 ± 0.002)			(0.010 ± 0.006)				(0.014 ± 0.006)				(0.020 ± 0.010)				(0.020 ± 0.010)				(0.020 ± 0.010)				
WVDC		63	10	6	10	16	25	50	10	16	25	50	10	16	25	50	10	16	25	50	10	16	25	50	
Cap (pF)	820																								
	1000		A																						
	2200		A																						
	4700		A																						
Cap (µF)	0.010	A	A																						
	0.022	A																							
	0.047	A																							
	0.10				C	C																			
	0.22									G	G					K									
	0.33									G															
	0.47					C				G	G														
	1.0				C	C				G	G	J			N	N	N				M	M	M		N
	2.2					C				J					N	N	N					K	Q		
	4.7														N	N	N					P	Q	X	
	10.0														N	P						Q	Q	X	
	22.0																					Q			
	47.0																							X	Z
WVDC		63	10	6	10	16	25	50	10	16	25	50	10	16	25	50	10	16	25	50	10	16	25	50	
SIZE		0201				0402				0603				0805				1206				1210			



Letter	A	C	E	G	J	K	M	N	P	Q	X	Y	Z
Max.	0.33	0.56	0.71	0.90	0.94	1.02	1.27	1.40	1.52	1.78	2.29	2.54	2.79
Thickness	(0.013)	(0.022)	(0.028)	(0.035)	(0.037)	(0.040)	(0.050)	(0.055)	(0.060)	(0.070)	(0.090)	(0.100)	(0.110)
	PAPER					EMBOSSSED							

# MLCC Gold Termination – AU Series



## General Specifications

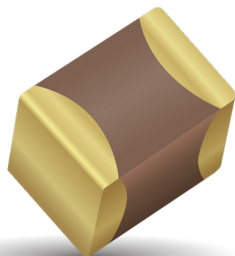

AVX Corporation will support those customers for commercial and military Multilayer Ceramic Capacitors with a termination consisting of Gold. This termination is indicated by the use of a "7" or "G" in the 12th position of the AVX Catalog Part Number. This fulfills AVX's commitment to providing a full range of products to our customers. Please contact the factory if you require additional information on our MLCC Gold Termination.

## PART NUMBER

<b>AU03</b>	<b>Y</b>	<b>G</b>	<b>104</b>	<b>K</b>	<b>A</b>	<b>7</b>	<b>2</b>	<b>A</b>
Size	Voltage	Dielectric	Capacitance Code (In pF)	Capacitance Tolerance	Failure Rate	Terminations	Packaging	Special Code
AU01 - 0201 AU02 - 0402 AU03 - 0603 AU05 - 0805 AU06 - 1206 AU10 - 1210 AU12 - 1812 AU13 - 1825 AU14 - 2225 AU16 - 0306 AU17 - 0508 AU18 - 0612	6.3V = 6 10V = Z 16V = Y 25V = 3 35V = D 50V = 5 100V = 1 200V = 2 500V = 7	C0G (NP0) = A X7R = C X5R = D	2 Sig. Digits + Number of Zeros	B = ±10 pF (<10pF) C = ±25 pF (<10pF) D = ±50 pF (<10pF) F = ±1% (≥ 10 pF) G = ±2% (≥ 10 pF) J = ±5% K = ±10% M = ±20%	A = Not Applicable	G* = 1.9 μ" to 7.87 μ"  7 = 100 μ" minimum	2 = 7" Reel 4 = 13" Reel U = 4mm TR (01005)  <b>Contact Factory For Multiples*</b>	A = Std. Product

\* Contact factory for availability.

# MLCC Gold Termination – AU Series

## Capacitance Range (NP0 Dielectric)



### PREFERRED SIZES ARE SHADED

SIZE	AU01		AU02			AU03				AU05					AU06					
Soldering	Reflow/Epoxy/ Wire Bond*		Reflow/Epoxy/ Wire Bond*			Reflow/Epoxy/ Wire Bond*				Reflow/Epoxy/ Wire Bond*					Reflow/Epoxy/ Wire Bond*					
Packaging	All Paper		All Paper			All Paper				Paper/Embossed					Paper/Embossed					
(L) Length	0.60 ± 0.09 (0.024 ± 0.004)		1.00 ± 0.10 (0.040 ± 0.004)			1.60 ± 0.15 (0.063 ± 0.006)				2.01 ± 0.20 (0.079 ± 0.008)					3.20 ± 0.20 (0.126 ± 0.008)					
(W) Width	0.30 ± 0.09 (0.011 ± 0.004)		0.50 ± 0.10 (0.020 ± 0.004)			0.81 ± 0.15 (0.032 ± 0.006)				1.25 ± 0.20 (0.049 ± 0.008)					1.60 ± 0.20 (0.063 ± 0.008)					
(t) Terminal	0.15 ± 0.05 (0.006 ± 0.002)		0.25 ± 0.15 (0.010 ± 0.006)			0.35 ± 0.15 (0.014 ± 0.006)				0.50 ± 0.25 (0.020 ± 0.010)					0.50 ± 0.25 (0.020 ± 0.010)					
Cap (pF)	16	25	16	25	50	16	25	50	100	16	25	50	100	200	16	25	50	100	200	500
0.5	A	A	C	C	C	G	G	G	G	J	J	J	J	J	J	J	J	J	J	J
1.0	A	A	C	C	C	G	G	G	G	J	J	J	J	J	J	J	J	J	J	J
1.2	A	A	C	C	C	G	G	G	G	J	J	J	J	J	J	J	J	J	J	J
1.5	A	A	C	C	C	G	G	G	G	J	J	J	J	J	J	J	J	J	J	J
1.8	A	A	C	C	C	G	G	G	G	J	J	J	J	J	J	J	J	J	J	J
2.2	A	A	C	C	C	G	G	G	G	J	J	J	J	J	J	J	J	J	J	J
2.7	A	A	C	C	C	G	G	G	G	J	J	J	J	J	J	J	J	J	J	J
3.3	A	A	C	C	C	G	G	G	G	J	J	J	J	J	J	J	J	J	J	J
3.9	A	A	C	C	C	G	G	G	G	J	J	J	J	J	J	J	J	J	J	J
4.7	A	A	C	C	C	G	G	G	G	J	J	J	J	J	J	J	J	J	J	J
5.6	A	A	C	C	C	G	G	G	G	J	J	J	J	J	J	J	J	J	J	J
6.8	A	A	C	C	C	G	G	G	G	J	J	J	J	J	J	J	J	J	J	J
8.2	A	A	C	C	C	G	G	G	G	J	J	J	J	J	J	J	J	J	J	J
10	A	A	C	C	C	G	G	G	G	J	J	J	J	J	J	J	J	J	J	J
12	A	A	C	C	C	G	G	G	G	J	J	J	J	J	J	J	J	J	J	J
15	A	A	C	C	C	G	G	G	G	J	J	J	J	J	J	J	J	J	J	J
18	A	A	C	C	C	G	G	G	G	J	J	J	J	J	J	J	J	J	J	J
22	A	A	C	C	C	G	G	G	G	J	J	J	J	J	J	J	J	J	J	J
27	A	A	C	C	C	G	G	G	G	J	J	J	J	J	J	J	J	J	J	J
33	A	A	C	C	C	G	G	G	G	J	J	J	J	J	J	J	J	J	J	J
39	A	A	C	C	C	G	G	G	G	J	J	J	J	J	J	J	J	J	J	J
47	A	A	C	C	C	G	G	G	G	J	J	J	J	J	J	J	J	J	J	J
56	A	A	C	C	C	G	G	G	G	J	J	J	J	J	J	J	J	J	J	J
68	A	A	C	C	C	G	G	G	G	J	J	J	J	J	J	J	J	J	J	J
82	A	A	C	C	C	G	G	G	G	J	J	J	J	J	J	J	J	J	J	J
100			C	C	C	G	G	G	G	J	J	J	J	J	J	J	J	J	J	J
120			C	C	C	G	G	G	G	J	J	J	J	J	J	J	J	J	J	J
150			C	C	C	G	G	G	G	J	J	J	J	J	J	J	J	J	J	J
180			C	C	C	G	G	G	G	J	J	J	J	J	J	J	J	J	J	J
220			C	C	C	G	G	G	G	J	J	J	J	J	J	J	J	J	J	M
270			C	C	C	G	G	G	G	J	J	J	J	M	J	J	J	J	J	M
330			C	C	C	G	G	G	G	J	J	J	J	M	J	J	J	J	J	M
390			C	C	C	G	G	G	G	J	J	J	J	M	J	J	J	J	J	M
470			C	C	C	G	G	G	G	J	J	J	J	M	J	J	J	J	J	M
560						G	G	G	G	J	J	J	J	M	J	J	J	J	J	M
680						G	G	G	G	J	J	J	J	M	J	J	J	J	J	P
820						G	G	G	G	J	J	J	J	M	J	J	J	J	M	
1000						G	G	G	G	J	J	J	J	M	J	J	J	J	Q	
1200										J	J	J	J		J	J	J	J	Q	
1500										J	J	J	J		J	J	J	M	Q	
1800										J	J	J	J		J	J	M	M		
2200										J	J	N			J	J	M	P		
2700										J	J	N			J	J	M	P		
3300										J	J				J	J	M	P		
3900										J	J				J	J	M	P		
4700										J	J				J	J	M	P		
5600															J	J	M			
6800															M	M				
8200															M	M				
0.010															M	M				
0.012																				
0.015																				
0.018																				
0.022																				
0.027																				
0.033																				
0.039																				
0.047																				
0.068																				
0.082																				
0.1																				
WVDC	16	25	16	25	50	16	25	50	100	16	25	50	100	200	16	25	50	100	200	500
SIZE	AU01		AU02			AU03				AU05					AU06					



\* Contact Factory

Letter	A	C	E	G	J	K	M	N	P	Q	X	Y	Z
Max. Thickness	0.33 (0.013)	0.56 (0.022)	0.71 (0.028)	0.90 (0.035)	0.94 (0.037)	1.02 (0.040)	1.27 (0.050)	1.40 (0.055)	1.52 (0.060)	1.78 (0.070)	2.29 (0.090)	2.54 (0.100)	2.79 (0.110)
	PAPER					EMBOSSSED							

# MLCC Gold Termination – AU Series

Capacitance Range (NP0 Dielectric)



## PREFERRED SIZES ARE SHADED

SIZE	AU10					AU12					AU13			AU14		
Soldering	Reflow/Epoxy/ Wire Bond*					Reflow/Epoxy/ Wire Bond*					Reflow/Epoxy/ Wire Bond*			Reflow/Epoxy/ Wire Bond*		
Packaging	Paper/Embossed					All Embossed					All Embossed			All Embossed		
(L) Length	3.20 ± 0.20 (0.126 ± 0.008)					4.50 ± 0.30 (0.177 ± 0.012)					4.50 ± 0.30 (0.177 ± 0.012)			5.72 ± 0.25 (0.225 ± 0.010)		
(W) Width	2.50 ± 0.20 (0.098 ± 0.008)					3.20 ± 0.20 (0.126 ± 0.008)					6.40 ± 0.40 (0.252 ± 0.016)			6.35 ± 0.25 (0.250 ± 0.010)		
(t) Terminal	0.50 ± 0.25 (0.020 ± 0.010)					0.61 ± 0.36 (0.024 ± 0.014)					0.61 ± 0.36 (0.024 ± 0.014)			0.64 ± 0.39 (0.025 ± 0.015)		
Cap (pF)	25	50	100	200	500	25	50	100	200	500	50	100	200	50	100	200
0.5																
1.0																
1.2																
1.5																
1.8																
2.2																
2.7																
3.3																
3.9																
4.7																
5.6																
6.8																
8.2																
10					J											
12					J											
15					J											
18					J											
22					J											
27					J											
33					J											
39					J											
47					J											
56					J											
68					J											
82					J											
100					J											
120					J											
150					J											
180					J											
220					J											
270					J											
330					J											
390					M											
470					M											
560	J	J	J	J	M											
680	J	J	J	J	M											
820	J	J	J	J	M											
1000	J	J	J	J	M	K	K	K	K	M	M	M	M	M	M	P
1200	J	J	J	M	M	K	K	K	K	M	M	M	M	M	M	P
1500	J	J	J	M	M	K	K	K	K	M	M	M	M	M	M	P
1800	J	J	J	M		K	K	K	K	M	M	M	M	M	M	P
2200	J	J	J	Q		K	K	K	K	P	M	M	M	M	M	P
2700	J	J	J	Q		K	K	K	K	P	M	M	M	M	M	P
3300	J	J	J			K	K	K	P	Q	M	M	M	M	M	P
3900	J	J	M			K	K	K	P	Q	M	M	M	M	M	P
4700	J	J	M			K	K	K	P	Q	M	M	M	M	M	P
5600	J	J				K	K	M	P	X	M	M	M	M	M	P
6800	J	J				K	K	M	X		M	M	M	M	M	P
8200	J	J				K	M	M			M	M	M	M	M	P
0.010	J	J				K	M	M			M	M		M	M	P
0.012	J	J				K	M	M			M	M		M	M	P
0.015						M	M				M	M		M	M	Y
0.018						M	M				P	M		M	M	Y
0.022						M	M				P			M	Y	Y
0.027						M	M				P			P	Y	Y
0.033						M	M				P			P		
0.039						M	M				P			P		
0.047						M	M				P			P		
0.068						M	M							P		
0.082						M	M							Q		
0.1						M	M							Q		



\* Contact Factory

Letter	A	C	E	G	J	K	M	N	P	Q	X	Y	Z
Max. Thickness	0.33 (0.013)	0.56 (0.022)	0.71 (0.028)	0.90 (0.035)	0.94 (0.037)	1.02 (0.040)	1.27 (0.050)	1.40 (0.055)	1.52 (0.060)	1.78 (0.070)	2.29 (0.090)	2.54 (0.100)	2.79 (0.110)
	PAPER					EMBOSSED							



# MLCC Gold Termination – AU Series



## Capacitance Range (NP0 Dielectric)

PREFERRED SIZES ARE SHADED

SIZE	AU02				AU03				AU05				AU06														
Soldering	Reflow/Epoxy/ Wire Bond*				Reflow/Epoxy/ Wire Bond*				Reflow/Epoxy/ Wire Bond*				Reflow/Epoxy/ Wire Bond*														
Packaging	All Paper				All Paper				Paper/Embossed				Paper/Embossed														
(L) Length	mm (in.)	1.00 ± 0.10 (0.040 ± 0.004)			1.60 ± 0.15 (0.063 ± 0.006)				2.01 ± 0.20 (0.079 ± 0.008)				3.20 ± 0.20 (0.126 ± 0.008)														
(W) Width	mm (in.)	0.50 ± 0.10 (0.020 ± 0.004)			0.81 ± 0.15 (0.032 ± 0.006)				1.25 ± 0.20 (0.049 ± 0.008)				1.60 ± 0.20 (0.063 ± 0.008)														
(t) Terminal	mm (in.)	0.25 ± 0.15 (0.010 ± 0.006)			0.35 ± 0.15 (0.014 ± 0.006)				0.50 ± 0.25 (0.020 ± 0.010)				0.50 ± 0.25 (0.020 ± 0.010)														
WVDC		10	16	25	50	63	10	16	25	50	100	200	63	10	16	25	50	100	200	63	10	16	25	50	100	200	500
Cap (pF)	100																										
	150																										
	220				C					G																	
	330				C					G	G	G		J	J	J	J	J	J								K
470				C					G	G	G		J	J	J	J	J	J								K	
680				C					G	G	G		J	J	J	J	J	J								K	
1000				C					G	G	G		J	J	J	J	J	J								K	
1500				C					G	G	G		J	J	J	J	J	J		J	J	J	J	J	J	M	
2200				C					G	G	G		J	J	J	J	J	J		J	J	J	J	J	J	M	
3300				C	C				G	G			J	J	J	J	J	J		J	J	J	J	J	J	M	
4700				C	C				G	G			J	J	J	J	J	J		J	J	J	J	J	J	M	
6800				C	C				G	G			J	J	J	J	J	J		J	J	J	J	J	J	P	
Cap (µF)	0.010				C				G		G	G		J	J	J	J	J	J		J	J	J	J	J	J	P
	0.015				C				G	G			J	J	J	J	J	J		J	J	J	J	J	J	M	
	0.022				C	C			G	G			J	J	J	J	J	N		J	J	J	J	J	J	M	
	0.033				C				G	G			J	J	J	J	N			J	J	J	J	J	J	M	
	0.047								G	G	G			J	J	J	J	N		J	J	J	J	J	J	M	
	0.068								G	G	G			J	J	J	J	N		J	J	J	J	J	J	P	
0.10								G	G	G			J	J	J	J			J	J	J	J	J	M	P		
0.15								G	G				J	J	J	N	N		J	J	J	J	J	Q			
0.22								G	G				J	J	N	N	N		J	J	J	J	J	Q			
0.33													N	N	N	N	N			J	J	M	P	Q			
0.47													N	N	N	N	N			M	M	M	P	Q			
0.68													N	N	N	N				M	M	Q	Q	Q			
1.0									J*				N	N	N					M	M		Q	Q			
1.5																				P	Q	Q					
2.2																					P*		Q				
3.3																											
4.7																											
10																											
22																											
47																											
100																											
WVDC		10	16	25	50	63	10	16	25	50	100	200	63	10	16	25	50	100	200	63	10	16	25	50	100	200	500
SIZE		AU02				AU03				AU05				AU06													

\* Contact Factory

Letter	A	C	E	G	J	K	M	N	P	Q	X	Y	Z
Max. Thickness	0.33 (0.013)	0.56 (0.022)	0.71 (0.028)	0.90 (0.035)	0.94 (0.037)	1.02 (0.040)	1.27 (0.050)	1.40 (0.055)	1.52 (0.060)	1.78 (0.070)	2.29 (0.090)	2.54 (0.100)	2.79 (0.110)
	PAPER					EMBOSS							

# MLCC Gold Termination – AU Series

Capacitance Range (X7R Dielectric)



PREFERRED SIZES ARE SHADED

SIZE	AU10							AU12				AU13		AU14		
Soldering	Reflow/Epoxy/ Wire Bond*							Reflow/Epoxy/ Wire Bond*				Reflow/Epoxy/ Wire Bond*		Reflow/Epoxy/ Wire Bond*		
Packaging	Paper/EmbossedU							All Embossed				All Embossed		All Embossed		
(L) Length	3.20 ± 0.20 (0.126 ± 0.008)							4.50 ± 0.30 (0.177 ± 0.012)				4.50 ± 0.30 (0.177 ± 0.012)		5.72 ± 0.25 (0.225 ± 0.010)		
(W) Width	2.50 ± 0.20 (0.098 ± 0.008)							3.20 ± 0.20 (0.126 ± 0.008)				6.40 ± 0.40 (0.252 ± 0.016)		6.35 ± 0.25 (0.250 ± 0.010)		
(t) Terminal	0.50 ± 0.25 (0.020 ± 0.010)							0.61 ± 0.36 (0.024 ± 0.014)				0.61 ± 0.36 (0.024 ± 0.014)		0.64 ± 0.39 (0.025 ± 0.015)		
WVDC	10	16	25	50	100	200	500	50	100	200	500	50	100	50	100	
Cap (pF)	100															
	150															
	220															
	330															
	470															
Cap (µF)	0.010	J	J	J	J	J	J	M	K	K	K	K	M	M	M	P
	0.015	J	J	J	J	J	J	P	K	K	K	P	M	M	M	P
	0.022	J	J	J	J	J	J	Q	K	K	K	P	M	M	M	P
	0.033	J	J	J	J	J	J	Q	K	K	K	X	M	M	M	P
	0.047	J	J	J	J	J	J		K	K	K	Z	M	M	M	P
Cap (µF)	0.068	J	J	J	J	J	M		K	K	K	Z	M	M	M	P
	0.10	J	J	J	J	J	M		K	K	K	Z	M	M	M	P
	0.15	J	J	J	J	M	Z		K	K	P		M	M	M	P
	0.22	J	J	J	J	P	Z		K	K	P		M	M	M	P
	0.33	J	J	J	J	Q			K	M	X		M	M	M	P
Cap (µF)	0.47	M	M	M	M	Q			K	P			M	M	M	P
	0.68	M	M	P	X	X			M	Q			M	P	M	P
	1.0	N	N		X	Z			M	X			M	P	M	P
	1.5	N	N	Z	Z	Z			Z	Z			M		M	X
	2.2	X	X	Z	Z	Z			Z	Z					M	
Cap (µF)	3.3	X	X	Z	Z				Z							
	4.7	X	X	Z	Z				Z							
	10	Z	Z	Z												
	22															
	47															
100																
WVDC	10	16	25	50	100	200	500	50	100	200	500	50	100	50	100	
SIZE	AU10							AU12				AU13		AU14		



\* Contact Factory

Letter	A	C	E	G	J	K	M	N	P	Q	X	Y	Z
Max. Thickness	0.33 (0.013)	0.56 (0.022)	0.71 (0.028)	0.90 (0.035)	0.94 (0.037)	1.02 (0.040)	1.27 (0.050)	1.40 (0.055)	1.52 (0.060)	1.78 (0.070)	2.29 (0.090)	2.54 (0.100)	2.79 (0.110)
	PAPER					EMBOSSSED							



# MLCC Gold Termination – AU Series



## AU16/AU17/AU18

SIZE		AU16 (0306)					AU17 (0508)					AU18 (0612)				
Packaging		Embossed					Embossed					Embossed				
Length	mm	0.81 ± 0.15					1.27 ± 0.25					1.60 ± 0.25				
	(in.)	(0.032 ± 0.006)					(0.050 ± 0.010)					(0.063 ± 0.010)				
Width	mm	1.60 ± 0.15					2.00 ± 0.25					3.20 ± 0.25				
	(in.)	(0.063 ± 0.006)					(0.080 ± 0.010)					(0.126 ± 0.010)				
Cap Code	WVDC	4	6.3	10	16	25	6.3	10	16	25	50	6.3	10	16	25	50
102	Cap 0.001	A	A	A	A	A	S	S	S	S	V	S	S	S	S	V
222	(µF) .0022	A	A	A	A	A	S	S	S	S	V	S	S	S	S	V
332	0.0033	A	A	A	A	A	S	S	S	S	V	S	S	S	S	V
472	0.0047	A	A	A	A	A	S	S	S	S	V	S	S	S	S	V
682	0.0068	A	A	A	A	A	S	S	S	S	V	S	S	S	S	V
103	0.01	A	A	A	A	A	S	S	S	S	V	S	S	S	S	V
153	0.015	A	A	A	A	A	S	S	S	S	V	S	S	S	S	W
223	0.022	A	A	A	A	A	S	S	S	S	V	S	S	S	S	W
333	0.033	A	A	A	A	A	S	S	S	V	V	S	S	S	S	W
473	0.047	A	A	A	A	A	S	S	S	V	A	S	S	S	S	W
683	0.068	A	A	A	A	A	S	S	S	A	A	S	S	S	V	W
104	0.1	A	A	A	A	A	S	S	V	A	A	S	S	S	V	W
154	0.15	A	A	A	A	A	S	S	V	A	A	S	S	S	W	W
224	0.22	A	A	A	A	A	S	S	A	A	A	S	S	V	W	
334	0.33						V	V	A	A	A	S	S	V		
474	0.47						V	V	A	A	A	S	S	V		
684	0.68						A	A	A	A	A	V	V	W		
105	1	A					A	A	A	A	A	V	V	A		
155	1.5						A	A	A	A	A	W	W			
225	2.2											A	A			
335	3.3															
475	4.7															
685	6.8															
106	10															

### PHYSICAL DIMENSIONS AND PAD LAYOUT

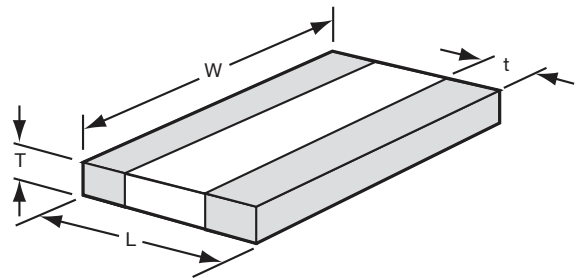

### PHYSICAL DIMENSIONS MM (IN.)

	L	W	t
<b>AU16 (0306)</b>	0.81 ± 0.15 (0.032 ± 0.006)	1.60 ± 0.15 (0.063 ± 0.006)	0.13 min. (0.005 min.)
<b>AU17 (0508)</b>	1.27 ± 0.25 (0.050 ± 0.010)	2.00 ± 0.25 (0.080 ± 0.010)	0.13 min. (0.005 min.)
<b>AU18 (0612)</b>	1.60 ± 0.25 (0.063 ± 0.010)	3.20 ± 0.25 (0.126 ± 0.010)	0.13 min. (0.005 min.)

T - See Range Chart for Thickness and Codes

### PAD LAYOUT DIMENSIONS MM (IN.)

	A	B	C
<b>AU16 (0306)</b>	0.31 (0.012)	1.52 (0.060)	0.51 (0.020)
<b>AU17 (0508)</b>	0.51 (0.020)	2.03 (0.080)	0.51 (0.020)
<b>AU18 (0612)</b>	0.76 (0.030)	3.05 (0.120)	0.635 (0.025)

Solid = X7R

= X5R

= X7S

mm (in.)	
<b>AU16 (0306)</b>	
Code	Thickness
A	0.56 (0.022)

mm (in.)	
<b>AU16 (0508)</b>	
Code	Thickness
S	0.56 (0.022)
V	0.76 (0.030)
A	1.02 (0.040)

mm (in.)	
<b>AU16 (0612)</b>	
Code	Thickness
S	0.56 (0.022)
V	0.76 (0.030)
W	1.02 (0.040)
A	1.27 (0.050)



# MLCC Tin/Lead Termination "B" (LD Series)

## C0G (NP0) – General Specifications

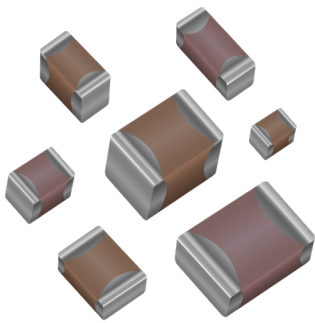

AVX Corporation will support those customers for commercial and military Multilayer Ceramic Capacitors with a termination consisting of 5% minimum lead. This termination is indicated by the use of a "B" in the 12th position of the AVX Catalog Part Number. This fulfills AVX's commitment to providing a full range of products to our customers. AVX has provided in the following pages a full range of values that we are currently offering in this special "B" termination. Please contact the factory if you require additional information on our MLCC Tin/Lead Termination "B" products.

**Not RoHS Compliant**

### PART NUMBER (SEE PAGE 4 FOR COMPLETE PART NUMBER EXPLANATION)

LD05	5	A	101	J	A	B	2	A
<b>Size</b>	<b>Voltage</b>	<b>Dielectric</b>	<b>Capacitance Code (In pF)</b>	<b>Capacitance Tolerance</b>	<b>Failure Rate</b>	<b>Terminations</b>	<b>Packaging</b>	<b>Special Code</b>
LD02 - 0402 LD03 - 0603 LD04 - 0504* LD05 - 0805 LD06 - 1206 LD10 - 1210 LD12 - 1812 LD13 - 1825 LD14 - 2225 LD20 - 2220	6.3V = 6 10V = Z 16V = Y 25V = 3 35V = D 50V = 5 100V = 1 200V = 2 500V = 7	C0G (NP0) = A X7R = C X5R = D X8R = F	2 Sig. Digits + Number of Zeros	B = ±10 pF (<10pF) C = ±25 pF (<10pF) D = ±50 pF (<10pF) F = ±1% (≥ 10 pF) G = ±2% (≥ 10 pF) J = ±5% K = ±10% M = ±20%	A = Not Applicable	B = 5% min lead X = FLEXITERM® with 5% min lead**  **X7R only	2 = 7" Reel 4 = 13" Reel  <b>Contact Factory For Multiples*</b>	A = Std. Product

\*LD04 has the same CV ranges as LD03.

See FLEXITERM® section for CV options

NOTE: Contact factory for availability of Tolerance Options for Specific Part Numbers.  
Contact factory for non-specified capacitance values.

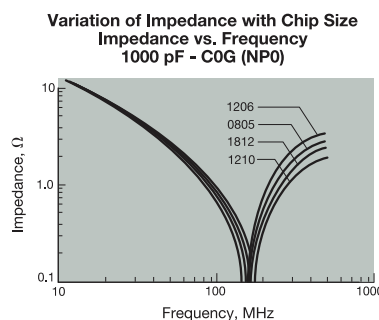
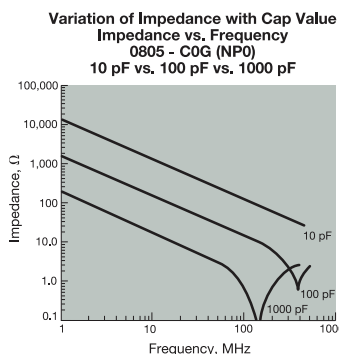
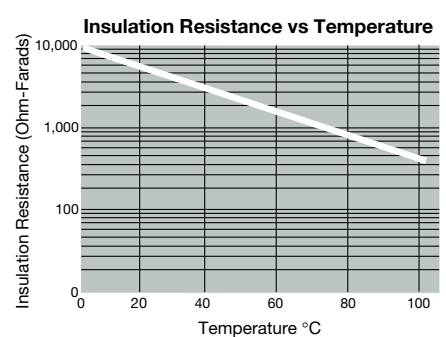
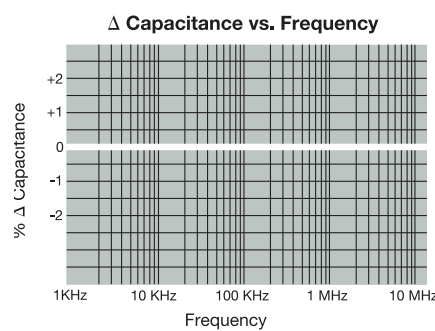
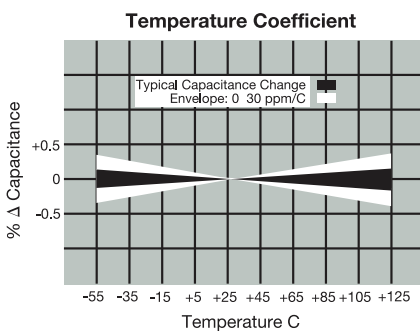

# MLCC Tin/Lead Termination "B"

## COG (NP0) – Specifications and Test Methods



Parameter/Test		NP0 Specification Limits	Measuring Conditions	
Operating Temperature Range		-55°C to +125°C	Temperature Cycle Chamber	
Capacitance		Within specified tolerance	Freq.: 1.0 MHz $\pm$ 10% for cap $\leq$ 1000 pF 1.0 kHz $\pm$ 10% for cap $>$ 1000 pF Voltage: 1.0Vrms $\pm$ .2V	
Q		$<$ 30 pF: Q $\geq$ 400+20 x Cap Value $\geq$ 30 pF: Q $\geq$ 1000		
Insulation Resistance		100,000M $\Omega$ or 1000M $\Omega$ - $\mu$ F, whichever is less	Charge device with rated voltage for 60 $\pm$ 5 secs @ room temp/humidity	
Dielectric Strength		No breakdown or visual defects	Charge device with 250% of rated voltage for 1-5 seconds, w/charge and discharge current limited to 50 mA (max) Note: Charge device with 150% of rated voltage for 500V devices.	
Resistance to Flexure Stresses	Appearance	No defects	Deflection: 2mm Test Time: 30 seconds 	
	Capacitance Variation	$\pm$ 5% or $\pm$ 5 pF, whichever is greater		
	Q	Meets Initial Values (As Above)		
	Insulation Resistance	$\geq$ Initial Value x 0.3		
Solderability		$\geq$ 95% of each terminal should be covered with fresh solder	Dip device in eutectic solder at 230 $\pm$ 5°C for 5.0 $\pm$ 0.5 seconds	
Resistance to Solder Heat	Appearance	No defects, $<$ 25% leaching of either end terminal	Dip device in eutectic solder at 260°C for 60 seconds. Store at room temperature for 24 $\pm$ 2 hours before measuring electrical properties.	
	Capacitance Variation	$\leq$ $\pm$ 2.5% or $\pm$ 25 pF, whichever is greater		
	Q	Meets Initial Values (As Above)		
	Insulation Resistance	Meets Initial Values (As Above)		
	Dielectric Strength	Meets Initial Values (As Above)		
Thermal Shock	Appearance	No visual defects	Step 1: -55°C $\pm$ 2°	30 $\pm$ 3 minutes
	Capacitance Variation	$\leq$ $\pm$ 2.5% or $\pm$ 25 pF, whichever is greater	Step 2: Room Temp	$\leq$ 3 minutes
	Q	Meets Initial Values (As Above)	Step 3: +125°C $\pm$ 2°	30 $\pm$ 3 minutes
	Insulation Resistance	Meets Initial Values (As Above)	Step 4: Room Temp	$\leq$ 3 minutes
	Dielectric Strength	Meets Initial Values (As Above)	Repeat for 5 cycles and measure after 24 hours at room temperature	
Load Life	Appearance	No visual defects	Charge device with twice rated voltage in test chamber set at 125°C $\pm$ 2°C for 1000 hours (+48, -0).  Remove from test chamber and stabilize at room temperature for 24 hours before measuring.	
	Capacitance Variation	$\leq$ $\pm$ 3.0% or $\pm$ .3 pF, whichever is greater		
	Q	$\geq$ 30 pF: Q $\geq$ 350 $\geq$ 10 pF, $<$ 30 pF: Q $\geq$ 275 +5C/2 $<$ 10 pF: Q $\geq$ 200 +10C		
	Insulation Resistance	$\geq$ Initial Value x 0.3 (See Above)		
	Dielectric Strength	Meets Initial Values (As Above)		
Load Humidity	Appearance	No visual defects	Store in a test chamber set at 85°C $\pm$ 2°C/ 85% $\pm$ 5% relative humidity for 1000 hours (+48, -0) with rated voltage applied.  Remove from chamber and stabilize at room temperature for 24 $\pm$ 2 hours before measuring.	
	Capacitance Variation	$\leq$ $\pm$ 5.0% or $\pm$ .5 pF, whichever is greater		
	Q	$\geq$ 30 pF: Q $\geq$ 350 $\geq$ 10 pF, $<$ 30 pF: Q $\geq$ 275 +5C/2 $<$ 10 pF: Q $\geq$ 200 +10C		
	Insulation Resistance	$\geq$ Initial Value x 0.3 (See Above)		
	Dielectric Strength	Meets Initial Values (As Above)		

# MLCC Tin/Lead Termination "B"

## C0G (NP0) – Capacitance Range



PREFERRED SIZES ARE SHADED

SIZE	LD02			LD03			LD05				LD06								
Soldering	Reflow/Wave			Reflow/Wave			Reflow/Wave				Reflow/Wave								
Packaging	All Paper			All Paper			Paper/Embossed				Paper/Embossed								
(L) Length	1.00 ± 0.10 (0.040 ± 0.004)			1.60 ± 0.15 (0.063 ± 0.006)			2.01 ± 0.20 (0.079 ± 0.008)				3.20 ± 0.20 (0.126 ± 0.008)								
(W) Width	0.50 ± 0.10 (0.020 ± 0.004)			0.81 ± 0.15 (0.032 ± 0.006)			1.25 ± 0.20 (0.049 ± 0.008)				1.60 ± 0.20 (0.063 ± 0.008)								
(t) Terminal	0.25 ± 0.15 (0.010 ± 0.006)			0.35 ± 0.15 (0.014 ± 0.006)			0.50 ± 0.25 (0.020 ± 0.010)				0.50 ± 0.25 (0.020 ± 0.010)								
WVDC	16	25	50	16	25	50	100	16	25	50	100	200	16	25	50	100	200	500	
Cap (pF)	0.5	C	C	C	G	G	G	G	J	J	J	J	J	J	J	J	J	J	J
	1.0	C	C	C	G	G	G	G	J	J	J	J	J	J	J	J	J	J	J
	1.2	C	C	C	G	G	G	G	J	J	J	J	J	J	J	J	J	J	J
	1.5	C	C	C	G	G	G	G	J	J	J	J	J	J	J	J	J	J	J
	1.8	C	C	C	G	G	G	G	J	J	J	J	J	J	J	J	J	J	J
	2.2	C	C	C	G	G	G	G	J	J	J	J	J	J	J	J	J	J	J
	2.7	C	C	C	G	G	G	G	J	J	J	J	J	J	J	J	J	J	J
	3.3	C	C	C	G	G	G	G	J	J	J	J	J	J	J	J	J	J	J
	3.9	C	C	C	G	G	G	G	J	J	J	J	J	J	J	J	J	J	J
	4.7	C	C	C	G	G	G	G	J	J	J	J	J	J	J	J	J	J	J
	5.6	C	C	C	G	G	G	G	J	J	J	J	J	J	J	J	J	J	J
	6.8	C	C	C	G	G	G	G	J	J	J	J	J	J	J	J	J	J	J
	8.2	C	C	C	G	G	G	G	J	J	J	J	J	J	J	J	J	J	J
	10	C	C	C	G	G	G	G	J	J	J	J	J	J	J	J	J	J	J
	12	C	C	C	G	G	G	G	J	J	J	J	J	J	J	J	J	J	J
	15	C	C	C	G	G	G	G	J	J	J	J	J	J	J	J	J	J	J
	18	C	C	C	G	G	G	G	J	J	J	J	J	J	J	J	J	J	J
	22	C	C	C	G	G	G	G	J	J	J	J	J	J	J	J	J	J	J
	27	C	C	C	G	G	G	G	J	J	J	J	J	J	J	J	J	J	J
	33	C	C	C	G	G	G	G	J	J	J	J	J	J	J	J	J	J	J
	39	C	C	C	G	G	G	G	J	J	J	J	J	J	J	J	J	J	J
	47	C	C	C	G	G	G	G	J	J	J	J	J	J	J	J	J	J	J
	56	C	C	C	G	G	G	G	J	J	J	J	J	J	J	J	J	J	J
	68	C	C	C	G	G	G	G	J	J	J	J	J	J	J	J	J	J	J
	82	C	C	C	G	G	G	G	J	J	J	J	J	J	J	J	J	J	J
	100	C	C	C	G	G	G	G	J	J	J	J	J	J	J	J	J	J	J
	120	C	C	C	G	G	G	G	J	J	J	J	J	J	J	J	J	J	J
	150	C	C	C	G	G	G	G	J	J	J	J	J	J	J	J	J	J	J
	180	C	C	C	G	G	G	G	J	J	J	J	J	J	J	J	J	J	J
	220	C	C	C	G	G	G	G	J	J	J	J	J	J	J	J	J	J	M
	270	C	C	C	G	G	G	G	J	J	J	J	M	J	J	J	J	J	M
	330	C	C	C	G	G	G	G	J	J	J	J	M	J	J	J	J	J	M
	390	C	C	C	G	G	G	G	J	J	J	J	M	J	J	J	J	J	M
	470	C	C	C	G	G	G	G	J	J	J	J	M	J	J	J	J	J	M
	560				G	G	G		J	J	J	J	M	J	J	J	J	J	M
	680				G	G	G		J	J	J	J		J	J	J	J	J	P
	820				G	G	G		J	J	J	J		J	J	J	J	M	
	1000				G	G	G		J	J	J	J		J	J	J	J	J	Q
	1200					G			J	J	J			J	J	J	J	J	Q
	1500								J	J	J			J	J	M			Q
	1800								J	J	J			J	J	M			
	2200								J	J	N			J	J	M			P
	2700								J	J	N			J	J	M			P
	3300								J	J				J	J	M			P
	3900								J	J				J	J	M			P
	4700								J	J				J	J	M			P
	5600													J	J	M			
	6800													M	M				
	8200													M	M				
Cap (pF)	0.010													M	M				
	0.012													M	M				
	0.015																		
	0.018																		
	0.022																		
	0.027																		
	0.033																		
	0.039																		
	0.047																		
	0.068																		
	0.082																		
	0.1																		
WVDC	16	25	50	16	25	50	100	16	25	50	100	200	16	25	50	100	200	500	

Letter	A	C	E	G	J	K	M	N	P	Q	X	Y	Z
Max. Thickness	0.33 (0.013)	0.56 (0.022)	0.71 (0.028)	0.90 (0.035)	0.94 (0.037)	1.02 (0.040)	1.27 (0.050)	1.40 (0.055)	1.52 (0.060)	1.78 (0.070)	2.29 (0.090)	2.54 (0.100)	2.79 (0.110)
	PAPER					EMBOSSSED							

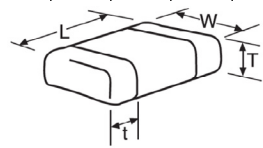

# MLCC Tin/Lead Termination "B"

C0G (NP0) – Capacitance Range



PREFERRED SIZES ARE SHADED



SIZE	LD10					LD12					LD13			LD14			
Soldering	Reflow Only					Reflow Only					Reflow Only			Reflow Only			
Packaging	Paper/Embossed					All Embossed					All Embossed			All Embossed			
(L) Length	3.20 ± 0.20 (0.126 ± 0.008)					4.50 ± 0.30 (0.177 ± 0.012)					4.50 ± 0.30 (0.177 ± 0.012)			5.72 ± 0.25 (0.225 ± 0.010)			
(W) Width	2.50 ± 0.20 (0.098 ± 0.008)					3.20 ± 0.20 (0.126 ± 0.008)					6.40 ± 0.40 (0.252 ± 0.016)			6.35 ± 0.25 (0.250 ± 0.010)			
(t) Terminal	0.50 ± 0.25 (0.020 ± 0.010)					0.61 ± 0.36 (0.024 ± 0.014)					0.61 ± 0.36 (0.024 ± 0.014)			0.64 ± 0.39 (0.025 ± 0.015)			
WVDC	25	50	100	200	500	25	50	100	200	500	50	100	200	50	100	200	
Cap (pF)	0.5																
	1.0																
	1.2																
	1.5																
	1.8																
	2.2																
	2.7																
	3.3																
	3.9																
	4.7																
	5.6																
	6.8																
	8.2																
	10				J												
	12				J												
	15				J												
	18				J												
	22				J												
	27				J												
	33				J												
	39				J												
	47				J												
	56				J												
	68				J												
	82				J												
	100				J												
	120				J												
	150				J												
	180				J												
	220				J												
	270				J												
	330				J												
	390				M												
	470				M												
	560	J	J	J	J	M											
	680	J	J	J	J	M											
	820	J	J	J	J	M											
	1000	J	J	J	J	M	K	K	K	K	M	M	M	M	M	M	P
	1200	J	J	J	J	M	K	K	K	K	M	M	M	M	M	M	P
	1500	J	J	J	M	M	K	K	K	K	M	M	M	M	M	M	P
	1800	J	J	J	M		K	K	K	K	M	M	M	M	M	M	P
	2200	J	J	J	Q		K	K	K	K	P	M	M	M	M	M	P
	2700	J	J	J	Q		K	K	K	P	Q	M	M	M	M	M	P
	3300	J	J	J			K	K	K	P	Q	M	M	M	M	M	P
	3900	J	J	M			K	K	K	P	Q	M	M	M	M	M	P
	4700	J	J	M			K	K	K	P	Q	M	M	M	M	M	P
	5600	J	J				K	K	M	P	X	M	M	M	M	M	P
	6800	J	J				K	K	M	X		M	M	M	M	M	P
	8200	J	J				K	M	M			M	M	M	M	M	P
Cap (pF)	0.010	J	J				K	M	M			M	M		M	M	P
	0.012	J	J				K	M	M			M	M		M	M	P
	0.015						M	M	M			M	M		M	M	Y
	0.018						M	M	M			P	M		M	M	Y
	0.022						M	M	M			P			M	M	Y
	0.027						M	M	M			P			P	Y	Y
	0.033						M	M	M			P			P		
	0.039						M	M	M			P			P		
	0.047						M	M	M			P			P		
	0.068						M	M	M						P		
	0.082						M	M	M						Q		
	0.1														Q		

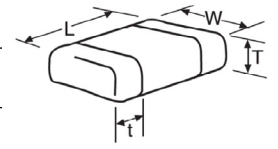

Letter	A	C	E	G	J	K	M	N	P	Q	X	Y	Z
Max. Thickness	0.33 (0.013)	0.56 (0.022)	0.71 (0.028)	0.90 (0.035)	0.94 (0.037)	1.02 (0.040)	1.27 (0.050)	1.40 (0.055)	1.52 (0.060)	1.78 (0.070)	2.29 (0.090)	2.54 (0.100)	2.79 (0.110)
	PAPER					EMBOSSSED							



# MLCC Tin/Lead Termination “B”

## X8R – General Specifications

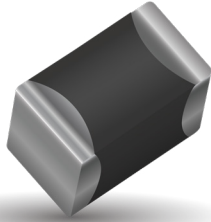

AVX Corporation will support those customers for commercial and military Multilayer Ceramic Capacitors with a termination consisting of 5% minimum lead. This termination is indicated by the use of a “B” in the 12th position of the AVX Catalog Part Number. This fulfills AVX’s commitment to providing a full range of products to our customers. AVX has provided in the following pages a full range of values that we are currently offering in this special “B” termination. Please contact the factory if you require additional information on our MLCC Tin/Lead Termination “B” products.

**Not RoHS Compliant**

### PART NUMBER (SEE PAGE 4 FOR COMPLETE PART NUMBER EXPLANATION)

LD05	5	F	101	J	A	B	2	A
<b>Size</b>	<b>Voltage</b>	<b>Dielectric</b>	<b>Capacitance Code (In pF)</b>	<b>Capacitance Tolerance</b>	<b>Failure Rate</b>	<b>Terminations</b>	<b>Packaging</b>	<b>Special Code</b>
LD02 - 0402 LD03 - 0603 LD04 - 0504* LD05 - 0805 LD06 - 1206 LD10 - 1210 LD12 - 1812 LD13 - 1825 LD14 - 2225 LD20 - 2220	6.3V = 6 10V = Z 16V = Y 25V = 3 35V = D 50V = 5 100V = 1 200V = 2 500V = 7	X8R = F	2 Sig. Digits + Number of Zeros	B = ±10 pF (<10pF) C = ±.25 pF (<10pF) D = ±.50 pF (<10pF) F = ±1% (≥ 10 pF) G = ±2% (≥ 10 pF) J = ±5% K = ±10% M = ±20%	A = Not Applicable	B = 5% min lead X = FLEXITERM® with 5% min lead**  **X7R only	2 = 7" Reel 4 = 13" Reel  <b>Contact Factory For Multiples*</b>	A = Std. Product

LD04 has the same CV ranges as LD03.

See FLEXITERM® section for CV options

NOTE: Contact factory for availability of Tolerance Options for Specific Part Numbers.  
Contact factory for non-specified capacitance values.

# MLCC Tin/Lead Termination “B”

## X8R – Specifications and Test Methods

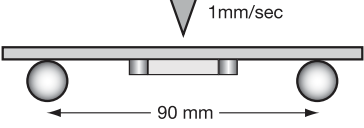

Parameter/Test		X8R Specification Limits	Measuring Conditions	
Operating Temperature Range		-55°C to +150°C	Temperature Cycle Chamber	
Capacitance		Within specified tolerance	Freq.: 1.0 kHz ± 10% Voltage: 1.0Vrms ± .2V	
Dissipation Factor		≤ 2.5% for ≥ 50V DC rating ≤ 3.5% for 25V DC and 16V DC rating		
Insulation Resistance		100,000MΩ or 1000MΩ - μF, whichever is less	Charge device with rated voltage for 120 ± 5 secs @ room temp/humidity	
Dielectric Strength		No breakdown or visual defects	Charge device with 250% of rated voltage for 1-5 seconds, w/charge and discharge current limited to 50 mA (max) Note: Charge device with 150% of rated voltage for 500V devices.	
Resistance to Flexure Stresses	Appearance	No defects	Deflection: 2mm Test Time: 30 seconds 	
	Capacitance Variation	≤ ±12%		
	Dissipation Factor	Meets Initial Values (As Above)		
	Insulation Resistance	≥ Initial Value x 0.3		
Solderability		≥ 95% of each terminal should be covered with fresh solder	Dip device in eutectic solder at 230 ± 5°C for 5.0 ± 0.5 seconds	
Resistance to Solder Heat	Appearance	No defects, <25% leaching of either end terminal	Dip device in eutectic solder at 260°C for 60 seconds. Store at room temperature for 24 ± 2 hours before measuring electrical properties.	
	Capacitance Variation	≤ ±7.5%		
	Dissipation Factor	Meets Initial Values (As Above)		
	Insulation Resistance	Meets Initial Values (As Above)		
	Dielectric Strength	Meets Initial Values (As Above)		
Thermal Shock	Appearance	No visual defects	Step 1: -55°C ± 2°	30 ± 3 minutes
	Capacitance Variation	≤ ±7.5%	Step 2: Room Temp	≤ 3 minutes
	Dissipation Factor	Meets Initial Values (As Above)	Step 3: +125°C ± 2°	30 ± 3 minutes
	Insulation Resistance	Meets Initial Values (As Above)	Step 4: Room Temp	≤ 3 minutes
	Dielectric Strength	Meets Initial Values (As Above)	Repeat for 5 cycles and measure after 24 ± 2 hours at room temperature	
Load Life	Appearance	No visual defects	Charge device with 1.5 rated voltage (≤ 10V) in test chamber set at 150°C ± 2°C for 1000 hours (+48, -0)  Remove from test chamber and stabilize at room temperature for 24 ± 2 hours before measuring.	
	Capacitance Variation	≤ ±12.5%		
	Dissipation Factor	≤ Initial Value x 2.0 (See Above)		
	Insulation Resistance	≥ Initial Value x 0.3 (See Above)		
	Dielectric Strength	Meets Initial Values (As Above)		
Load Humidity	Appearance	No visual defects	Store in a test chamber set at 85°C ± 2°C/ 85% ± 5% relative humidity for 1000 hours (+48, -0) with rated voltage applied.  Remove from chamber and stabilize at room temperature and humidity for 24 ± 2 hours before measuring.	
	Capacitance Variation	≤ ±12.5%		
	Dissipation Factor	≤ Initial Value x 2.0 (See Above)		
	Insulation Resistance	≥ Initial Value x 0.3 (See Above)		
	Dielectric Strength	Meets Initial Values (As Above)		

# MLCC Tin/Lead Termination "B"

## X8R – Capacitance Range



SIZE			LD03		LD05		LD06	
	WVDC		25V	50V	25V	50V	25V	50V
271	Cap	270	G	G				
331	(pF)	330	G	G	J	J		
471		470	G	G	J	J		
681		680	G	G	J	J		
102		1000	G	G	J	J	J	J
152		1500	G	G	J	J	J	J
182		1800	G	G	J	J	J	J
222		2200	G	G	J	J	J	J
272		2700	G	G	J	J	J	J
332		3300	G	G	J	J	J	J
392		3900	G	G	J	J	J	J
472		4700	G	G	J	J	J	J
562		5600	G	G	J	J	J	J
682		6800	G	G	J	J	J	J
822	Cap	8200	G	G	J	J	J	J
103	(µF)	0.01	G	G	J	J	J	J
123		0.012	G	G	J	J	J	J
153		0.015	G	G	J	J	J	J
183		0.018	G	G	J	J	J	J
223		0.022	G	G	J	J	J	J
273		0.027	G	G	J	J	J	J
333		0.033	G	G	J	J	J	J
393		0.039	G	G	J	J	J	J
473		0.047	G	G	J	J	J	J
563		0.056	G		N	N	M	M
683		0.068	G		N	N	M	M
823		0.082			N	N	M	M
104		0.1			N	N	M	M
124		0.12			N	N	M	M
154		0.15			N	N	M	M
184		0.18			N		M	M
224		0.22			N		M	M
274		0.27					M	M
334		0.33					M	M
394		0.39					M	
474		0.47					M	
684		0.68						
824		0.82						
105		1						
SIZE	WVDC		25V	50V	25V	50V	25V	50V
SIZE			LD03		LD05		LD06	

Letter	A	C	E	G	J	K	M	N	P	Q	X	Y	Z
Max. Thickness	0.33 (0.013)	0.56 (0.022)	0.71 (0.028)	0.90 (0.035)	0.94 (0.037)	1.02 (0.040)	1.27 (0.050)	1.40 (0.055)	1.52 (0.060)	1.78 (0.070)	2.29 (0.090)	2.54 (0.100)	2.79 (0.110)
	PAPER					EMBOSSSED							

# MLCC Tin/Lead Termination "B"

## X7R – General Specifications



AVX Corporation will support those customers for commercial and military Multilayer Ceramic Capacitors with a termination consisting of 5% minimum lead. This termination is indicated by the use of a "B" in the 12th position of the AVX Catalog Part Number. This fulfills AVX's commitment to providing a full range of products to our customers. AVX has provided in the following pages a full range of values that we are currently offering in this special "B" termination. Please contact the factory if you require additional information on our MLCC Tin/Lead Termination "B" products.

**Not RoHS Compliant**

### PART NUMBER (SEE PAGE 4 FOR COMPLETE PART NUMBER EXPLANATION)

LD05	5	C	101	J	A	B	2	A
<b>Size</b>	<b>Voltage</b>	<b>Dielectric</b>	<b>Capacitance Code (In pF)</b>	<b>Capacitance Tolerance</b>	<b>Failure Rate</b>	<b>Terminations</b>	<b>Packaging</b>	<b>Special Code</b>
LD03 - 0603 LD04 - 0504* LD05 - 0805 LD06 - 1206 LD10 - 1210 LD12 - 1812 LD13 - 1825 LD14 - 2225 LD20 - 2220	6.3V = 6 10V = Z 16V = Y 25V = 3 35V = D 50V = 5 100V = 1 200V = 2 500V = 7	X7R = C	2 Sig. Digits + Number of Zeros	B = ±10 pF (<10pF) C = ±25 pF (<10pF) D = ±50 pF (<10pF) F = ±1% (≥ 10 pF) G = ±2% (≥ 10 pF) J = ±5% K = ±10% M = ±20%	A = Not Applicable	B = 5% min lead X = FLEXITERM® with 5% min lead**  **X7R only	2 = 7" Reel 4 = 13" Reel  <b>Contact Factory For Multiples*</b>	A = Std. Product

\*LD04 has the same CV ranges as LD03.

See FLEXITERM® section for CV options

NOTE: Contact factory for availability of Tolerance Options for Specific Part Numbers.  
Contact factory for non-specified capacitance values.

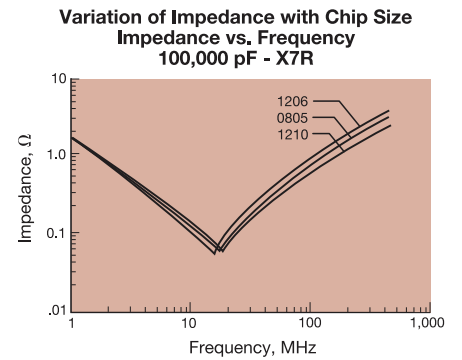
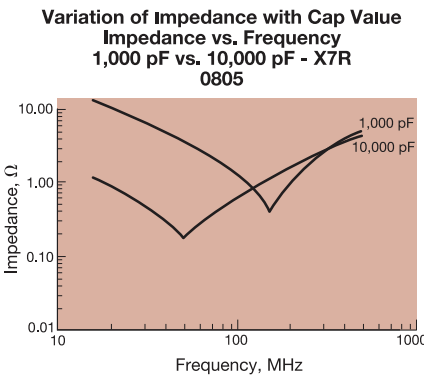
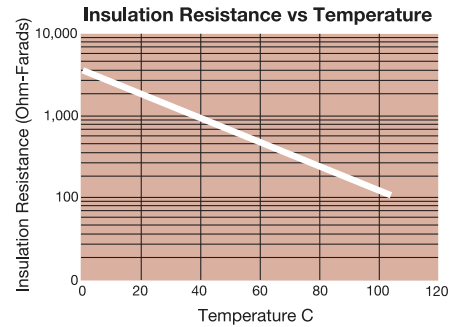
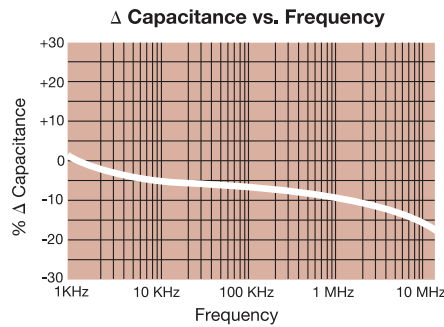

# MLCC Tin/Lead Termination "B"

## X7R – Specifications and Test Methods

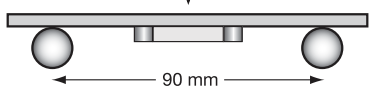

Parameter/Test		X7R Specification Limits	Measuring Conditions	
Operating Temperature Range		-55°C to +125°C	Temperature Cycle Chamber	
Capacitance		Within specified tolerance	Freq.: 1.0 kHz ± 10% Voltage: 1.0Vrms ± .2V	
Dissipation Factor		$\leq 10\%$ for $\geq 50V$ DC rating $\leq 12.5\%$ for 25V DC rating $\leq 12.5\%$ for 25V and 16V DC rating $\leq 12.5\%$ for $\leq 10V$ DC rating		
Insulation Resistance		100,000M $\Omega$ or 1000M $\Omega$ - $\mu$ F, whichever is less	Charge device with rated voltage for 120 ± 5 secs @ room temp/humidity	
Dielectric Strength		No breakdown or visual defects	Charge device with 250% of rated voltage for 1-5 seconds, w/charge and discharge current limited to 50 mA (max) Note: Charge device with 150% of rated voltage for 500V devices.	
Resistance to Flexure Stresses	Appearance	No defects	Deflection: 2mm Test Time: 30 seconds 1mm/sec 	
	Capacitance Variation	$\leq \pm 12\%$		
	Dissipation Factor	Meets Initial Values (As Above)		
	Insulation Resistance	$\geq$ Initial Value x 0.3		
Solderability		$\geq 95\%$ of each terminal should be covered with fresh solder	Dip device in eutectic solder at 230 ± 5°C for 5.0 ± 0.5 seconds	
Resistance to Solder Heat	Appearance	No defects, <25% leaching of either end terminal	Dip device in eutectic solder at 260°C for 60 seconds. Store at room temperature for 24 ± 2 hours before measuring electrical properties.	
	Capacitance Variation	$\leq \pm 7.5\%$		
	Dissipation Factor	Meets Initial Values (As Above)		
	Insulation Resistance	Meets Initial Values (As Above)		
	Dielectric Strength	Meets Initial Values (As Above)		
Thermal Shock	Appearance	No visual defects	Step 1: -55°C ± 2°	30 ± 3 minutes
	Capacitance Variation	$\leq \pm 7.5\%$	Step 2: Room Temp	$\leq 3$ minutes
	Dissipation Factor	Meets Initial Values (As Above)	Step 3: +125°C ± 2°	30 ± 3 minutes
	Insulation Resistance	Meets Initial Values (As Above)	Step 4: Room Temp	$\leq 3$ minutes
	Dielectric Strength	Meets Initial Values (As Above)	Repeat for 5 cycles and measure after 24 ± 2 hours at room temperature	
Load Life	Appearance	No visual defects	Charge device with 1.5 rated voltage ( $\leq 10V$ ) in test chamber set at 125°C ± 2°C for 1000 hours (+48, -0)  Remove from test chamber and stabilize at room temperature for 24 ± 2 hours before measuring.	
	Capacitance Variation	$\leq \pm 12.5\%$		
	Dissipation Factor	$\leq$ Initial Value x 2.0 (See Above)		
	Insulation Resistance	$\geq$ Initial Value x 0.3 (See Above)		
	Dielectric Strength	Meets Initial Values (As Above)		
Load Humidity	Appearance	No visual defects	Store in a test chamber set at 85°C ± 2°C/ 85% ± 5% relative humidity for 1000 hours (+48, -0) with rated voltage applied.  Remove from chamber and stabilize at room temperature and humidity for 24 ± 2 hours before measuring.	
	Capacitance Variation	$\leq \pm 12.5\%$		
	Dissipation Factor	$\leq$ Initial Value x 2.0 (See Above)		
	Insulation Resistance	$\geq$ Initial Value x 0.3 (See Above)		
	Dielectric Strength	Meets Initial Values (As Above)		

# MLCC Tin/Lead Termination "B"

## X7R – Capacitance Range



PREFERRED SIZES ARE SHADED

SIZE	LD02			LD03						LD05						LD06										
Soldering	Reflow/Wave			Reflow/Wave						Reflow/Wave						Reflow/Wave										
Packaging	All Paper			All Paper						Paper/Embossed						Paper/Embossed										
(L) Length	mm	1.00 ± 0.10		1.60 ± 0.15						2.01 ± 0.20						3.20 ± 0.20										
(L) Length	(in.)	(0.040 ± 0.004)		(0.063 ± 0.006)						(0.079 ± 0.008)						(0.126 ± 0.008)										
(W) Width	mm	0.50 ± 0.10		0.81 ± 0.15						1.25 ± 0.20						1.60 ± 0.20										
(W) Width	(in.)	(0.020 ± 0.004)		(0.032 ± 0.006)						(0.049 ± 0.008)						(0.063 ± 0.008)										
(t) Terminal	mm	0.25 ± 0.15		0.35 ± 0.15						0.50 ± 0.25						0.50 ± 0.25										
(t) Terminal	(in.)	(0.010 ± 0.006)		(0.014 ± 0.006)						(0.020 ± 0.010)						(0.020 ± 0.010)										
WVDC		16	25	50	6.3	10	16	25	50	100	200	6.3	10	16	25	50	100	200	6.3	10	16	25	50	100	200	500
Cap (pF)	100																									
	150																									
	220			C																						
	330			C					G	G	G		J	J	J	J	J	J								K
	470			C					G	G	G		J	J	J	J	J	J								K
	680			C					G	G	G		J	J	J	J	J	J								K
	1000			C					G	G	G		J	J	J	J	J	J								K
	1500			C					G	G	G		J	J	J	J	J	J		J	J	J	J	J	J	M
	2200			C					G	G	G		J	J	J	J	J	J		J	J	J	J	J	J	M
	3300		C	C					G	G	G		J	J	J	J	J	J		J	J	J	J	J	J	M
	4700		C	C					G	G	G		J	J	J	J	J	J		J	J	J	J	J	J	M
	6800	C	C						G	G	G		J	J	J	J	J	J		J	J	J	J	J	J	P
Cap (µF)	0.010	C	C						G	G			J	J	J	J	J	J		J	J	J	J	J	J	P
	0.015	C							G	G			J	J	J	J	J	J		J	J	J	J	J	J	M
	0.022	C							G	G			J	J	J	J	J	N		J	J	J	J	J	J	M
	0.033	C							G	G			J	J	J	J	N			J	J	J	J	J	J	M
	0.047								G	G	G		J	J	J	J	N			J	J	J	J	J	J	M
	0.068								G	G	G		J	J	J	J	N			J	J	J	J	J	J	P
	0.10		C*						G	G	G		J	J	J	J	N			J	J	J	J	J	J	P
	0.15								G	G			J	J	J	J	N			J	J	J	J	J	J	Q
	0.22								G	G			J	J	N	N	N			J	J	J	J	J	J	Q
	0.33												N	N	N	N	N			J	J	M	P	Q	Q	
	0.47								J*				N	N	N	N	N			M	M	M	P	Q	Q	
	0.68												N	N	N					M	M	Q	Q	Q	Q	
	1.0								J*	J*			N	N	N*					M	M	Q	Q	Q		
	1.5																			P	Q	Q				
	2.2								J*											Q	Q	Q				
	3.3																									
	4.7																									
	10																									
	22																									
	47																									
	100																									
WVDC		16	25	50	6.3	10	16	25	50	100	200	6.3	10	16	25	50	100	200	6.3	10	16	25	50	100	200	500
SIZE	LD02			LD03						LD05						LD06										

Letter	A	C	E	G	J	K	M	N	P	Q	X	Y	Z
Max. Thickness	0.33 (0.013)	0.56 (0.022)	0.71 (0.028)	0.90 (0.035)	0.94 (0.037)	1.02 (0.040)	1.27 (0.050)	1.40 (0.055)	1.52 (0.060)	1.78 (0.070)	2.29 (0.090)	2.54 (0.100)	2.79 (0.110)
	PAPER					EMBOSSSED							

= Under Development

# MLCC Tin/Lead Termination "B"

## X7R – Capacitance Range



PREFERRED SIZES ARE SHADED

SIZE	LD10							LD12				LD13		LD20				LD14		
	10	16	25	50	100	200	500	50	100	200	500	50	100	25	50	100	200	50	100	
<b>Soldering</b>	Reflow Only							Reflow Only				Reflow Only		Reflow Only				Reflow Only		
<b>Packaging</b>	Paper/Embossed							All Embossed				All Embossed		All Embossed				All Embossed		
(L) Length	3.20 ± 0.20 (0.126 ± 0.008)							4.50 ± 0.30 (0.177 ± 0.012)				4.50 ± 0.30 (0.177 ± 0.012)		5.70 ± 0.40 (0.225 ± 0.016)				5.72 ± 0.25 (0.225 ± 0.010)		
(W) Width	2.50 ± 0.20 (0.098 ± 0.008)							3.20 ± 0.20 (0.126 ± 0.008)				6.40 ± 0.40 (0.252 ± 0.016)		5.00 ± 0.40 (0.197 ± 0.016)				6.35 ± 0.25 (0.250 ± 0.010)		
(t) Terminal	0.50 ± 0.25 (0.020 ± 0.010)							0.61 ± 0.36 (0.024 ± 0.014)				0.61 ± 0.36 (0.024 ± 0.014)		0.64 ± 0.39 (0.025 ± 0.015)				0.64 ± 0.39 (0.025 ± 0.015)		
WVDC	10	16	25	50	100	200	500	50	100	200	500	50	100	25	50	100	200	50	100	
Cap (pF)	100																			
	150																			
	220																			
	330																			
	470																			
	680																			
	1000																			
	1500	J	J	J	J	J	J	M												
	2200	J	J	J	J	J	J	M												
	3300	J	J	J	J	J	J	M												
	4700	J	J	J	J	J	J	M												
	6800	J	J	J	J	J	J	M												
Cap (µF)	0.010	J	J	J	J	J	M	K	K	K	K	M	M		X	X	X	M	P	
	0.015	J	J	J	J	J	P	K	K	K	P	M	M		X	X	X	M	P	
	0.022	J	J	J	J	J	Q	K	K	K	Z	M	M		X	X	X	M	P	
	0.033	J	J	J	J	J	Q	K	K	K	X	M	M		X	X	X	M	P	
	0.047	J	J	J	J	J	J	K	K	K	Z	M	M		X	X	X	M	P	
	0.068	J	J	J	J	J	M	K	K	K	Z	M	M		X	X	X	M	P	
	0.10	J	J	J	J	J	M	K	K	K	Z	M	M		X	X	X	M	P	
	0.15	J	J	J	J	M	Z	K	K	P		M	M		X	X	X	M	P	
	0.22	J	J	J	J	P	Z	K	K	P		M	M		X	X	X	M	P	
	0.33	J	J	J	J	Q		K	M	X		M	M		X	X	X	M	P	
	0.47	M	M	M	M	Q		K	P			M	M		X	X	X	M	P	
	0.68	M	M	P	X	X		M	Q			M	P		X	X		M	P	
	1.0	N	N	P	X	Z		M	X			M	P		X	X		M	P	
	1.5	N	N	Z	Z	Z		Z	Z			M			X	X		M	X	
	2.2	X	X	Z	Z	Z		Z	Z						X	X		M		
	3.3	X	X	Z	Z			Z							X	Z				
	4.7	X	X	Z	Z										X	Z				
	10	Z	Z	Z	Z										Z	Z				
	22	Z	Z											Z						
	47																			
	100																			
WVDC	10	16	25	50	100	200	500	50	100	200	500	50	100	25	50	100	200	50	100	



Letter	A	C	E	G	J	K	M	N	P	Q	X	Y	Z
Max. Thickness	0.33 (0.013)	0.56 (0.022)	0.71 (0.028)	0.90 (0.035)	0.94 (0.037)	1.02 (0.040)	1.27 (0.050)	1.40 (0.055)	1.52 (0.060)	1.78 (0.070)	2.29 (0.090)	2.54 (0.100)	2.79 (0.110)
	PAPER					EMBOSSED							

# MLCC Tin/Lead Termination "B"

## X5R – General Specifications



AVX Corporation will support those customers for commercial and military Multilayer Ceramic Capacitors with a termination consisting of 5% minimum lead. This termination is indicated by the use of a "B" in the 12th position of the AVX Catalog Part Number. This fulfills AVX's commitment to providing a full range of products to our customers. AVX has provided in the following pages a full range of values that we are currently offering in this special "B" termination. Please contact the factory if you require additional information on our MLCC Tin/Lead Termination "B" products.

**Not RoHS Compliant**

### PART NUMBER (SEE PAGE 4 FOR COMPLETE PART NUMBER EXPLANATION)

LD05	5	D	101	J	A	B	2	A
<b>Size</b>	<b>Voltage</b>	<b>Dielectric</b>	<b>Capacitance Code (In pF)</b>	<b>Capacitance Tolerance</b>	<b>Failure Rate</b>	<b>Terminations</b>	<b>Packaging</b>	<b>Special Code</b>
LD02 - 0402 LD03 - 0603 LD04 - 0504* LD05 - 0805 LD06 - 1206 LD10 - 1210 LD12 - 1812 LD13 - 1825 LD14 - 2225 LD20 - 2220	6.3V = 6 10V = Z 16V = Y 25V = 3 35V = D 50V = 5 100V = 1 200V = 2 500V = 7	X5R = D	2 Sig. Digits + Number of Zeros	B = ±10 pF (<10pF) C = ±25 pF (<10pF) D = ±50 pF (<10pF) F = ±1% (≥ 10 pF) G = ±2% (≥ 10 pF) J = ±5% K = ±10% M = ±20%	A = Not Applicable	B = 5% min lead X = FLEXITERM® with 5% min lead**  **X7R only	2 = 7" Reel 4 = 13" Reel  <b>Contact Factory For Multiples*</b>	A = Std. Product

\*LD04 has the same CV ranges as LD03.

See FLEXITERM® section for CV options

NOTE: Contact factory for availability of Tolerance Options for Specific Part Numbers.  
Contact factory for non-specified capacitance values.

### TYPICAL ELECTRICAL CHARACTERISTICS

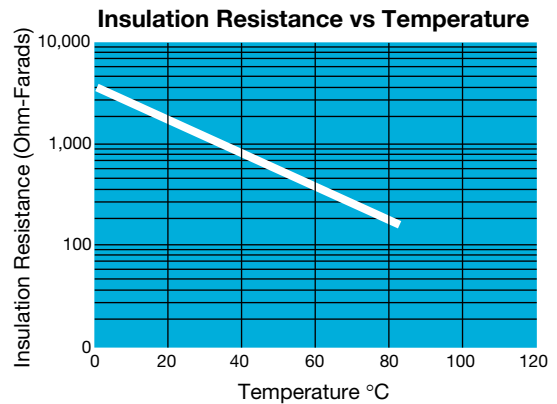
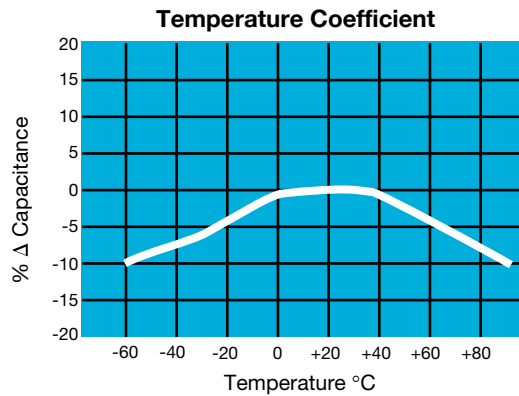

# MLCC Tin/Lead Termination "B"

## X5R – Specifications and Test Methods

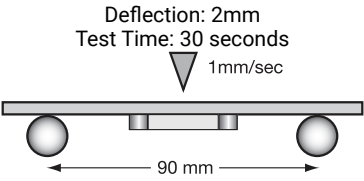

Parameter/Test		X5R Specification Limits	Measuring Conditions	
Operating Temperature Range		-55°C to +85°C	Temperature Cycle Chamber	
Capacitance		Within specified tolerance		
Dissipation Factor		$\leq 2.5\%$ for $\geq 50V$ DC rating $\leq 3.0\%$ for 25V, 35V DC rating $\leq 12.5\%$ Max. for 16V DC rating and lower Contact Factory for DF by PN	Freq.: 1.0 kHz $\pm 10\%$ Voltage: 1.0Vrms $\pm .2V$ For Cap > 10 $\mu F$ , 0.5Vrms @ 120Hz	
Insulation Resistance		10,000M $\Omega$ or 500M $\Omega$ - $\mu F$ , whichever is less	Charge device with rated voltage for 120 $\pm 5$ secs @ room temp/humidity	
Dielectric Strength		No breakdown or visual defects	Charge device with 250% of rated voltage for 1-5 seconds, w/charge and discharge current limited to 50 mA (max)	
Resistance to Flexure Stresses	Appearance	No defects	Deflection: 2mm Test Time: 30 seconds  1mm/sec 90 mm	
	Capacitance Variation	$\leq \pm 12\%$		
	Dissipation Factor	Meets Initial Values (As Above)		
	Insulation Resistance	$\geq$ Initial Value x 0.3		
Solderability		$\geq 95\%$ of each terminal should be covered with fresh solder	Dip device in eutectic solder at 230 $\pm 5^\circ C$ for 5.0 $\pm 0.5$ seconds	
Resistance to Solder Heat	Appearance	No defects, <25% leaching of either end terminal	Dip device in eutectic solder at 260°C for 60 seconds. Store at room temperature for 24 $\pm 2$ hours before measuring electrical properties.	
	Capacitance Variation	$\leq \pm 7.5\%$		
	Dissipation Factor	Meets Initial Values (As Above)		
	Insulation Resistance	Meets Initial Values (As Above)		
	Dielectric Strength	Meets Initial Values (As Above)		
Thermal Shock	Appearance	No visual defects	Step 1: -55°C $\pm 2^\circ$	30 $\pm 3$ minutes
	Capacitance Variation	$\leq \pm 7.5\%$	Step 2: Room Temp	$\leq 3$ minutes
	Dissipation Factor	Meets Initial Values (As Above)	Step 3: +85°C $\pm 2^\circ$	30 $\pm 3$ minutes
	Insulation Resistance	Meets Initial Values (As Above)	Step 4: Room Temp	$\leq 3$ minutes
	Dielectric Strength	Meets Initial Values (As Above)	Repeat for 5 cycles and measure after 24 $\pm 2$ hours at room temperature	
Load Life	Appearance	No visual defects	Charge device with 1.5X rated voltage in test chamber set at 85°C $\pm 2^\circ C$ for 1000 hours (+48, -0). Note: Contact factory for *optional specification part numbers that are tested at < 1.5X rated voltage.  Remove from test chamber and stabilize at room temperature for 24 $\pm 2$ hours before measuring.	
	Capacitance Variation	$\leq \pm 12.5\%$		
	Dissipation Factor	$\leq$ Initial Value x 2.0 (See Above)		
	Insulation Resistance	$\geq$ Initial Value x 0.3 (See Above)		
	Dielectric Strength	Meets Initial Values (As Above)		
Load Humidity	Appearance	No visual defects	Store in a test chamber set at 85°C $\pm 2^\circ C$ / 85% $\pm 5\%$ relative humidity for 1000 hours (+48, -0) with rated voltage applied.  Remove from chamber and stabilize at room temperature and humidity for 24 $\pm 2$ hours before measuring.	
	Capacitance Variation	$\leq \pm 12.5\%$		
	Dissipation Factor	$\leq$ Initial Value x 2.0 (See Above)		
	Insulation Resistance	$\geq$ Initial Value x 0.3 (See Above)		
	Dielectric Strength	Meets Initial Values (As Above)		

# MLCC Tin/Lead Termination "B"

## X5R – Capacitance Range



### PREFERRED SIZES ARE SHADED

SIZE	LD02					LD03					LD05					LD06					LD10					LD12												
Soldering	Reflow/Wave																																					
Packaging	All Paper										Paper/Embossed																											
(L) Length	1.00 ± 0.10 (0.040 ± 0.004)					1.60 ± 0.15 (0.063 ± 0.006)					2.01 ± 0.20 (0.079 ± 0.008)					3.20 ± 0.20 (0.126 ± 0.008)					3.20 ± 0.20 (0.126 ± 0.008)																	
(W) Width	0.50 ± 0.10 (0.020 ± 0.004)					0.81 ± 0.15 (0.032 ± 0.006)					1.25 ± 0.20 (0.049 ± 0.008)					1.60 ± 0.20 (0.063 ± 0.008)					2.50 ± 0.20 (0.098 ± 0.008)																	
(t) Terminal	0.25 ± 0.15 (0.010 ± 0.006)					0.35 ± 0.15 (0.014 ± 0.006)					0.50 ± 0.25 (0.020 ± 0.010)					0.50 ± 0.25 (0.020 ± 0.010)					0.50 ± 0.25 (0.020 ± 0.010)																	
WVDC	4	6.3	10	16	25	50	4	6.3	10	16	25	35	50	6.3	10	16	25	35	50	6.3	10	16	25	35	50	4	6.3	10	16	25	35	50	6.3	10	25	50		
Cap (pF)						C																																
						C																																
						C																																
						C																																
						C																																
						C																																
						C																																
						C																																
						C																																
						C																																
						C																																
						C																																
						C																																
						C																																
						C																																
						C																																
						C																																
						C																																
						C																																
						C																																
						C																																
						C																																
						C																																
						C																																
						C																																
						C																																
						C																																
						C																																
						C																																
						C																																
						C																																
						C																																
						C																																
						C																																
						C																																
						C																																
						C																																
						C																																
						C																																
						C																																
						C																																
						C																																
						C																																
						C																																
						C																																
						C																																
						C																																
						C																																
						C																																
						C																																
						C																																
						C																																
						C																																
						C																																
						C																																
						C																																
						C																																
						C																																
						C																																
						C																																
						C																																
						C																																
						C																																
						C																																
						C																																
						C																																

# Automotive MLCC

## General Specifications



### GENERAL DESCRIPTION

AVX Corporation has supported the Automotive Industry requirements for Multilayer Ceramic Capacitors consistently for more than 10 years. Products have been developed and tested specifically for automotive applications and all manufacturing facilities are QS9000 and VDA 6.4 approved.

As part of our sustained investment in capacity and state of the art technology, we are now transitioning from the established Pd/Ag electrode system to a Base Metal Electrode system (BME).

AVX is using AECQ200 as the qualification vehicle for this transition. A detailed qualification package is available on request and contains results on a range of part numbers including:

- X7R dielectric components containing BME electrode and copper terminations with a Ni/Sn plated overcoat
- X7R dielectric components, BME electrode with epoxy finish for conductive glue mounting

### HOW TO ORDER

**0805**

**Size**  
0402  
0603  
0805  
1206  
1210  
1812

**5**

**Voltage**  
6.3V = 6  
10V = Z  
16V = Y  
25V = 3  
35V = D  
50V = 5  
100V = 1  
200V = 2  
500V = 7

**A**

**Dielectric**  
NP0 = A  
X7R = C  
X8R = F

**104**

**Capacitance Code (In pF)**  
2 Sig. Digits + Number of Zeros  
e.g. 10 F = 106

**K**

**Capacitance Tolerance**  
F =  $\pm 1\%$  ( $\geq 10\text{pF}$ )\*  
G =  $\pm 2\%$  ( $\geq 10\text{pF}$ )\*  
J =  $\pm 5\%$  ( $\leq 1\mu\text{F}$ )  
K =  $\pm 10\%$   
M =  $\pm 20\%$

\*NPO only

**4**

**Failure Rate**  
4=Automotive

**T**

**Terminations**  
T = Plated Ni and Sn  
Z = FLEXITERM®\*\*  
U = Conductive Epo  
  
\*\*X7R X8R only

**2**

**Packaging**  
2 = 7" Reel  
4 = 13" Reel

**A**

**Special Code**  
A = Std.Product

Contact factory for availability of Tolerance Options for Specific Part Numbers.

NOTE: Contact factory for non-specified capacitance values  
0402 case size available in T termination only.

### COMMERCIAL VS AUTOMOTIVE MLCC PROCESS COMPARISON

	Commercial	Automotive
Administrative	Standard Part Numbers. No restriction on who purchases these parts.	Specific Automotive Part Number. Used to control supply of product to Automotive customers.
Design	Minimum ceramic thickness of 0.020"	Minimum Ceramic thickness of 0.029" (0.74mm) on all X7R product.
Dicing	Side & End Margins = 0.003" min	Side & End Margins = 0.004" min Cover Layers = 0.003" min
Lot Qualification (Destructive Physical Analysis - DPA)	As per EIA RS469	Increased sample plan stricter criteria.
Visual/Cosmetic Quality	Standard process and inspection	100% inspection
Application Robustness	Standard sampling for accelerated wave solder on X7R dielectrics	Increased sampling for accelerated wave solder on X7R and NP0 followed by lot by lot reliability testing.

All Tests have Accept/Reject Criteria 0/1

# Automotive MLCC

## NP0/X7R Dielectric



### FLEXITERM FEATURES

a) Bend Test

The capacitor is soldered to the PC Board as shown:

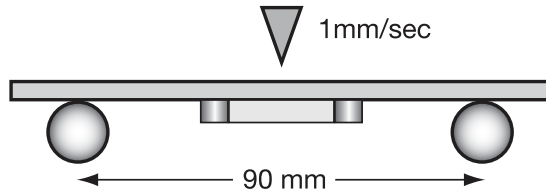

Typical bend test results are shown below:

Style	Conventional	Soft Term
0603	>2mm	>5
0805	>2mm	>5
1206	>2mm	>5

a) Temperature Cycle testing

FLEXITERM® has the ability to withstand at least 1000 cycles between -55°C and +125°C

# Automotive MLCC-NP0

## Capacitance Range



SIZE	0402		0603				0805					1206					
Soldering	Reflow/Wave		Reflow/Wave				Reflow/Wave					Reflow/Wave					
WVDC	25V	50V	25V	50V	100V	200V	25V	50V	100V	200V	250V	25V	50V	100V	200V	250V	500V
100	10pF	C	C	G	G	G	G	J	J	J	N	N	J	J	J	J	J
120	12	C	C	G	G	G	G	J	J	J	N	N	J	J	J	J	J
150	15	C	C	G	G	G	G	J	J	J	N	N	J	J	J	J	J
180	18	C	C	G	G	G	G	J	J	J	N	N	J	J	J	J	J
220	22	C	C	G	G	G	G	J	J	J	N	N	J	J	J	J	J
270	27	C	C	G	G	G	G	J	J	J	N	N	J	J	J	J	J
330	33	C	C	G	G	G	G	J	J	J	N	N	J	J	J	J	J
390	39	C	C	G	G	G	G	J	J	J	N	N	J	J	J	J	J
470	47			G	G	G	G	J	J	J	N	N	J	J	J	J	J
510	51			G	G	G	G	J	J	J	N	N	J	J	J	J	J
560	56			G	G	G	G	J	J	J	N	N	J	J	J	J	J
680	68			G	G	G	G	J	J	J	N	N	J	J	J	J	J
820	82			G	G	G	G	J	J	J	N	N	J	J	J	J	J
101	100			G	G	G	G	J	J	J	N	N	J	J	J	J	J
121	120			G	G	G	G	J	J	J	N	N	J	J	J	J	J
151	150			G	G	G	G	J	J	J	N	N	J	J	J	J	J
181	180			G	G	G	G	J	J	J	N	N	J	J	J	J	J
221	220			G	G	G	G	J	J	J	N	N	J	J	J	J	J
271	270			G	G	G	G	J	J	J	N	N	J	J	J	J	J
331	330			G	G	G	G	J	J	J	N	N	J	J	J	J	J
391	390			G	G			J	J	J			J	J	J	J	J
471	470			G	G			J	J	J			J	J	J	J	J
561	560			G	G			J	J	J			J	J	J	J	J
681	680			G	G			J	J	J			J	J	J	J	J
821	820							J	J	J			J	J	J	J	J
102	1000							J	J	J			J	J	J	J	J
122	1200																
152	1500																
182	1800																
222	2200																
272	2700																
332	3300																
392	3900																
472	4700																
103	10nF																
WVDC	25V	50V	25V	50V	100V	200V	25V	50V	100V	200V	250V	25V	50V	100V	200V	250V	500V
Size	0402		0603				0805					1206					

Letter	A	C	E	G	J	K	M	N	P	Q	X	Y	Z
Max. Thickness	0.33 (0.013)	0.56 (0.022)	0.71 (0.028)	0.90 (0.035)	0.94 (0.037)	1.02 (0.040)	1.27 (0.050)	1.40 (0.055)	1.52 (0.060)	1.78 (0.070)	2.29 (0.090)	2.54 (0.100)	2.79 (0.110)
	PAPER					EMBOSSED							

# Automotive MLCC - X7R

## Capacitance Range



SIZE	0402			0603						0805						1206						1210				1812		2220						
	Reflow/Wave			Reflow/Wave						Reflow/Wave						Reflow/Wave						Reflow Only				Reflow Only		Reflow Only						
WVDC	16V	25V	50V	10V	16V	25V	50V	100V	200V	250V	16V	25V	50V	100V	200V	250V	16V	25V	50V	100V	200V	250V	500V	16V	25V	50V	100V	50V	100V	25V	50V	100V		
221	Cap 220	C	C	C										C																				
271	(pF) 270	C	C	C																														
331	330	C	C	C																														
391	390	C	C	C																														
471	470	C	C	C																														
561	560	C	C	C																														
681	680	C	C	C																														
821	820	C	C	C																														
102	1000	C	C	C	G	G	G	G	G	G	J	J	J	J	J	J	J	J	J	J	J	J	J	J	K	K	K	K	K	K	K	K		
182	1800	C	C	C	G	G	G	G	G	G	J	J	J	J	J	J	J	J	J	J	J	J	J	J	K	K	K	K	K	K	K	K		
222	2200	C	C	C	G	G	G	G	G	G	J	J	J	J	J	J	J	J	J	J	J	J	J	J	K	K	K	K	K	K	K	K		
332	3300	C	C	C	G	G	G	G	G	G	J	J	J	J	J	J	J	J	J	J	J	J	J	J	K	K	K	K	K	K	K	K		
472	4700	C	C	C	G	G	G	G	G	G	J	J	J	J	J	J	J	J	J	J	J	J	J	J	K	K	K	K	K	K	K	K		
103	Cap 0.01	C			G	G	G	G	G	G	J	J	J	J	J	J	J	J	J	J	J	J	J	J	K	K	K	K	K	K	K	K		
123	(F) 0.012	C			G	G	G	G	G		J	J	J	N	N	N	J	J	J	J	J	J	J	J	K	K	K	K	K	K	K	K		
153	0.015	C			G	G	G	G	G		J	J	J	N	N	N	J	J	J	J	J	J	J	J	K	K	K	K	K	K	K	K		
183	0.018	C			G	G	G	G	G		J	J	J	N	N	N	J	J	J	J	J	J	J	J	K	K	K	K	K	K	K	K		
223	0.022	C			G	G	G	G	G		J	J	J	N	N	N	J	J	J	J	J	J	J	J	K	K	K	K	K	K	K	K		
273	0.027	C			G	G	G	G			J	J	J	N	N	N	J	J	J	J	J	J	J	J	K	K	K	K	K	K	K	K		
333	0.033	C			G	G	G	G			J	J	J	N	N	N	J	J	J	J	J	J	J	J	K	K	K	K	K	K	K	K		
473	0.047				G	G	G	G			J	J	J	N	N	N	J	J	J	M	M	M	M	M	K	K	K	K	K	K	K	K		
563	0.056				G	G	G	G			J	J	J	N			J	J	J	M	M	M	M	K	K	K	M	K	K					
683	0.068				G	G	G	G			J	J	J	N			J	J	J	M	M	M	M	K	K	K	M	K	K					
823	0.082				G	G	G	G			J	J	J	N			J	J	J	M	M	M	M	K	K	K	M	K	K					
104	0.1				G	G	G	G			J	J	M	N			J	J	J	M	P	P	P	K	K	K	M	K	K					
124	0.12				G						J	J	N	N			J	J	M	M	Q	Q	Q	K	K	K	P	K	K					
154	0.15				G						M	N	N	N			J	J	M	M	Q	Q	Q	K	K	K	P	K	K					
224	0.22				G						M	N	N	N			J	M	M	Q	Q	Q	Q	M	M	M	P	M	M					
334	0.33										N	N	N	N			J	M	P	Q				P	P	P	Q	X	X					
474	0.47										N	N	N	N			M	M	P	Q				P	P	P	Q	X	X					
684	0.68										N	N	N				M	Q	Q	Q				P	P	Q	X	X	X					
105	1										N	N	N				M	Q	Q	Q				P	Q	Q	X	X	X		Z	Z		
155	1.5																Q	Q	Q	Q				P	Q	Z	Z	X	X		Z	Z		
225	2.2																Q	Q	Q	Q				X	Z	Z	Z	Z	Z		Z	Z		
335	3.3																Q	Q	Q	Q				X	Z	Z	Z	Z		Z	Z			
475	4.7																Q	Q	Q					X	Z	Z	Z	Z		Z	Z			
106	10																							Z	Z	Z		Z		Z	Z			
226	22																								Z	Z	Z		Z		Z	Z		
WVDC	16V	25V	50V	10V	16V	25V	50V	100V	200V	250V	16V	25V	50V	100V	200V	250V	16V	25V	50V	100V	200V	250V	500V	16V	25V	50V	100V	50V	100V	25V	50V	100V		
Size	0402			0603						0805						1206						1210				1812		2220						

Letter	A	C	E	G	J	K	M	N	P	Q	X	Y	Z
Max. Thickness	0.33 (0.013)	0.56 (0.022)	0.71 (0.028)	0.90 (0.035)	0.94 (0.037)	1.02 (0.040)	1.27 (0.050)	1.40 (0.055)	1.52 (0.060)	1.78 (0.070)	2.29 (0.090)	2.54 (0.100)	2.79 (0.110)
	PAPER					EMBOSSED							

# Automotive MLCC - X8R

## Capacitance Range



SIZE		0603		0805		1206	
Soldering		Reflow/Wave		Reflow/Wave		Reflow/Wave	
WVDC	WVDC	25V	50V	25V	50V	25V	50V
271	Cap	270	G	G			
331	(pF)	330	G	G	J	J	
471		470	G	G	J	J	
681		680	G	G	J	J	
102		1000	G	G	J	J	J
152		1500	G	G	J	J	J
182		1800	G	G	J	J	J
222		2200	G	G	J	J	J
272		2700	G	G	J	J	J
332		3300	G	G	J	J	J
392		3900	G	G	J	J	J
472		4700	G	G	J	J	J
562		5600	G	G	J	J	J
682		6800	G	G	J	J	J
822		8200	G	G	J	J	J
103	Cap	0.01	G	G	J	J	J
123	(F)	0.012	G	G	J	J	J
153		0.015	G	G	J	J	J
183		0.018	G	G	J	J	J
223		0.022	G	G	J	J	J
273		0.027	G	G	J	J	J
333		0.033	G	G	J	J	J
393		0.039	G	G	J	J	J
473		0.047	G	G	J	J	J
563		0.056	G		N	N	M
683		0.068	G		N	N	M
823		0.082			N	N	M
104		0.1			N	N	M
124		0.12			N	N	M
154		0.15			N	N	M
184		0.18			N		M
224		0.22			N		M
274		0.27					M
334		0.33					M
394		0.39					M
474		0.47					M
684		0.68					
824		0.82					
105		1					
WVDC	WVDC	25V	50V	25V	50V	25V	50V
SIZE		0603		0805		1206	

Letter	A	C	E	G	J	K	M	N	P	Q	X	Y	Z
Max. Thickness	0.33 (0.013)	0.56 (0.022)	0.71 (0.028)	0.90 (0.035)	0.94 (0.037)	1.02 (0.040)	1.27 (0.050)	1.40 (0.055)	1.52 (0.060)	1.78 (0.070)	2.29 (0.090)	2.54 (0.100)	2.79 (0.110)
	PAPER					EMBOSSSED							

# APS for COTS+ High Reliability Applications



## General Specifications Surface Mount NP0, X7R and X8R/L MLCCs



AVX's APS COTS+ series of multilayer ceramic capacitors offers the customer a high reliability solution with an ultralow failure rate, <1ppb, in a variety of case sizes and voltages. The APS range encompasses a wide range of dielectric types to meet the customer's requirements from low temperature/voltage capacitance change dielectric, NP0, to high performing capacitance voltage X7R to high temperature reliability dielectrics, X8R/L.

APS capacitors have a wider capacitance range than MIL spec parts that satisfies the need for higher CV demands and board space saving requirements. Each production lot is extensively tested and removes the requirement for customer specific drawings. The testing regime uses many of the MIL-STD test methods as per MIL-PRF-55681 and has a field failure rate of less than 1 ppb. The APS testing series uses AVX's unique in-house maverick testing detection system that eliminates infant mortality failures.

Applications suitable for APS include Industrial, Telecommunications, Aviation, and Military. The APS is available with a range of different termination finishes, Flexiterm®, Nickel / Tin and Tin with Pb1. Flexiterm® technology delivers improved thermo-mechanical stress resistance.

### AVX'S APS RELIABILITY TEST SUMMARY

- 100% Visual Inspection
- DPA
- IR, DF, Cap, DWV
- Maverick Lot Review
- Thermal Shock
- 85/85 Testing
- Life Testing 125°C 2xRV
- C of C with every Order
- Quarterly Data Package

Dielectric	Temperature/Percentage Cap Change
<b>NP0</b>	-30ppm +30ppm from -55°C + 125°C
<b>X7R</b>	-15% +15% from -55°C to + 125°C
<b>X8R</b>	-15% +15% from -55°C to + 150°C
<b>X8L</b>	-15% +40% from -55°C to + 150°C

### FEATURES

- The APS range has been extensively reliability tested as standard resulting in an ultralow failure rate, ≤1ppb
- The APS range is available with Flexiterm® that deliver's high thermo-mechanical stress resistance.
- High CV range enabling board space saving requirements.

### HOW TO ORDER

AP03	5	A	104	K	Q	T	2	A
Size	Voltage	Dielectric	Capacitance Code (In pF)	Capacitance Tolerance	Failure Rate	Terminations	Packaging	Special Code
AP03=0603 AP05=0803 AP06=1206 AP10=1210 AP12=1812 AP20=2220	10V = Z 16V = Y 25V = 3 50V = 5 100V = 1 200V = 2 250V = V 500V = 7	NP0 = A X7R = C X8R = F X8L = L	2 Sig. Digits + Number of Zeros e.g. 10 F = 106	J = ±5% K = ±10% M = ±20%	Q = APS	T = Plated Ni and Sn Z = FLEXITERM®** B = 10% min lead X = FLEXITERM® with 10% min lead  Z,X for X7R only **RoHS compliant	2 = 7" Reel 4 = 13" Reel	A = Std.Product

NOTE: Contact factory for availability of Termination and Tolerance Options for Specific Part Number.

# APS COTS+ NP0 Series

## Capacitance Range



Size	AP03 = 0603			AP05 = 0805			AP06 = 1206					AP10 = 1210			
	25V	50V	100V	25V	50V	100V	25V	50V	100V	200V	500V	25V	50V	100V	200V
100 10pF	G	G	G	J	J	J	J	J	J	J	J				
120 12	G	G	G	J	J	J	J	J	J	J	J				
150 15	G	G	G	J	J	J	J	J	J	J	J				
180 18	G	G	G	J	J	J	J	J	J	J	J				
220 22	G	G	G	J	J	J	J	J	J	J	J				
270 27	G	G	G	J	J	J	J	J	J	J	J				
330 33	G	G	G	J	J	J	J	J	J	J	J				
390 39	G	G	G	J	J	J	J	J	J	J	J				
470 47	G	G	G	J	J	J	J	J	J	J	J				
510 51	G	G	G	J	J	J	J	J	J	J	J				
560 56	G	G	G	J	J	J	J	J	J	J	J				
680 68	G	G	G	J	J	J	J	J	J	J	J				
820 82	G	G	G	J	J	J	J	J	J	J	J				
101 100	G	G	G	J	J	J	J	J	J	J	J				
121 120	G	G	G	J	J	J	J	J	J	J	J				
151 150	G	G	G	J	J	J	J	J	J	J	J				
181 180	G	G	G	J	J	J	J	J	J	J	J				
221 220	G	G	G	J	J	J	J	J	J	J	J				
271 270	G	G	G	J	J	J	J	J	J	J	J				
331 330	G	G	G	J	J	J	J	J	J	J	J				
391 390	G	G		J	J	J	J	J	J	J	J				
471 470	G	G		J	J	J	J	J	J	J	J				
561 560				J	J	J	J	J	J	J	J				
681 680				J	J	J	J	J	J	J	J				
821 820				J	J	J	J	J	J	J	J				
102 1000				J	J	J	J	J	J	J	J	J	J	J	J
122 1200												J	J	M	M
152 1500												J	J	M	M
182 1800												J	J	M	M
222 2200												J	J	M	M
272 2700															
332 3300															
392 3900															
472 4700															
103 10nF															
WVDC	25V	50V	100V	25V	50V	100V	25V	50V	100V	200V	500V	25V	50V	100V	200V
Size	AP03 = 0603			AP05 = 0805			AP06 = 1206					AP10 = 1210			



Letter	A	C	E	G	J	K	M	N	P	Q	X	Y	Z
Max. Thickness	0.33 (0.013)	0.56 (0.022)	0.71 (0.028)	0.90 (0.035)	0.94 (0.037)	1.02 (0.040)	1.27 (0.050)	1.40 (0.055)	1.52 (0.060)	1.78 (0.070)	2.29 (0.090)	2.54 (0.100)	2.79 (0.110)
	PAPER					EMBOSSSED							

TS 16949, ISO 9001 Certified

# APS COTS+ X7R Series



## Capacitance Range

Size	AP03 = 0603					AP05 = 0805					AP06 = 1206					AP10 = 1210				AP12=1812		AP20 = 2220			
WVDC	16V	25V	50V	100V	200V	16V	25V	50V	100V	200V	16V	25V	50V	100V	200V	500V	16V	25V	50V	100V	50V	100V	25V	50V	100V
102 Cap 1000	G	G	G	G	G	J	J	J	J	J	J	J	J	J	J	J	K	K	K	K	K	K			
182 (pF) 1800	G	G	G	G		J	J	J	J	J	J	J	J	J	J	J	K	K	K	K	K	K			
222 2200	G	G	G	G		J	J	J	J	J	J	J	J	J	J	J	K	K	K	K	K	K			
332 3300	G	G	G	G		J	J	J	J	J	J	J	J	J	J	J	K	K	K	K	K	K			
472 4700	G	G	G	G		J	J	J	J	J	J	J	J	J	J	J	K	K	K	K	K	K			
103 0.01	G	G	G	G		J	J	J	J	J	J	J	J	J	J	J	K	K	K	K	K	K			
123 0.012	G	G	G			J	J	J	M		J	J	J	J	J		K	K	K	K	K	K			
153 0.015	G	G	G			J	J	J	M		J	J	J	J	J		K	K	K	K	K	K			
183 0.018	G	G	G			J	J	J	M		J	J	J	J	J		K	K	K	K	K	K			
223 0.022	G	G	G			J	J	J	M		J	J	J	J	J		K	K	K	K	K	K			
273 0.027	G	G	G			J	J	J	M		J	J	J	J	J		K	K	K	K	K	K			
333 0.033	G	G	G			J	J	J	M		J	J	J	J	J		K	K	K	K	K	K			
473 0.047	G	G	G			J	J	J	M		J	J	J	M	J		K	K	K	K	K	K			
563 0.056	G	G	G			J	J	J	M		J	J	J	M	J		K	K	K	M	K	K			
683 0.068	G	G	G			J	J	J	M		J	J	J	M	J		K	K	K	M	K	K			
823 0.082	G	G	G			J	J	J	M		J	J	J	M	J		K	K	K	M	K	K			
104 0.1	G	G	G			J	J	M	M		J	J	J	M	J		K	K	K	M	K	K			
124 0.12						J	J	M	N		J	J	M	M			K	K	K	P	K	K			
154 0.15						M	N	M	N		J	J	M	M			K	K	K	P	K	K			
224 0.22						M	N	M	N		J	M	M	Q			M	M	M	P	M	M			
334 0.33						N	N	M	N		J	M	P	Q			P	P	P	Q	X	X			
474 0.47						N	N	M	N		M	M	P	Q			P	P	P	Q	X	X			
684 0.68						N	N	N			M	Q	Q	Q			P	P	Q	X	X	X			
105 Cap 1.0						N	N	N			M	Q	Q	Q			P	Q	Q	X	X	X			
155 (uF) 1.5											Q	Q	Q				P	Q	Z	Z	X	X			
225 2.2											Q	Q	Q				X	Z	Z	Z	Z	Z			
335 3.3											Q	Q					X	Z	Z	Z	Z	Z			
475 4.7											Q	Q					X	Z	Z	Z	Z	Z			
106 10																	Z	Z						Z	Z
226 22																								Z	Z
WVDC	16V	25V	50V	100V	200V	16V	25V	50V	100V	200V	16V	25V	50V	100V	200V	500V	16V	25V	50V	100V	50V	100V	25V	50V	100V
Size	AP03 = 0603					AP05 = 0805					AP06 = 1206					AP10 = 1210				AP12=1812		AP20 = 2220			

Letter	A	C	E	G	J	K	M	N	P	Q	X	Y	Z
Max. Thickness	0.33 (0.013)	0.56 (0.022)	0.71 (0.028)	0.90 (0.035)	0.94 (0.037)	1.02 (0.040)	1.27 (0.050)	1.40 (0.055)	1.52 (0.060)	1.78 (0.070)	2.29 (0.090)	2.54 (0.100)	2.79 (0.110)
	PAPER					EMBOSSED							

TS 16949, ISO 9001 Certified

# APS COTS+ X8R/L Series



## Capacitance Range

### X8R

SIZE		AP03 = 0603		AP05 = 0805		AP06 = 1206	
WVDC		25V	50V	25V	50V	25V	50V
331	Cap 330	G	G	J	J		
471	(pF) 470	G	G	J	J		
681	680	G	G	J	J		
102	1000	G	G	J	J	J	J
152	1500	G	G	J	J	J	J
222	2200	G	G	J	J	J	J
332	3300	G	G	J	J	J	J
472	4700	G	G	J	J	J	J
682	6800	G	G	J	J	J	J
103	Cap 0.01	G	G	J	J	J	J
153	(µF) 0.015	G	G	J	J	J	J
223	0.022	G	G	J	J	J	J
333	0.033	G	G	J	J	J	J
473	0.047	G	G	J	J	J	J
683	0.068	G		N	N	M	M
104	0.1			N	N	M	M
154	0.15			N	N	M	M
224	0.22			N		M	M
334	0.33					M	M
474	0.47					M	
684	0.68						
105	1						
WVDC		25V	50V	25V	50V	25V	50V
SIZE		0603		0805		1206	

### X8L

SIZE		AP03 = 0603			AP05 = 0805			AP06 = 1206			
WVDC		25V	50V	100V	25V	50V	100V	16V	25V	50V	100V
331	Cap 330		G	G		J	J				
471	(pF) 470		G	G		J	J				
681	680		G	G		J	J				
102	1000		G	G		J	J				
152	1500		G	G		J	J			J	J
222	2200		G	G		J	J			J	J
332	3300		G	G		J	J			J	J
472	4700		G	G		J	J			J	J
682	6800		G	G		J	J			J	J
103	Cap 0.01		G	G		J	J			J	J
153	(µF) 0.015	G	G		J	J	J			J	J
223	0.022	G	G		J	J	J			J	J
333	0.033	G	G		J	J	N			J	J
473	0.047	G	G		J	J	N			J	J
683	0.068	G	G		J	J				J	J
104	0.1	G	G		J	J				J	M
154	0.15				J	N		J	J	J	Q
224	0.22				N	N		J	J	J	Q
334	0.33				N			J	M	P	Q
474	0.47				N			M	M	P	
684	0.68							M			
105	1							M			
WVDC		25V	50V	100V	25V	50V	100V	16V	25V	50V	100V
SIZE		0603			0805			1206			

Letter	A	C	E	G	J	K	M	N	P	Q	X	Y	Z
Max. Thickness	0.33 (0.013)	0.56 (0.022)	0.71 (0.028)	0.90 (0.035)	0.94 (0.037)	1.02 (0.040)	1.27 (0.050)	1.40 (0.055)	1.52 (0.060)	1.78 (0.070)	2.29 (0.090)	2.54 (0.100)	2.79 (0.110)
	PAPER					EMBOSSED							



TS 16949, ISO 9001 Certified

## General Specifications

### GENERAL DESCRIPTION

With increased requirements from the automotive industry for additional component robustness, AVX recognized the need to produce a MLCC with enhanced mechanical strength. It was noted that many components may be subject to severe flexing and vibration when used in various under the hood automotive and other harsh environment applications.

To satisfy the requirement for enhanced mechanical strength, AVX had to find a way of ensuring electrical integrity is maintained whilst external forces are being applied to the component. It was found that the structure of the termination needed to be flexible and after much research and development, AVX launched FLEXITERM®. FLEXITERM® is designed to enhance the mechanical flexure and temperature cycling performance of a standard ceramic capacitor with an X7R dielectric. The industry standard for flexure is 2mm minimum. Using FLEXITERM®, AVX provides up to 5mm of flexure without internal cracks. Beyond 5mm, the capacitor will generally fail "open".

As well as for automotive applications FLEXITERM® will provide Design Engineers with a satisfactory solution when designing PCB's which may be subject to high levels of board flexure.

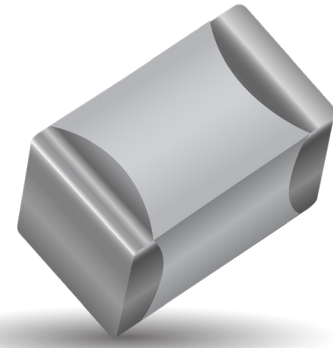

### PRODUCT ADVANTAGES

- High mechanical performance able to withstand, 5mm bend test guaranteed.
- Increased temperature cycling performance, 3000 cycles and beyond.
- Flexible termination system.
- Reduction in circuit board flex failures.
- Base metal electrode system.
- Automotive or commercial grade products available.

### APPLICATIONS

#### High Flexure Stress Circuit Boards

- e.g. Depanelization: Components near edges of board.

#### Variable Temperature Applications

- Soft termination offers improved reliability performance in applications where there is temperature variation.
- e.g. All kind of engine sensors: Direct connection to battery rail.

#### Automotive Applications

- Improved reliability.
- Excellent mechanical performance and thermo mechanical performance.

### HOW TO ORDER

0805	5	C	104	K	A	Z	2	A
<b>Style</b> 0603 0805 1206 1210 1812 2220	<b>Voltage</b> 6 = 6.3V Z = 10V Y = 16V 3 = 25V 5 = 50V 1 = 100V 2 = 200V	<b>Dielectric</b> C = X7R F = X8R	<b>Capacitance Code (In pF)</b> 2 Sig Digits + Number of Zeros e.g., 104 = 100nF	<b>Capacitance Tolerance</b> J = ±5%* K = ±10% M = ±20%  *≤1µF only	<b>Failure Rate</b> A=Commercial 4 = Automotive	<b>Terminations</b> Z = FLEXITERM® For FLEXITERM® with Tin/Lead termination see AVXLD Series	<b>Packaging</b> 2 = 7" Reel 4 = 13" Reel	<b>Special Code</b> A = Std.Product



NOTE: Contact factory for availability of Tolerance Options for Specific Part Numbers.

### PERFORMANCE TESTING

#### AEC-Q200 Qualification:

- Created by the Automotive Electronics Council
- Specification defining stress test qualification for passive components



#### Testing:

Key tests used to compare soft termination to AEC-Q200 qualification:

- Bend Test
- Temperature Cycle Test

### BOARD BEND TEST PROCEDURE

According to AEC-Q200

Test Procedure as per AEC-Q200:

Sample size: 20 components  
Span: 90mm Minimum deflection spec: 2 mm

- Components soldered onto FR4 PCB (Figure 1)
- Board connected electrically to the test equipment (Figure 2)

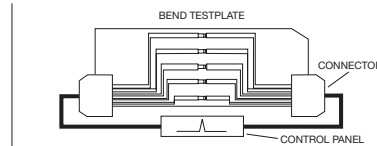

Fig 1 - PCB layout with electrical connections

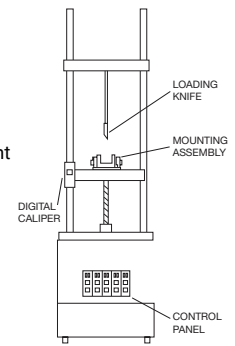
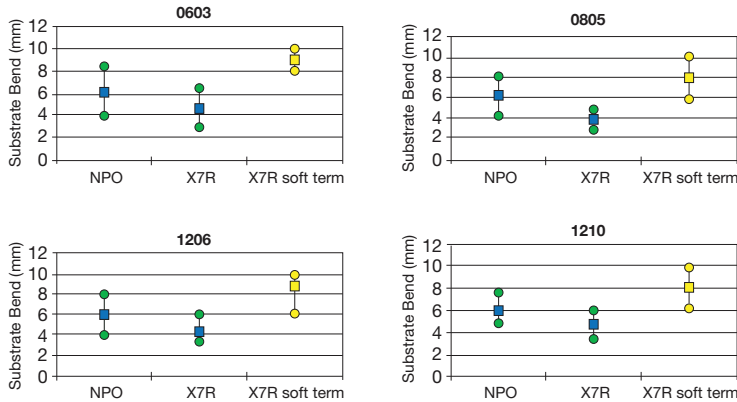

Fig 2 - Board Bend test equipment

### BOARD BEND TEST RESULTS

AEC-Q200 Vrs AVX FLEXITERM® Bend Test



### TABLE SUMMARY

Typical bend test results are shown below:

Style	Conventional Termination	FLEXITERM®
0603	>2mm	>5mm
0805	>2mm	>5mm
1206	>2mm	>5mm

### TEMPERATURE CYCLE TEST PROCEDURE

Test Procedure as per AEC-Q200:

The test is conducted to determine the resistance of the component when it is exposed to extremes of alternating high and low temperatures.

- Sample lot size quantity 77 pieces
- TC chamber cycle from -55°C to +125°C for 1000 cycles
- Interim electrical measurements at 250, 500, 1000 cycles
- Measure parameter capacitance dissipation factor, insulation resistance

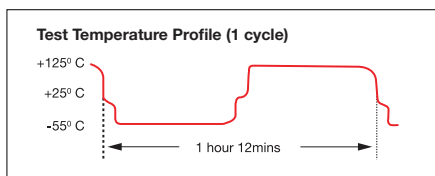

### AVX ENHANCED SOFT TERMINATION BEND TEST PROCEDURE

#### Bend Test

The capacitor is soldered to the printed circuit board as shown and is bent up to 10mm at 1mm per second:

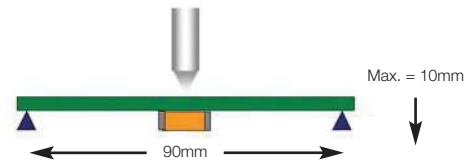

- The board is placed on 2 supports 90mm apart (capacitor side down)
- The row of capacitors is aligned with the load stressing knife



- The load is applied and the deflection where the part starts to crack is recorded (Note: Equipment detects the start of the crack using a highly sensitive current detection circuit)
- The maximum deflection capability is 10mm

**BEYOND 1000 CYCLES: TEMPERATURE CYCLE TEST RESULTS**

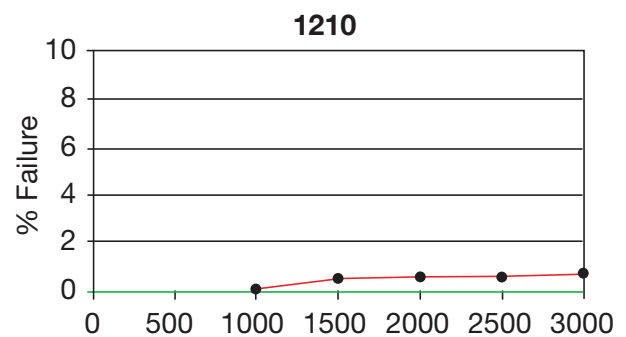
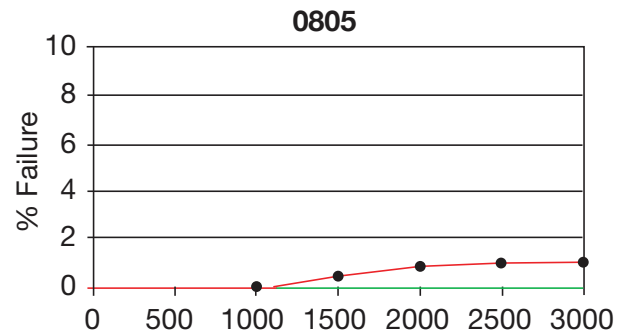

**Soft Term - No Defects up to 3000 cycles**

**AEC-Q200 specification states 1000 cycles compared to AVX 3000 temperature cycles.**

**FLEXITERM® TEST SUMMARY**

- Qualified to AEC-Q200 test/specification with the exception of using AVX 3000 temperature cycles (up to +150°C bend test guaranteed greater than 5mm).
- FLEXITERM® provides improved performance compared to standard termination systems.
- Board bend test improvement by a factor of 2 to 4 times.
- Temperature Cycling:
  - 0% Failure up to 3000 cycles
  - No ESR change up to 3000 cycle

**WITHOUT SOFT TERMINATION**



Major fear is of latent board flex failures.

**WITH SOFT TERMINATION**



Far superior mechanical performance. Generally open failure mode beyond 5mm flexure

# MLCC with FLEXITERM®

## Capacitance Range X8R Dielectric



SIZE		0603		0805		1206	
Soldering		Reflow/Wave		Reflow/Wave		Reflow/Wave	
WVDC		25V	50V	25V	50V	25V	50V
271	Cap 270	G	G				
331	(pF) 330	G	G	J	J		
471	470	G	G	J	J		
681	680	G	G	J	J		
102	1000	G	G	J	J	J	J
152	1500	G	G	J	J	J	J
182	1800	G	G	J	J	J	J
222	2200	G	G	J	J	J	J
272	2700	G	G	J	J	J	J
332	3300	G	G	J	J	J	J
392	3900	G	G	J	J	J	J
472	4700	G	G	J	J	J	J
562	5600	G	G	J	J	J	J
682	6800	G	G	J	J	J	J
822	8200	G	G	J	J	J	J
103	Cap 0.01	G	G	J	J	J	J
123	(µF) 0.012	G	G	J	J	J	J
153	0.015	G	G	J	J	J	J
183	0.018	G	G	J	J	J	J
223	0.022	G	G	J	J	J	J
273	0.027	G	G	J	J	J	J
333	0.033	G	G	J	J	J	J
393	0.039	G	G	J	J	J	J
473	0.047	G	G	J	J	J	J
563	0.056	G		N	N	M	M
683	0.068	G		N	N	M	M
823	0.082			N	N	M	M
104	0.1			N	N	M	M
124	0.12			N	N	M	M
154	0.15			N	N	M	M
184	0.18			N		M	M
224	0.22			N		M	M
274	0.27					M	M
334	0.33					M	M
394	0.39					M	
474	0.47					M	
684	0.68						
824	0.82						
105	1						
WVDC		25V	50V	25V	50V	25V	50V
SIZE		0603		0805		1206	

Letter	A	C	E	G	J	K	M	N	P	Q	X	Y	Z
Max. Thickness	0.33 (0.013)	0.56 (0.022)	0.71 (0.028)	0.90 (0.035)	0.94 (0.037)	1.02 (0.040)	1.27 (0.050)	1.40 (0.055)	1.52 (0.060)	1.78 (0.070)	2.29 (0.090)	2.54 (0.100)	2.79 (0.110)
	PAPER					EMBOSSSED							

TS 16949, ISO 9001 Certified

# MLCC with FLEXITERM®

## Capacitance Range X7R Dielectric



Size	0402			0603						0805						1206						1210				1812		2220											
Soldering	Reflow/Wave			Reflow/Wave						Reflow/Wave						Reflow/Wave						Reflow Only				Reflow Only		Reflow Only											
WVDC	16V	25V	50V	10V	16V	25V	50V	100V	200V	250V	16V	25V	50V	100V	200V	250V	16V	25V	50V	100V	200V	250V	500V	16V	25V	50V	100V	50V	100V	25V	50V	100V							
221	Cap	220	C	C	C																																		
271	(pF)	270	C	C	C																																		
331		330	C	C	C																																		
391		390	C	C	C																																		
471		470	C	C	C																																		
561		560	C	C	C																																		
681		680	C	C	C																																		
821		820	C	C	C																																		
102		1000	C	C	C	G	G	G	G	G	G	J	J	J	J	J	J	J	J	J	J	J	J	J	J	J	J	J	J	J	J	J	J	J	J	J	J		
182		1800	C	C	C	G	G	G	G	G	G	J	J	J	J	J	J	J	J	J	J	J	J	J	J	J	J	J	J	J	J	J	J	J	J	J	J		
222		2200	C	C	C	G	G	G	G	G	G	J	J	J	J	J	J	J	J	J	J	J	J	J	J	J	J	J	J	J	J	J	J	J	J	J	J	J	
332		3300	C	C	C	G	G	G	G	G	G	J	J	J	J	J	J	J	J	J	J	J	J	J	J	J	J	J	J	J	J	J	J	J	J	J	J	J	
472		4700	C	C	C	G	G	G	G	G	G	J	J	J	J	J	J	J	J	J	J	J	J	J	J	J	J	J	J	J	J	J	J	J	J	J	J	J	
103	Cap	0.01	C			G	G	G	G	G	G	J	J	J	J	J	J	J	J	J	J	J	J	J	J	J	J	J	J	J	J	J	J	J	J	J	J		
123	(µF)	0.012	C			G	G	G				J	J	J	M	J	J	J	J	J	J	J	J	J	J	J	J	J	J	J	J	J	J	J	J	J	J		
153		0.015	C			G	G	G				J	J	J	M	J	J	J	J	J	J	J	J	J	J	J	J	J	J	J	J	J	J	J	J	J	J	J	
183		0.018	C			G	G	G				J	J	J	M	J	J	J	J	J	J	J	J	J	J	J	J	J	J	J	J	J	J	J	J	J	J	J	
223		0.022	C			G	G	G				J	J	J	J	J	J	J	J	J	J	J	J	J	J	J	J	J	J	J	J	J	J	J	J	J	J	J	
273		0.027	C			G	G	G				J	J	J	M	J	J	J	J	J	J	J	J	J	J	J	J	J	J	J	J	J	J	J	J	J	J	J	
333		0.033	C			G	G	G				J	J	J	M	J	J	J	J	J	J	J	J	J	J	J	J	J	J	J	J	J	J	J	J	J	J	J	
473		0.047				G	G	G				J	J	J	M	J	J	J	J	J	J	J	J	J	J	J	J	J	J	J	J	J	J	J	J	J	J	J	
563		0.056				G	G	G				J	J	J	M			J	J	J	M	J	J	J	J	J	J	J	J	J	J	J	J	J	J	J	J	J	
683		0.068				G	G	G				J	J	J	M			J	J	J	M	J	J	J	J	J	J	J	J	J	J	J	J	J	J	J	J	J	
823		0.082				G	G	G				J	J	J	M			J	J	J	M	J	J	J	J	J	J	J	J	J	J	J	J	J	J	J	J	J	
104		0.1	C			G	G	G				J	J	J	M	M		J	J	J	M	J	J	J	J	J	J	J	J	J	J	J	J	J	J	J	J	J	
124		0.12										J	J	M	N			J	J	M	M																		
154		0.15										M	N	M	N			J	J	M	M																		
224		0.22				G						M	N	M	N			J	M	M	Q																		
334		0.33										N	N	M	N			J	M	P	Q																		
474		0.47										N	N	M	N			M	M	P	Q																		
684		0.68										N	N	N				M	Q	Q	Q																		
105		1										N	N	N				M	Q	Q	Q																		
155		1.5																Q	Q	Q																			
225		2.2																Q	Q	Q																			
335		3.3																Q	Q																				
475		4.7																Q	Q																				
106		10																																					Z
226		22																																				Z	
WVDC	16V	25V	50V	10V	16V	25V	50V	100V	200V	250V	16V	25V	50V	100V	200V	250V	16V	25V	50V	100V	200V	250V	500V	16V	25V	50V	100V	50V	100V	25V	50V	100V							
Size	0402			0603						0805						1206						1210				1812		2220											

Letter	A	C	E	G	J	K	M	N	P	Q	X	Y	Z
Max. Thickness	0.33 (0.013)	0.56 (0.022)	0.71 (0.028)	0.90 (0.035)	0.94 (0.037)	1.02 (0.040)	1.27 (0.050)	1.40 (0.055)	1.52 (0.060)	1.78 (0.070)	2.29 (0.090)	2.54 (0.100)	2.79 (0.110)
	PAPER					EMBOSSED							

# FLEXISAFE MLC Chips

## General Specifications and Capacitance Range For Ultra Safety Critical Applications



AVX have developed a range of components specifically for safety critical applications.

Utilizing the award-winning FLEXITERM™ layer in conjunction with the cascade design previously used for high voltage MLCCs, a range of ceramic capacitors is now available for customers who require components designed with an industry leading set of safety features.

The FLEXITERM™ layer protects the component from any damage to the ceramic resulting from mechanical stress during PCB assembly or use with end customers. Board flexure type mechanical damage accounts for the majority of MLCC failures. The addition of the cascade structure protects the component from low insulation resistance failure resulting from other common causes for failure; thermal stress damage, repetitive strike ESD damage and placement damage. With the inclusion of the cascade design structure to complement the FLEXITERM™ layer, the FLEXISAFE range of capacitors has unbeatable safety features.

### HOW TO ORDER

<b>0805</b>	<b>5</b>	<b>C</b>	<b>104</b>	<b>K</b>	<b>Q</b>	<b>Z</b>	<b>2</b>	<b>A</b>
<b>Size</b> FS03 = 0603 FS05 = 0805 FS06 = 1206 FS10 = 1210	<b>Voltage</b> 16V = Y 25V = 3 50V = 5 100V = 1	<b>Dielectric</b> X7R = C	<b>Capacitance Code (In pF)</b> 2 Sig. Digits + Number of Zeros e.g. 10µF =106	<b>Capacitance Tolerance</b> J = ±5% K = ±10% M = ±20%	<b>Failure Rate</b> A = Commercial 4 = Automotive Q = APS	<b>Terminations</b> Z= FLEXITERMTM *X= FLEXITERMTM with 5% min lead *Not RoHS Compliant	<b>Packaging</b> 2 = 7" Reel 4 = 13" Reel	<b>Special Code</b> A = Std.Product

### FLEXISAFE X7R RANGE

Capacitance Code	FS03 = 0603				FS05 = 0805				FS06 = 1206			FS10 = 1210		
	Soldering				Soldering				Soldering			Soldering		
	Reflow/Wave				Reflow/Wave				Reflow/Wave			Reflow Only		
	16	25	50	100	16	25	50	100	16	25	50	16	25	50
102	µF	0.001												
182		0.0018												
222		0.0022												
332		0.0033												
472		0.0047												
103		0.01												
123		0.012												
153		0.015												
183		0.018												
223		0.022												
273		0.027												
333		0.033												
473		0.047												
563		0.056												
683		0.068												
823		0.082												
104		0.1												
124		0.12												
154		0.15												
224		0.22												
334		0.33												
474		0.47												

Qualified



# Capacitor Array

## Capacitor Array (IPC)



### BENEFITS OF USING CAPACITOR ARRAYS

AVX capacitor arrays offer designers the opportunity to lower placement costs, increase assembly line output through lower component count per board and to reduce real estate requirements.

#### Reduced Costs

Placement costs are greatly reduced by effectively placing one device instead of four or two. This results in increased throughput and translates into savings on machine time. Inventory levels are lowered and further savings are made on solder materials, etc.

#### Space Saving

Space savings can be quite dramatic when compared to the use of discrete chip capacitors. As an example, the 0508 4-element array offers a space reduction of >40% vs. 4 x 0402 discrete capacitors and of >70% vs. 4 x 0603 discrete capacitors. (This calculation is dependent on the spacing of the discrete components.)

#### Increased Throughput

Assuming that there are 220 passive components placed in a mobile phone:

A reduction in the passive count to 200 (by replacing discrete components with arrays) results in an increase in throughput of approximately 9%.

A reduction of 40 placements increases throughput by 18%.

For high volume users of cap arrays using the very latest placement equipment capable of placing 10 components per second, the increase in throughput can be very significant and can have the overall effect of reducing the number of placement machines required to mount components:

If 120 million 2-element arrays or 40 million 4-element arrays were placed in a year, the requirement for placement equipment would be reduced by one machine.

During a 20Hr operational day a machine places 720K components. Over a working year of 167 days the machine can place approximately 120 million. If 2-element arrays are mounted instead of discrete components, then the number of placements is reduced by a factor of two and in the scenario where 120 million 2-element arrays are placed there is a saving of one pick and place machine.

Smaller volume users can also benefit from replacing discrete components with arrays. The total number of placements is reduced thus creating spare capacity on placement machines. This in turn generates the opportunity to increase overall production output without further investment in new equipment.

### W2A (0508) Capacitor Arrays



The 0508 4-element capacitor array gives a PCB space saving of over 40% vs four 0402 discrettes and over 70% vs four 0603 discrete capacitors.

### W3A (0612) Capacitor Arrays



The 0612 4-element capacitor array gives a PCB space saving of over 50% vs four 0603 discrettes and over 70% vs four 0805 discrete capacitors.

# Capacitor Array

## Capacitor Array (IPC)



### GENERAL DESCRIPTION

AVX is the market leader in the development and manufacture of capacitor arrays. The array family of products also includes the 0612 4-element device as well as 0508 2-element and 4-element series, all of which have received widespread acceptance in the marketplace.

AVX capacitor arrays are available in X5R, X7R and NP0 (COG) ceramic dielectrics to cover a broad range of capacitance values. Voltage ratings from 6.3 Volts up to 100 Volts are offered. AVX also now offers a range of automotive capacitor arrays qualified to AEC-Q200 (see separate table).

Key markets for capacitor arrays are Mobile and Cordless Phones, Digital Set Top Boxes, Computer Motherboards and Peripherals as well as Automotive applications, RF Modems, Networking Products, etc.

AVX Capacitor Array - W2A41A\*\*\*K  
S21 Magnitude



### HOW TO ORDER

<b>W</b>	<b>2</b>	<b>A</b>	<b>4</b>	<b>3</b>	<b>C</b>	<b>103</b>	<b>M</b>	<b>A</b>	<b>T</b>	<b>2A</b>
<b>Style</b> W = RoHS L = SnPb	<b>Case Size</b> 2 = 0508 3 = 0612	<b>Array</b>	<b>Number of Caps</b> 2 = 2 Element 4 = 4 Element	<b>Voltage</b> 6 = 6V Z = 10V Y = 16V 5 = 50V 1 = 100V	<b>Dielectric</b> A = NP0 C = X7R D = X5R	<b>Capacitance Code</b> 2 Sig. Digits + Number of Zeros	<b>Capacitance Tolerance</b> J = ±5% K = ±10% M = ±20%	<b>Failure Rate</b> A = Commercial 4 = Automotive	<b>Termination Code</b> *T = Plated Ni and Sn *Z = FLEXITERM® *B = 5% min lead *X = FLEXITERM® with 5% min lead	<b>Packaging &amp; Quantity Code</b> 2A = 7" Reel (4000) 4A = 13" Reel (10000) 2F = 7" Reel (1000)
									*RoHS Compliant	*Not RoHS Compliant



NOTE: Contact factory for availability of Termination and Tolerance Options for Specific Part Numbers.

# Capacitor Array

## Capacitance Range – NP0/COG



SIZE			W2 = 0508			W3 = 0612		
# Elements			4			4		
Soldering			Reflow/Wave			Reflow/Wave		
Packaging			Paper/Embossed			Paper/Embossed		
Length	mm		1.30 ± 0.15			1.60 ± 0.150		
	(in.)		(0.051 ± 0.006)			(0.063 ± 0.006)		
Width	mm		2.10 ± 0.15			3.20 ± 0.20		
	(in.)		(0.083 ± 0.006)			(0.126 ± 0.008)		
Max. Thickness	mm		0.94			1.35		
	(in.)		(0.037)			(0.053)		
WVDC			16	25	50	16	25	50
1R0	Cap	1.0						
1R2	(pF)	1.2						
1R5		1.5						
1R8		1.8						
2R2		2.2						
2R7		2.7						
3R3		3.3						
3R9		3.9						
4R7		4.7						
5R6		5.6						
6R8		6.8						
8R2		8.2						
100		10						
120		12						
150		15						
180		18						
220		22						
270		27						
330		33						
390		39						
470		47						
560		56						
680		68						
820		82						
101		100						
121		120						
151		150						
181		180						
221		220						
271		270						
331		330						
391		390						
471		470						
561		560						
681		680						
821		820						
102		1000						
122		1200						
152		1500						
182		1800						
222		2200						
272		2700						
332		3300						
392		3900						
472		4700						
562		5600						
682		6800						
822		8200						

 = Supported Values

# Capacitor Array

## Capacitance Range – X7R



SIZE		W2 = 0508						W2 = 0508						W3 = 0612					
# Elements		2						4						4					
Soldering		Reflow/Wave						Reflow/Wave						Reflow/Wave					
Packaging		All Paper						Paper/Embossed						Paper/Embossed					
Length	mm	1.30 ± 0.15						1.30 ± 0.15						1.60 ± 0.150					
	(in.)	(0.051 ± 0.006)						(0.051 ± 0.006)						(0.063 ± 0.006)					
Width	mm	2.10 ± 0.15						2.10 ± 0.15						3.20 ± 0.20					
	(in.)	(0.083 ± 0.006)						(0.083 ± 0.006)						(0.126 ± 0.008)					
Max. Thickness	mm	0.94						0.94						1.35					
	(in.)	(0.037)						(0.037)						(0.053)					
WVDC		6	10	16	25	50	100	6	10	16	25	50	100	6	10	16	25	50	100
101	Cap	100																	
121	(PF)	120																	
151		150																	
181		180																	
221		220																	
271		270																	
331		330																	
391		390																	
471		470																	
561		560																	
681		680																	
821		820																	
102		1000																	
122		1200																	
152		1500																	
182		1800																	
222		2200																	
272		2700																	
332		3300																	
392		3900																	
472		4700																	
562		5600																	
682		6800																	
822		8200																	
103	Cap	0.010																	
123	(µF)	0.012																	
153		0.015																	
183		0.018																	
223		0.022																	
273		0.027																	
333		0.033																	
393		0.039																	
473		0.047																	
563		0.056																	
683		0.068																	
823		0.082																	
104		0.10																	
124		0.12																	
154		0.15																	
184		0.18																	
224		0.22																	
274		0.27																	
334		0.33																	
474		0.47																	
564		0.56																	
684		0.68																	
824		0.82																	
105		1.0																	
125		1.2																	
155		1.5																	
185		1.8																	
225		2.2																	
335		3.3																	
475		4.7																	
106		10																	
226		22																	
476		47																	
107		100																	

# Capacitor Array

## Automotive Capacitor Array (IPC)

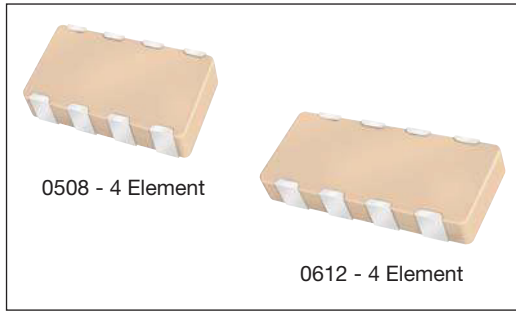

As the market leader in the development and manufacture of capacitor arrays AVX is pleased to offer a range of AEC-Q200 qualified arrays to compliment our product offering to the Automotive industry. Both the AVX 0612 and 0508 4-element capacitor array styles are qualified to the AEC-Q200 automotive specifications.

AEC-Q200 is the Automotive Industry qualification standard and a detailed qualification package is available on request.

All AVX automotive capacitor array production facilities are certified to ISO/TS 16949:2002.

### HOW TO ORDER

<b>W</b>	<b>3</b>	<b>A</b>	<b>4</b>	<b>Y</b>	<b>C</b>	<b>104</b>	<b>K</b>	<b>4</b>	<b>T</b>	<b>2A</b>
↓	↓	↓	↓	↓	↓	↓	↓	↓	↓	↓
<b>Style</b> W = RoHS L = SnPb	<b>Case Size</b> 2 = 0508 3 = 0612	<b>Array</b>	<b>Number of Caps</b>	<b>Voltage</b> Z = 10V Y = 16V 3 = 25V 5 = 50V 1 = 100V	<b>Dielectric</b> A = NP0 C = X7R F = X8R	<b>Capacitance Code (In pF)</b> Significant Digits + Number of Zeros e.g. 10µF=106	<b>Capacitance Tolerance</b> *J = ±5% *K = ±10% *M = ±20%	<b>Failure Rate</b> 4 = Automotive	<b>Terminations</b> *T = Plated Ni and Sn *Z = FLEXITERM® B = 5% min lead X = FLEXITERM® with 5% min lead	<b>Packaging &amp; Quantity Code</b> 2A = 7" Reel (4000) 4A = 13" Reel (10000) 2F = 7" Reel (1000)

\*RoHS Compliant

\*Contact factory for availability by part number for K = ±10% and J = ±5% tolerance.

### NP0/COG

SIZE	W2 = 0508				W3 = 0612			
	Reflow/Wave							
No. of Elements	4				4			
WVDC	16	25	50	100	16	25	50	100
1R0 Cap 1.0								
1R2 Cap 1.2								
1R5 Cap 1.5								
1R8 1.8								
2R2 2.2								
2R7 2.7								
3R3 3.3								
3R9 3.9								
4R7 4.7								
5R6 5.6								
6R8 6.8								
8R2 8.2								
100 10								
120 12								
150 15								
180 18								
220 22								
270 27								
330 33								
390 39								
470 47								
560 56								
680 68								
820 82								
101 100								
121 120								
151 150								
181 180								
221 220								
271 270								
331 330								
391 390								
471 470								
561 560								
681 680								
821 820								
102 1000								
122 1200								
152 1500								
182 1800								
222 2200								
272 2700								
332 3300								
392 3900								
472 4700								
562 5600								
682 6800								
822 8200								

■ = NP0/COG

### X7R

SIZE	W2 = 0508				W2 = 0508				W3 = 0612				
	Reflow/Wave												
No. of Elements	2				4				4				
WVDC	16	25	50	100	16	25	50	100	10	16	25	50	100
101 Cap 100													
121 Cap 120													
151 Cap 150													
181 180													
221 220													
271 270													
331 330													
391 390													
471 470													
561 560													
681 680													
821 820													
102 1000													
122 1200													
152 1500													
182 1800													
222 2200													
272 2700													
332 3300													
392 3900													
472 4700													
562 5600													
682 6800													
822 8200													
103 Cap 0.010													
123 Cap 0.012													
153 Cap 0.015													
183 0.018													
223 0.022													
273 0.027													
333 0.033													
393 0.039													
473 0.047													
563 0.056													
683 0.068													
823 0.082													
104 0.10													
124 0.12													
154 0.15													
224 0.22													

■ = X7R

\*Not RoHS Compliant



For RoHS compliant products, please select correct termination style.



# Capacitor Array

## Part & Pad Layout Dimensions



### PART & PAD LAYOUT DIMENSIONS

millimeters (inches)



### PART DIMENSIONS

#### 0508 - 2 Element

L	W	T	BW	BL	P	S
1.30 ± 0.15 (0.051 ± 0.006)	2.10 ± 0.15 (0.083 ± 0.006)	0.94 MAX (0.037 MAX)	0.43 ± 0.10 (0.017 ± 0.004)	0.33 ± 0.08 (0.013 ± 0.003)	1.00 REF (0.039 REF)	0.50 ± 0.10 (0.020 ± 0.004)

#### 0508 - 4 Element

L	W	T	BW	BL	P	X	S
1.30 ± 0.15 (0.051 ± 0.006)	2.10 ± 0.15 (0.083 ± 0.006)	0.94 MAX (0.037 MAX)	0.25 ± 0.06 (0.010 ± 0.003)	0.20 ± 0.08 (0.008 ± 0.003)	0.50 REF (0.020 REF)	0.75 ± 0.10 (0.030 ± 0.004)	0.25 ± 0.10 (0.010 ± 0.004)

#### 0612 - 4 Element

L	W	T	BW	BL	P	X	S
1.60 ± 0.20 (0.063 ± 0.008)	3.20 ± 0.20 (0.126 ± 0.008)	1.35 MAX (0.053 MAX)	0.41 ± 0.10 (0.016 ± 0.004)	0.18 <sup>+0.25</sup> <sub>-0.08</sub> (0.007 <sup>+0.010</sup> <sub>-0.003</sub> )	0.76 REF (0.030 REF)	1.14 ± 0.10 (0.045 ± 0.004)	0.38 ± 0.10 (0.015 ± 0.004)

### PAD LAYOUT DIMENSIONS

#### 0508 - 2 Element

A	B	C	D	E
0.68 (0.027)	1.32 (0.052)	2.00 (0.079)	0.46 (0.018)	1.00 (0.039)

#### 0508 - 4 Element

A	B	C	D	E
0.56 (0.022)	1.32 (0.052)	1.88 (0.074)	0.30 (0.012)	0.50 (0.020)

#### 0612 - 4 Element

A	B	C	D	E
0.89 (0.035)	1.65 (0.065)	2.54 (0.100)	0.46 (0.018)	0.76 (0.030)

# Low Inductance Capacitors



## Introduction

The signal integrity characteristics of a Power Delivery Network (PDN) are becoming critical aspects of board level and semiconductor package designs due to higher operating frequencies, larger power demands, and the ever shrinking lower and upper voltage limits around low operating voltages. These power system challenges are coming from mainstream designs with operating frequencies of 300MHz or greater, modest ICs with power demand of 15 watts or more, and operating voltages below 3 volts.

The classic PDN topology is comprised of a series of capacitor stages. Figure 1 is an example of this architecture with multiple capacitor stages.

An ideal capacitor can transfer all its stored energy to a load instantly. A real capacitor has parasitics that prevent instantaneous transfer of a capacitor's stored energy. The true nature of a capacitor can be modeled as an RLC equivalent circuit. For most simulation purposes, it is possible to model the characteristics of a real capacitor with one capacitor, one resistor, and one inductor. The RLC values in this model are commonly referred to as equivalent series capacitance (ESC), equivalent series resistance (ESR), and equivalent series inductance (ESL).

The ESL of a capacitor determines the speed of energy transfer to a load. The lower the ESL of a capacitor, the faster that energy can be transferred to a load. Historically, there has been a tradeoff between energy storage (capacitance) and inductance (speed of energy delivery). Low ESL devices typically have low capacitance. Likewise, higher capacitance devices typically have higher ESLs. This tradeoff between ESL (speed of energy delivery) and capacitance (energy storage) drives the PDN design topology that places the fastest low ESL capacitors as close to the load as possible. Low Inductance MLCCs are found on semiconductor packages and on boards as close as possible to the load.



Figure 1 Classic Power Delivery Network (PDN) Architecture

## LOW INDUCTANCE CHIP CAPACITORS

The key physical characteristic determining equivalent series inductance (ESL) of a capacitor is the size of the current loop it creates. The smaller the current loop, the lower the ESL. A standard surface mount MLCC is rectangular in shape with electrical terminations on its shorter sides. A Low Inductance Chip Capacitor (LICC) sometimes referred to as Reverse Geometry Capacitor (RGC) has its terminations on the longer side of its rectangular shape.

When the distance between terminations is reduced, the size of the current loop is reduced. Since the size of the current loop is the primary driver of inductance, an 0306 with a smaller current loop has significantly lower ESL than an 0603. The reduction in ESL varies by EIA size, however, ESL is typically reduced 60% or more with an LICC versus a standard MLCC.

## INTERDIGITATED CAPACITORS

The size of a current loop has the greatest impact on the ESL characteristics of a surface mount capacitor. There is a secondary method for decreasing the ESL of a capacitor. This secondary method uses adjacent opposing current loops to reduce ESL. The InterDigitated Capacitor (IDC) utilizes both primary and secondary methods of reducing inductance. The IDC architecture shrinks the distance between terminations to minimize the current loop size, then further reduces inductance by creating adjacent opposing current loops.

An IDC is one single capacitor with an internal structure that has been optimized for low ESL. Similar to standard MLCC versus LICCs, the reduction in ESL varies by EIA case size. Typically, for the same EIA size, an IDC delivers an ESL that is at least 80% lower than an MLCC.

# Low Inductance Capacitors



## Introduction

### LAND GRID ARRAY (LGA) CAPACITORS

Land Grid Array (LGA) capacitors are based on the first Low ESL MLCC technology created to specifically address the design needs of current day Power Delivery Networks (PDNs). This is the 3rd low inductance capacitor technology developed by AVX. LGA technology provides engineers with new options. The LGA internal structure and manufacturing technology eliminates the historic need for a device to be physically small to create small current loops to minimize inductance.

The first family of LGA products are 2 terminal devices. A 2 terminal 0306 LGA delivers ESL performance that is equal to or better than an 0306 8 terminal IDC. The 2 terminal 0805 LGA delivers ESL performance that approaches the 0508 8 terminal IDC. New designs that would have used 8 terminal IDCs are moving to 2 terminal LGAs because the layout is easier for a 2 terminal device and manufacturing yield is better for a 2 terminal LGA versus an 8 terminal IDC.

LGA technology is also used in a 4 terminal family of products that AVX is sampling and will formerly introduce in 2008. Beyond 2008, there are new multi-terminal LGA product families that will provide even more attractive options for PDN designers.

### LOW INDUCTANCE CHIP ARRAYS (LICA®)

The LICA® product family is the result of a joint development effort between AVX and IBM to develop a high performance MLCC family of decoupling capacitors. LICA was introduced in the 1980s and remains the leading choice of designers in high performance semiconductor packages and high reliability board level decoupling applications.

LICA® products are used in 99.999% uptime semiconductor package applications on both ceramic and organic substrates. The C4 solder ball termination option is the perfect compliment to flip-chip packaging technology. Mainframe class CPUs, ultimate performance multi-chip modules, and communications systems that must have the reliability of 5 9's use LICA®.

LICA® products with either Sn/Pb or Pb-free solder balls are used for decoupling in high reliability military and aerospace applications. These LICA® devices are used for decoupling of large pin count FPGAs, ASICs, CPUs, and other high power ICs with low operating voltages.

When high reliability decoupling applications require the very lowest ESL capacitors, LICA® products are the best option.

### 470 nF 0306 Impedance Comparison



Figure 2 MLCC, LICC, IDC, and LGA technologies deliver different levels of equivalent series inductance (ESL).



# Low Inductance Ceramic Capacitors

## LICC (Low Inductance Chip Capacitors) 0306/0508/0612 RoHS Compliant



### GENERAL DESCRIPTION

The key physical characteristic determining equivalent series inductance (ESL) of a capacitor is the size of the current loop it creates. The smaller the current loop, the lower the ESL.

A standard surface mount MLCC is rectangular in shape with electrical terminations on its shorter sides. A Low Inductance Chip Capacitor (LICC) sometimes referred to as Reverse Geometry Capacitor (RGC) has its terminations on the longer sides of its rectangular shape. The image on the right shows the termination differences between an MLCC and an LICC.

When the distance between terminations is reduced, the size of the current loop is reduced. Since the size of the current loop is the primary driver of inductance, an 0306 with a smaller current loop has significantly lower ESL than an 0603. The reduction in ESL varies by EIA size, however, ESL is typically reduced 60% or more with an LICC versus a standard MLCC.

AVX LICC products are available with a lead-free finish of plated Nickel/Tin.



### PERFORMANCE CHARACTERISTICS

<b>Capacitance Tolerances</b>	K = $\pm 10\%$ ; M = $\pm 20\%$
<b>Operation Temperature Range</b>	X7R = -55°C to +125°C X5R = -55°C to +85°C X7S = -55°C to +125°C
<b>Temperature Coefficient</b>	X7R, X5R = $\pm 15\%$ ; X7S = $\pm 22\%$
<b>Voltage Ratings</b>	4, 6.3, 10, 16, 25 VDC
<b>Dissipation Factor</b>	4V, 6.3V = 6.5% max; 10V = 5.0% max; 16V = 3.5% max; 25V = 3.0% max
<b>Insulation Resistance (@+25°C, RVDC)</b>	100,000M $\Omega$ min, or 1,000M $\Omega$ per $\mu$ F min., whichever is less

### HOW TO ORDER

**0612**

Size  
0306  
0508  
0612

**Z**

Voltage  
4 = 4V  
6 = 6.3V  
Z = 10V  
Y = 16V  
3 = 25V  
5 = 50V

**D**

Dielectric  
C = X7R  
D = X5R  
W = X6S  
Z = X7S

**105**

Capacitance Code (In pF)  
2 Sig. Digits + Number of Zeros

**M**

Capacitance Tolerance  
K =  $\pm 10\%$   
M =  $\pm 20\%$

**A**

Failure Rate  
A = N/A

**T**

Terminations  
T = Plated Ni and Sn

**2**

Packaging Available  
2 = 7" Reel  
4 = 13" Reel

**A\***

Thickness  
Thickness  
mm (in)  
0.56 (0.022)  
0.76 (0.030)  
1.02 (0.040)  
1.27 (0.050)

\*See the thickness tables on the next page.

NOTE: Contact factory for availability of Termination and Tolerance Options for Specific Part Numbers.

### TYPICAL IMPEDANCE CHARACTERISTICS



# Low Inductance Ceramic Capacitors

LICC (Low Inductance Chip Capacitors) 0306/0508/0612 RoHS Compliant



SIZE		0306					0508					0612				
Packaging		Embossed					Embossed					Embossed				
Length	mm	0.81 ± 0.15					1.27 ± 0.25					1.60 ± 0.25				
	(in.)	(0.032 ± 0.006)					(0.050 ± 0.010)					(0.063 ± 0.010)				
Width	mm	1.60 ± 0.15					2.00 ± 0.25					3.20 ± 0.25				
	(in.)	(0.063 ± 0.006)					(0.080 ± 0.010)					(0.126 ± 0.010)				
Cap Code	WVDC	4	6.3	10	16	25	6.3	10	16	25	50	6.3	10	16	25	50
102	Cap 0.001	A	A	A	A	S	S	S	S	V	S	S	S	S	V	
222	(µF) .0022	A	A	A	A	S	S	S	S	V	S	S	S	S	V	
332	0.0033	A	A	A	A	S	S	S	S	V	S	S	S	S	V	
472	0.0047	A	A	A	A	S	S	S	S	V	S	S	S	S	V	
682	0.0068	A	A	A	A	S	S	S	S	V	S	S	S	S	V	
103	0.01	A	A	A	A	S	S	S	S	V	S	S	S	S	V	
153	0.015	A	A	A	A	S	S	S	S	V	S	S	S	S	W	
223	0.022	A	A	A	A	S	S	S	S	V	S	S	S	S	W	
333	0.033	A	A	A		S	S	S	V	V	S	S	S	S	W	
473	0.047	A	A	A		S	S	S	V	A	S	S	S	S	W	
683	0.068	A	A	A		S	S	S	A	A	S	S	S	V	W	
104	0.1	A	A			S	S	V	A	A	S	S	S	V	W	
154	0.15	A	A			S	S	V			S	S	S	W	W	
224	0.22	A	A			S	S	A			S	S	V	W		
334	0.33					V	V	A			S	S	V			
474	0.47					V	V				S	S	V			
684	0.68					A	A				V	V	W			
105	1	A				A	A				V	V	A			
155	1.5					A					W	W				
225	2.2										A	A				
335	3.3										A					
475	4.7															
685	6.8															
106	10															

## PHYSICAL DIMENSIONS AND PAD LAYOUT



## PHYSICAL DIMENSIONS

Size	L	W	t
<b>0306</b>	0.81 ± 0.15 (0.032 ± 0.006)	1.60 ± 0.15 (0.063 ± 0.006)	0.13 min. (0.005 min.)
<b>0508</b>	1.27 ± 0.25 (0.050 ± 0.010)	2.00 ± 0.25 (0.080 ± 0.010)	0.13 min. (0.005 min.)
<b>0612</b>	1.60 ± 0.25 (0.063 ± 0.010)	3.20 ± 0.25 (0.126 ± 0.010)	0.13 min. (0.005 min.)

T - See Range Chart for Thickness and Codes

## PAD LAYOUT DIMENSIONS

Size	A	B	C
<b>0306</b>	0.31 (0.012)	1.52 (0.060)	0.51 (0.020)
<b>0508</b>	0.51 (0.020)	2.03 (0.080)	0.76 (0.030)
<b>0612</b>	0.76 (0.030)	3.05 (0.120)	0.635 (0.025)

Solid = X7R    = X5R    = X7S    = X6S

mm (in.)	
<b>0306</b>	
Code	Thickness
A	0.56 (0.022)

mm (in.)	
<b>0508</b>	
Code	Thickness
S	0.56 (0.022)
V	0.76 (0.030)
A	1.02 (0.040)

mm (in.)	
<b>0612</b>	
Code	Thickness
S	0.56 (0.022)
V	0.76 (0.030)
W	1.02 (0.040)
A	1.27 (0.050)



# Low Inductance Capacitors with SnPb Terminations



## LD16/LD17/LD18 Tin-Lead Termination "B"

### GENERAL DESCRIPTION

The key physical characteristic determining equivalent series inductance (ESL) of a capacitor is the size of the current loop it creates. The smaller the current loop, the lower the ESL.

A standard surface mount MLCC is rectangular in shape with electrical terminations on its shorter sides. A Low Inductance Chip Capacitor (LICC) sometimes referred to as Reverse Geometry Capacitor (RGC) has its terminations on the longer sides of its rectangular shape. The image on the right shows the termination differences between an MLCC and an LICC.

When the distance between terminations is reduced, the size of the current loop is reduced. Since the size of the current loop is the primary driver of inductance, an 0306 with a smaller current loop has significantly lower ESL than an 0603. The reduction in ESL varies by EIA size, however, ESL is typically reduced 60% or more with an LICC versus a standard MLCC.

AVX LICC products are available with a lead termination for high reliability military and aerospace applications that must avoid tin whisker reliability issues.



### PERFORMANCE CHARACTERISTICS

<b>Capacitance Tolerances</b>	K = $\pm 10\%$ ; M = $\pm 20\%$
<b>Operation Temperature Range</b>	X7R = -55°C to +125°C X5R = -55°C to +85°C X7S = -55°C to +125°C
<b>Temperature Coefficient</b>	X7R, X5R = $\pm 15\%$ ; X7S = $\pm 22\%$
<b>Voltage Ratings</b>	4, 6.3, 10, 16, 25 VDC
<b>Dissipation Factor</b>	4V, 6.3V = 6.5% max; 10V = 5.0% max; 16V = 3.5% max; 25V = 3.0% max
<b>Insulation Resistance (@+25°C, RVDC)</b>	100,000M $\Omega$ min, or 1,000M $\Omega$ per $\mu$ F min., whichever is less

**\*Not RoHS Compliant**

### HOW TO ORDER

<b>LD18</b>	<b>Z</b>	<b>D</b>	<b>105</b>	<b>M</b>	<b>A</b>	<b>B</b>	<b>2</b>	<b>A*</b>
<b>Size</b> LD16 = 0306 LD17 = 0508 LD18 = 0612	<b>Voltage</b> 4 = 4V 6 = 6.3V Z = 10V Y = 16V 3 = 25V 5 = 50V	<b>Dielectric</b> C = X7R D = X5R W = X6S Z = X7S	<b>Capacitance Code (In pF)</b> 2 Sig. Digits + Number of Zeros	<b>Capacitance Tolerance</b> K = $\pm 10\%$ M = $\pm 20\%$	<b>Failure Rate</b> A = N/A	<b>Terminations</b> B = 5% min lead	<b>Packaging Available</b> 2 = 7" Reel 4 = 13" Reel	<b>Thickness</b> <b>Thickness</b> mm (in) 0.56 (0.022) 0.76 (0.030) 1.02 (0.040) 1.27 (0.050)

\*See the thickness tables on the next page.

NOTE: Contact factory for availability of Termination and Tolerance Options for Specific Part Numbers.

### TYPICAL IMPEDANCE CHARACTERISTICS



# Low Inductance Capacitors with SnPb Terminations

## LD16/LD17/LD18 Tin-Lead Termination "B"



SIZE		LD16 (0306)				LD17 (0508)					LD18 (0612)				
Packaging		Embossed				Embossed					Embossed				
Length	mm	0.81 ± 0.15				1.27 ± 0.25					1.60 ± 0.25				
	(in.)	(0.032 ± 0.006)				(0.050 ± 0.010)					(0.063 ± 0.010)				
Width	mm	1.60 ± 0.15				2.00 ± 0.25					3.20 ± 0.25				
	(in.)	(0.063 ± 0.006)				(0.080 ± 0.010)					(0.126 ± 0.010)				
Cap Code	WVDC	6.3	10	16	25	6.3	10	16	25	50	6.3	10	16	25	50
102	Cap 0.001	A	A	A	A	S	S	S	S	V	S	S	S	S	V
222	(μF) .0022	A	A	A	A	S	S	S	S	V	S	S	S	S	V
332	0.0033	A	A	A	A	S	S	S	S	V	S	S	S	S	V
472	0.0047	A	A	A	A	S	S	S	S	V	S	S	S	S	V
682	0.0068	A	A	A	A	S	S	S	S	V	S	S	S	S	V
103	0.01	A	A	A	A	S	S	S	S	V	S	S	S	S	V
153	0.015	A	A	A	A	S	S	S	S	V	S	S	S	S	W
223	0.022	A	A	A	A	S	S	S	S	V	S	S	S	S	W
333	0.033	A	A	A		S	S	S	V	V	S	S	S	S	W
473	0.047	A	A	A		S	S	S	V	V	S	S	S	S	W
683	0.068	A	A	A		S	S	S	A	A	S	S	S	V	W
104	0.1	A	A	X		S	S	V	A	A	S	S	S	V	W
154	0.15	A	A			S	S	V			S	S	S	W	W
224	0.22	A	A			S	S	A			S	S	V	W	
334	0.33					V	V	A			S	S	V		
474	0.47					V	V	X			S	S	V		
684	0.68					A	A				V	V	W		
105	1					A	A				V	V	A		
155	1.5					X					W	W			
225	2.2										A	A			
335	3.3										A				
475	4.7														
685	6.8														
106	10														

### PHYSICAL DIMENSIONS AND PAD LAYOUT



### PHYSICAL DIMENSIONS

Size	L	W	t
<b>LD16 (0306)</b>	0.81 ± 0.15 (0.032 ± 0.006)	1.60 ± 0.15 (0.063 ± 0.006)	0.13 min. (0.005 min.)
<b>LD17 (0508)</b>	1.27 ± 0.25 (0.050 ± 0.010)	2.00 ± 0.25 (0.080 ± 0.010)	0.13 min. (0.005 min.)
<b>LD18 (0612)</b>	1.60 ± 0.25 (0.063 ± 0.010)	3.20 ± 0.25 (0.126 ± 0.010)	0.13 min. (0.005 min.)

T - See Range Chart for Thickness and Codes

### PAD LAYOUT DIMENSIONS

Size	A	B	C
<b>LD16 (0306)</b>	0.31 (0.012)	1.52 (0.060)	0.51 (0.020)
<b>LD17 (0508)</b>	0.51 (0.020)	2.03 (0.080)	0.76 (0.030)
<b>LD18 (0612)</b>	0.76 (0.030)	3.05 (0.120)	0.635 (0.025)

Solid = X7R



= X5R



= X6S

mm (in.)	
LD16 (0306)	
Code	Thickness
A	0.56 (0.022)

mm (in.)	
LD17 (0508)	
Code	Thickness
S	0.56 (0.022)
V	0.76 (0.030)
A	1.02 (0.040)

mm (in.)	
LD18 (0612)	
Code	Thickness
S	0.56 (0.022)
V	0.76 (0.030)
W	1.02 (0.040)
A	1.27 (0.050)



# IDC Low Inductance Capacitors (RoHS)



## IDC (InterDigitated Capacitors) 0306/0612/0508

### GENERAL DESCRIPTION

Inter-Digitated Capacitors (IDCs) are used for both semiconductor package and board level decoupling. The equivalent series inductance (ESL) of a single capacitor or an array of capacitors in parallel determines the response time of a Power Delivery Network (PDN). The lower the ESL of a PDN, the faster the response time. A designer can use many standard MLCCs in parallel to reduce ESL or a low ESL Inter-Digitated Capacitor (IDC) device. These IDC devices are available in versions with a maximum height of 0.95mm or 0.55mm.

IDCs are typically used on packages of semiconductor products with power levels of 15 watts or greater. Inter-Digitated Capacitors are used on CPU, GPU, ASIC, and ASSP devices produced on 0.13μ, 90nm, 65nm, and 45nm processes. IDC devices are used on both ceramic and organic package substrates. These low ESL surface mount capacitors can be placed on the bottom side or the top side of a package substrate. The low profile 0.55mm maximum height IDCs can easily be used on the bottom side of BGA packages or on the die side of packages under a heat spreader.

IDCs are used for board level decoupling of systems with speeds of 300MHz or greater. Low ESL IDCs free up valuable board space by reducing the number of capacitors required versus standard MLCCs. There are additional benefits to reducing the number of capacitors beyond saving board space including higher reliability from a reduction in the number of components and lower placement costs based on the need for fewer capacitors.

The Inter-Digitated Capacitor (IDC) technology was developed by AVX. This is the second family of Low Inductance MLCC products created by AVX. IDCs are a cost effective alternative to AVX's first generation low ESL family for high-reliability applications known as LICA (Low Inductance Chip Array).

AVX IDC products are available with a lead-free finish of plated Nickel/Tin.

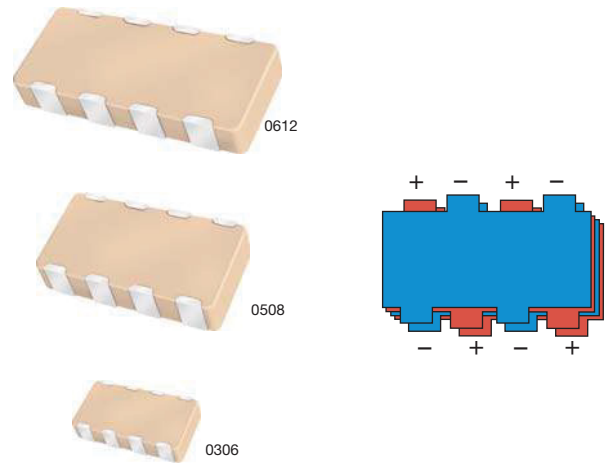

### TYPICAL IMPEDANCE

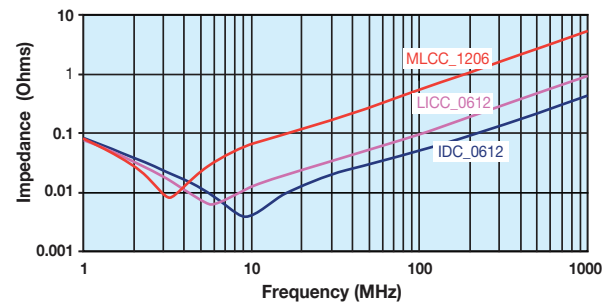

### HOW TO ORDER

<b>W</b>	<b>3</b>	<b>L</b>	<b>1</b>	<b>6</b>	<b>D</b>	<b>225</b>	<b>M</b>	<b>A</b>	<b>T</b>	<b>3</b>	<b>A</b>
<b>Style</b>	<b>IDC Case Size</b>	<b>Low Inductance</b>	<b>Number of Terminals</b>	<b>Voltage</b>	<b>Dielectric</b>	<b>Capacitance Code (In pF)</b>	<b>Capacitance Tolerance</b>	<b>Failure Rate</b>	<b>Termination</b>	<b>Packaging Available</b>	<b>Thickness</b>
	2 = 0508 3 = 0612 4 = 0306		1=8 Terminals	4 = 4V 6 = 6.3V Z = 10V Y = 16V 3 = 25V	C = X7R D = X5R Z = X7S	2 Sig. Digits + Number of Zeros	M = ±20%	A = N/A	T = Plated Ni and Sn	1=7" Reel 3=13" Reel	Max. Thickness mm (in) A=Standard S=0.55 (0.022)

NOTE: Contact factory for availability of Termination and Tolerance Options for Specific Part Numbers.



### PERFORMANCE CHARACTERISTICS

<b>Capacitance Tolerance</b>	±20% Preferred
<b>Operation Temperature Range</b>	X7R = -55°C to +125°C X5R = -55°C to +85°C X7S = -55°C to +125°C
<b>Temperature Coefficient</b>	±15% (0VDC), ±22% (X7S)
<b>Voltage Ratings</b>	4, 6.3, 10, 16, 25 VDC
<b>Dissipation Factor</b>	≤ 6.3V = 6.5% max; 10V = 5.0% max; ≥ 16V = 3.5% max
<b>Insulation Resistance (@+25°C, RVDC)</b>	100,000MΩ min, or 1,000MΩ per μF min., whichever is less

<b>Dissipation Factor</b>	No problems observed after 2.5 x RVDC for 5 seconds at 50mA max current
<b>CTE (ppm/C)</b>	12.0
<b>Thermal Conductivity</b>	4-5W/M K
<b>Terminations Available</b>	Plated Nickel and Solder



# IDC Low Inductance Capacitors (SnPb)



## IDC (InterDigitated Capacitors) 0306/0612/0508

### GENERAL DESCRIPTION

Inter-Digitated Capacitors (IDCs) are used for both semiconductor package and board level decoupling. The equivalent series inductance (ESL) of a single capacitor or an array of capacitors in parallel determines the response time of a Power Delivery Network (PDN). The lower the ESL of a PDN, the faster the response time. A designer can use many standard MLCCs in parallel to reduce ESL or a low ESL Inter-Digitated Capacitor (IDC) device. These IDC devices are available in versions with a maximum height of 0.95mm or 0.55mm.

IDCs are typically used on packages of semiconductor products with power levels of 15 watts or greater. Inter-Digitated Capacitors are used on CPU, GPU, ASIC, and ASSP devices produced on 0.13μ, 90nm, 65nm, and 45nm processes. IDC devices are used on both ceramic and organic package substrates. These low ESL surface mount capacitors can be placed on the bottom side or the top side of a package substrate. The low profile 0.55mm maximum height IDCs can easily be used on the bottom side of BGA packages or on the die side of packages under a heat spreader.

IDCs are used for board level decoupling of systems with speeds of 300MHz or greater. Low ESL IDCs free up valuable board space by reducing the number of capacitors required versus standard MLCCs. There are additional benefits to reducing the number of capacitors beyond saving board space including higher reliability from a reduction in the number of components and lower placement costs based on the need for fewer capacitors.

The Inter-Digitated Capacitor (IDC) technology was developed by AVX. This is the second family of Low Inductance MLCC products created by AVX. IDCs are a cost effective alternative to AVX's first generation low ESL family for high-reliability applications known as LICA (Low Inductance Chip Array).

AVX IDC products are available with a lead termination for high reliability military and aerospace applications that must avoid tin whisker reliability issues.



### TYPICAL IMPEDANCE



### HOW TO ORDER

W	3	L	1	6	D	225	M	A	B	3	A
<b>Style</b>	<b>IDC Case Size</b>	<b>Low Inductance</b>	<b>Number of Terminals</b>	<b>Voltage</b>	<b>Dielectric</b>	<b>Capacitance Code (In pF)</b>	<b>Capacitance Tolerance</b>	<b>Failure Rate</b>	<b>Termination</b>	<b>Packaging Available</b>	<b>Thickness</b>
	2 = 0508 3 = 0612 4 = 0306		1=8Terminals	4 = 4V 6 = 6.3V Z = 10V Y = 16V 3 = 25V	C = X7R D = X5R Z = X7S	2 Sig. Digits + Number of Zeros	M = ±20%	A = N/A	B = 5% min. Lead	1=7" Reel 3=13" Reel	Max. Thickness mm (in) A=Standard S=0.55 (0.022)

NOTE: Contact factory for availability of Termination and Tolerance Options for Specific Part Numbers.

**\*Not RoHS Compliant**

### PERFORMANCE CHARACTERISTICS

<b>Capacitance Tolerance</b>	±20% Preferred
<b>Operation Temperature Range</b>	X7R = -55°C to +125°C X5R = -55°C to +85°C X7S = -55°C to +125°C
<b>Temperature Coefficient</b>	±15% (0VDC), ±22% (X7S)
<b>Voltage Ratings</b>	4, 6.3, 10, 16, 25 VDC
<b>Dissipation Factor</b>	≤ 6.3V = 6.5% max; 10V = 5.0% max; ≥ 16V = 3.5% max
<b>Insulation Resistance (@+25°C, RVDC)</b>	100,000MΩ min, or 1,000MΩ per μF min., whichever is less

<b>Dissipation Factor</b>	No problems observed after 2.5 x RVDC for 5 seconds at 50mA max current
<b>CTE (ppm/C)</b>	12.0
<b>Thermal Conductivity</b>	4-5W/M K
<b>Terminations Available</b>	Plated Nickel and Solder

# IDC Low Inductance Capacitors (SnPb)

## IDC (InterDigitated Capacitors) with Sn/Pb Termination 0306/0612/0508



SIZE	W4 = 0306		W2 = Thin 0508			W2 = 0508			W3= Thin 0612				W3 = 0612				W3 = THICK 0612											
	Max. Thickness	mm (in.)	0.55 (0.022)		0.55 (0.022)			0.95 (0.037)			0.55 (0.022)				0.95 (0.037)				1.22 (0.048)									
WVDC			4	6.3	4	6.3	10	16	25	4	6.3	10	16	25	4	6.3	10	16	25	4	6.3	10	16	25	4	6.3	10	16
Cap (µF)	0.010																											
	0.022																											
	0.033																											
	0.047																											
	0.068																											
	0.10																											
	0.22																											
	0.33																											
	0.47																											
	0.68																											
	1.0																											
	1.5																											
	2.2																											
	3.3																											

### PHYSICAL DIMENSIONS AND PAD LAYOUT

Consult factory for additional requirements



- = X7R
- = X5R
- = X7S

### PHYSICAL CHIP DIMENSIONS MILLIMETERS (INCHES)

SIZE	W	L	BW	BL	P
<b>0306</b>	1.60 ± 0.20 (0.063 ± 0.008)	0.82 ± 0.10 (0.032 ± 0.006)	0.25 ± 0.10 (0.010 ± 0.004)	0.20 ± 0.10 (0.008 ± 0.004)	0.40 ± 0.05 (0.015 ± 0.002)
<b>0508</b>	2.03 ± 0.20 (0.080 ± 0.008)	1.27 ± 0.20 (0.050 ± 0.008)	0.30 ± 0.10 (0.012 ± 0.004)	0.25 ± 0.15 (0.010 ± 0.006)	0.50 ± 0.05 (0.020 ± 0.002)
<b>0612</b>	3.20 ± 0.20 (0.126 ± 0.008)	1.60 ± 0.20 (0.063 ± 0.008)	0.50 ± 0.10 (0.020 ± 0.004)	0.25 ± 0.15 (0.010 ± 0.006)	0.80 ± 0.10 (0.031 ± 0.004)

### PAD LAYOUT DIMENSIONS

SIZE	A	B	C	D	E
<b>0306</b>	0.38 (0.015)	0.89 (0.035)	1.27 (0.050)	0.20 (0.008)	0.40 (0.015)
<b>0508</b>	0.64 (0.025)	1.27 (0.050)	1.91 (0.075)	0.28 (0.011)	0.50 (0.020)
<b>0612</b>	0.89 (0.035)	1.65 (0.065)	2.54 (0.100)	0.45 (0.018)	0.80 (0.031)

# LGA Low Inductance Capacitors



## 0204/0306 Land Grid Array

Land Grid Array (LGA) capacitors are the latest family of low inductance MLCCs from AVX. These new LGA products are the third low inductance family developed by AVX. The innovative LGA technology sets a new standard for low inductance MLCC performance.

Our initial 2 terminal versions of LGA technology deliver the performance of an 8 terminal IDC low inductance MLCC with a number of advantages including:

- Simplified layout of 2 large solder pads compared to 8 small pads for IDCs
- Opportunity to reduce PCB or substrate contribution to system ESL by using multiple parallel vias in solder pads
- Advanced FCT manufacturing process used to create uniformly flat terminations on the capacitor that resist "tombstoning"
- Better solder joint reliability



## APPLICATIONS

### Semiconductor Packages

- Microprocessors/CPU's
- Graphics Processors/GPU's
- Chipsets
- FPGAs
- ASICs

### Board Level Device Decoupling

- Frequencies of 300 MHz or more
- ICs drawing 15W or more
- Low voltages
- High speed buses

## 0306 2 TERMINAL LGA COMPARISON WITH 0306 8 TERMINAL IDC



# LGA Low Inductance Capacitors

## 0204/0306 Land Grid Array



SIZE	LG12 (0204)						LG22 (0306)								
Length mm (in.)	0.50 (0.020)						0.76 (0.030)								
Width mm (in.)	1.00 (0.039)						1.60 (0.063)								
Temp. Char.	X5R (D)		X7S (Z)		X6S (W)		X7R (C)		X5R (D)		X7S (Z)		X6S (W)		
Working Voltage	6.3 (6)	4 (4)	6.3 (6)	4 (4)	6.3 (6)	4 (4)	10 (Z)	6.3 (6)	4 (4)	6.3 (6)	4 (4)	6.3 (6)	4 (4)	6.3 (6)	4 (4)
Cap (µF)	0.010 (103)														
	0.022 (223)														
	0.047 (473)														
	0.100 (104)														
	0.220 (224)														
	0.330 (334)														
	0.470 (474)														
	1.000 (105)														
	2.200 (225)														

= X7R   
  = X5R   
  = X7S   
  = X6S

### HOW TO ORDER

<b>LG</b>	<b>1</b>	<b>2</b>	<b>6</b>	<b>Z</b>	<b>104</b>	<b>M</b>	<b>A</b>	<b>T</b>	<b>2</b>	<b>S</b>	<b>1</b>
<b>Style</b>	<b>Case Size</b>	<b>Number of Terminals</b>	<b>Working Voltage</b>	<b>Temperature Characteristic</b>	<b>Coded Cap</b>	<b>Cap Tolerance</b>	<b>Termination Style</b>	<b>Termination</b>	<b>Packaging Tape &amp; Reel</b>	<b>Thickness</b>	<b>Number of Capacitors</b>
	1 = 0204 2 = 0306	2	4=4V 6=6.3V Z=10V	C = X7R D = X5R Z = X7S W = X6S		M = ±20%	A = "U" Land	100% Sn* <small>*Contact factory for other termination finishes</small>	2 = 7" Reel 4 = 13" Reel	S = 0.55mm max	



### PART DIMENSIONS

### MM (INCHES)

Series	L	W	T	BW	BL
<b>LG12 (0204)</b>	0.5 ± 0.05 (0.020 ± 0.002)	1.00 ± 0.10 (0.039 ± 0.004)	0.50 ± 0.05 (0.020 ± 0.002)	0.8 ± 0.10 (0.031 ± 0.004)	0.13 ± 0.08 (0.005 ± 0.003)
<b>LG22 (0306)</b>	0.76 ± 0.10 (0.030 ± 0.004)	1.60 ± 0.10 (0.063 ± 0.004)	0.50 ± 0.05 (0.020 ± 0.002)	1.50 ± 0.10 (0.059 ± 0.004)	0.28 ± 0.08 (0.011 ± 0.003)



### RECOMMENDED SOLDER PAD DIMENSIONS

### MM (INCHES)



Series	PL	PW1	G
<b>LG12 (0204)</b>	0.50 (0.020)	1.00 (0.039)	0.20 (0.008)
<b>LG22 (0306)</b>	0.65 (0.026)	1.50 (0.059)	0.20 (0.008)

# LGA Low Inductance Capacitors



## 0204/0306 Land Grid Array – Tin/Lead Termination “B”

SIZE	PG12 (0204)						PG22 (0306)								
Length mm (in.)	0.50 (0.020)						0.76 (0.030)								
Width mm (in.)	1.00 (0.039)						1.60 (0.063)								
Temp. Char.	X5R (D)		X7S (Z)		X6S (W)		X7R (C)		X5R (D)		X7S (Z)		X6S (W)		
Working Voltage	6.3 (6)	4 (4)	6.3 (6)	4 (4)	6.3 (6)	4 (4)	10 (Z)	6.3 (6)	4 (4)	6.3 (6)	4 (4)	6.3 (6)	4 (4)	6.3 (6)	4 (4)
Cap (µF)	0.010 (103)														
	0.022 (223)														
	0.047 (473)														
	0.100 (104)														
	0.220 (224)														
	0.330 (334)														
	0.470 (474)														
	1.000 (105)														
	2.200 (225)														

= X7R  
  = X5R  
  = X7S  
  = X6S

### HOW TO ORDER

<b>PG</b>	<b>1</b>	<b>2</b>	<b>6</b>	<b>Z</b>	<b>104</b>	<b>M</b>	<b>A</b>	<b>B</b>	<b>2</b>	<b>S</b>	<b>1</b>
Style	Case Size	Number of Terminals	Working Voltage	Temperature Characteristic	Coded Cap	Cap Tolerance	Termination Style	Termination 5% Min Lead	Packaging Tape & Reel	Thickness	Number of Capacitors
	1 = 0204 2 = 0306	2	4=4V 6=6.3V Z=10V	C = X7R D = X5R Z = X7S W = X6S		M = ±20%	A = "U" Land		2 = 7" Reel 4 = 13" Reel	S = 0.55mm max	

**\*Not RoHS Compliant**



### PART DIMENSIONS

### MM (INCHES)

Series	L	W	T	BW	BL
<b>PG12 (0204)</b>	0.5 ± 0.05 (0.020 ± 0.002)	1.00 ± 0.10 (0.039 ± 0.004)	0.50 ± 0.05 (0.020 ± 0.002)	0.8 ± 0.10 (0.031 ± 0.004)	0.13 ± 0.08 (0.005 ± 0.003)
<b>PG22 (0306)</b>	0.76 ± 0.10 (0.030 ± 0.004)	1.60 ± 0.10 (0.063 ± 0.004)	0.50 ± 0.05 (0.020 ± 0.002)	1.50 ± 0.10 (0.059 ± 0.004)	0.28 ± 0.08 (0.011 ± 0.003)

### RECOMMENDED SOLDER PAD DIMENSIONS

### MM (INCHES)

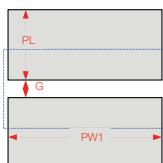

Series	PL	PW1	G
<b>PG12 (0204)</b>	0.50 (0.020)	1.00 (0.039)	0.20 (0.008)
<b>PG22 (0306)</b>	0.65 (0.026)	1.50 (0.059)	0.20 (0.008)

# High Temperature MLCCs

## AT Series – 200°C & 250°C Rated



Present military specifications, as well as a majority of commercial applications, require a maximum operating temperature of 125°C. However, the emerging market for high temperature electronics demands capacitors operating reliably at temperatures beyond 125°C. AVX's high temperature chip capacitor product line, has been extended with the BME COG chip. All AT chips have verified capabilities of long term operation up to 250°C for applications in both military and commercial businesses. These capacitors demonstrate high volumetric efficiency, high insulation resistance and low ESR/ESL for the most demanding applications, such as "down-hole" oil exploration and aerospace programs.

### HOW TO ORDER

AT10	3	T	104	K	A	T	2	A
AVX Style	Voltage Code	Temperature Coefficient	Capacitance Code (2 significant digits + no. of zeros)	Capacitance Tolerance	Test Level	Termination	Packaging	Special Code
AT03 = 0603	16V = Y	<b>PME</b>	101 = 100pF	J = ±5%	A = Standard	1 = Pd/Ag	2 = 7" Reel	A = Standard
AT05 = 0805	25V = 3	COG 250°C = A	102 = 1nF	K = ±10%		T = 100% Sn Plated (RoHS Compliant)	4 = 13" Reel	
AT06 = 1206	50V = 5	COG 200°C = 2	103 = 10nF	M = ±20%		7 = Ni/Au Plated (For 250°C BME COG Only)	9 = Bulk	
AT10 = 1210		VHT 250°C = T	104 = 100nF					
AT12 = 1812		VHT 200°C = 4	105 = 1µF					
AT14 = 2225		<b>BME</b>						
		COG 250°C = 5						
		COG 200°C = 3						

### ELECTRICAL SPECIFICATIONS

#### Temperature Coefficient

PME COG 0±30ppm/°C, -55C to 250°C

BME COG 0±30ppm/°C, -55C to 200°C

See TCC Plot for +250°C

VHT: T ±15%, -55°C to +150°C

See TCC Plot for +250°C

#### Capacitance Test (MIL-STD-202, Method 305)

25°C, 1.0 ± 0.2 Vrms (open circuit voltage) @ 1kHz

#### Dissipation factor 25°C

COG: 0.15% Max at 1.0 ± 0.2 Vrms (open circuit voltage) @ 1kHz

VHT: 2.5% Max at 1.0 ± 0.2 Vrms (open circuit voltage) @ 1kHz

#### Insulation Resistance 25°C (MIL-STD-202, Method 302)

100GΩ or 1000MΩ-µF (whichever is less)

#### Insulation Resistance 125°C (MIL-STD-202, Method 302)

10GΩ or 100MΩ-µF (whichever is less)

#### Insulation Resistance 200°C (MIL-STD-202, Method 302)

1GΩ or 10MΩ-µF (whichever is less)

#### Insulation Resistance 250°C (MIL-STD-202, Method 302)

100MΩ or 1MΩ-µF (whichever is less)

#### Direct Withstanding Voltage 25°C (Flash Test)

250% rated voltage for 5 seconds with 50mA max charging current

### DIMENSIONS



### MILLIMETERS (INCHES)

Size	AT03 = 0603	AT05= 0805	AT06=1206	AT10=1210	AT12=1812	AT14=2225
(L) Length	1.60 ± 0.15 (0.063 ± 0.006)	2.01 ± 0.20 (0.079 ± 0.008)	3.20 ± 0.20 (0.126 ± 0.008)	3.20 ± 0.20 (0.126 ± 0.008)	4.50 ± 0.30 (0.177 ± 0.012)	5.72 ± 0.25 (0.225 ± 0.010)
(W) Width	0.81 ± 0.15 (0.032 ± 0.006)	1.25 ± 0.20 (0.049 ± 0.008)	1.60 ± 0.20 (0.063 ± 0.008)	2.50 ± 0.20 (0.098 ± 0.008)	3.20 ± 0.20 (0.126 ± 0.008)	6.35 ± 0.25 (0.250 ± 0.010)
(T) Thickness Max.	1.02 (0.040)	1.30 (0.051)	1.52 (0.060)	1.70 (0.067)	2.54 (0.100)	2.54 (0.100)
(t) terminal	min. 0.25 (0.010) max. 0.75 (0.030)	min. 0.25 (0.010) max. 0.75 (0.030)	min. 0.25 (0.010) max. 0.75 (0.030)	min. 0.25 (0.010) max. 0.75 (0.030)	min. 0.25 (0.010) max. 1.02 (0.040)	min. 0.25 (0.010) max. 1.02 (0.040)

# High Temperature MLCC

## AT Series – 200°C & 250°C Rated



### PERFORMANCE CHARACTERISTICS

Typical Temperature Coefficient of Capacitance (VHT Dielectric)



Typical Temperature Coefficient of Capacitance (COG Dielectric)



Typical Voltage Coefficient of Capacitance (VHT Dielectric)



Typical Voltage Coefficient of Capacitance (COG Dielectric)

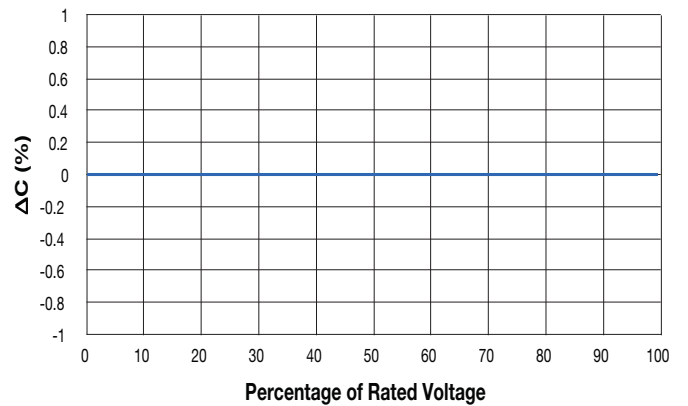

Typical RC vs Temperature (VHT Dielectric)

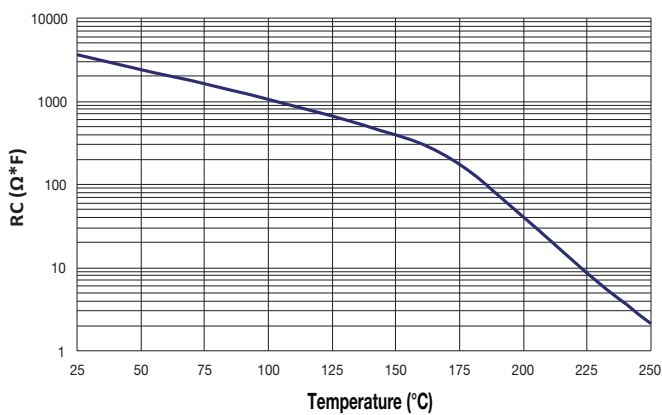

Typical RC vs Temperature (COG Dielectric)

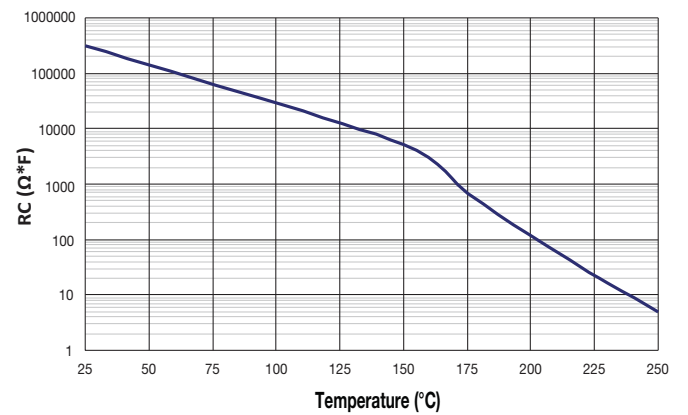

# High Temperature MLCC

## AT Series – 200°C & 250°C Rated



### RELIABILITY

250°C Life Test @ 2x Rated Voltage (VHT Dielectric)



250°C Life Test @ 2x Rated Voltage (COG Dielectric)

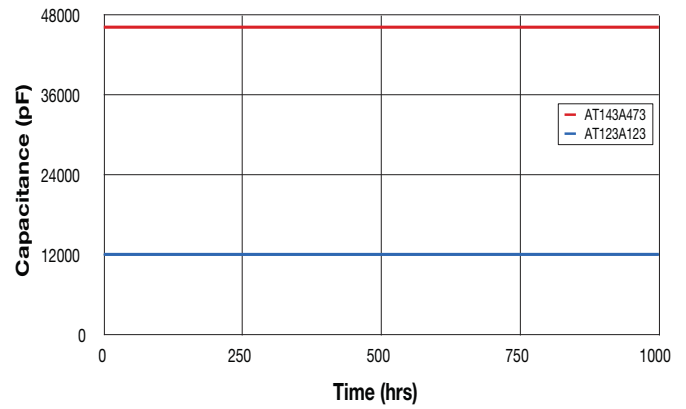

VHT - Failure Rate @ 90% Confidence Level (%/1000 hours)		
Temperature (°C)	50% Rated Voltage	100% Rated Voltage
200	0.002	0.017
250	0.026	0.210

\*Typical 1210, 1812, 2225 Failure Rate Analysis based on 250°C testing and voltage ratings specified on the following page.

COG - Failure Rate @ 90% Confidence Level (%/1000 hours)		
Temperature (°C)	50% Rated Voltage	100% Rated Voltage
200	0.006	0.047
250	0.074	0.590

\*Typical 1812 and 2225 Failure Rate Analysis based on 250°C testing and voltage ratings specified on the following page.

### FREQUENCY RESPONSE

Impedance Frequency Response (VHT Dielectric)



Impedance Frequency Response (COG Dielectric)



ESR Frequency Response (VHT Dielectric)

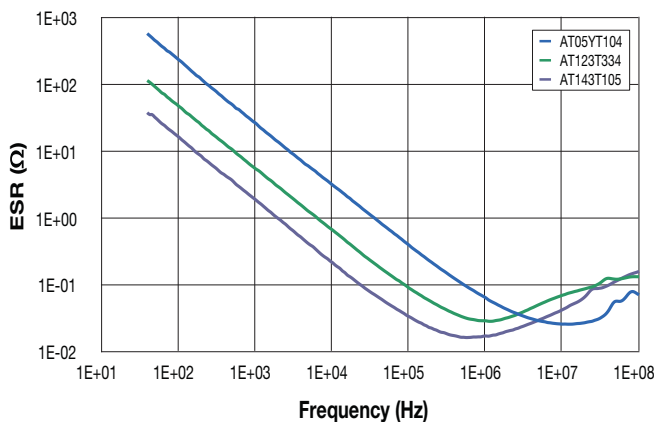

ESR Frequency Response (COG Dielectric)



# High Temperature MLCC

## AT Series – 200°C & 250°C Rated



### CAPACITANCE RANGE

### PREFERRED SIZES ARE SHADED

**VHT** Temp. Coefficient: 4 200°C Rated

Case Size	AT03 = 0603	AT05 = 0805	AT06 = 1206	AT10 = 1210	AT12 = 1812	AT14 = 2225
<b>Soldering</b>	Reflow/Wave	Reflow/Wave	Reflow/Wave	Reflow Only	Reflow Only	Reflow Only
(L) Length	mm 1.60±0.15 (in.) (0.063±0.006)	2.01±0.20 (0.079±0.008)	3.20±0.20 (0.126±0.008)	3.20±0.20 (0.126±0.008)	4.50±0.30 (0.177±0.012)	5.72±0.25 (0.225±0.010)
(W) Width	mm 0.81±0.15 (in.) (0.032±0.006)	1.25±0.20 (0.049±0.008)	1.60±0.20 (0.063±0.008)	2.50±0.20 (0.098±0.008)	3.20±0.20 (0.126±0.008)	6.35±0.25 (0.250±0.010)
(T) Thickness	mm 1.02 (in.) (0.040)	1.30 (0.051)	1.52 (0.060)	1.70 (0.067)	2.54 (0.100)	2.54 (0.100)
(t) Terminal	min 0.25(0.010) max 0.75(0.030)	0.25(0.010) 0.75(0.030)	0.25(0.010) 0.75(0.030)	0.25(0.010) 0.75(0.030)	0.25(0.010) 1.02(0.040)	0.25(0.010) 1.02(0.040)
<b>Rated Temp. (°C)</b>	200	200	200	200	200	200
<b>Temp. Coefficient</b>	4	4	4	4	4	4
<b>Voltage (V)</b>	25	25 50	25 50	25 50	50	50
Cap (pF)	1000 102					
	1200 122					
	1500 152					
	1800 182					
	2200 222					
	2700 272					
	3300 332					
	3900 392					
	4700 472					
	5600 562					
	6800 682					
	8200 822					
Cap (µF)	0.010 103					
	0.012 123					
	0.015 153					
	0.018 183					
	0.022 223					
	0.027 273					
	0.033 333					
	0.039 393					
	0.047 473					
	0.056 563					
	0.068 683					
	0.082 823					
	0.100 104					
	0.120 124					
	0.150 154					
	0.180 184					
	0.220 224					
	0.270 274					
	0.330 334					
	0.390 394					
	0.470 474					
	0.560 564					
	0.680 684					
	0.820 824					
	1.000 105					
<b>Voltage (V)</b>	25	25 50	25 50	25 50	50	50
<b>Rated Temp. (°C)</b>	200	200	200	200	200	200
<b>Case Size</b>	AT03 = 0603	AT05 = 0805	AT06 = 1206	AT10 = 1210	AT12 = 1812	AT14 = 2225

**VHT** Temp. Coefficient: T 250°C Rated

Case Size	AT03 = 0603	AT05 = 0805	AT06 = 1206	AT10 = 1210	AT12 = 1812	AT14 = 2225
<b>Soldering</b>	Reflow/Wave	Reflow/Wave	Reflow/Wave	Reflow Only	Reflow Only	Reflow Only
(L) Length	mm 1.60±0.15 (in.) (0.063±0.006)	2.01±0.20 (0.079±0.008)	3.20±0.20 (0.126±0.008)	3.20±0.20 (0.126±0.008)	4.50±0.30 (0.177±0.012)	5.72±0.25 (0.225±0.010)
(W) Width	mm 0.81±0.15 (in.) (0.032±0.006)	1.25±0.20 (0.049±0.008)	1.60±0.20 (0.063±0.008)	2.50±0.20 (0.098±0.008)	3.20±0.20 (0.126±0.008)	6.35±0.25 (0.250±0.010)
(T) Thickness	mm 1.02 (in.) (0.040)	1.30 (0.051)	1.52 (0.060)	1.70 (0.067)	2.54 (0.100)	2.54 (0.100)
(t) Terminal	min 0.25(0.010) max 0.75(0.030)	0.25(0.010) 0.75(0.030)	0.25(0.010) 0.75(0.030)	0.25(0.010) 0.75(0.030)	0.25(0.010) 1.02(0.040)	0.25(0.010) 1.02(0.040)
<b>Rated Temp. (°C)</b>	250	250	250	250	250	250
<b>Temp. Coefficient</b>	T	T	T	T	T	T
<b>Voltage (V)</b>	16	16 25	16 25	16 25	25	25
Cap (pF)	1000 102					
	1200 122					
	1500 152					
	1800 182					
	2200 222					
	2700 272					
	3300 332					
	3900 392					
	4700 472					
	5600 562					
	6800 682					
	8200 822					
Cap (µF)	0.010 103					
	0.012 123					
	0.015 153					
	0.018 183					
	0.022 223					
	0.027 273					
	0.033 333					
	0.039 393					
	0.047 473					
	0.056 563					
	0.068 683					
	0.082 823					
	0.100 104					
	0.120 124					
	0.150 154					
	0.180 184					
	0.220 224					
	0.270 274					
	0.330 334					
	0.390 394					
	0.470 474					
	0.560 564					
	0.680 684					
	0.820 824					
	1.000 105					
<b>Voltage (V)</b>	16	16 25	16 25	16 25	25	25
<b>Rated Temp. (°C)</b>	250	250	250	250	250	250
<b>Case Size</b>	AT03 = 0603	AT05 = 0805	AT06 = 1206	AT10 = 1210	AT12 = 1812	AT14 = 2225

Voltage rating per table. Capacitance values specified at 25°C, derate capacitance value based on TCC and VCC Plots on page 107.

NOTE: Contact factory for non-specified capacitance values.

# High Temperature MLCC

## AT Series – 200°C & 250°C Rated



### CAPACITANCE RANGE

### PREFERRED SIZES ARE SHADED

**BME COG** Temp. Coefficient: 4 200°C Rated

Case Size		AT03=0603		AT05=0805		AT06=1206	
Soldering		Reflow/Wave		Reflow/Wave		Reflow/Wave	
(L) Length	mm	1.60±0.15		2.01±0.20		3.20±0.20	
	(in.)	(0.063±0.006)		(0.079±0.008)		(0.126±0.008)	
(W) Width	mm	0.81±0.15		1.25±0.20		1.60±0.20	
	(in.)	(0.032±0.006)		(0.049±0.008)		(0.063±0.008)	
(T) Thickness	mm	1.02		1.30		1.52	
	(in.)	(0.040)		(0.051)		(0.060)	
(t) Terminal	min	0.25(0.010)		0.25(0.010)		0.25(0.010)	
	max	0.75(0.030)		0.75(0.030)		0.75(0.030)	
Rated Temp. (°C)		200		200		200	
Temp. Coefficient		3		3		3	
Voltage (V)		25	50	25	50	25	50
Cap (pF)	39	390					
	47	470					
	56	560					
	68	680					
	82	820					
	100	101					
	120	121					
	150	151					
	180	181					
	220	221					
	270	271					
	330	331					
	390	391					
	470	471					
	560	561					
	680	681					
	820	821					
	1000	102					
	1200	122					
	1500	152					
	1800	182					
	2200	222					
	2700	272					
	3300	332					
	3900	392					
	4700	472					
	5600	562					
	6800	682					
	8200	822					
Cap (µF)	0.010	103					
	0.012	123					
	0.015	153					
	0.018	183					
	0.022	223					
	0.027	273					
	0.033	333					
	0.039	393					
	0.047	473					
	0.056	563					
	0.068	683					
	0.082	823					
	0.100	104					
Voltage (V)		25	50	25	50	25	50
Rated Temp. (°C)		200	200	200	200	200	200
Case Size		AT03=0603		AT05=0805		AT06=1206	

**BME COG (Ni/Au)** Temp. Coefficient: 5 250°C Rated

Case Size		AT03=0603		AT05=0805		AT06 = 1206	
Soldering		Reflow/Wave		Reflow/Wave		Reflow/Wave	
(L) Length	mm	1.60±0.15		2.01±0.20		3.20±0.20	
	(in.)	(0.063±0.006)		(0.079±0.008)		(0.126±0.008)	
(W) Width	mm	0.81±0.15		1.25±0.20		1.60±0.20	
	(in.)	(0.032±0.006)		(0.049±0.008)		(0.063±0.008)	
(T) Thickness	mm	1.02		1.30		1.52	
	(in.)	(0.040)		(0.051)		(0.060)	
(t) Terminal	min	0.25(0.010)		0.25(0.010)		0.25(0.010)	
	max	0.75(0.030)		0.75(0.030)		0.75(0.030)	
Rated Temp. (°C)		250		250		250	
Temp. Coefficient		5		5		5	
Voltage (V)		25		25		25	
Cap (pF)	39	390					
	47	470					
	56	560					
	68	680					
	82	820					
	100	101					
	120	121					
	150	151					
	180	181					
	220	221					
	270	271					
	330	331					
	390	391					
	470	471					
	560	561					
	680	681					
	820	821					
	1000	102					
	1200	122					
	1500	152					
	1800	182					
	2200	222					
	2700	272					
	3300	332					
	3900	392					
	4700	472					
	5600	562					
	6800	682					
	8200	822					
Cap (µF)	0.010	103					
	0.012	123					
	0.015	153					
	0.018	183					
	0.022	223					
	0.027	273					
	0.033	333					
	0.039	393					
	0.047	473					
	0.056	563					
	0.068	683					
	0.082	823					
	0.100	104					
Voltage (V)		25		25		25	
Rated Temp. (°C)		250		250		250	
Case Size		AT03=0603		AT05=0805		AT06=1206	

Voltage rating per table. Capacitance values specified at 25°C, derate capacitance value based on TCC and VCC Plots on page 107.

NOTE: Contact factory for non-specified capacitance values.

# High Temperature MLCC

## AT Series – 200°C & 250°C Rated



### CAPACITANCE RANGE

### PREFERRED SIZES ARE SHADED

**PME COG** Temp. Coefficient: 2 200°C Rated

Case Size	AT05 = 0805	AT06 = 1206	AT10 = 1210	AT12 = 1812	AT14 = 2225
<b>Soldering</b>	Reflow/Wave	Reflow/Wave	Reflow Only	Reflow Only	Reflow Only
(L) Length	mm 2.01±0.20 (0.079±0.008)	3.20±0.20 (0.126±0.008)	3.20±0.20 (0.126±0.008)	4.50±0.30 (0.177±0.012)	2.75±0.25 (0.225±0.010)
(W) Width	mm 1.25±0.20 (0.049±0.008)	1.60±0.20 (0.063±0.008)	2.50±0.20 (0.098±0.008)	3.20±0.20 (0.126±0.008)	6.35±0.25 (0.250±0.010)
(T) Thickness	mm 1.30 (0.051)	1.52 (0.060)	1.70 (0.067)	2.54 (0.100)	2.54 (0.100)
(t) Terminal	min 0.25(0.010)	0.25(0.010)	0.25(0.010)	0.25(0.010)	0.25(0.010)
	max 0.75(0.030)	0.75(0.030)	0.75(0.030)	1.02(0.040)	1.02(0.040)
Rated Temp. (°C)	200	200	200	200	200
Temp. Coefficient	2	2	2	2	2
Voltage (V)	50	50	50	50	50
Cap (pF)	100 101				
	120 121				
	150 151				
	180 181				
	220 221				
	270 271				
	330 331				
	390 391				
	470 471				
	560 561				
	680 681				
	820 821				
	1000 102				
	1200 122				
	1500 152				
	1800 182				
	2200 222				
	2700 272				
3300 332					
3900 392					
4700 472					
5600 562					
6800 682					
8200 822					
Cap (µF)	0.010 103				
	0.012 123				
	0.015 153				
	0.018 183				
	0.022 223				
	0.027 273				
	0.033 333				
	0.039 393				
	0.047 473				
	0.056 563				
0.068 683					
0.082 823					
0.100 104					
Voltage (V)	50	50	50	50	50
Rated Temp. (°C)	200	200	200	200	200
Case Size	AT05 = 0805	AT06 = 1206	AT10 = 1210	AT12 = 1812	AT14 = 2225

**PME COG** Temp. Coefficient: A 250°C Rated

Case Size	AT05 = 0805	AT06 = 1206	AT10 = 1210	AT12 = 1812	AT14 = 2225
<b>Soldering</b>	Reflow/Wave	Reflow/Wave	Reflow Only	Reflow Only	Reflow Only
(L) Length	mm 2.01±0.20 (0.079±0.008)	3.20±0.20 (0.126±0.008)	3.20±0.20 (0.126±0.008)	4.50±0.30 (0.177±0.012)	2.75±0.25 (0.225±0.010)
(W) Width	mm 1.25±0.20 (0.049±0.008)	1.60±0.20 (0.063±0.008)	2.50±0.20 (0.098±0.008)	3.20±0.20 (0.126±0.008)	6.35±0.25 (0.250±0.010)
(T) Thickness	mm 1.30 (0.051)	1.52 (0.060)	1.70 (0.067)	2.54 (0.100)	2.54 (0.100)
(t) Terminal	min 0.25(0.010)	0.25(0.010)	0.25(0.010)	0.25(0.010)	0.25(0.010)
	max 0.75(0.030)	0.75(0.030)	0.75(0.030)	1.02(0.040)	1.02(0.040)
Rated Temp. (°C)	250	250	250	250	250
Temp. Coefficient	A	A	A	A	A
Voltage (V)	25	25	25	25	25
Cap (pF)	100 101				
	120 121				
	150 151				
	180 181				
	220 221				
	270 271				
	330 331				
	390 391				
	470 471				
	560 561				
	680 681				
	820 821				
	1000 102				
	1200 122				
	1500 152				
	1800 182				
	2200 222				
	2700 272				
3300 332					
3900 392					
4700 472					
5600 562					
6800 682					
8200 822					
Cap (µF)	0.010 103				
	0.012 123				
	0.015 153				
	0.018 183				
	0.022 223				
	0.027 273				
	0.033 333				
	0.039 393				
	0.047 473				
	0.056 563				
0.068 683					
0.082 823					
0.100 104					
Voltage (V)	25	25	25	25	25
Rated Temp. (°C)	250	250	250	250	250
Case Size	AT05 = 0805	AT06 = 1206	AT10 = 1210	AT12 = 1812	AT14 = 2225

Voltage rating per table. Capacitance values specified at 25°C, derate capacitance value based on TCC and VCC Plots on page 107.

NOTE: Contact factory for non-specified capacitance values.

# High Voltage MLC Chips

## For 600V to 5000V Applications

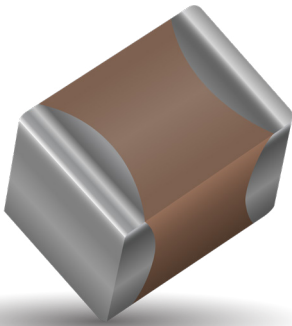

High value, low leakage and small size are difficult parameters to obtain in capacitors for high voltage systems. AVX special high voltage MLC chip capacitors meet these performance characteristics and are designed for applications such as snubbers in high frequency power converters, resonators in SMPS, and high voltage coupling/dc blocking. These high voltage chip designs exhibit low ESRs at high frequencies.

Larger physical sizes than normally encountered chips are used to make high voltage MLC chip products. Special precautions must be taken in applying these chips in surface mount assemblies. The temperature gradient during heating or cooling cycles should not exceed 4°C per second. The preheat temperature must be within 50°C of the peak temperature reached by the ceramic bodies through the soldering process. Chip sizes 1210 and larger should be reflow soldered only. Capacitors may require protective surface coating to prevent external arcing.

For 1825, 2225 and 3640 sizes, AVX offers leaded version in either thru-hole or SMT configurations (for details see section on high voltage leaded MLC chips)

### NEW 630V RANGE

## HOW TO ORDER

1808	A	A	271	M	A	1	2	A
<b>AVX Style</b>	<b>Voltage</b>	<b>Temperature Coefficient</b>	<b>Capacitance Code</b> (2 significant digits + no. of zeros) Examples:	<b>Capacitance Tolerance</b> COG: J = ±5% K = ±10% M = ±20% X7R: K = ±10% M = ±20% Z = +80%, -20%	<b>Test Level</b> A = Standard	<b>Termination*</b> 1 = Pd/Ag T = Plated Ni and Sn (RoHS Compliant)	<b>Packaging**</b> 1 or 2 = 7" Reel 3 or 4 = 13" Reel	<b>Special Code</b> A = Standard
0805	600V/630V = C	NPO (COG) = A X7R = C	10 pF = 100 100 pF = 101 1,000 pF = 102 22,000 pF = 223 220,000 pF = 224 1 μF = 105					
1206	1000V = A							
1210	1500V = S							
1808	2000V = G							
1812	2500V = W							
1825	3000V = H							
2220	4000V = J							
2225	5000V = K							
3640								

\*Note: Terminations with 5% minimum lead (Pb) is available, see pages 100 and 101 for LD style. Leaded terminations are available, see pages 102-106.

Notes: Capacitors with X7R dielectrics are not intended for applications across AC supply mains or AC line filtering with polarity reversal. Contact plant for recommendations. Contact factory for availability of Termination and Tolerance options for Specific Part Numbers.

\*\*The 3640 Style is not available on 7" Reels.

\*\*\* AVX offers nonstandard chip sizes. Contact factory for details.

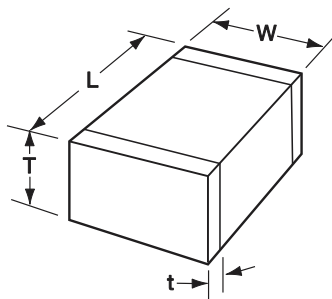

## DIMENSIONS

## MILLIMETERS (INCHES)

SIZE	0805	1206	1210*	1808*	1812*	1825*	2220*	2225*	3640*
(L) Length	2.10 ± 0.20 (0.083 ± 0.008)	3.30 ± 0.30 (0.130 ± 0.012)	3.30 ± 0.40 (0.130 ± 0.016)	4.60 ± 0.50 (0.181 ± 0.020)	4.60 ± 0.50 (0.181 ± 0.020)	4.60 ± 0.50 (0.181 ± 0.020)	5.70 ± 0.50 (0.224 ± 0.020)	5.72 ± 0.25 (0.225 ± 0.010)	9.14 ± 0.25 (0.360 ± 0.010)
(W) Width	1.25 ± 0.20 (0.049 ± 0.008)	1.60 ± 0.20 (0.063 ± 0.008)	2.50 ± 0.30 (0.098 ± 0.012)	2.00 ± 0.20 (0.079 ± 0.008)	3.20 ± 0.30 (0.126 ± 0.012)	6.30 ± 0.40 (0.248 ± 0.016)	5.00 ± 0.40 (0.197 ± 0.016)	6.35 ± 0.25 (0.250 ± 0.010)	10.2 ± 0.25 (0.400 ± 0.010)
(T) Thickness Max.	1.35 (0.053)	1.80 (0.071)	2.80 (0.110)	2.20 (0.087)	2.80 (0.110)	3.40 (0.134)	3.40 (0.134)	2.54 (0.100)	2.54 (0.100)
(t) terminal min. max.	0.50 ± 0.20 (0.020 ± 0.008)	0.60 ± 0.20 (0.024 ± 0.008)	0.75 ± 0.35 (0.030 ± 0.014)	0.75 ± 0.35 (0.030 ± 0.014)	0.75 ± 0.35 (0.030 ± 0.014)	0.75 ± 0.35 (0.030 ± 0.014)	0.85 ± 0.35 (0.033 ± 0.014)	0.85 ± 0.35 (0.033 ± 0.014)	0.76 (0.030) 1.52 (0.060)

\*Reflow Soldering Only

# High Voltage MLC Chips

For 600V to 5000V Applications



## NPO (C0G) Dielectric Performance Characteristics

Capacitance Range	10 pF to 0.100 μF (25°C, 1.0 ±0.2 Vrms at 1kHz, for ≤ 1000 pF use 1 MHz)
Capacitance Tolerances	±5%, ±10%, ±20%
Dissipation Factor	0.1% max. (+25°C, 1.0 ±0.2 Vrms, 1kHz, for ≤ 1000 pF use 1 MHz)
Operating Temperature Range	-55°C to +125°C
Temperature Characteristic	0 ±30 ppm/°C (0 VDC)
Voltage Ratings	600, 630, 1000, 1500, 2000, 2500, 3000, 4000 & 5000 VDC (+125°C)
Insulation Resistance (+25°C, at 500 VDC)	100K MΩ min. or 1000 MΩ - μF min., whichever is less
Insulation Resistance (+125°C, at 500 VDC)	10K MΩ min. or 100 MΩ - μF min., whichever is less
Dielectric Strength	Minimum 120% rated voltage for 5 seconds at 50 mA max. current

## NPO (C0G) CAPACITANCE RANGE – PREFERRED SIZES ARE SHADED

Case Size Soldering	0805			1206				1210					1808					1812												
	Reflow/Wave	Reflow/Wave		Reflow/Wave				Reflow Only					Reflow Only					Reflow Only												
(L) Length	mm (in.)	mm (in.)		mm (in.)				mm (in.)					mm (in.)					mm (in.)												
(W) Width	mm (in.)	mm (in.)		mm (in.)				mm (in.)					mm (in.)					mm (in.)												
(T) Thickness	mm (in.)	mm (in.)		mm (in.)				mm (in.)					mm (in.)					mm (in.)												
(t) Terminal	mm (in.)	mm (in.)		mm (in.)				mm (in.)					mm (in.)					mm (in.)												
Voltage (V)	600	630	1000	600	630	1000	1500	2000	600	630	1000	1500	2000	3000	600	630	1000	1500	2000	2500	3000	4000	600	630	1000	1500	2000	2500	3000	4000
Cap (pF)	.5	OR5	A	C																										
	1.0	1R0	A	C																										
	1.2	1R2	A	C																										
	1.5	1R5	A	A	C	X	X	X	X	X	X																			
	1.8	1R8	A	A	C	X	X	X	X	X	X																			
	2.2	2R2	A	A	C	X	X	X	X	X	X																			
	2.7	2R7	A	A	C	X	X	X	X	X	X																			
	3.3	3R3	A	A	C	X	X	X	X	X	X																			
	3.9	3R9	A	A	C	X	X	X	X	X	X																			
	4.7	4R7	A	A	C	X	X	X	X	X	X																			
	5.6	5R6	A	A	C	X	X	X	X	X	X																			
	6.8	6R8	A	A	C	X	X	X	X	X	X																			
	8.2	8R2	A	A	C	X	X	X	X	X	X																			
	10	100	A	A	C	X	X	X	X	X	X	C	M	M	D	M	F	C	C	C	C	C	C	C	C	C	C	C	C	E
	12	120	A	A	C	X	X	X	X	X	X	C	M	M	D	M	F	C	C	C	C	C	C	C	C	C	C	C	C	E
	15	150	A	A	C	X	X	X	X	X	X	C	M	M	D	M	F	C	C	C	C	C	C	C	C	C	C	C	C	E
	18	180	A	A	C	X	X	X	X	X	X	C	M	M	D	M	F	C	C	C	C	C	C	C	C	C	C	C	C	E
	22	220	A	A	C	X	X	X	X	X	X	C	M	M	D	M	F	C	C	C	C	C	C	C	C	C	C	C	C	E
	27	270	A	A	C	X	X	X	X	X	X	C	M	M	D	M	F	C	C	C	C	C	C	C	C	C	C	C	C	E
	33	330	A	A	C	X	X	X	X	X	X	D	M	C	M	D	M	F	C	C	C	C	C	C	C	C	C	C	C	E
	39	390	A	A	C	X	X	X	X	X	X	D	M	C	M	D	M	F	C	C	C	C	C	C	C	C	C	C	C	E
	47	470	A	A	C	X	X	X	X	X	X	D	M	C	M	D	M	F	C	C	C	C	C	C	C	C	C	C	C	E
	56	560	A	A	C	X	X	X	X	X	X	D	M	C	M	D	M	F	C	C	C	C	C	C	C	C	C	C	C	E
	68	680	A	A	C	X	X	X	X	X	X	D	M	C	M	D	M	F	C	C	C	C	C	C	C	C	C	C	C	E
	82	820	X	X	X	X	X	X	X	X	X	C	C	C	C	C	C	C	C	C	C	C	C	C	C	C	C	C	C	E
	100	101	X	X	X	X	X	X	X	X	X	C	C	C	C	C	C	C	C	C	C	C	C	C	C	C	C	C	C	E
	120	121	C	C	C	X	X	X	X	X	X	C	E	E	E	C	M	C	C	C	C	C	C	C	C	C	C	C	C	G
	150	151	C	C	C	X	X	X	X	X	X	C	E	E	C	M	C	C	C	C	C	C	C	C	C	C	C	C	C	G
	180	181	C	C	C	X	X	X	X	X	X	C	E	E	C	M	C	C	C	C	C	C	C	C	C	C	C	C	C	G
	220	221	C	C	C	X	X	X	X	X	X	C	E	E	C	M	C	C	C	C	C	C	C	C	C	C	C	C	C	G
	270	271	C	C	C	X	X	X	X	X	X	C	E	E	C	M	C	C	C	C	C	C	C	C	C	C	C	C	C	G
	330	331	C	C	C	C	M	E	E	E	E	C	M	E	E	E	E	E	E	E	E	E	E	E	E	E	E	E	E	G
	390	391	C	C	C	C	M	E	E	E	E	C	M	E	E	E	E	E	E	E	E	E	E	E	E	E	E	E	E	G
	470	471	C	C	C	C	M	E	E	E	E	C	M	E	E	E	E	E	E	E	E	E	E	E	E	E	E	E	E	G
	560	561	C	C	C	C	C	E	E	E	E	C	M	E	E	E	E	E	E	E	E	E	E	E	E	E	E	E	E	G
	680	681	C	C	C	C	C	E	E	E	E	C	M	E	E	E	E	E	E	E	E	E	E	E	E	E	E	E	E	G
	750	751	C	C	C	C	C	E	E	E	E	C	M	E	E	E	E	E	E	E	E	E	E	E	E	E	E	E	E	G
	820	821	C	C	C	C	C	E	E	E	E	C	M	E	E	E	E	E	E	E	E	E	E	E	E	E	E	E	E	G
	1000	102	C	C	C	C	C	E	E	E	E	C	C	E	E	E	E	E	E	E	E	E	E	E	E	E	E	E	E	G
	1200	122	C	C	C	C	C	E	E	E	E	C	C	E	E	E	E	E	E	E	E	E	E	E	E	E	E	E	E	G
	1500	152	C	C	C	C	C	E	E	E	E	C	C	F	F	F	F	F	F	F	F	F	F	F	F	F	F	F	F	G
	1800	182	C	C	C	C	C	E	E	E	E	C	C	G	G	G	G	G	G	G	G	G	G	G	G	G	G	G	G	G
	2200	222	C	C	C	C	C	E	E	E	E	C	C	G	G	G	G	G	G	G	G	G	G	G	G	G	G	G	G	G
	2700	272	C	C	C	C	C	E	E	E	E	C	C	G	G	G	G	G	G	G	G	G	G	G	G	G	G	G	G	G
	3300	332	C	C	C	C	C	E	E	E	E	C	C	G	G	G	G	G	G	G	G	G	G	G	G	G	G	G	G	G
	3900	392	C	C	C	C	C	E	E	E	E	C	C	G	G	G	G	G	G	G	G	G	G	G	G	G	G	G	G	G
	4700	472	C	C	C	C	C	E	E	E	E	C	C	G	G	G	G	G	G	G	G	G	G	G	G	G	G	G	G	G
	5600	562	C	C	C	C	C	E	E	E	E	C	C	G	G	G	G	G	G	G	G	G	G	G	G	G	G	G	G	G
	6800	682	C	C	C	C	C	E	E	E	E	C	C	G	G	G	G	G	G	G	G	G	G	G	G	G	G	G	G	G
	8200	822	C	C	C	C	C	E	E	E	E	C	C	G	G	G	G	G	G	G	G	G	G	G	G	G	G	G	G	G
	0.010	103																												
	0.012	123																												
	0.015	153																												
	0.018	183																												
	0.022	223																												
	0.027	273																												
	0.033	333																												

# High Voltage MLC Chips

For 600V to 5000V Applications



## NPO (C0G) CAPACITANCE RANGE – PREFERRED SIZES ARE SHADED

Case Size	1825								2220								2225								3640										
Soldering	Reflow Only								Reflow Only								Reflow Only								Reflow Only										
(L) Length	4.60 ± 0.50 (0.181 ± 0.020)								5.70 ± 0.50 (0.224 ± 0.020)								5.70 ± 0.50 (0.225 ± 0.010)								9.14 ± 0.25 (0.360 ± 0.010)										
(W) Width	6.30 ± 0.40 (0.248 ± 0.016)								5.00 ± 0.40 (0.197 ± 0.016)								6.30 ± 0.40 (0.250 ± 0.010)								10.2 ± 0.25 (0.400 ± 0.010)										
(T) Thickness	3.40 (0.134)								3.40 (0.134)								3.40 (0.100)								2.54 (0.100)										
(t) Terminal	0.75 ± 0.35 (0.030 ± 0.014)								0.85 ± 0.35 (0.033 ± 0.014)								0.85 ± 0.35 (0.033 ± 0.014)								0.76 (0.030) 1.52 (0.060)										
Voltage (V)	600	630	1000	1500	2000	2500	3000	4000	600	630	1000	1500	2000	2500	3000	4000	5000	600	630	1000	1500	2000	2500	3000	4000	5000	600	630	1000	1500	2000	2500	3000	4000	5000
Cap (pF)	1.5	1R5							1.5	1R5								1.5	1R5								1.5	1R5							
	1.8	1R8							1.8	1R8								1.8	1R8								1.8	1R8							
	2.2	2R2							2.2	2R2								2.2	2R2								2.2	2R2							
	2.7	2R7							2.7	2R7								2.7	2R7								2.7	2R7							
	3.3	3R3							3.3	3R3								3.3	3R3								3.3	3R3							
	3.9	3R9							3.9	3R9								3.9	3R9								3.9	3R9							
	4.7	4R7							4.7	4R7								4.7	4R7								4.7	4R7							
	5.6	5R6							5.6	5R6								5.6	5R6								5.6	5R6							
	6.8	6R8							6.8	6R8								6.8	6R8								6.8	6R8							
	8.2	8R2							8.2	8R2								8.2	8R2								8.2	8R2							
	10	100	E	E	G	E	F	E	F	F	E	E	E	E	E	E	E	E	E	E	E	E	E	E	E	F	F								
	12	120	E	E	G	E	F	E	F	F	F	E	E	E	E	E	E	E	E	E	E	E	E	E	E	F	F								
	15	150	E	E	G	E	F	E	F	F	F	E	E	E	E	E	E	E	E	E	E	E	E	E	E	F	F								
	18	180	E	E	G	E	F	E	F	F	F	E	E	E	E	E	E	E	E	E	E	E	E	E	E	F	F								
	22	220	E	E	G	E	F	E	F	F	F	E	E	E	E	E	E	E	E	E	E	E	E	E	E	F	F								
	27	270	E	E	G	E	F	E	F	F	F	E	E	E	E	E	E	E	E	E	E	E	E	E	E	F	F								
	33	330	E	E	G	E	F	E	F	F	F	E	E	E	E	E	E	E	E	E	E	E	E	E	E	F	F								
	39	390	E	E	G	E	F	E	F	F	F	E	E	E	E	E	E	E	E	E	E	E	E	E	E	F	F								
	47	470	E	E	G	E	F	E	F	F	F	E	E	E	E	E	E	E	E	E	E	E	E	E	E	F	F								
	56	560	E	E	G	E	F	E	F	F	F	E	E	E	E	E	E	E	E	E	E	E	E	E	E	F	F								
	68	680	E	E	G	E	F	E	F	F	F	E	E	E	E	E	E	E	E	E	E	E	E	E	E	F	F								
	82	820	E	E	G	E	F	E	F	F	F	E	E	E	E	E	E	E	E	E	E	E	E	E	E	F	F								
	100	101	E	E	G	E	F	E	F	F	F	E	E	E	E	E	E	E	E	E	E	E	E	E	G	G									
	120	121	E	E	G	E	F	E	F	F	F	E	E	E	E	E	E	E	E	E	E	E	E	E	G	G									
	150	151	E	E	G	E	F	E	F	F	F	E	E	E	E	E	E	E	E	E	E	E	E	E	G	G									
	180	181	E	E	G	E	F	E	F	F	F	E	E	E	E	E	E	E	E	E	E	E	E	E	G	G									
	220	221	E	E	G	E	F	E	F	F	F	E	E	E	E	E	E	E	E	E	E	E	E	E	G	G									
	270	271	E	E	G	E	F	E	F	F	F	E	E	E	E	E	E	E	E	E	E	E	E	E	G	G									
	330	331	E	E	G	E	F	E	F	F	F	E	E	E	E	E	E	E	E	E	E	E	E	E	G	G									
	390	391	E	E	G	E	F	E	F	F	F	E	E	E	E	E	E	E	E	E	E	E	E	E	G	G									
	470	471	E	E	G	E	F	E	F	F	F	E	E	E	E	E	E	E	E	E	E	E	E	E	G	G									
	560	561	E	E	G	E	F	E	F	F	F	E	E	E	E	E	E	E	E	E	E	E	E	E	G	G									
	680	681	E	E	G	E	F	F	G			E	E	E	E	E	F	F						E	E	E	E	E	E	E	E	E			
	750	751	E	E	G	E	F	F	G			E	E	E	E	E	F	F						E	E	E	E	E	E	E	E	E			
	820	821	E	E	G	E	F	F	G			E	E	E	E	E	F	F						E	E	E	E	E	E	E	E	E			
	1000	102	E	E	G	E	F	F	G			E	E	E	E	E	F	F						E	E	E	E	E	E	E	E	E			
	1200	122	E	E	G	E	F	G	G			E	E	E	E	E	G	G						E	E	E	E	E	F	F					
	1500	152	E	E	G	F	G	G	G			E	E	E	E	F	F	G	G					E	E	E	E	E	F	F					
	1800	182	E	E	G	F	G	G	G			E	E	E	F	F	G	G						E	E	E	E	E	G	G					
	2200	222	E	E	G	G	G		G			E	E	E	G	G								E	E	E	E	E							
	2700	272	E	E	G	G		G			E	E	E	G	G									E	E	E	F	F							
	3300	332	E	E	G	G		G			E	E	E	G	G									E	E	E	F	F							
	3900	392	E	E	G	G		G			E	E	E	G	G									E	E	E	G	G							
	4700	472	E	E	G	G		G			E	E	E	G	G									E	E	E	G	G							
	5600	562	F	F	G	G		G			F	F	F	G	G									F	F	F	G	G							
	6800	682	F	F	G		G				F	F	F	G	G									F	F	F	G	G							
	8200	822	G	G	G		G				G	G	G											G	G	G									
	Cap (µF)	0.010	103	F	E	G					7	7	7											G	G	G									
		0.012	123	E	G																			G	G	G									
		0.015	153	E																				G	G										
		0.018	183	E																				G	G	G									
		0.022	223	E																				G	G										
		0.027	227	F																															
		0.033	333	F																				G	G										
		0.039	393	G																															
		0.047	473	G																															
		0.056	563	G																															
		0.068	683	G																															
		0.100	104																																
Voltage (V)	600	630	1000	1500	2000	2500	3000	4000	600	630	1000	1500	2000	2500	3000	4000	5000	600	630	1000	1500	2000	2500	3000	4000	5000	600	630	1000	1500	2000	2500	3000	4000	5000
Case Size	1825								2220								2225								3640										

Letter	A	C	E	F	G	X	7
Max. Thickness	0.813 (0.032)	1.448 (0.057)	1.8034 (0.071)	2.2098 (0.087)	2.794 (0.110)	0.940 (0.037)	3.30 (0.130)

NOTE: Contact factory for non-specified capacitance values

# High Voltage MLC Chips

## For 600V to 5000V Applications



### X7R Dielectric

#### Performance Characteristics

Capacitance Range	10 pF to 0.82 μF (25°C, 1.0 ±0.2 Vrms at 1kHz)
Capacitance Tolerances	±10%; ±20%; +80%, -20%
Dissipation Factor	2.5% max. (+25°C, 1.0 ±0.2 Vrms, 1kHz)
Operating Temperature Range	-55°C to +125°C
Temperature Characteristic	±15% (0 VDC)
Voltage Ratings	600, 630, 1000, 1500, 2000, 2500, 3000, 4000 & 5000 VDC (+125°C)
Insulation Resistance (+25°C, at 500 VDC)	100K MΩ min. or 1000 MΩ - μF min., whichever is less
Insulation Resistance (+125°C, at 500 VDC)	10K MΩ min. or 100 MΩ - μF min., whichever is less
Dielectric Strength	Minimum 120% rated voltage for 5 seconds at 50 mA max. current

### NPO (C0G) CAPACITANCE RANGE – PREFERRED SIZES ARE SHADED

Case Size	0805							1206							1210							1808							1812						
	Reflow/Wave							Reflow/Wave							Reflow Only							Reflow Only							Reflow Only						
(L) Length	2.10 0.20 (0.085 ± 0.008)							3.30 ± 0.30 (0.130 ± 0.012)							3.30 0.40 (0.130 0.016)							4.60 ± 0.50 (0.181 ± 0.020)							4.60 ± 0.50 (0.177 ± 0.012)						
(W) Width	1.25 ± 0.20 (0.049 ± 0.008)							1.60 +0.30/-0.10 (0.063 +0.012/-0.004)							2.50 0.30 (0.098 0.012)							2.00 0.20 (0.079 ± 0.008)							3.20 ± 0.30 (0.126 ± 0.008)						
(T) Thickness	1.35 (0.053)							1.80 (0.071)							2.80 (0.110)							2.20 (0.087)							2.80 (0.100)						
(t) Terminal max	0.50 ± 0.20 (0.020 ± 0.008)							0.60 ± 0.20 (0.024 ± 0.008)							0.75 0.35 (0.030 ± 0.014)							0.75 ± 0.35 (0.030 ± 0.014)							0.75 ± 0.35 (0.030 ± 0.014)						
Voltage (V)	600	630	1000	600	630	1000	1500	2000	600	630	1000	1500	2000	600	630	1000	1500	2000	2500	3000	4000	600	630	1000	1500	2000	2500	3000	4000						
Cap (pF) 100	X	X	C	C	C	C	E	E	E	E	E	E	E	E	E	E	E	E	E	E	F	E	E	E	E	E	E	E							
120	X	X	C	C	C	C	E	E	E	E	E	E	E	E	E	E	E	E	E	E	F	E	E	E	E	E	E	E							
150	X	X	C	C	C	C	E	E	E	E	E	E	E	E	E	E	E	E	E	E	F	E	E	E	E	E	E	E							
180	X	X	C	C	C	C	E	E	E	E	E	E	E	E	E	E	E	E	E	E	F	E	E	E	E	E	E	E							
220	X	X	C	C	C	C	E	E	E	E	E	E	E	E	E	E	E	E	E	E	F	E	E	E	E	E	E	E							
270	X	X	C	C	C	C	E	E	E	E	E	E	E	E	E	E	E	E	E	E	F	E	E	E	E	E	E	E							
330	X	X	C	C	C	C	E	E	E	E	E	E	E	E	E	E	E	E	E	E	F	E	E	E	E	E	E	E							
390	X	X	C	C	C	C	E	E	E	E	E	E	E	E	E	E	E	E	E	E	F	E	E	E	E	E	E	E							
470	X	X	C	C	C	C	E	E	E	E	E	E	E	E	E	E	E	E	E	E	F	E	E	E	E	E	E	E							
560	X	X	C	C	C	C	E	E	E	E	E	E	E	E	E	E	E	E	E	E	F	E	E	E	E	E	E	E							
680	X	X	C	C	C	C	E	E	E	E	E	E	E	E	E	E	E	E	E	E	F	E	E	E	E	E	E	E							
750	X	X	C	C	C	C	E	E	E	E	E	E	E	E	E	E	E	E	E	E	F	E	E	E	E	E	E	E							
820	X	X	C	C	C	C	E	E	E	E	E	E	E	E	E	E	E	E	E	E	F	E	E	E	E	E	E	E							
1000	X	X	X	C	C	C	E	E	E	E	E	E	E	E	E	E	E	E	E	E	F	E	E	E	E	E	E	E							
1200	X	X	X	C	C	C	E	E	E	E	E	E	E	E	E	E	E	E	E	E	F	E	E	E	E	E	E	E							
1500	X	X	X	C	C	C	E	E	E	E	E	E	E	E	E	E	E	E	E	E	F	E	E	E	E	E	E	E							
1800	X	X	X	C	C	C	E	E	E	E	E	E	E	E	E	E	E	E	E	E	F	E	E	E	E	E	E	E							
2200	X	X	X	C	C	C	E	E	E	E	E	E	E	E	E	E	E	E	E	E	F	E	E	E	E	E	E	E							
2700	C	C		C	C	E	E		E	E	E	F	E	E	E	E	F	F				E	E	E	E	E	G	G							
3300	C	C		C	C	E			E	E	E	F	E	E	E	E	F	F				E	E	E	F	F	G	G							
3900	C	C		C	C	E			E	E	E	F										E	E	E	F	F	G	G							
4700	C	C		C	C	E			E	E	E	F										E	E	E	F	F	G	G							
5600	C	C		C	C	E			E	E	E	F										E	E	E	G	G	G								
6800	C	C		C	C	E			E	E	E											E	E	E	G	G									
8200	C	C		C	C	E			E	E	E											E	E	E	G	G									
Cap (μF) 0.010	C	C		C	C	E			E	E	E											E	E	F	G	G									
0.015	C	C		E	E	E			E	E	E											F	F	F											
0.018	C	C		E	E				E	E	E											F	F	F											
0.022	C	C		E	E				E	E	F											F	F												
0.027				E	E				E	E												F	F												
0.033				E	E				E	E												F	F												
0.039									E	E												F	F												
0.047									E	E												F	F												
0.056									F	F												F	F												
0.068									F	F												F	F												
0.082									F	F												F	F												
0.100									F	F												F	F												
0.150																																			
0.220																																			
0.270																																			
0.330																																			
0.390																																			
0.470																																			
0.560																																			
0.680																																			
0.820																																			
1.000																																			
Voltage (V)	600	630	1000	600	630	1000	1500	2000	600	630	1000	1500	2000	600	630	1000	1500	2000	2500	3000	4000	600	630	1000	1500	2000	2500	3000	4000						
Case Size	0805							1206							1210							1808							1812						

Letter	A	C	E	F	G	X	7
Max. Thickness	0.813 (0.032)	1.448 (0.057)	1.8034 (0.071)	2.2098 (0.087)	2.794 (0.110)	0.940 (0.037)	3.30 (0.130)

NOTE: Contact factory for non-specified capacitance values



# High Voltage MLC Chips

For 600V to 5000V Applications



## X7R CAPACITANCE RANGE PREFERRED SIZES ARE SHADED

Case Size	1825								2220								2225								3640										
Soldering	Reflow Only								Reflow Only								Reflow Only								Reflow Only										
(L) Length	4.60 ± 0.50 (0.181 ± 0.020)								5.70 ± 0.50 (0.224 ± 0.020)								5.70 ± 0.50 (0.225 ± 0.010)								9.14 ± 0.25 (0.360 ± 0.010)										
(W) Width	6.30 ± 0.40 (0.248 ± 0.016)								5.00 ± 0.40 (0.197 ± 0.016)								6.30 ± 0.40 (0.250 ± 0.010)								10.2 ± 0.25 (0.400 ± 0.010)										
(T) Thickness	3.40 (0.134)								3.40 (0.134)								3.40 (0.100)								2.54 (0.100)										
(t) Terminal	0.75 ± 0.35 (0.030 ± 0.014)								0.85 ± 0.35 (0.033 ± 0.014)								0.85 ± 0.35 (0.033 ± 0.014)								0.76 (0.030) 1.52 (0.060)										
Voltage (V)	600	630	1000	1500	2000	2500	3000	4000	600	630	1000	1500	2000	2500	3000	4000	5000	600	630	1000	1500	2000	2500	3000	4000	5000	600	630	1000	1500	2000	2500	3000	4000	5000
Cap (pF)	100	101																																	
120	121																																		
150	151																																		
180	181																																		
220	221																																		
270	271																																		
330	331																																		
390	391																																		
470	471																																		
560	561																																		
680	681																																		
750	751																																		
820	821																																		
1000	102	F	F	F	F	F	F	F	F	F	F	F	F	F	F	G	F	F	F	F	F	F	F	F	F	G	G	G	G	G	G	G	G	G	
1200	122	F	F	F	F	F	F	F	F	F	F	F	F	F	F	G	F	F	F	F	F	F	F	F	F	G	G	G	G	G	G	G	G	G	
1500	152	F	F	F	F	F	F	F	F	F	F	F	F	F	F	G	F	F	F	F	F	F	F	F	F	G	G	G	G	G	G	G	G	G	
1800	182	F	F	F	F	F	F	F	F	F	F	F	F	F	F	G	F	F	F	F	F	F	F	F	F	G	G	G	G	G	G	G	G	G	
2200	222	F	F	F	F	F	F	F	F	F	F	F	F	F	F	G	F	F	F	F	F	F	F	F	F	G	G	G	G	G	G	G	G	G	
2700	272	F	F	F	F	F	F	F	F	F	F	F	F	F	F	G	F	F	F	F	F	F	F	F	F	G	G	G	G	G	G	G	G	G	
3300	332	F	F	F	F	F	F	F	F	F	F	F	F	F	F	G	F	F	F	F	F	F	F	F	F	G	G	G	G	G	G	G	G	G	
3900	392	F	F	F	F	F	F	F	F	F	F	F	F	F	F	G	F	F	F	F	F	F	F	F	F	G	G	G	G	G	G	G	G	G	
4700	472	F	F	F	F	F	F	F	F	F	F	F	F	F	F	G	F	F	F	F	F	F	F	F	F	G	G	G	G	G	G	G	G	G	
5600	562	F	F	F	F	F	F	F	F	F	F	F	F	F	F	G	F	F	F	F	F	F	F	F	F	G	G	G	G	G	G	G	G	G	
6800	682	F	F	F	G	G	G	G	F	F	F	F	F	F	G	G	F	F	F	F	F	F	G	G	G	G	G	G	G	G	G	G	G	G	
8200	822	F	F	F	G	G	G	G	F	F	F	G	G	G	G	F	F	F	F	F	G	G	G	G	G	G	G	G	G	G	G	G	G		
Cap (µF)	0.010	103	F	F	F	G	G	G	G	F	F	F	G	G	G	G	F	F	F	F	F	G	G	G	G	G	G	G	G	G	G	G	G	G	
0.015	153	F	F	F	G	G	G	G	F	F	F	G	G	G	G	F	F	F	G	G	G	G	G	G	G	G	G	G	G	G	G	G	G		
0.018	183	F	F	F	G	G	G	G	F	F	F	G	G	G	G	F	F	F	G	G	G	G	G	G	G	G	G	G	G	G	G	G	G		
0.022	223	F	F	F	G	G			F	F	F	G	G			F	F	F	G	G	G				G	G	G	G	G	G	G				
0.027	273	F	F	F	G				F	F	F	G	G			F	F	F	G	G					G	G	G	G	G						
0.033	333	F	F	F	G				F	F	F	G				F	F	F	G						G	G	G	G							
0.039	393	F	F	F	G				F	F	F	G				F	F	F	G						G	G	G	G							
0.047	473	F	F	F	P				F	F	F	G				F	F	F	G						G	G	G	G							
0.056	563	F	F	F	G				F	F	F	G				F	F	F	G						G	G	G	G							
0.068	683	F	F	G					F	F	G					F	F	F	G						G	G	G	G							
0.082	823	F	F	G					F	F	G					F	F	G							G	G									
0.100	104	F	F	G					F	F	G					F	F	G							G	G									
0.150	154	F	F						F	F	G					F	F	G							G	G									
0.220	224	F	F						F	F	G					F	F								G	G									
0.270	274	F	F						F	F						F	F								G	G									
0.330	334	F	F						F	F						F	F								G	G									
0.390	394	F	F						F	F						F	F								G	G									
0.470	474	F	F						F	F						F	F								G	G									
0.560	564	G	G						G	G						F	F								G	G									
0.680	684								G	G						G	G																		
0.820	824															G	G																		
1.000	105																																		
Voltage (V)	600	630	1000	1500	2000	2500	3000	4000	600	630	1000	1500	2000	2500	3000	4000	5000	600	630	1000	1500	2000	2500	3000	4000	5000	600	630	1000	1500	2000	2500	3000	4000	5000
Case Size	1825								2220								2225								3640										

Letter	A	C	E	F	G	X	7
Max. Thickness	0.813 (0.032)	1.448 (0.057)	1.8034 (0.071)	2.2098 (0.087)	2.794 (0.110)	0.940 (0.037)	3.30 (0.130)

NOTE: Contact factory for non-specified capacitance values

# High Voltage MLC Chips

## Tin/Lead Termination "B" - 600V to 5000V Applications

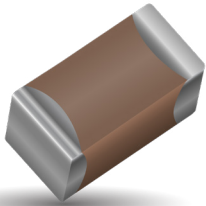

AVX Corporation will support those customers for commercial and military Multilayer Ceramic Capacitors with a termination consisting of 5% minimum lead. This termination is indicated by the use of a "B" in the 12th position of the AVX Catalog Part Number. This fulfills AVX's commitment to providing a full range of products to our customers. AVX has provided in the following pages, a full range of values that we are offering in this "B" termination.

Larger physical sizes than normally encountered chips are used to make high voltage MLC chip product. Special precautions must be taken in applying these chips in surface mount assemblies. The temperature gradient during heating or cooling cycles should not exceed 4°C per second.

The preheat temperature must be within 50°C of the peak temperature reached by the ceramic bodies through the soldering process. Chip sizes 1210 and larger should be reflow soldered only. Capacitors may require protective surface coating to prevent external arcing.

For 1825, 2225 and 3640 sizes, AVX offers leaded version in either thru-hole or SMT configurations (for details see section on high voltage leaded MLC chips).

### NEW 630V RANGE

## HOW TO ORDER

LD08	A	A	271	K	A	B	1	A
AVX Style	Voltage	Temperature Coefficient	Capacitance Code	Capacitance Tolerance	Test Level	Termination*	Packaging	Special Code
LD05 - 0805	600V/630V = C	COG = A	(2 significant digits + no. of zeros)	COG: J = ±5%	A = Standard	B = 5% Min Pb	2 = 7" Reel**	A = Standard
LD06 - 1206	1000V = A	X7R = C	Examples:	K = ±10%	4 = Automotive*	X = FLEXITERM®	4 = 13" Reel	
LD10 - 1210	1500V = S		10 pF = 100	M = ±20%		5% min. Pb		
LD08 - 1808	2000V = G		100 pF = 101	X7R: K = ±10%				
LD12 - 1812	2500V = W		1,000 pF = 102	M = ±20%				
LD13 - 1825	3000V = H		22,000 pF = 223	Z = +80%, -20%				
LD20 - 2220	4000V = J		220,000 pF = 224					
LD14 - 2225	5000V = K		1 μF = 105					
LD40 - 3640								

Notes: Capacitors with X7R dielectrics are not intended for applications across AC supply mains or AC line filtering with polarity reversal. Contact plant for recommendations. Contact factory for availability of Termination and Tolerance options for Specific Part Numbers.

\* FLEXITERM is not available in the LD40 Style

\*\* The LD40 Style is not available on 7" Reels.

\*\*\* AVX offers nonstandard chip sizes. Contact factory for details..

\* Not all values are supported in Automotive grade. Please contact factory for availability.

**NOT RoHS Compliant**

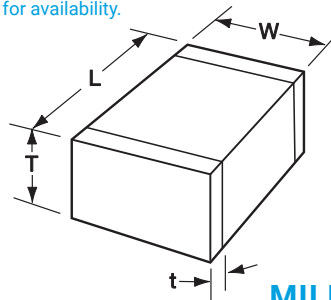

## DIMENSIONS

## MILLIMETERS (INCHES)

SIZE	LD05 (0805)	LD06 (1206)	LD10* (1210)	LD08* (1808)	LD12* (1812)	LD13* (1825)	LD20* (2220)	LD14* (2225)	LD40* (3640)
(L) Length	2.10 ± 0.20 (0.083 ± 0.008)	3.30 ± 0.30 (0.130 ± 0.012)	3.30 ± 0.40 (0.130 ± 0.016)	4.60 ± 0.50 (0.181 ± 0.020)	4.60 ± 0.50 (0.181 ± 0.020)	4.60 ± 0.50 (0.181 ± 0.020)	5.70 ± 0.50 (0.224 ± 0.020)	5.70 ± 0.50 (0.224 ± 0.020)	9.14 ± 0.25 (0.360 ± 0.010)
(W) Width	1.25 ± 0.20 (0.049 ± 0.008)	1.60 ± 0.20 (0.063 ± 0.008)	2.50 ± 0.30 (0.098 ± 0.012)	2.00 ± 0.20 (0.079 ± 0.008)	3.20 ± 0.30 (0.126 ± 0.012)	6.30 ± 0.40 (0.248 ± 0.016)	5.00 ± 0.40 (0.197 ± 0.016)	6.30 ± 0.40 (0.248 ± 0.016)	10.2 ± 0.25 (0.400 ± 0.010)
(T) Thickness Max.	1.35 (0.053)	1.80 (0.071)	2.80 (0.110)	2.20 (0.087)	2.80 (0.110)	3.40 (0.134)	3.40 (0.134)	3.40 (0.134)	2.54 (0.100)
(t) terminal min. max.	0.50 ± 0.20 (0.020 ± 0.008)	0.60 ± 0.20 (0.024 ± 0.008)	0.75 ± 0.35 (0.030 ± 0.014)	0.75 ± 0.35 (0.030 ± 0.014)	0.75 ± 0.35 (0.030 ± 0.014)	0.75 ± 0.35 (0.030 ± 0.014)	0.85 ± 0.35 (0.033 ± 0.014)	0.85 ± 0.35 (0.033 ± 0.014)	0.76 (0.030) 1.52 (0.060)

\*Reflow Soldering Only

Performance of ceramic capacitors can be simulated by using the online SpiMLCC software program - <http://spicat.avx.com/mlcc>  
Custom values, ratings and configurations are also available.

# High Voltage MLC Chips

## Tin/Lead Termination "B" - 600V to 5000V Applications



### NP0 (C0G) Dielectric

#### Performance Characteristics

Capacitance Range	10 pF to 0.047 $\mu$ F (25°C, 1.0 $\pm$ 0.2 Vrms at 1kHz, for $\leq$ 1000 pF use 1 MHz)
Capacitance Tolerances	$\pm$ 5%, $\pm$ 10%, $\pm$ 20%
Dissipation Factor	0.1% max. (+25°C, 1.0 $\pm$ 0.2 Vrms, 1kHz, for $\leq$ 1000 pF use 1 MHz)
Operating Temperature Range	-55°C to +125°C
Temperature Characteristic	0 $\pm$ 30 ppm/°C (0 VDC)
Voltage Ratings	600, 630, 1000, 1500, 2000, 2500, 3000, 4000 & 5000 VDC (+125°C)
Insulation Resistance (+25°C, at 500 VDC)	100K M $\Omega$ min. or 1000 M $\Omega$ - $\mu$ F min., whichever is less
Insulation Resistance (+125°C, at 500 VDC)	10K M $\Omega$ min. or 100 M $\Omega$ - $\mu$ F min., whichever is less
Dielectric Strength	Minimum 120% rated voltage for 5 seconds at 50 mA max. current

### HIGH VOLTAGE C0G CAPACITANCE VALUES

VOLTAGE	LD05 (0805)	LD06 (1206)	LD10 (1210)	LD08 (1808)	LD12 (1812)	LD13 (1825)	LD20 (2220)	LD14 (2225)	LD40 (3640)	
600/630	min.	10 pF	10 pF	100 pF	100 pF	100 pF	1000 pF	1000 pF	1000 pF	1000 pF
	max.	330 pF	1200 pF	2700 pF	3300 pF	5600 pF	0.012 $\mu$ F	0.012 pF	0.018 $\mu$ F	0.047 $\mu$ F
1000	min.	10 pF	10 pF	10 pF	100 pF	100 pF	100 pF	1000 pF	1000 pF	1000 pF
	max.	180 pF	560 pF	1500 pF	2200 pF	3300 pF	8200 pF	0.010 pF	0.010 $\mu$ F	0.022 $\mu$ F
1500	min.	-	10 pF	10 pF	10 pF	10 pF	100 pF	100 pF	100 pF	100 pF
	max.	-	270 pF	680 pF	820 pF	1800 pF	4700 pF	4700 pF	5600 pF	0.010 $\mu$ F
2000	min.	-	10 pF	10 pF	10 pF	10 pF	100 pF	100 pF	100 pF	100 pF
	max.	-	120 pF	270 pF	330 pF	1000 pF	1800 pF	2200 pF	2700 pF	6800 pF
2500	min.	-	-	-	10 pF	10 pF	10 pF	100 pF	100 pF	100 pF
	max.	-	-	-	180 pF	470 pF	1200 pF	1500 pF	1800 pF	3900 pF
3000	min.	-	-	-	10 pF	10 pF	10 pF	10 pF	10 pF	100 pF
	max.	-	-	-	120 pF	330 pF	820 pF	1000 pF	1200 pF	2700 pF
4000	min.	-	-	-	10 pF	10 pF	10 pF	10 pF	10 pF	100 pF
	max.	-	-	-	47 pF	150 pF	330 pF	470 pF	560 pF	1200 pF
5000	min.	-	-	-	-	-	-	10 pF	10 pF	10 pF
	max.	-	-	-	-	-	-	220 pF	270 pF	820 pF

### X7R Dielectric

#### Performance Characteristics

Capacitance Range	10 pF to 0.56 $\mu$ F (25°C, 1.0 $\pm$ 0.2 Vrms at 1kHz)
Capacitance Tolerances	$\pm$ 10%; $\pm$ 20%; +80%, -20%
Dissipation Factor	2.5% max. (+25°C, 1.0 $\pm$ 0.2 Vrms, 1kHz)
Operating Temperature Range	-55°C to +125°C
Temperature Characteristic	$\pm$ 15% (0 VDC)
Voltage Ratings	600, 630, 1000, 1500, 2000, 2500, 3000, 4000 & 5000 VDC (+125°C)
Insulation Resistance (+25°C, at 500 VDC)	100K M $\Omega$ min. or 1000 M $\Omega$ - $\mu$ F min., whichever is less
Insulation Resistance (+125°C, at 500 VDC)	10K M $\Omega$ min. or 100 M $\Omega$ - $\mu$ F min., whichever is less
Dielectric Strength	Minimum 120% rated voltage for 5 seconds at 50 mA max. current

### HIGH VOLTAGE X7R MAXIMUM CAPACITANCE VALUES

VOLTAGE	0805	1206	1210	1808	1812	1825	2220	2225	3640	
600/630	min.	100 pF	1000 pF	1000 pF	1000 pF	1000 pF	0.010 $\mu$ F	0.010 $\mu$ F	0.010 $\mu$ F	0.010 $\mu$ F
	max.	6800 pF	0.022 $\mu$ F	0.056 $\mu$ F	0.068 $\mu$ F	0.120 $\mu$ F	0.390 $\mu$ F	0.270 $\mu$ F	0.330 $\mu$ F	0.560 $\mu$ F
1000	min.	100 pF	100 pF	1000 pF	1000 pF	1000 pF	1000 pF	1000 pF	1000 pF	0.010 $\mu$ F
	max.	1500 pF	6800 pF	0.015 $\mu$ F	0.018 $\mu$ F	0.039 $\mu$ F	0.100 $\mu$ F	0.120 $\mu$ F	0.150 $\mu$ F	0.220 $\mu$ F
1500	min.	-	100 pF	100 pF	100 pF	100 pF	1000 pF	1000 pF	1000 pF	1000 pF
	max.	-	2700 pF	5600 pF	6800 pF	0.015 $\mu$ F	0.056 $\mu$ F	0.056 $\mu$ F	0.068 $\mu$ F	0.100 $\mu$ F
2000	min.	-	10 pF	100 pF	100 pF	100 pF	100 pF	1000 pF	1000 pF	1000 pF
	max.	-	1500 pF	3300 pF	3300 pF	8200 pF	0.022 $\mu$ F	0.027 $\mu$ F	0.033 $\mu$ F	0.027 $\mu$ F
2500	min.	-	-	-	10 pF	10 pF	100 pF	100 pF	100 pF	1000 pF
	max.	-	-	-	2200 pF	5600 pF	0.015 $\mu$ F	0.018 $\mu$ F	0.022 $\mu$ F	0.022 $\mu$ F
3000	min.	-	-	-	10 pF	10 pF	100 pF	100 pF	100 pF	1000 pF
	max.	-	-	-	1800 pF	3900 pF	0.010 $\mu$ F	0.012 $\mu$ F	0.015 $\mu$ F	0.018 $\mu$ F
4000	min.	-	-	-	-	-	-	-	-	100 pF
	max.	-	-	-	-	-	-	-	-	6800 pF
5000	min.	-	-	-	-	-	-	-	-	100 pF
	max.	-	-	-	-	-	-	-	-	3300 pF

# High Voltage MLC Chips

## FLEXITERM® - 600V to 5000V Applications

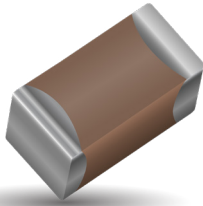

High value, low leakage and small size are difficult parameters to obtain in capacitors for high voltage systems. AVX special high voltage MLC chips capacitors meet these performance characteristics and are designed for applications such as snubbers in high frequency power converters, resonators in SMPS, and high voltage coupling/DC blocking. These high voltage chip designs exhibit low ESRs at high frequencies.

To make high voltage chips, larger physical sizes than are normally encountered are necessary. These larger sizes require that special precautions be taken in applying these chips in surface mount assemblies. In response to this, and to follow from the success of the FLEXITERM® range of low voltage parts, AVX is delighted to offer a FLEXITERM® high voltage range of capacitors, FLEXITERM®.

The FLEXITERM® layer is designed to enhance the mechanical flexure and temperature cycling performance of a standard ceramic capacitor, giving customers a solution where board flexure or temperature cycle damage are concerns.

### HOW TO ORDER

1808	A	C	272	K	A	Z	1	A
<b>AVX Style</b>	<b>Voltage</b>	<b>Temperature Coefficient</b>	<b>Capacitance Code</b> (2 significant digits + no. of zeros)	<b>Capacitance Tolerance</b>	<b>Test Level</b>	<b>Termination*</b>	<b>Packaging</b>	<b>Special Code</b>
0805 1206 1210 1808 1812 1825 2220 2225	600V/630V = C 1000V = A 1500V = S 2000V = G 2500V = W 3000V = H 4000V = J 5000V = K	COG = A X7R = C	Examples: 10 pF = 100 100 pF = 101 1,000 pF = 102 22,000 pF = 223 220,000 pF = 224 1 μF = 105	COG: J = ±5% K = ±10% M = ±20% X7R: K = ±10% M = ±20% Z = +80%, -20%		Z = FLEXITERM® 100% Tin (RoHS Compliant)	2 = 7" Reel 4 = 13" Reel	A = Standard
***								

Notes: Capacitors with X7R dielectrics are not intended for applications across AC supply mains or AC line filtering with polarity reversal. Contact plant for recommendations. Contact factory for availability of Termination and Tolerance options for Specific Part Numbers.

\*\*\* AVX offers nonstandard chip sizes. Contact factory for details.



### DIMENSIONS

### MILLIMETERS (INCHES)

SIZE	0805	1206	1210*	1808*	1812*	1825*	2220*	2225*
(L) Length	2.10 ± 0.20 (0.083 ± 0.008)	3.30 ± 0.30 (0.130 ± 0.012)	3.30 ± 0.40 (0.130 ± 0.016)	4.60 ± 0.50 (0.181 ± 0.020)	4.60 ± 0.50 (0.181 ± 0.020)	4.60 ± 0.50 (0.181 ± 0.020)	5.70 ± 0.50 (0.224 ± 0.020)	5.70 ± 0.50 (0.224 ± 0.020)
(W) Width	1.25 ± 0.20 (0.049 ± 0.008)	1.60 <sup>+0.30</sup> <sub>-0.10</sub> (0.063 <sup>+0.012</sup> <sub>-0.004</sub> )	2.50 ± 0.30 (0.098 ± 0.012)	2.00 ± 0.20 (0.079 ± 0.008)	3.20 ± 0.30 (0.126 ± 0.012)	6.30 ± 0.40 (0.248 ± 0.016)	5.00 ± 0.40 (0.197 ± 0.016)	6.30 ± 0.40 (0.248 ± 0.016)
(T) Thickness Max.	1.35 (0.053)	1.80 (0.071)	2.80 (0.110)	2.20 (0.087)	2.80 (0.110)	3.40 (0.134)	3.40 (0.134)	3.40 (0.134)
(t) terminal min. max.	0.50 ± 0.20 (0.020 ± 0.008)	0.60 ± 0.20 (0.024 ± 0.008)	0.75 ± 0.35 (0.030 ± 0.014)	0.75 ± 0.35 (0.030 ± 0.014)	0.75 ± 0.35 (0.030 ± 0.014)	0.75 ± 0.35 (0.030 ± 0.014)	0.85 ± 0.35 (0.033 ± 0.014)	0.85 ± 0.35 (0.033 ± 0.014)

\*Reflow Soldering Only



Performance of SMPS capacitors can be simulated by downloading SpiCalci software program - <http://www.avx.com/SpiApps/default.asp#spicalci>

Custom values, ratings and configurations are also available.





# High Voltage MLC Chips

## FLEXITERM® - 600V to 5000V Applications



### NP0 (C0G) Dielectric

#### Performance Characteristics

<b>Capacitance Range</b>	10 pF to 0.82 µF (25°C, 1.0 ±0.2 Vrms at 1kHz)
<b>Capacitance Tolerances</b>	±10%; ±20%; +80%, -20%
<b>Dissipation Factor</b>	2.5% max. (+25°C, 1.0 ±0.2 Vrms, 1kHz)
<b>Operating Temperature Range</b>	-55°C to +125°C
<b>Temperature Characteristic</b>	±15% (0 VDC)
<b>Voltage Ratings</b>	600, 630, 1000, 1500, 2000, 2500, 3000, 4000 & 5000 VDC (+125°C)
<b>Insulation Resistance (+25°C, at 500 VDC)</b>	100K MΩ min. or 1000 MΩ - µF min., whichever is less
<b>Insulation Resistance (+125°C, at 500 VDC)</b>	10K MΩ min. or 100 MΩ - µF min., whichever is less
<b>Dielectric Strength</b>	Minimum 120% rated voltage for 5 seconds at 50 mA max. current

### NP0 (C0G) CAPACITANCE RANGE PREFERRED SIZES ARE SHADED

Case Size	0805			1206					1210					1808							1812								
	Reflow/Wave			Reflow/Wave					Reflow Only					Reflow Only							Reflow Only								
(L) Length	2.10 0.20 (0.083 ± 0.008)			3.30 ± 0.30 (0.130 ± 0.012)					3.30 0.40 (0.130 0.016)					4.60 ± 0.50 (0.181 ± 0.020)							4.60 ± 0.50 (0.181 ± 0.020)								
W) Width	1.25 0.20 (0.049 ± 0.008)			1.60 +0.30/-0.10 (0.063 +0.012/-0.004)					2.50 0.30 (0.098 0.012)					2.00 0.20 (0.079 ± 0.008)							3.20 ± 0.30 (0.126 ± 0.012)								
(T) Thickness	1.35 (0.053)			1.80 (0.071)					2.80 (0.110)					2.20 (0.087)							2.80 (0.110)								
(t) Terminal	0.50 ± 0.20 (0.020 ± 0.008)			0.60 ± 0.20 (0.024 ± 0.008)					0.75 0.35 (0.030 ± 0.014)					0.75 ± 0.35 (0.030 ± 0.014)							0.75 ± 0.35 (0.030 ± 0.014)								
Voltage (V)	600	630	1000	600	630	1000	1500	2000	600	630	1000	1500	2000	600	630	1000	1500	2000	2500	3000	4000	600	630	1000	1500	2000	2500	3000	4000
Cap (pF) 100 101	X	X	C	C	C	E	E	E	E	E	E	E	E																
120 121	X	X	C	C	C	E	E	E	E	E	E	E	E																
150 151	X	X	C	C	C	E	E	E	E	E	E	E	E																
180 181	X	X	C	C	C	E	E	E	E	E	E	E	E																
220 221	X	X	C	C	C	E	E	E	E	E	E	E	E																
270 271	X	X	C	C	C	E	E	E	E	E	E	E	E									E	E	E	E	E			
330 331	X	X	C	C	C	E	E	E	E	E	E	E	E	E	E	E	E	E	E	E	F		E	E	E	E	E		
390 391	X	X	C	C	C	E	E	E	E	E	E	E	E	E	E	E	E	E	E	F		E	E	E	E	E			
470 471	X	X	C	C	C	E	E	E	E	E	E	E	E	E	E	E	E	E	F			E	E	E	E	E	E	E	E
560 561	X	X	C	C	C	E	E	E	E	E	E	E	E	E	E	E	E	F	F			E	E	E	E	E	E	E	E
680 681	X	X	C	C	C	E	E	E	E	E	E	E	E	E	E	E	F	F				E	E	E	E	E	F	F	
750 751	X	X	C	C	C	E	E	E	E	E	E	E	E	E	E	E	F	F				E	E	E	E	E	F	F	
820 821	X	X	C	C	C	E	E	E	E	E	E	E	E	E	E	E	F	F				E	E	E	E	E	F	F	
1000 102	X	X	C	C	C	E	E	E	E	E	E	E	E	E	E	E	F	F				E	E	E	E	E	F	F	
1200 122	X	X	C	C	C	E	E	E	E	E	E	E	E	E	E	E	F	F				E	E	E	E	E	F	F	
1500 152	X	X	C	C	C	E	E	E	E	E	E	E	E	E	E	E	F	F				E	E	E	E	E	G	G	
1800 182	X	X		C	C	E	E	E	E	E	E	E	E	E	E	E	F	F				E	E	E	E	E	G	G	
2200 222	X	X		C	C	E	E	E	E	E	E	E	E	E	E	F	F					E	E	E	E	E	G	G	
2700 272	X	X		C	C	E	E							E	E	E	F	F				E	E	E	E	E	G	G	
3300 332	X	X		C	C	E								E	E	E	F	F				E	E	E	F	F	G	G	
3900 392	X	X		C	C	E								E	E	E	F					E	E	E	F	F	G	G	
4700 472	X	X		C	C	E								E	E	E	F					E	E	E	F	F	G	G	
5600 562	X	X		C	C	E								E	E	E	F					E	E	E	G	G			
6800 682	X	X		C	C	E								E	E	E	F					E	E	E	G	G			
8200 822	X	X		C	C	E								E	E	E						E	E	E	G	G			
Cap (µF) 0.010 103	C	C		C	C	E								E	E	E						E	E	F	G	G			
0.015 153	C	C		E	E	E								E	E	E						E	E	F	G				
0.018 183	C	C		E	E	E								E	E	E						E	E	G					
0.022 223	C	C		E	E									E	E	E						E	E	G					
0.027 273				E	E									E	E							E	E	G					
0.033 333				E	E									E	E							E	E	G					
0.039 393														E	E							E	E	G					
0.047 473														E	E							E	E	G					
0.056 563														F	F							F	F						
0.068 683														F	F							F	F						
0.082 823														F	F							F	F						
0.100 104														F	F							F	F						
0.150 154																													
0.220 224																													
0.270 274																													
0.330 334																													
0.390 394																													
0.470 474																													
0.560 564																													
0.680 684																													
0.820 824																													
1.000 105																													
Voltage (V)	600	630	1000	600	630	1000	1500	2000	600	630	1000	1500	2000	600	630	1000	1500	2000	2500	3000	4000	600	630	1000	1500	2000	2500	3000	4000
Case Size	0805			1206					1210					1808							1812								

# High Voltage MLC Chips

## FLEXITERM® - 600V to 5000V Applications



### X7R CAPACITANCE RANGE

#### PREFERRED SIZES ARE SHADED

Case Size	1825								2220								2225									
Soldering	Reflow Only								Reflow Only								Reflow Only									
(L) Length	4.60 0.50 (0.181 0.020)								5.70 0.50 (0.224 0.020)								5.72 ± 0.25 (0.225 ± 0.010)									
(W) Width	6.30 0.40 (0.248 ± 0.016)								5.00 0.40 (0.197 0.016)								6.35 ± 0.25 (0.250 ± 0.010)									
(T) Thickness	3.40 (0.134)								3.40 (0.134)								2.54 (0.100)									
(t) Terminal	0.75 0.35 (0.030 ± 0.014)								0.85 0.35 (0.033 ± 0.014)								0.85 ± 0.35									
Voltage (V)	600	630	1000	1500	2000	2500	3000	4000	600	630	1000	1500	2000	2500	3000	4000	5000	600	630	1000	1500	2000	2500	3000	4000	5000
Cap (pF) 100 101																										
120 121																										
150 151																										
180 181																										
220 221																										
270 271																										
330 331																										
390 391																										
470 471																										
560 561																										
680 681																										
750 751																										
820 821																										
1000 102	F	F	F	F	F	F	F	F	F	F	F	F	F	F	F	G		F	F	F	F	F	F	F	F	F
1200 122	F	F	F	F	F	F	F	F	F	F	F	F	F	F	F	G		F	F	F	F	F	F	F	F	F
1500 152	F	F	F	F	F	F	F	F	F	F	F	F	F	F	F	G		F	F	F	F	F	F	F	F	F
1800 182	F	F	F	F	F	F	F	F	F	F	F	F	F	F	F	G		F	F	F	F	F	F	F	F	F
2200 222	F	F	F	F	F	F	F	F	F	F	F	F	F	F	F	G		F	F	F	F	F	F	F	F	F
2700 272	F	F	F	F	F	F	F	F	F	F	F	F	F	F	F	G		F	F	F	F	F	F	F	F	F
3300 332	F	F	F	F	F	F	F	F	F	F	F	F	F	F	F	G		F	F	F	F	F	F	F	F	F
3900 392	F	F	F	F	F	F	F	F	F	F	F	F	F	F	F	G		F	F	F	F	F	F	F	F	F
4700 472	F	F	F	F	F	F	F	F	F	F	F	F	F	F	F	G		F	F	F	F	F	F	F	F	F
5600 562	F	F	F	F	F	F	F	F	F	F	F	F	F	F	F	G		F	F	F	F	F	F	F	F	F
6800 682	F	F	F	G	G	G	G		F	F	F	F	F	F	G	G		F	F	F	F	F	F	G	G	G
8200 822	F	F	F	G	G	G	G		F	F	F	G	G	G	G			F	F	F	F	F	G	G	G	G
Cap (µF) 0.010 103	F	F	F	G	G	G	G		F	F	F	G	G	G	G			F	F	F	F	F	G	G	G	G
0.015 153	F	F	F	G	G	G			F	F	F	G	G	G				F	F	F	G	G	G	G	G	
0.018 183	F	F	F	G	G				F	F	F	G	G	G				F	F	F	G	G	G	G		
0.022 223	F	F	F	G	G				F	F	F	G	G					F	F	F	G	G	G	G		
0.027 273	F	F	F	G					F	F	F	G	G					F	F	F	G	G				
0.033 333	F	F	F	G					F	F	F	G						F	F	F	G					
0.039 393	F	F	F	G					F	F	F	G						F	F	F	G					
0.047 473	F	F	F	P					F	F	F	G						F	F	F	G					
0.056 563	F	F	F	G					F	F	F	G						F	F	F	G					
0.068 683	F	F	G						F	F	G							F	F	F	G					
0.082 823	F	F	G						F	F	G							F	F	G						
0.100 104	F	F	G						F	F	G							F	F	G						
0.150 154	F	F							F	F	G							F	F	G						
0.220 224	F	F							F	F	G							F	F							
0.270 274	F	F							F	F								F	F							
0.330 334	F	F							F	F								F	F							
0.390 394	F	F							F	F								F	F							
0.470 474	F	F							F	F								F	F							
0.560 564	G	G							G	G								F	F							
0.680 684									G	G								G	G							
0.820 824																		G	G							
1.000 105																										
Voltage (V)	600	630	1000	1500	2000	2500	3000	4000	600	630	1000	1500	2000	2500	3000	4000	5000	600	630	1000	1500	2000	2500	3000	4000	5000
Case Size	1825								2220								2225									

Letter	A	C	E	F	G	P	X
Max. Thickness	0.813 (0.032)	1.448 (0.057)	1.8034 (0.071)	2.2098 (0.087)	2.794 (0.110)	3.048 (0.120)	0.940 (0.037)

NOTE: Contact factory for non-specified capacitance values

# High Voltage MLC Chip Capacitors

## For 600V to 3000V Automotive Applications - AEC-Q200

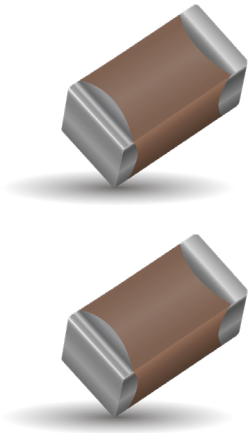

Modern automotive electronics could require components capable to work with high voltage (e.g. xenon lamp circuits or power converters in hybrid cards). AVX offers high voltage ceramic capacitors qualified according to AEC-Q200 standard.

High value, low leakage and small size are difficult parameters to obtain in capacitors for high voltage systems. AVX special high voltage MLC chip capacitors meet these performance characteristics and are designed for applications such as snubbers in high frequency power converters, resonators in SMPS, and high voltage coupling/dc blocking. These high voltage chip designs exhibit low ESRs at high frequencies.

Due to high voltage nature, larger physical dimensions are necessary. These larger sizes require special precautions to be taken in applying of MLC chips. The temperature gradient during heating or cooling cycles should not exceed 4°C per second. The preheat temperature must be within 50°C of the peak temperature reached by the ceramic bodies through the soldering process. Chip sizes 1210 and larger should be reflow soldered only. Capacitors may require protective surface coating to prevent external arcing.

To improve mechanical and thermal resistance, AVX recommend to use flexible terminations system - FLEXITERM®.

### HOW TO ORDER

1210	C	C	223	K	4	T	1	A
<b>Size</b> 1206 1210 1808 1812 2220	<b>Voltage</b> C = 630V A = 1000V S = 1500V G = 2000V W = 2500V H = 3000V	<b>Dielectric</b> X7R = C	<b>Capacitance Code</b> 2 Sig. Digits + Number of Zeros e.g. 103 = 10nF (223 = 22nF)	<b>Capacitance Tolerance</b> K = ±10% M = ±20%	<b>Failure Rate</b> 4=Automotive	<b>Terminations</b> T = Plated Ni and Sn Z = FLEXITERM®	<b>Packaging</b> 1 or 2 = 7" Reel 3 or 4 = 13" Reel	<b>Special Code</b> A = Std. Product

\*AVX offers nonstandard case size. Contact factory for details.

Notes: Capacitors with X7R dielectrics are not intended for applications across AC supply mains or AC line filtering with polarity reversal. Please contact AVX for recommendations

### CHIP DIMENSIONS DESCRIPTION

(See capacitance range chart on page 128)

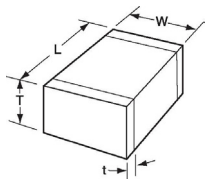

L = Length  
W = Width  
T = Thickness  
t = Terminal

### X7R DIELECTRIC PERFORMANCE CHARACTERISTICS

Parameter/Test	Specification Limits	Measuring Conditions
<b>Operating Temperature Range</b>	-55°C to +125°C	Temperature Cycle Chamber
<b>Capacitance</b> <b>Dissipation Factor</b> <b>Capacitance Tolerance</b>	within specified tolerance 2.5% max. ±5% (J), ±10% (K), ±20% (M)	Freq.: 1kHz ±10% Voltage: 1.0Vrms ±0.2Vrms T = +25°C, V = 0Vdc
<b>Temperature Characteristics</b>	X7R = ±15%	Vdc = 0V, T = (-55°C to +125°C)
<b>Insulation Resistance</b>	100GΩ min. or 1000MΩ · μF min. (whichever is less) 10GΩ min. or 100MΩ · μF min. (whichever is less)	T = +25°C, V = 500Vdc T = +125°C, V = 500Vdc (t ≥ 120 sec, I ≤ 50mA)
<b>Dielectric Strength</b>	No breakdown or visual defect	120% of rated voltage t ≤ 5 sec, I ≤ 50mA

# High Voltage MLC Chips FLEXITERM®

For 600V to 3000V Automotive Applications - AEC-Q200



## X7R CAPACITANCE RANGE

PREFERRED SIZES ARE SHADED

Case Size	1206					1210				1808					1812					2220								
Soldering	Reflow/Wave					ReflowOnly				ReflowOnly					ReflowOnly					ReflowOnly								
(L) Length	mm	3.20 ± 0.20					3.20 ± 0.20				4.57 ± 0.25					4.50 ± 0.30					5.70 ± 0.40							
(L) Length	(in.)	(0.126 ± 0.008)					(0.126 ± 0.008)				(0.180 ± 0.010)					(0.177 ± 0.012)					(0.224 ± 0.016)							
(W) Width	mm	1.60 ± 0.20					2.50 ± 0.20				2.03 ± 0.25					3.20 ± 0.20					5.00 ± 0.40							
(W) Width	(in.)	(0.063 ± 0.008)					(0.098 ± 0.008)				(0.080 ± 0.010)					(0.126 ± 0.008)					(0.197 ± 0.016)							
(T) Thickness	mm	1.52					1.70				2.03					2.54					3.30							
(T) Thickness	(in.)	(0.060)					(0.067)				(0.080)					(0.100)					(0.130)							
(t) Terminal	mm	0.25 (0.010)					0.25 (0.010)				0.25 (0.010)					0.25 (0.010)					0.25 (0.010)							
(t) Terminal	max	0.75 (0.030)					0.75 (0.030)				1.02 (0.040)					1.02 (0.040)					1.02 (0.040)							
Voltage (V)		630	1000	1500	2000	2500	630	1000	1500	2000	630	1000	1500	2000	2500	3000	630	1000	1500	2000	2500	3000	4000	630	1000	1500	2000	3000
Cap (pF)	100	101																										
	120	121																										
	150	151																										
	180	181																										
	220	221																										
	270	271																										
	330	331																										
	390	391																										
	470	471																										
	560	561																										
	680	681																										
	820	821																										
	1000	102																										
	1200	122																										
	1500	152																										
	1800	182																										
	2200	222																										
	2700	272																										
	3300	332																										
	3900	392																										
	4700	472																										
	5600	562																										
	6800	682																										
	8200	822																										
Cap (µF)	0.01	103																										
	0.012	123																										
	0.015	153																										
	0.018	183																										
	0.022	223																										
	0.027	273																										
	0.033	333																										
	0.039	393																										
	0.047	473																										
	0.056	563																										
	0.068	683																										
	0.082	823																										
	0.100	104																										
	0.120	124																										
	0.150	154																										
Voltage (V)		630	1000	1500	2000	2500	630	1000	1500	2000	630	1000	1500	2000	2500	3000	630	1000	1500	2000	2500	3000	4000	630	1000	1500	2000	3000
Case Size		1206					1210				1808					1812					2220							

NOTE: Contact factory for non-specified capacitance values

# MIL-PRF-55681/Chips

Part Number Example  
CDR01 thru CDR06

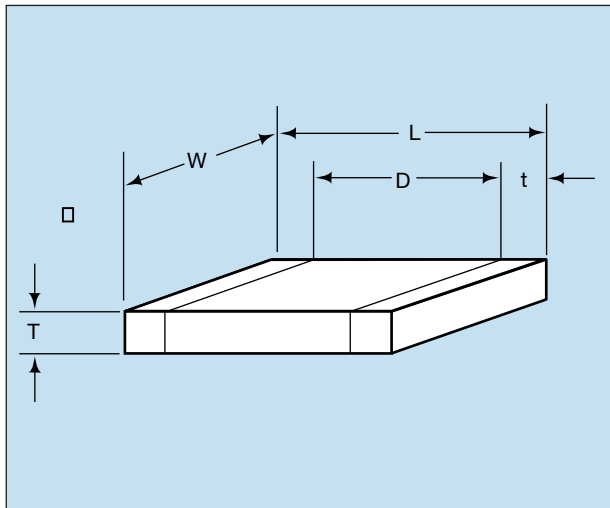

## MILITARY DESIGNATION PER MIL-PRF-55681

### Part Number Example

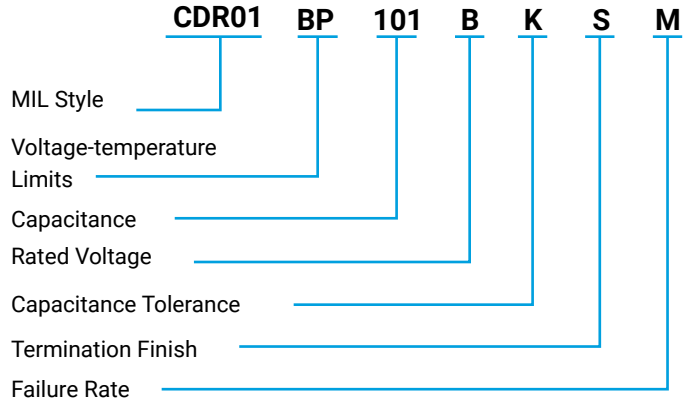

NOTE: Contact factory for availability of Termination and Tolerance Options for Specific Part Numbers.

**MIL Style:** CDR01, CDR02, CDR03, CDR04, CDR05, CDR06

**Voltage Temperature Limits:**

BP =  $0 \pm 30$  ppm/°C without voltage;  $0 \pm 30$  ppm/°C with rated voltage from -55°C to +125°C

BX =  $\pm 15\%$  without voltage;  $+15 - 25\%$  with rated voltage from -55°C to +125°C

**Capacitance:** Two digit figures followed by multiplier (number of zeros to be added) e.g., 101 = 100 pF

**Rated Voltage:** A = 50V, B = 100V

**Capacitance Tolerance:** J  $\pm 5\%$ , K  $\pm 10\%$ , M  $\pm 20\%$

**Termination Finish:**

- M = Palladium silver
- N = Silver-nickel-gold
- S = Solder coated final with a minimum of 4 percent lead
- T = Silver
- U = Base metallization-barrier metal-solder coated (tin/lead alloy, with a minimum of 4 percent lead)
- W = Base metallization-barrier metal-tinned (tin or tin/lead alloy)
- Y = Base metallization-barrier metal-tin (100 percent)
- Z = Base metallization-barrier metal-tinned (tin/lead alloy, with a minimum of 4 percent lead)

\*See MIL-PRF-55681 Specification for more details

**Failure Rate Level:** M = 1.0%, P = .1%, R = .01%, S = .001%

**Packaging:** Bulk is standard packaging. Tape and reel per RS481 is available upon request.

**\*Not RoHS Compliant**

## CROSS REFERENCE: AVX/MIL-PRF-55681/CDR01 THRU CDR06\*

Per MIL-PRF-55681	AVX Style	Length (L)	Width (W)	Thickness (T)		D		Termination Band (t)	
				Min.	Max.	Min.	Max.	Min.	Max.
CDR01	0805	.080 ± .015	.050 ± .015	.022	.055	.030	—	.010	—
CDR02	1805	.180 ± .015	.050 ± .015	.022	.055	—	—	.010	.030
CDR03	1808	.180 ± .015	.080 ± .018	.022	.080	—	—	.010	.030
CDR04	1812	.180 ± .015	.125 ± .015	.022	.080	—	—	.010	.030
CDR05	1825	.180 <sup>+</sup> .020 -.015	.250 <sup>+</sup> .020 -.015	.020	.080	—	—	.010	.030
CDR06	2225	.225 ± .020	.250 ± .020	.020	.080	—	—	.010	.030

\*For CDR11, 12, 13, and 14 see AVX Microwave Chip Capacitor Catalog



### CDR01 thru CDR06 to MIL-PRF-55681

Military Type Designation	Capacitance in pF	Capacitance tolerance	Rated temperature and voltage-temperature limits	WVDC
<b>AVX Style 0805/CDR01</b>				
CDR01BP100B--	10	J,K	BP	100
CDR01BP120B--	12	J	BP	100
CDR01BP150B--	15	J,K	BP	100
CDR01BP180B--	18	J	BP	100
CDR01BP220B--	22	J,K	BP	100
CDR01BP270B--	27	J	BP	100
CDR01BP330B--	33	J,K	BP	100
CDR01BP390B--	39	J	BP	100
CDR01BP470B--	47	J,K	BP	100
CDR01BP560B--	56	J	BP	100
CDR01BP680B--	68	J,K	BP	100
CDR01BP820B--	82	J	BP	100
CDR01BP101B--	100	J,K	BP	100
CDR01B--121B--	120	J,K	BP,BX	100
CDR01B--151B--	150	J,K	BP,BX	100
CDR01B--181B--	180	J,K	BP,BX	100
CDR01BX221B--	220	K,M	BX	100
CDR01BX271B--	270	K	BX	100
CDR01BX331B--	330	K,M	BX	100
CDR01BX391B--	390	K	BX	100
CDR01BX471B--	470	K,M	BX	100
CDR01BX561B--	560	K	BX	100
CDR01BX681B--	680	K,M	BX	100
CDR01BX821B--	820	K	BX	100
CDR01BX102B--	1000	K,M	BX	100
CDR01BX122B--	1200	K	BX	100
CDR01BX152B--	1500	K,M	BX	100
CDR01BX182B--	1800	K	BX	100
CDR01BX222B--	2200	K,M	BX	100
CDR01BX272B--	2700	K	BX	100
CDR01BX332B--	3300	K,M	BX	100
CDR01BX392A--	3900	K	BX	50
CDR01BX472A--	4700	K,M	BX	50
<b>AVX Style 1805/CDR02</b>				
CDR02BP221B--	220	J,K	BP	100
CDR02BP271B--	270	J	BP	100
CDR02BX392B--	3900	K	BX	100
CDR02BX472B--	4700	K,M	BX	100
CDR02BX562B--	5600	K	BX	100
CDR02BX682B--	6800	K,M	BX	100
CDR02BX822B--	8200	K	BX	100
CDR02BX103B--	10,000	K,M	BX	100
CDR02BX123A--	12,000	K	BX	50
CDR02BX153A--	15,000	K,M	BX	50
CDR02BX183A--	18,000	K	BX	50
CDR02BX223A--	22,000	K,M	BX	50

Add appropriate failure rate  
 Add appropriate termination finish  
 Capacitance Tolerance

Military Type Designation/	Capacitance in pF	Capacitance tolerance	Rated temperature and voltage-temperature limits	WVDC
<b>AVX Style 1808/CDR03</b>				
CDR03BP331B--	330	J,K	BP	100
CDR03BP391B--	390	J	BP	100
CDR03BP471B--	470	J,K	BP	100
CDR03BP561B--	560	J	BP	100
CDR03BP681B--	680	J,K	BP	100
CDR03BP821B--	820	J	BP	100
CDR03BP102B--	1000	J,K	BP	100
CDR03BX123B--	12,000	K	BX	100
CDR03BX153B--	15,000	K,M	BX	100
CDR03BX183B--	18,000	K	BX	100
CDR03BX223B--	22,000	K,M	BX	100
CDR03BX273B--	27,000	K	BX	100
CDR03BX333B--	33,000	K,M	BX	100
CDR03BX393A--	39,000	K	BX	50
CDR03BX473A--	47,000	K,M	BX	50
CDR03BX563A--	56,000	K	BX	50
CDR03BX683A--	68,000	K,M	BX	50
<b>AVX Style 1812/CDR04</b>				
CDR04BP122B--	1200	J	BP	100
CDR04BP152B--	1500	J,K	BP	100
CDR04BP182B--	1800	J	BP	100
CDR04BP222B--	2200	J,K	BP	100
CDR04BP272B--	2700	J	BP	100
CDR04BP332B--	3300	J,K	BP	100
CDR04BX393B--	39,000	K	BX	100
CDR04BX473B--	47,000	K,M	BX	100
CDR04BX563B--	56,000	K	BX	100
CDR04BX823A--	82,000	K	BX	50
CDR04BX104A--	100,000	K,M	BX	50
CDR04BX124A--	120,000	K	BX	50
CDR04BX154A--	150,000	K,M	BX	50
CDR04BX184A--	180,000	K	BX	50
<b>AVX Style 1825/CDR05</b>				
CDR05BP392B--	3900	J,K	BP	100
CDR05BP472B--	4700	J,K	BP	100
CDR05BP562B--	5600	J,K	BP	100
CDR05BX683B--	68,000	K,M	BX	100
CDR05BX823B--	82,000	K	BX	100
CDR05BX104B--	100,000	K,M	BX	100
CDR05BX124B--	120,000	K	BX	100
CDR05BX154B--	150,000	K,M	BX	100
CDR05BX224A--	220,000	K,M	BX	50
CDR05BX274A--	270,000	K	BX	50
CDR05BX334A--	330,000	K,M	BX	50
<b>AVX Style 2225/CDR06</b>				
CDR06BP682B--	6800	J,K	BP	100
CDR06BP822B--	8200	J,K	BP	100
CDR06BP103B--	10,000	J,K	BP	100
CDR06BX394A--	390,000	K	BX	50
CDR06BX474A--	470,000	K,M	BX	50

Add appropriate failure rate  
 Add appropriate termination finish  
 Capacitance Tolerance

# MIL-PRF-55681/Chips

Part Number Example  
CDR31 thru CDR35



## MILITARY DESIGNATION PER MIL-PRF-55681



NOTE: Contact factory for availability of Termination and Tolerance Options for Specific Part Numbers.

**MIL Style:** CDR31, CDR32, CDR33, CDR34, CDR35

**Voltage Temperature Limits:**

BP =  $0 \pm 30$  ppm/°C without voltage;  $0 \pm 30$  ppm/°C with rated voltage from -55°C to +125°C

BX =  $\pm 15\%$  without voltage;  $+15 - 25\%$  with rated voltage from -55°C to +125°C

**Capacitance:** Two digit figures followed by multiplier (number of zeros to be added) e.g., 101 = 100 pF

**Rated Voltage:** A = 50V, B = 100V

**Capacitance Tolerance:** B  $\pm .10$  pF, C  $\pm .25$  pF, D  $\pm .5$  pF, F  $\pm 1\%$ , J  $\pm 5\%$ , K  $\pm 10\%$ , M  $\pm 20\%$

**Termination Finish:**

- M = Palladium silver
- N = Silver-nickel-gold
- S = Solder coated final with a minimum of 4 percent lead
- T = Silver
- U = Base metallization-barrier metal-solder coated (tin/lead alloy, with a minimum of 4 percent lead)
- W = Base metallization-barrier metal-tinned (tin or tin/lead alloy)
- Y = Base metallization-barrier metal-tin (100 percent)
- Z = Base metallization-barrier metal-tinned (tin/lead alloy, with a minimum of 4 percent lead)

\*See MIL-PRF-55681 Specification for more details

**Failure Rate Level:** M = 1.0%, P = .1%, R = .01%, S = .001%

**Packaging:** Bulk is standard packaging. Tape and reel per RS481 is available upon request.

**\*Not RoHS Compliant**

## CROSS REFERENCE: AVX/MIL-PRF-55681/CDR31 THRU CDR35

Per MIL-PRF-55681	AVX Style	Length (L) (mm)	Width (W) (mm)	Thickness (T)	D	Termination Band (t)	
				Max. (mm)		Max. (mm)	Min. (mm)
CDR31	0805	2.00	1.25	1.3	.50	.70	.30
CDR32	1206	3.20	1.60	1.3	—	.70	.30
CDR33	1210	3.20	2.50	1.5	—	.70	.30
CDR34	1812	4.50	3.20	1.5	—	.70	.30
CDR35	1825	4.50	6.40	1.5	—	.70	.30



### CDR31 to MIL-PRF-55681/7

Military Type Designation 1/	Capacitance in pF	Capacitance tolerance	Rated temperature and voltage-temperature limits	WVDC
<b>AVX Style 0805/CDR31 (BP)</b>				
CDR31BP1R0B--	1.0	B,C	BP	100
CDR31BP1R1B--	1.1	B,C	BP	100
CDR31BP1R2B--	1.2	B,C	BP	100
CDR31BP1R3B--	1.3	B,C	BP	100
CDR31BP1R5B--	1.5	B,C	BP	100
CDR31BP1R6B--	1.6	B,C	BP	100
CDR31BP1R8B--	1.8	B,C	BP	100
CDR31BP2R0B--	2.0	B,C	BP	100
CDR31BP2R2B--	2.2	B,C	BP	100
CDR31BP2R4B--	2.4	B,C	BP	100
CDR31BP2R7B--	2.7	B,C,D	BP	100
CDR31BP3R0B--	3.0	B,C,D	BP	100
CDR31BP3R3B--	3.3	B,C,D	BP	100
CDR31BP3R6B--	3.6	B,C,D	BP	100
CDR31BP3R9B--	3.9	B,C,D	BP	100
CDR31BP4R3B--	4.3	B,C,D	BP	100
CDR31BP4R7B--	4.7	B,C,D	BP	100
CDR31BP5R1B--	5.1	B,C,D	BP	100
CDR31BP5R6B--	5.6	B,C,D	BP	100
CDR31BP6R2B--	6.2	B,C,D	BP	100
CDR31BP6R8B--	6.8	B,C,D	BP	100
CDR31BP7R5B--	7.5	B,C,D	BP	100
CDR31BP8R2B--	8.2	B,C,D	BP	100
CDR31BP9R1B--	9.1	B,C,D	BP	100
CDR31BP100B--	10	F,J,K	BP	100
CDR31BP110B--	11	F,J,K	BP	100
CDR31BP120B--	12	F,J,K	BP	100
CDR31BP130B--	13	F,J,K	BP	100
CDR31BP150B--	15	F,J,K	BP	100
CDR31BP160B--	16	F,J,K	BP	100
CDR31BP180B--	18	F,J,K	BP	100
CDR31BP200B--	20	F,J,K	BP	100
CDR31BP220B--	22	F,J,K	BP	100
CDR31BP240B--	24	F,J,K	BP	100
CDR31BP270B--	27	F,J,K	BP	100
CDR31BP300B--	30	F,J,K	BP	100
CDR31BP330B--	33	F,J,K	BP	100
CDR31BP360B--	36	F,J,K	BP	100
CDR31BP390B--	39	F,J,K	BP	100
CDR31BP430B--	43	F,J,K	BP	100
CDR31BP470B--	47	F,J,K	BP	100
CDR31BP510B--	51	F,J,K	BP	100
CDR31BP560B--	56	F,J,K	BP	100
CDR31BP620B--	62	F,J,K	BP	100
CDR31BP680B--	68	F,J,K	BP	100
CDR31BP750B--	75	F,J,K	BP	100
CDR31BP820B--	82	F,J,K	BP	100
CDR31BP910B--	91	F,J,K	BP	100

Add appropriate failure rate  
 Add appropriate termination finish  
 Capacitance Tolerance

Military Type Designation 1/	Capacitance in pF	Capacitance tolerance	Rated temperature and voltage-temperature limits	WVDC
<b>AVX Style 0805/CDR31 (BP) cont'd</b>				
CDR31BP101B--	100	F,J,K	BP	100
CDR31BP111B--	110	F,J,K	BP	100
CDR31BP121B--	120	F,J,K	BP	100
CDR31BP131B--	130	F,J,K	BP	100
CDR31BP151B--	150	F,J,K	BP	100
CDR31BP161B--	160	F,J,K	BP	100
CDR31BP181B--	180	F,J,K	BP	100
CDR31BP201B--	200	F,J,K	BP	100
CDR31BP221B--	220	F,J,K	BP	100
CDR31BP241B--	240	F,J,K	BP	100
CDR31BP271B--	270	F,J,K	BP	100
CDR31BP301B--	300	F,J,K	BP	100
CDR31BP331B--	330	F,J,K	BP	100
CDR31BP361B--	360	F,J,K	BP	100
CDR31BP391B--	390	F,J,K	BP	100
CDR31BP431B--	430	F,J,K	BP	100
CDR31BP471B--	470	F,J,K	BP	100
CDR31BP511A--	510	F,J,K	BP	50
CDR31BP561A--	560	F,J,K	BP	50
CDR31BP621A--	620	F,J,K	BP	50
CDR31BP681A--	680	F,J,K	BP	50
<b>AVX Style 0805/CDR31 (BX)</b>				
CDR31BX471B--	470	K,M	BX	100
CDR31BX561B--	560	K,M	BX	100
CDR31BX681B--	680	K,M	BX	100
CDR31BX821B--	820	K,M	BX	100
CDR31BX102B--	1,000	K,M	BX	100
CDR31BX122B--	1,200	K,M	BX	100
CDR31BX152B--	1,500	K,M	BX	100
CDR31BX182B--	1,800	K,M	BX	100
CDR31BX222B--	2,200	K,M	BX	100
CDR31BX272B--	2,700	K,M	BX	100
CDR31BX332B--	3,300	K,M	BX	100
CDR31BX392B--	3,900	K,M	BX	100
CDR31BX472B--	4,700	K,M	BX	100
CDR31BX562A--	5,600	K,M	BX	50
CDR31BX682A--	6,800	K,M	BX	50
CDR31BX822A--	8,200	K,M	BX	50
CDR31BX103A--	10,000	K,M	BX	50
CDR31BX123A--	12,000	K,M	BX	50
CDR31BX153A--	15,000	K,M	BX	50
CDR31BX183A--	18,000	K,M	BX	50

Add appropriate failure rate  
 Add appropriate termination finish  
 Capacitance Tolerance

1/ The complete part number will include additional symbols to indicate capacitance tolerance, termination and failure rate level.

### CDR32 to MIL-PRF-55681/8

Military Type Designation 1/	Capacitance in pF	Capacitance tolerance	Rated temperature and voltage-temperature limits	WVDC
<b>AVX Style 1206/CDR32 (BP)</b>				
CDR32BP1R0B--	1.0	B,C	BP	100
CDR32BP1R1B--	1.1	B,C	BP	100
CDR32BP1R2B--	1.2	B,C	BP	100
CDR32BP1R3B--	1.3	B,C	BP	100
CDR32BP1R5B--	1.5	B,C	BP	100
CDR32BP1R6B--	1.6	B,C	BP	100
CDR32BP1R8B--	1.8	B,C	BP	100
CDR32BP2R0B--	2.0	B,C	BP	100
CDR32BP2R2B--	2.2	B,C	BP	100
CDR32BP2R4B--	2.4	B,C	BP	100
CDR32BP2R7B--	2.7	B,C,D	BP	100
CDR32BP3R0B--	3.0	B,C,D	BP	100
CDR32BP3R3B--	3.3	B,C,D	BP	100
CDR32BP3R6B--	3.6	B,C,D	BP	100
CDR32BP3R9B--	3.9	B,C,D	BP	100
CDR32BP4R3B--	4.3	B,C,D	BP	100
CDR32BP4R7B--	4.7	B,C,D	BP	100
CDR32BP5R1B--	5.1	B,C,D	BP	100
CDR32BP5R6B--	5.6	B,C,D	BP	100
CDR32BP6R2B--	6.2	B,C,D	BP	100
CDR32BP6R8B--	6.8	B,C,D	BP	100
CDR32BP7R5B--	7.5	B,C,D	BP	100
CDR32BP8R2B--	8.2	B,C,D	BP	100
CDR32BP9R1B--	9.1	B,C,D	BP	100
CDR32BP100B--	10	FJ,K	BP	100
CDR32BP110B--	11	F,J,K	BP	100
CDR32BP120B--	12	FJ,K	BP	100
CDR32BP130B--	13	FJ,K	BP	100
CDR32BP150B--	15	FJ,K	BP	100
CDR32BP160B--	16	FJ,K	BP	100
CDR32BP180B--	18	FJ,K	BP	100
CDR32BP200B--	20	F,J,K	BP	100
CDR32BP220B--	22	FJ,K	BP	100
CDR32BP240B--	24	F,J,K	BP	100
CDR32BP270B--	27	FJ,K	BP	100
CDR32BP300B--	30	FJ,K	BP	100
CDR32BP330B--	33	F,J,K	BP	100
CDR32BP360B--	36	FJ,K	BP	100
CDR32BP390B--	39	F,J,K	BP	100
CDR32BP430B--	43	FJ,K	BP	100
CDR32BP470B--	47	FJ,K	BP	100
CDR32BP510B--	51	F,J,K	BP	100
CDR32BP560B--	56	FJ,K	BP	100
CDR32BP620B--	62	F,J,K	BP	100
CDR32BP680B--	68	FJ,K	BP	100
CDR32BP750B--	75	FJ,K	BP	100
CDR32BP820B--	82	F,J,K	BP	100
CDR32BP910B--	91	FJ,K	BP	100

- Add appropriate failure rate
- Add appropriate termination finish
- Capacitance Tolerance

Military Type Designation 1/	Capacitance in pF	Capacitance tolerance	Rated temperature and voltage-temperature limits	WVDC
<b>AVX Style 0805/CDR31 (BP) cont'd</b>				
CDR32BP101B--	100	FJ,K	BP	100
CDR32BP111B--	110	FJ,K	BP	100
CDR32BP121B--	120	FJ,K	BP	100
CDR32BP131B--	130	FJ,K	BP	100
CDR32BP151B--	150	FJ,K	BP	100
CDR32BP161B--	160	FJ,K	BP	100
CDR32BP181B--	180	F,J,K	BP	100
CDR32BP201B--	200	FJ,K	BP	100
CDR32BP221B--	220	F,J,K	BP	100
CDR32BP241B--	240	FJ,K	BP	100
CDR32BP271B--	270	FJ,K	BP	100
CDR32BP301B--	300	F,J,K	BP	100
CDR32BP331B--	330	FJ,K	BP	100
CDR32BP361B--	360	F,J,K	BP	100
CDR32BP391B--	390	FJ,K	BP	100
CDR32BP431B--	430	FJ,K	BP	100
CDR32BP471B--	470	F,J,K	BP	100
CDR32BP511B--	510	FJ,K	BP	100
CDR32BP561B--	560	F,J,K	BP	100
CDR32BP621B--	620	FJ,K	BP	100
CDR32BP681B--	680	FJ,K	BP	100
CDR32BP751B--	750	F,J,K	BP	100
CDR32BP821B--	820	FJ,K	BP	100
CDR32BP911B--	910	F,J,K	BP	100
CDR32BP102B--	1,000	FJ,K	BP	100
CDR32BP112A--	1,100	FJ,K	BP	50
CDR32BP122A--	1,200	F,J,K	BP	50
CDR32BP132A--	1,300	FJ,K	BP	50
CDR32BP152A--	1,500	F,J,K	BP	50
CDR32BP162A--	1,600	FJ,K	BP	50
CDR32BP182A--	1,800	FJ,K	BP	50
CDR32BP202A--	2,000	F,J,K	BP	50
CDR32BP222A--	2,200	FJ,K	BP	50
<b>AVX Style 1206/CDR32 (BX)</b>				
CDR32BX472B--	4,700	K,M	BX	100
CDR32BX562B--	5,600	K,M	BX	100
CDR32BX682B--	6,800	K,M	BX	100
CDR32BX822B--	8,200	K,M	BX	100
CDR32BX103B--	10,000	K,M	BX	100
CDR32BX123B--	12,000	K,M	BX	100
CDR32BX153B--	15,000	K,M	BX	100
CDR32BX183A--	18,000	K,M	BX	50
CDR32BX223A--	22,000	K,M	BX	50
CDR32BX273A--	27,000	K,M	BX	50
CDR32BX333A--	33,000	K,M	BX	50
CDR32BX393A--	39,000	K,M	BX	50

- Add appropriate failure rate
- Add appropriate termination finish
- Capacitance Tolerance

1/ The complete part number will include additional symbols to indicate capacitance tolerance, termination and failure rate level.

### CDR33/34/35 to MIL-PRF-55681/9/10/11

Military Type Designation 1/	Capacitance in pF	Capacitance tolerance	Rated temperature and voltage-temperature limits	WVDC
<b>AVX Style 1210/CDR33 (BP)</b>				
CDR33BP102B--	1,000	F,J,K	BP	100
CDR33BP112B--	1,100	F,J,K	BP	100
CDR33BP122B--	1,200	F,J,K	BP	100
CDR33BP132B--	1,300	F,J,K	BP	100
CDR33BP152B--	1,500	F,J,K	BP	100
CDR33BP162B--	1,600	F,J,K	BP	100
CDR33BP182B--	1,800	F,J,K	BP	100
CDR33BP202B--	2,000	F,J,K	BP	100
CDR33BP222B--	2,200	F,J,K	BP	100
CDR33BP242A--	2,400	F,J,K	BP	50
CDR33BP272A--	2,700	F,J,K	BP	50
CDR33BP302A--	3,000	F,J,K	BP	50
CDR33BP332A--	3,300	F,J,K	BP	50
<b>AVX Style 1210/CDR33 (BX)</b>				
CDR33BX153B--	15,000	K,M	BX	100
CDR33BX183B--	18,000	K,M	BX	100
CDR33BX223B--	22,000	K,M	BX	100
CDR33BX273B--	27,000	K,M	BX	100
CDR33BX393A--	39,000	K,M	BX	50
CDR33BX473A--	47,000	K,M	BX	50
CDR33BX563A--	56,000	K,M	BX	50
CDR33BX683A--	68,000	K,M	BX	50
CDR33BX823A--	82,000	K,M	BX	50
CDR33BX104A--	100,000	K,M	BX	50
<b>AVX Style 1812/CDR34 (BP)</b>				
CDR34BP222B--	2,200	F,J,K	BP	100
CDR34BP242B--	2,400	F,J,K	BP	100
CDR34BP272B--	2,700	F,J,K	BP	100
CDR34BP302B--	3,000	F,J,K	BP	100
CDR34BP332B--	3,300	F,J,K	BP	100
CDR34BP362B--	3,600	F,J,K	BP	100
CDR34BP392B--	3,900	F,J,K	BP	100
CDR34BP432B--	4,300	F,J,K	BP	100
CDR34BP472B--	4,700	F,J,K	BP	100
CDR34BP512A--	5,100	F,J,K	BP	50
CDR34BP562A--	5,600	F,J,K	BP	50
CDR34BP622A--	6,200	F,J,K	BP	50
CDR34BP682A--	6,800	F,J,K	BP	50
CDR34BP752A--	7,500	F,J,K	BP	50
CDR34BP822A--	8,200	F,J,K	BP	50
CDR34BP912A--	9,100	F,J,K	BP	50
CDR34BP103A--	10,000	F,J,K	BP	50

- Add appropriate failure rate
- Add appropriate termination finish
- Capacitance Tolerance

Military Type Designation 1/	Capacitance in pF	Capacitance tolerance	Rated temperature and voltage-temperature limits	WVDC
<b>AVX Style 1812/CDR34 (BX)</b>				
CDR34BX273B--	27,000	K,M	BX	100
CDR34BX333B--	33,000	K,M	BX	100
CDR34BX393B--	39,000	K,M	BX	100
CDR34BX473B--	47,000	K,M	BX	100
CDR34BX563B--	56,000	K,M	BX	100
CDR34BX104A--	100,000	K,M	BX	50
CDR34BX124A--	120,000	K,M	BX	50
CDR34BX154A--	150,000	K,M	BX	50
CDR34BX184A--	180,000	K,M	BX	50
<b>AVX Style 1825/CDR35 (BP)</b>				
CDR35BP472B--	4,700	F,J,K	BP	100
CDR35BP512B--	5,100	F,J,K	BP	100
CDR35BP562B--	5,600	F,J,K	BP	100
CDR35BP622B--	6,200	F,J,K	BP	100
CDR35BP682B--	6,800	F,J,K	BP	100
CDR35BP752B--	7,500	F,J,K	BP	100
CDR35BP822B--	8,200	F,J,K	BP	100
CDR35BP912B--	9,100	F,J,K	BP	100
CDR35BP103B--	10,000	F,J,K	BP	100
CDR35BP113A--	11,000	F,J,K	BP	50
CDR35BP123A--	12,000	F,J,K	BP	50
CDR35BP133A--	13,000	F,J,K	BP	50
CDR35BP153A--	15,000	F,J,K	BP	50
CDR35BP163A--	16,000	F,J,K	BP	50
CDR35BP183A--	18,000	F,J,K	BP	50
CDR35BP203A--	20,000	F,J,K	BP	50
CDR35BP223A--	22,000	F,J,K	BP	50
<b>AVX Style 1825/CDR35 (BX)</b>				
CDR35BX563B--	56,000	K,M	BX	100
CDR35BX683B--	68,000	K,M	BX	100
CDR35BX823B--	82,000	K,M	BX	100
CDR35BX104B--	100,000	K,M	BX	100
CDR35BX124B--	120,000	K,M	BX	100
CDR35BX154B--	150,000	K,M	BX	100
CDR35BX184A--	180,000	K,M	BX	50
CDR35BX224A--	220,000	K,M	BX	50
CDR35BX274A--	270,000	K,M	BX	50
CDR35BX334A--	330,000	K,M	BX	50
CDR35BX394A--	390,000	K,M	BX	50
CDR35BX474A--	470,000	K,M	BX	50

- Add appropriate failure rate
- Add appropriate termination finish
- Capacitance Tolerance

1/ The complete part number will include additional symbols to indicate capacitance tolerance, termination and failure rate level.

# MLCC Medical Applications – MM Series



## General Specifications



The AVX MM series is a multi-layer ceramic capacitor designed for use in medical applications other than implantable/life support. These components have the design & change control expected for medical devices and also offer enhanced LAT including reliability testing and 100% inspection.

### APPLICATIONS

#### Implantable, Non-Life Supporting Medical Devices

- e.g. implanted temporary cardiac monitor, insulin pumps

#### External, Life Supporting Medical Devices

- e.g. heart pump external controller

#### External Devices

- e.g. patient monitoring, diagnostic equipment

### HOW TO ORDER

<b>MM02</b>	<b>Z</b>	<b>A</b>	<b>100</b>	<b>J</b>	<b>G</b>	<b>T</b>	<b>3</b>	<b>A</b>
Size	Rated Voltage	Dielectric Code	Capacitance Code (In pF)	Capacitance Tolerance	Failure Rate	Termination Finish	Packaging	Special Code
MM02 = 0402 MM03 = 0603 MM05 = 0805 MM06 = 1206 MM10 = 1210 MM08 = 1808 MM12 = 1812 MM20 = 2220	Z = 10V Y = 16V 3 = 25V 5 = 50V 1 = 100V 2 = 200V V = 250V 7 = 500V	A = NP0 (COG) C = X7R	(2 significant digits + number of zeros) <b>for values &lt;10pF:</b> letter R denotes decimal point. Example: 68pF = 680 8.2pF = 8R2	B = ±0.1pF C = ±0.25pF D = ±0.5pF F = ±1% (≥10pF) G = ±2% (≥10pF) J = ±5% K = ±10% M = ±20%	C = Standard Range  Contact AVX for others	T = Plated Ni & Sn (NP0 only) Z = Flexiterm (X7R only)	2 = 7" Reel 4 = 13" Reel	A = Standard  Contact AVX for others

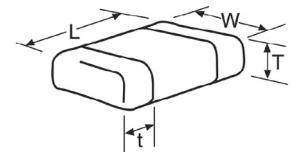

### COMMERCIAL VS MM SERIES PROCESS COMPARISON

	Commercial	MM Series
<b>Administrative</b>	Standard part numbers; no restriction on who purchases these parts	Specific series part number, used to control supply of product
<b>Design</b>	Minimum ceramic thickness of 0.020" on all X7R product	Minimum ceramic thickness of 0.029" (0.74mm)
<b>Dicing</b>	Side & end margins = 0.003" min	Side & end margins = 0.004" min Cover layers = 0.003" min
<b>Lot Qualification Destructive Physical Analysis (DPA)</b>	As per EIA RS469	Increased sample plan – stricter criteria
<b>Visual/Cosmetic Quality</b>	Standard process and inspection	100% inspection
<b>Application Robustness</b>	Standard sampling for accelerated wave solder on X7R dielectrics	Increased sampling for accelerated wave solder on X7R and NP0 followed by lot by lot reliability testing
<b>Design/Change Control</b>	Required to inform customer of changes in: <ul style="list-style-type: none"> <li>• form</li> <li>• fit</li> <li>• function</li> </ul>	AVX will qualify and notify customers before making any change to the following materials or processes: <ul style="list-style-type: none"> <li>• Dielectric formulation, type, or supplier</li> <li>• Metal formulation, type, or supplier</li> <li>• Termination material formulation, type, or supplier</li> <li>• Manufacturing equipment type</li> <li>• Quality testing regime including sample size and accept/ reject criteria</li> </ul>

# MM Series – MLCC for Medical Applications

## NPO (COG) – Specifications & Test Methods

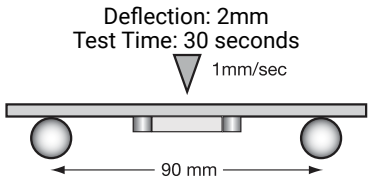

Parameter/Test		NPO Specification Limits	Measuring Conditions	
<b>Operating Temperature Range</b>		-55°C to +125°C	Temperature Cycle Chamber	
<b>Capacitance</b>		Within specified tolerance	Freq.: 1.0 MHz ± 10% for cap ≤ 1000 pF 1.0 kHz ± 10% for cap > 1000 pF Voltage: 1.0Vrms ± .2V	
<b>Q</b>		<30 pF: Q ≥ 400+20 x Cap Value ≥30 pF: Q ≥ 1000		
<b>Insulation Resistance</b>		100,000MΩ or 1000MΩ - μF, whichever is less	Charge device with rated voltage for 60 ± 5 secs @ room temp/humidity	
<b>Dielectric Strength</b>		No breakdown or visual defects	Charge device with 300% of rated voltage for 1-5 seconds, w/charge and discharge current limited to 50 mA (max) Note: Charge device with 150% of rated voltage for 500V devices.	
<b>Resistance to Flexure Stresses</b>	Appearance	No defects	Deflection: 2mm Test Time: 30 seconds 	
	Capacitance Variation	±5% or ±.5 pF, whichever is greater		
	Q	Meets Initial Values (As Above)		
	Insulation Resistance	≥ Initial Value x 0.3		
<b>Solderability</b>		≥ 95% of each terminal should be covered with fresh solder	Dip device in eutectic solder at 230 ± 5°C for 5.0 ± 0.5 seconds	
<b>Resistance to Solder Heat</b>	Appearance	No defects, <25% leaching of either end terminal	Dip device in eutectic solder at 260°C for 60 seconds. Store at room temperature for 24 ± 2 hours before measuring electrical properties.	
	Capacitance Variation	≤ ±2.5% or ±.25 pF, whichever is greater		
	Q	Meets Initial Values (As Above)		
	Insulation Resistance	Meets Initial Values (As Above)		
	Dielectric Strength	Meets Initial Values (As Above)		
<b>Thermal Shock</b>	Appearance	No visual defects	Step 1: -55°C ± 2°	30 ± 3 minutes
	Capacitance Variation	≤ ±2.5% or ±.25 pF, whichever is greater	Step 2: Room Temp	≤ 3 minutes
	Q	Meets Initial Values (As Above)	Step 3: +125°C ± 2°	30 ± 3 minutes
	Insulation Resistance	Meets Initial Values (As Above)	Step 4: Room Temp	≤ 3 minutes
	Dielectric Strength	Meets Initial Values (As Above)	Repeat for 5 cycles and measure after 24 hours at room temperature	
<b>Load Life</b>	Appearance	No visual defects	Charge device with twice rated voltage in test chamber set at 125°C ± 2°C for 1000 hours (+48, -0).  Remove from test chamber and stabilize at room temperature for 24 hours before measuring.	
	Capacitance Variation	≤ ±3.0% or ± .3 pF, whichever is greater		
	Q	≥ 30 pF: Q ≥ 350 ≥10 pF, <30 pF: Q ≥ 275 +5C/2 <10 pF: Q ≥ 200 +10C		
	Insulation Resistance	≥ Initial Value x 0.3 (See Above)		
	Dielectric Strength	Meets Initial Values (As Above)		
<b>Load Humidity</b>	Appearance	No visual defects	Store in a test chamber set at 85°C ± 2°C/ 85% ± 5% relative humidity for 1000 hours (+48, -0) with rated voltage applied.  Remove from chamber and stabilize at room temperature for 24 ± 2 hours before measuring.	
	Capacitance Variation	≤ ±5.0% or ± .5 pF, whichever is greater		
	Q	≥ 30 pF: Q ≥ 350 ≥10 pF, <30 pF: Q ≥ 275 +5C/2 <10 pF: Q ≥ 200 +10C		
	Insulation Resistance	≥ Initial Value x 0.3 (See Above)		
	Dielectric Strength	Meets Initial Values (As Above)		

# MM Series – MLCC for Medical Applications

## NP0/COG Capacitance Range



PREFERRED SIZES ARE SHADED

SIZE			0603				0805				1206			
WVDC			16	25	50	100	16	25	50	100	16	25	50	100
Cap	0.5	0R5												
(pF)	1.0	1R0												
	1.2	1R2												
	1.5	1R5												
	1.8	1R8												
	2.2	2R2												
	2.7	2R7												
	3.3	3R3												
	3.9	3R9												
	4.7	4R7												
	5.6	5R6												
	6.8	6R8												
	8.2	8R2												
	10	100												
	12	120												
	15	150												
	18	180												
	22	220												
	27	270												
	33	330												
	39	390												
	47	470												
	56	560												
	68	680												
	82	820												
	100	101												
	120	121												
	150	151												
	180	181												
	220	221												
	270	271												
	330	331												
	390	391												
	470	471												
	560	561												
	680	681												
	820	821												
	1000	102												
	1200	122												
	1500	152												
WVDC			16	25	50	100	16	25	50	100	16	25	50	100
SIZE			0603				0805				1206			

# MM Series – MLCC for Medical Applications



## X7R Specifications and Test Methods

Parameter/Test		X7R Specification Limits	Measuring Conditions	
<b>Operating Temperature Range</b>		-55°C to +125°C	Temperature Cycle Chamber	
<b>Capacitance</b>		Within specified tolerance	Freq.: 1.0 kHz ± 10% Voltage: 1.0Vrms ± .2V	
<b>Q</b>	$\leq 10\%$ for $\geq 50V$ DC rating $\leq 12.5\%$ for 25V DC rating $\leq 12.5\%$ for 25V and 16V DC rating $\leq 12.5\%$ for $\leq 10V$ DC rating			
<b>Insulation Resistance</b>		100,000MΩ or 1000MΩ - μF, whichever is less	Charge device with rated voltage for 120 ± 5 secs @ room temp/humidity	
<b>Dielectric Strength</b>		No breakdown or visual defects	Charge device with 300% of rated voltage for 1-5 seconds, w/charge and discharge current limited to 50 mA (max) Note: Charge device with 150% of rated voltage for 500V devices.	
<b>Resistance to Flexure Stresses</b>	Appearance	No defects	Deflection: 2mm Test Time: 30 seconds 	
	Capacitance Variation	$\leq \pm 12\%$		
	Dissipation Factor	Meets Initial Values (As Above)		
	Insulation Resistance	$\geq$ Initial Value x 0.3		
<b>Solderability</b>		$\geq 95\%$ of each terminal should be covered with fresh solder	Dip device in eutectic solder at 230 ± 5°C for 5.0 ± 0.5 seconds	
<b>Resistance to Solder Heat</b>	Appearance	No defects, <25% leaching of either end terminal	Dip device in eutectic solder at 260°C for 60 seconds. Store at room temperature for 24 ± 2 hours before measuring electrical properties.	
	Capacitance Variation	$\leq \pm 7.5\%$		
	Dissipation Factor	Meets Initial Values (As Above)		
	Insulation Resistance	Meets Initial Values (As Above)		
	Dielectric Strength	Meets Initial Values (As Above)		
<b>Thermal Shock</b>	Appearance	No visual defects	Step 1: -55°C ± 2°	30 ± 3 minutes
	Capacitance Variation	$\leq \pm 7.5\%$	Step 2: Room Temp	$\leq 3$ minutes
	Dissipation Factor	Meets Initial Values (As Above)	Step 3: +125°C ± 2°	30 ± 3 minutes
	Insulation Resistance	Meets Initial Values (As Above)	Step 4: Room Temp	$\leq 3$ minutes
	Dielectric Strength	Meets Initial Values (As Above)	Repeat for 5 cycles and measure after 24 ± 2 hours at room temperature	
<b>Load Life</b>	Appearance	No visual defects	Charge device with 1.5 rated voltage ( $\leq 10V$ ) in test chamber set at 125°C ± 2°C for 1000 hours (+48, -0)  Remove from test chamber and stabilize at room temperature for 24 ± 2 hours before measuring.	
	Capacitance Variation	$\leq \pm 12.5\%$		
	Dissipation Factor	$\leq$ Initial Value x 2.0 (See Above)		
	Insulation Resistance	$\geq$ Initial Value x 0.3 (See Above)		
	Dielectric Strength	Meets Initial Values (As Above)		
<b>Load Humidity</b>	Appearance	No visual defects	Store in a test chamber set at 85°C ± 2°C/ 85% ± 5% relative humidity for 1000 hours (+48, -0) with rated voltage applied.  Remove from chamber and stabilize at room temperature and humidity for 24 ± 2 hours before measuring.	
	Capacitance Variation	$\leq \pm 12.5\%$		
	Dissipation Factor	$\leq$ Initial Value x 2.0 (See Above)		
	Insulation Resistance	$\geq$ Initial Value x 0.3 (See Above)		
	Dielectric Strength	Meets Initial Values (As Above)		



# Packaging of Chip Components

## Automatic Insertion Packaging



### TAPE & REEL QUANTITIES

All tape and reel specifications are in compliance with RS481.

	4mm	8mm	12mm	
Paper or Embossed Carrier		0612, 0508, 0805, 1206, 1210		
Embossed Only	0101		1808	1812, 1825, 2220, 2225
Paper Only		0101, 0201, 0306, 0402, 0603		
Qty. per Reel/7" Reel	4,000	1,000, 2,000, 3,000 or 4,000, 10,000, 15,000, 20,000 Contact factory for exact quantity	3,000	500, 1,000 Contact factory for exact quantity
Qty. per Reel/13" Reel		5,000, 10,000, 50,000 Contact factory for exact quantity	10,000	4,000

### REEL DIMENSIONS



Tape Size <sup>(1)</sup>	A Max.	B* Min.	C	D* Min.	N Min.	W <sub>1</sub>	W <sub>2</sub> Max.	W <sub>3</sub>
4mm	1.80 (7.087)	1.5 (0.059)	13.0±0.5 (0.522±0.020)	20.2 (0.795)	60.0 (2.362)	4.35±0.3 (0.171±0.011)	7.95 (0.312)	
8mm						8.40 <sup>+1.5</sup> <sub>-0.0</sub> (0.331 <sup>+0.059</sup> <sub>-0.0</sub> )	14.4 (0.567)	7.90 Min. (0.311) 10.9 Max. (0.429)
12mm	330 (12.992)	1.5 (0.059)	13.0 <sup>+0.50</sup> <sub>-0.20</sub> (0.512 <sup>+0.020</sup> <sub>-0.008</sub> )	20.2 (0.795)	50.0 (1.969)	12.4 <sup>+2.0</sup> <sub>-0.0</sub> (0.488 <sup>+0.079</sup> <sub>-0.0</sub> )	18.4 (0.724)	11.9 Min. (0.469) 15.4 Max. (0.607)

Metric dimensions will govern.

English measurements rounded and for reference only.

(1) For tape sizes 16mm and 24mm (used with chip size 3640) consult EIA RS-481 latest revision.

# Embossed Carrier Configuration



## 4, 8 & 12mm Tape Only

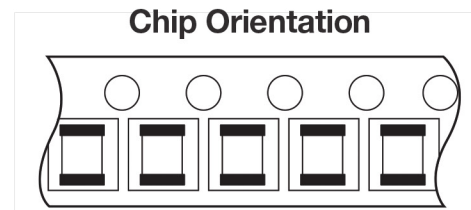

## 4, 8 & 12mm Embossed Tape Metric Dimensions Will Govern

### CONSTANT DIMENSIONS

Tape Size	D <sub>0</sub>	E <sub>1</sub>	P <sub>0</sub>	P <sub>2</sub>	S <sub>1</sub> Min.	T Max.	T <sub>1</sub> Max.
4mm	0.80±0.04 (0.031±0.001)	0.90±0.05 (0.035±0.001)	2.0±0.04 (0.078±0.001)	1.00±0.02 (0.039±0.0007)	1.075 (0.042)	0.26 (0.010)	0.06 (0.002)
8mm & 12mm	1.50 <sup>+0.10</sup> <sub>-0.0</sub> (0.059 <sup>+0.004</sup> <sub>-0.0</sub> )	1.75 ± 0.10 (0.069 ± 0.004)	4.0 ± 0.10 (0.157 ± 0.004)	2.0 ± 0.05 (0.079 ± 0.002)	0.60 (0.024)	0.60 (0.024)	0.10 (0.004)

### VARIABLE DIMENSIONS

Tape Size	B <sub>1</sub> Max.	D <sub>1</sub> Min.	E <sub>2</sub> Min.	F	P <sub>1</sub> See Note 5	R Min. See Note 2	T <sub>2</sub>	W Max.	A <sub>0</sub> B <sub>0</sub> K <sub>0</sub>
8mm	4.35 (0.171)	1.00 (0.039)	6.25 (0.246)	3.50 ± 0.05 (0.138 ± 0.002)	4.00 ± 0.10 (0.157 ± 0.004)	25.0 (0.984)	2.50 Max. (0.098)	8.30 (0.327)	See Note 1
12mm	8.20 (0.323)	1.50 (0.059)	10.25 (0.404)	5.50 ± 0.05 (0.217 ± 0.002)	4.00 ± 0.10 (0.157 ± 0.004)	30.0 (1.181)	6.50 Max. (0.256)	12.3 (0.484)	See Note 1
8mm 1/2 Pitch	4.35 (0.171)	1.00 (0.039)	6.25 (0.246)	3.50 ± 0.05 (0.138 ± 0.002)	2.00 ± 0.10 (0.079 ± 0.004)	25.0 (0.984)	2.50 Max. (0.098)	8.30 (0.327)	See Note 1
12mm Double Pitch	8.20 (0.323)	1.50 (0.059)	10.25 (0.404)	5.50 ± 0.05 (0.217 ± 0.002)	8.00 ± 0.10 (0.315 ± 0.004)	30.0 (1.181)	6.50 Max. (0.256)	12.3 (0.484)	See Note 1

#### NOTES:

- The cavity defined by A<sub>0</sub>, B<sub>0</sub>, and K<sub>0</sub> shall be configured to provide the following:
  - Surround the component with sufficient clearance such that:
    - the component does not protrude beyond the sealing plane of the cover tape.
    - the component can be removed from the cavity in a vertical direction without mechanical restriction, after the cover tape has been removed.
    - rotation of the component is limited to 20° maximum (see Sketches D & E).
    - lateral movement of the component is restricted to 0.5mm maximum (see Sketch F).

- Tape with or without components shall pass around radius "R" without damage.
- Bar code labeling (if required) shall be on the side of the reel opposite the round sprocket holes. Refer to EIA-556.
- B<sub>1</sub> dimension is a reference dimension for tape feeder clearance only.
- If P<sub>1</sub> = 2.0mm, the tape may not properly index in all tape feeders.

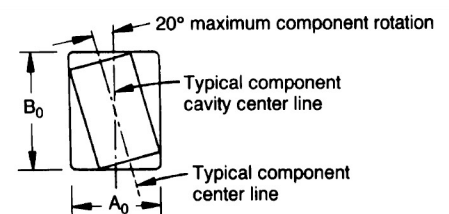
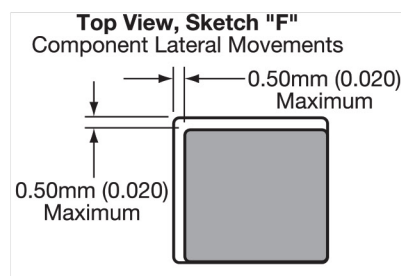
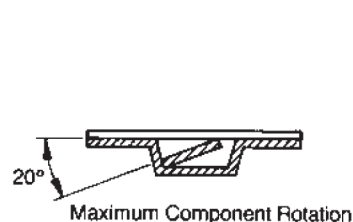

# Paper Carrier Configuration

8 & 12mm Tape Only



## 4, 8 & 12mm Embossed Tape Metric Dimensions Will Govern

### CONSTANT DIMENSIONS

Tape Size	D <sub>0</sub>	E	P <sub>0</sub>	P <sub>2</sub>	T <sub>1</sub>	G. Min.	R Min.
8mm and 12mm	1.50 <sup>+0.10</sup> <sub>-0.0</sub> (0.059 <sup>+0.004</sup> <sub>-0.0</sub> )	1.75 ± 0.10 (0.069 ± 0.004)	4.00 ± 0.10 (0.157 ± 0.004)	2.00 ± 0.05 (0.079 ± 0.002)	0.10 (0.004) Max.	0.75 (0.030) Min.	25.0 (0.984) See Note 2 Min.

### VARIABLE DIMENSIONS

Tape Size	P <sub>1</sub> See Note 4	E <sub>2</sub> Min.	F	W	A <sub>0</sub> B <sub>0</sub>	T
8mm	4.00 ± 0.10 (0.157 ± 0.004)	6.25 (0.246)	3.50 ± 0.05 (0.138 ± 0.002)	8.00 <sup>+0.30</sup> <sub>-0.10</sub> (0.315 <sup>+0.012</sup> <sub>-0.004</sub> )	See Note 1	1.10mm (0.043) Max. for Paper Base Tape and
12mm	4.00 ± 0.10 (0.157 ± 0.004)	10.25 (0.404)	5.50 ± 0.05 (0.217 ± 0.002)	12.0 ± 0.30 (0.472 ± 0.012)		
8mm 1/2 Pitch	2.00 ± 0.05 (0.079 ± 0.002)	6.25 (0.246)	3.50 ± 0.05 (0.138 ± 0.002)	8.00 <sup>+0.30</sup> <sub>-0.10</sub> (0.315 <sup>+0.012</sup> <sub>-0.004</sub> )	See Note 1	1.60mm (0.063) Max. for Non- Paper Base Compositions
12mm Double Pitch	8.00 ± 0.10 (0.315 ± 0.004)	10.25 (0.404)	5.50 ± 0.05 (0.217 ± 0.002)	12.0 ± 0.30 (0.472 ± 0.012)		

#### NOTES:

- The cavity defined by A<sub>0</sub>, B<sub>0</sub>, and T shall be configured to provide sufficient clearance surrounding the component so that:
  - the component does not protrude beyond either surface of the carrier tape;
  - the component can be removed from the cavity in a vertical direction without mechanical restriction after the top cover tape has been removed;
  - rotation of the component is limited to 20° maximum (see Sketches A & B);
  - lateral movement of the component is restricted to 0.5mm maximum (see Sketch C).
- Tape with or without components shall pass around radius "R" without damage.
- Bar code labeling (if required) shall be on the side of the reel opposite the sprocket holes. Refer to EIA-556.
- If P<sub>1</sub> = 2.0mm, the tape may not properly index in all tape feeders.

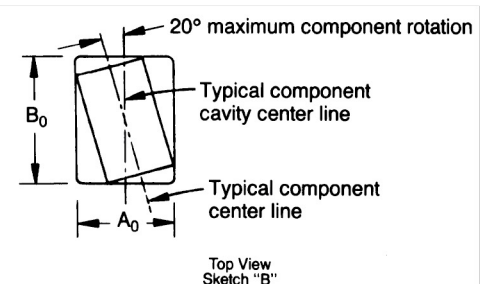
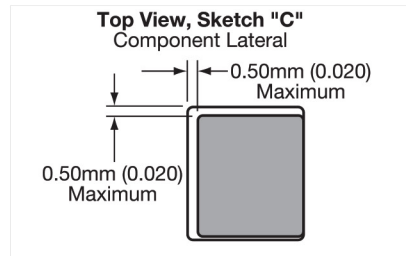
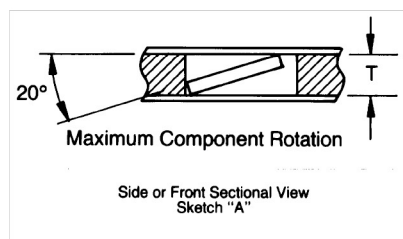

## Bar Code Labeling Standard

AVX bar code labeling is available and follows latest version of EIA-556



# Basic Capacitor Formulas

## I. Capacitance (farads)

$$\text{English: } C = \frac{.224 \text{ K A}}{T_D}$$

$$\text{Metric: } C = \frac{.0884 \text{ K A}}{T_D}$$

## II. Energy stored in capacitors (Joules, watt - sec)

$$E = \frac{1}{2} CV^2$$

## III. Linear charge of a capacitor (Amperes)

$$I = C \frac{dV}{dt}$$

## IV. Total Impedance of a capacitor (ohms)

$$Z = \sqrt{R_S^2 + (X_C - X_L)^2}$$

## V. Capacitive Reactance (ohms)

$$X_C = \frac{1}{2 \pi fC}$$

## VI. Inductive Reactance (ohms)

$$X_L = 2 \pi fL$$

## VII. Phase Angles:

Ideal Capacitors: Current leads voltage 90°

Ideal Inductors: Current lags voltage 90°

Ideal Resistors: Current in phase with voltage

## VIII. Dissipation Factor (%)

$$D.F. = \tan \delta \text{ (loss angle)} = \frac{E.S.R.}{X_C} = (2 \pi fC) (E.S.R.)$$

## IX. Power Factor (%)

P.F. = Sine (loss angle) = Cos  $\phi$  (phase angle)

P.F. = (when less than 10%) = DF

## X. Quality Factor (dimensionless)

$$Q = \text{Cotan } \delta \text{ (loss angle)} = \frac{1}{D.F.}$$

## XI. Equivalent Series Resistance (ohms)

$$E.S.R. = (D.F.) (X_C) = (D.F.) / (2 \pi fC)$$

## XII. Power Loss (watts)

$$\text{Power Loss} = (2 \pi fCV^2) (D.F.)$$

## XIII. KVA (Kilowatts)

$$KVA = 2 \pi fCV^2 \times 10^{-3}$$

## XIV. Temperature Characteristic (ppm/°C)

$$T.C. = \frac{C_t - C_{25}}{C_{25} (T_t - 25)} \times 10^6$$

## XV. Cap Drift (%)

$$C.D. = \frac{C_1 - C_2}{C_1} \times 100$$

## XVI. Reliability of Ceramic Capacitors

$$L_0 = \left( \frac{V_t}{V_0} \right)^X \left( \frac{T_t}{T_0} \right)^Y$$

## XVII. Capacitors in Series (current the same)

$$\text{Any Number: } \frac{1}{C_T} = \frac{1}{C_1} + \frac{1}{C_2} \dots \frac{1}{C_N}$$

$$\text{Two: } C_T = \frac{C_1 C_2}{C_1 + C_2}$$

## XVIII. Capacitors in Parallel (voltage the same)

$$C_T = C_1 + C_2 \dots + C_N$$

## XIX. Aging Rate

A.R. = % $\Delta$  C/decade of time

## XX. Decibels

$$db = 20 \log \frac{V_1}{V_2}$$

## METRIC PREFIXES

Pico	X 10 <sup>-12</sup>
Nano	X 10 <sup>-9</sup>
Micro	X 10 <sup>-6</sup>
Milli	X 10 <sup>-3</sup>
Deci	X 10 <sup>-1</sup>
Deca	X 10 <sup>+1</sup>
Kilo	X 10 <sup>+3</sup>
Mega	X 10 <sup>+6</sup>
Giga	X 10 <sup>+9</sup>
Tera	X 10 <sup>+12</sup>

## SYMBOLS

K	= Dielectric Constant	f	= frequency	L <sub>t</sub>	= Test life
A	= Area	L	= Inductance	V <sub>t</sub>	= Test voltage
T <sub>D</sub>	= Dielectric thickness	$\delta$	= Loss angle	V <sub>o</sub>	= Operating voltage
V	= Voltage	$\phi$	= Phase angle	T <sub>t</sub>	= Test temperature
t	= time	X & Y	= exponent effect of voltage and temp.	T <sub>o</sub>	= Operating temperature
R <sub>s</sub>	= Series Resistance	L <sub>o</sub>	= Operating life		

## General Description

**Basic Construction** – A multilayer ceramic (MLC) capacitor is a monolithic block of ceramic containing two sets of offset, interleaved planar electrodes that extend to two opposite surfaces of the ceramic dielectric. This simple structure requires a considerable amount of sophistication, both in material and manufacture, to produce it in the

quality and quantities needed in today's electronic equipment.



**Formulations** – Multilayer ceramic capacitors are available in both Class 1 and Class 2 formulations. Temperature compensating formulations are Class 1 and temperature stable and general application formulations are classified as Class 2.

**Class 1** – Class 1 capacitors or temperature compensating capacitors are usually made from mixtures of titanates where barium titanate is normally not a major part of the mix. They have predictable temperature coefficients and in general, do not have an aging characteristic. Thus they are the most stable capacitor available. The most popular Class 1 multilayer ceramic capacitors are COG (NP0) temperature compensating capacitors (negative-positive 0 ppm/°C).

**Class 2** – EIA Class 2 capacitors typically are based on the chemistry of barium titanate and provide a wide range of capacitance values and temperature stability. The most commonly used Class 2 dielectrics are X7R and Y5V. The X7R provides intermediate capacitance values which vary only  $\pm 15\%$  over the temperature range of  $-55^{\circ}\text{C}$  to  $125^{\circ}\text{C}$ . It finds applications where stability over a wide temperature range is required. The Y5V provides the highest capacitance values and is used in applications where limited temperature changes are expected. The capacitance value for Y5V can vary from 22% to -82% over the  $-30^{\circ}\text{C}$  to  $85^{\circ}\text{C}$  temperature range.

All Class 2 capacitors vary in capacitance value under the influence of temperature, operating voltage (both AC and DC), and frequency. For additional information on performance changes with operating conditions, consult AVX's software, SpiCap.

# General Description

**Table 1: EIA and MIL Temperature Stable and General Application Codes**

EIA CODE	
Percent Capacity Change Over Temperature Range	
RS198	Temperature Range
X7	-55°C to +125°C
X6	-55°C to +105°C
X5	-55°C to +85°C
Y5	-30°C to +85°C
Z5	+10°C to +85°C
Code	Percent Capacity Change
D	±3.3%
E	±4.7%
F	±7.5%
P	±10%
R	±15%
S	±22%
T	+22%, -33%
U	+22%, -56%
V	+22%, -82%

EXAMPLE – A capacitor is desired with the capacitance value at 25°C to increase no more than 7.5% or decrease no more than 7.5% from -30°C to +85°C. EIA Code will be Y5F.

MIL CODE		
Symbol	Temperature Range	
A	-55°C to +85°C	
B	-55°C to +125°C	
C	-55°C to +150°C	
Symbol	Cap. Change Zero Volts	Cap. Change Rated Volts
R	+15%, -15%	+15%, -40%
S	+22%, -22%	+22%, -56%
W	+22%, -56%	+22%, -66%
X	+15%, -15%	+15%, -25%
Y	+30%, -70%	+30%, -80%
Z	+20%, -20%	+20%, -30%

Temperature characteristic is specified by combining range and change symbols, for example BR or AW. Specification slash sheets indicate the characteristic applicable to a given style of capacitor.

In specifying capacitance change with temperature for Class 2 materials, EIA expresses the capacitance change over an operating temperature range by a 3 symbol code. The first symbol represents the cold temperature end of the temperature range, the second represents the upper limit of the operating temperature range and the third symbol represents the capacitance change allowed over the operating temperature range. Table 1 provides a detailed explanation of the EIA system.

**Effects of Voltage** – Variations in voltage have little effect on Class 1 dielectric but does affect the capacitance and dissipation factor of Class 2 dielectrics. The application of DC voltage reduces both the capacitance and dissipation factor while the application of an AC voltage within a reasonable range tends to increase both capacitance and dissipation factor readings. If a high enough AC voltage is applied, eventually it will reduce capacitance just as a DC voltage will. Figure 2 shows the effects of AC voltage.



Figure 2

Capacitor specifications specify the AC voltage at which to measure (normally 0.5 or 1 VAC) and application of the wrong voltage can cause spurious readings. Figure 3 gives the voltage coefficient of dissipation factor for various AC voltages at 1 kilohertz. Applications of different frequencies will affect the percentage changes versus voltages.



Figure 3

Typical effect of the application of DC voltage is shown in Figure 4. The voltage coefficient is more pronounced for higher K dielectrics. These figures are shown for room temperature conditions. The combination characteristic known as voltage temperature limits which shows the effects of rated voltage over the operating temperature range is shown in Figure 5 for the military BX characteristic.

# General Description

**Typical Cap. Change vs. D.C. Volts  
X7R**

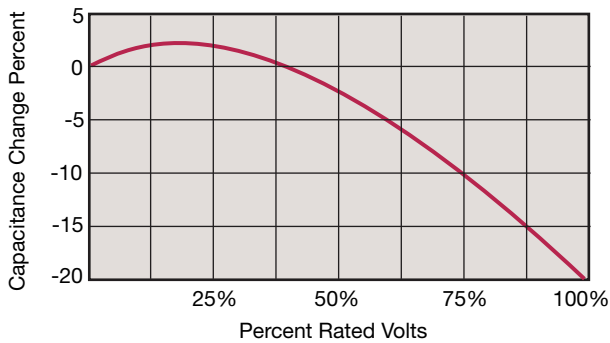

Figure 4

**Typical Cap. Change vs. Temperature  
X7R**

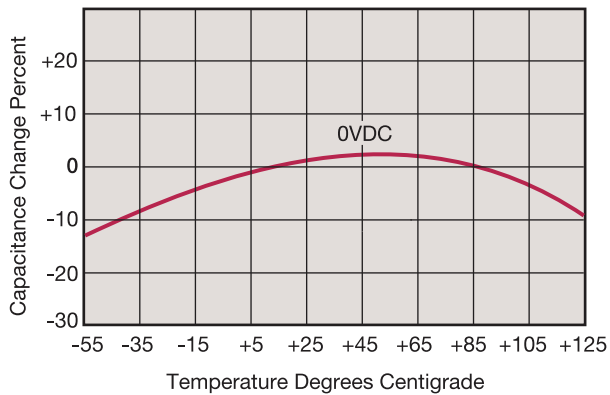

Figure 5

**Effects of Time** – Class 2 ceramic capacitors change capacitance and dissipation factor with time as well as temperature, voltage and frequency. This change with time is known as aging. Aging is caused by a gradual re-alignment of the crystalline structure of the ceramic and produces an exponential loss in capacitance and decrease in dissipation factor versus time. A typical curve of aging rate for semistable ceramics is shown in Figure 6.

If a Class 2 ceramic capacitor that has been sitting on the shelf for a period of time, is heated above its curie point, (125°C for 4 hours or 150°C for 1/2 hour will suffice) the part will de-age and return to its initial capacitance and dissipation factor readings. Because the capacitance changes rapidly, immediately after de-aging, the basic capacitance measurements are normally referred to a time period sometime after the de-aging process. Various manufacturers use different time bases but the most popular one is one day or twenty-four hours after “last heat.” Change in the aging curve can be caused by the application of voltage and other stresses. The possible changes in capacitance due to de-aging by heating the unit explain why capacitance changes are allowed after test, such as temperature cycling, moisture resistance, etc., in MIL specs. The application of high voltages such as dielectric withstanding voltages also tends to de-age capacitors and is why re-reading of capacitance after 12 or 24 hours is allowed in military specifications after dielectric strength tests have been performed.

**Typical Curve of Aging Rate  
X7R**



Characteristic	Max. Aging Rate %/Decade
C0G (NP0)	None
X7R, X5R	2
Y5V	7

Figure 6

**Effects of Frequency** – Frequency affects capacitance and impedance characteristics of capacitors. This effect is much more pronounced in high dielectric constant ceramic formulation than in low K formulations. AVX’s SpiCap software generates impedance, ESR, series inductance, series resonant frequency and capacitance all as functions of frequency, temperature and DC bias for standard chip sizes and styles. It is available free from AVX and can be downloaded for free from AVX website: [www.avx.com](http://www.avx.com).



## General Description

**Effects of Mechanical Stress** – High “K” dielectric ceramic capacitors exhibit some low level piezoelectric reactions under mechanical stress. As a general statement, the piezoelectric output is higher, the higher the dielectric constant of the ceramic. It is desirable to investigate this effect before using high “K” dielectrics as coupling capacitors in extremely low level applications.

**Reliability** – Historically ceramic capacitors have been one of the most reliable types of capacitors in use today. The approximate formula for the reliability of a ceramic capacitor is:

$$\frac{L_o}{L_t} = \left(\frac{V_t}{V_o}\right)^X \left(\frac{T_t}{T_o}\right)^Y$$

where

$L_o$ = operating life	$T_t$ = test temperature and
$L_t$ = test life	$T_o$ = operating temperature
$V_t$ = test voltage	in °C
$V_o$ = operating voltage	$X, Y$ = see text

Historically for ceramic capacitors exponent X has been considered as 3. The exponent Y for temperature effects typically tends to run about 8.

A capacitor is a component which is capable of storing electrical energy. It consists of two conductive plates (electrodes) separated by insulating material which is called the dielectric. A typical formula for determining capacitance is:

$$C = \frac{.224 KA}{t}$$

$C$ = capacitance (picofarads)
$K$ = dielectric constant (Vacuum = 1)
$A$ = area in square inches
$t$ = separation between the plates in inches (thickness of dielectric)
$.224$ = conversion constant (.0884 for metric system in cm)

**Capacitance** – The standard unit of capacitance is the farad. A capacitor has a capacitance of 1 farad when 1 coulomb charges it to 1 volt. One farad is a very large unit and most capacitors have values in the micro ( $10^{-6}$ ), nano ( $10^{-9}$ ) or pico ( $10^{-12}$ ) farad level.

**Dielectric Constant** – In the formula for capacitance given above the dielectric constant of a vacuum is arbitrarily chosen as the number 1. Dielectric constants of other materials are then compared to the dielectric constant of a vacuum.

**Dielectric Thickness** – Capacitance is indirectly proportional to the separation between electrodes. Lower voltage requirements mean thinner dielectrics and greater capacitance per volume.

**Area** – Capacitance is directly proportional to the area of the electrodes. Since the other variables in the equation are usually set by the performance desired, area is the easiest parameter to modify to obtain a specific capacitance within a material group.

**Energy Stored** – The energy which can be stored in a capacitor is given by the formula:

$$E = \frac{1}{2}CV^2$$

$E$ = energy in joules (watts-sec)
$V$ = applied voltage
$C$ = capacitance in farads

**Potential Change** – A capacitor is a reactive component which reacts against a change in potential across it. This is shown by the equation for the linear charge of a capacitor:

$$I_{ideal} = C \frac{dV}{dt}$$

where

$I$ = Current
$C$ = Capacitance

$dV/dt$  = Slope of voltage transition across capacitor

Thus an infinite current would be required to instantly change the potential across a capacitor. The amount of current a capacitor can “sink” is determined by the above equation.

**Equivalent Circuit** – A capacitor, as a practical device, exhibits not only capacitance but also resistance and inductance. A simplified schematic for the equivalent circuit is:

$C$ = Capacitance	$L$ = Inductance
$R_s$ = Series Resistance	$R_p$ = Parallel Resistance

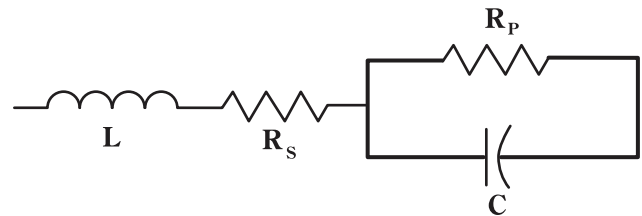

**Reactance** – Since the insulation resistance ( $R_p$ ) is normally very high, the total impedance of a capacitor is:

$$Z = \sqrt{R_s^2 + (X_c - X_L)^2}$$

where

$Z$ = Total Impedance	
$R_s$ = Series Resistance	
$X_c$ = Capacitive Reactance	$= \frac{1}{2 \pi fC}$
$X_L$ = Inductive Reactance	$= 2 \pi fL$

The variation of a capacitor’s impedance with frequency determines its effectiveness in many applications.

**Phase Angle** – Power Factor and Dissipation Factor are often confused since they are both measures of the loss in a capacitor under AC application and are often almost identical in value. In a “perfect” capacitor the current in the capacitor will lead the voltage by  $90^\circ$ .

## General Description



In practice the current leads the voltage by some other phase angle due to the series resistance  $R_s$ . The complement of this angle is called the loss angle and:

$$\text{Power Factor (P.F.)} = \cos \phi \text{ or } \sin \delta$$

$$\text{Dissipation Factor (D.F.)} = \tan \delta$$

for small values of the tan and sine are essentially equal which has led to the common interchangeability of the two terms in the industry.

**Equivalent Series Resistance** – The term E.S.R. or Equivalent Series Resistance combines all losses both series and parallel in a capacitor at a given frequency so that the equivalent circuit is reduced to a simple R-C series connection.

**Dissipation Factor** – The DF/PF of a capacitor tells what percent of the apparent power input will turn to heat in the capacitor.

$$\text{Dissipation Factor} = \frac{\text{E.S.R.}}{X_c} = (2 \pi fC) (\text{E.S.R.})$$

The watts loss are:

$$\text{Watts loss} = (2 \pi fCV^2) (\text{D.F.})$$

Very low values of dissipation factor are expressed as their reciprocal for convenience. These are called the “Q” or Quality factor of capacitors.

**Parasitic Inductance** – The parasitic inductance of capacitors is becoming more and more important in the decoupling of today’s high speed digital systems. The relationship between the inductance and the ripple voltage induced on the DC voltage line can be seen from the simple inductance equation:

$$V = L \frac{di}{dt}$$

The  $\frac{di}{dt}$  seen in current microprocessors can be as high as 0.3 A/ns, and up to 10A/ns. At 0.3 A/ns, 100pH of parasitic inductance can cause a voltage spike of 30mV. While this does not sound very drastic, with the  $V_{cc}$  for microprocessors decreasing at the current rate, this can be a fairly large percentage.

Another important, often overlooked, reason for knowing the parasitic inductance is the calculation of the resonant frequency. This can be important for high frequency, bypass capacitors, as the resonant point will give the most signal attenuation. The resonant frequency is calculated from the simple equation:

$$f_{res} = \frac{1}{2\pi\sqrt{LC}}$$

**Insulation Resistance** – Insulation Resistance is the resistance measured across the terminals of a capacitor and consists principally of the parallel resistance  $R_p$  shown in the equivalent circuit. As capacitance values and hence the area of dielectric increases, the I.R. decreases and hence the product ( $C \times IR$  or  $RC$ ) is often specified in ohm farads or more commonly megohm-microfarads. Leakage current is determined by dividing the rated voltage by IR (Ohm’s Law).

**Dielectric Strength** – Dielectric Strength is an expression of the ability of a material to withstand an electrical stress. Although dielectric strength is ordinarily expressed in volts, it is actually dependent on the thickness of the dielectric and thus is also more generically a function of volts/mil.

**Dielectric Absorption** – A capacitor does not discharge instantaneously upon application of a short circuit, but drains gradually after the capacitance proper has been discharged. It is common practice to measure the dielectric absorption by determining the “reappearing voltage” which appears across a capacitor at some point in time after it has been fully discharged under short circuit conditions.

**Corona** – Corona is the ionization of air or other vapors which causes them to conduct current. It is especially prevalent in high voltage units but can occur with low voltages as well where high voltage gradients occur. The energy discharged degrades the performance of the capacitor and can in time cause catastrophic failures.

### REFLOW SOLDERING

Case Size	D1	D2	D3	D4	D5
0201	0.85 (0.033)	0.30 (0.012)	0.25 (0.010)	0.30 (0.012)	0.35 (0.014)
0402	1.70 (0.067)	0.60 (0.024)	0.50 (0.020)	0.60 (0.024)	0.50 (0.020)
0603	2.30 (0.091)	0.80 (0.031)	0.70 (0.028)	0.80 (0.031)	0.75 (0.030)
0805	3.00 (0.118)	1.00 (0.039)	1.00 (0.039)	1.00 (0.039)	1.25 (0.049)
1206	4.00 (0.157)	1.00 (0.039)	2.00 (0.079)	1.00 (0.039)	1.60 (0.063)
1210	4.00 (0.157)	1.00 (0.039)	2.00 (0.079)	1.00 (0.039)	2.50 (0.098)
1808	5.60 (0.220)	1.00 (0.039)	3.60 (0.142)	1.00 (0.039)	2.00 (0.079)
1812	5.60 (0.220)	1.00 (0.039)	3.60 (0.142)	1.00 (0.039)	3.00 (0.118)
1825	5.60 (0.220)	1.00 (0.039)	3.60 (0.142)	1.00 (0.039)	6.35 (0.250)
2220	6.60 (0.260)	1.00 (0.039)	4.60 (0.181)	1.00 (0.039)	5.00 (0.197)
2225	6.60 (0.260)	1.00 (0.039)	4.60 (0.181)	1.00 (0.039)	6.35 (0.250)

Dimensions in millimeters (inches)

#### Component Pad Design

Component pads should be designed to achieve good solder files and minimize component movement during reflow soldering. Pad designs are given below for the most common sizes of multilayer ceramic capacitors for both wave and reflow soldering. The basis of these designs is:

- Pad width equal to component width. It is permissible to

decrease this to as low as 85% of component width but it is not advisable to go below this.

- Pad overlap 0.5mm beneath component.
- Pad extension 0.5mm beyond components for reflow and 1.0mm for wave soldering.

### WAVE SOLDERING

Case Size	D1	D2	D3	D4	D5
0603	3.10 (0.12)	1.20 (0.05)	0.70 (0.03)	1.20 (0.05)	0.75 (0.03)
0805	4.00 (0.15)	1.50 (0.06)	1.00 (0.04)	1.50 (0.06)	1.25 (0.05)
1206	5.00 (0.19)	1.50 (0.06)	2.00 (0.09)	1.50 (0.06)	1.60 (0.06)

Dimensions in millimeters (inches)

#### Component Spacing

For wave soldering components, must be spaced sufficiently far apart to avoid bridging or shadowing (inability of solder to penetrate properly into small spaces). This is less important for reflow soldering but sufficient space must be allowed to enable rework should it be required.

#### Preheat & Soldering

The rate of preheat should not exceed 4°C/second to prevent thermal shock. A better maximum figure is about 2°C/second.

For capacitors size 1206 and below, with a maximum thickness of 1.25mm, it is generally permissible to allow a temperature differential from preheat to soldering of 150°C. In all other cases this differential should not exceed 100°C.

For further specific application or process advice, please consult AVX.

#### Cleaning

Care should be taken to ensure that the capacitors are thoroughly cleaned of flux residues especially the space beneath the capacitor. Such residues may otherwise become conductive and effectively offer a low resistance bypass to the capacitor.

Ultrasonic cleaning is permissible, the recommended conditions being 8 Watts/litre at 20-45 kHz, with a process cycle of 2 minutes vapor rinse, 2 minutes immersion in the ultrasonic solvent bath and finally 2 minutes vapor rinse.



# Surface Mounting Guide

## Recommended Soldering Profiles



### REFLOW SOLDER PROFILES

AVX RoHS compliant products utilize termination finishes (e.g. Sn or SnAg) that are compatible with all Pb-Free soldering systems and are fully reverse compatible with SnPb soldering systems. A recommended SnPb profile is shown for comparison; for Pb-Free soldering, IPC/JEDECJ- STD-020C may be referenced. The upper line in the chart shows the maximum envelope to which products are qualified (typically 3x reflow cycles at 260°C max). The center line gives the recommended profile for optimum wettability and soldering in Pb-Free Systems.



#### Preheat:

The pre-heat stabilizes the part and reduces the temperature differential prior to reflow. The initial ramp to 125°C may be rapid, but from that point (2-3)°C/sec is recommended to allow ceramic parts to heat uniformly and plastic encapsulated parts to stabilize through the glass transition temperature of the body (~ 180°C).

#### Reflow:

In the reflow phase, the maximum recommended time > 230°C is 40secs. Time at peak reflow is 10secs max.; optimum reflow is achieved at 250°C, (see wetting balance chart opposite) but products are qualified to 260°C max. Please reference individual product datasheets for maximum limits

#### Cool Down:

Cool down should not be forced and 6°C/sec is recommended. A slow cool down will result in a finer grain structure of the reflow solder in the solder fillet.

### WAVE SOLDER PROFILES

For wave solder, there is no change in the recommended wave profile; all standard Pb-Free (SnCu/SnCuAg) systems operate at the same 260°C max recommended for SnPb systems.

#### Preheat:

This is more important for wave solder; a higher temperature preheat will reduce the thermal shock to SMD parts that are immersed (please consult individual product data sheets for SMD parts that are suited to wave solder). SMD parts should ideally be heated from the bottom-Side prior to wave. PTH (Pin through hole) parts on the topside should not be separately heated.

#### Wave:

250°C – 260°C recommended for optimum solderability.

#### Cool Down:

As with reflow solder, cool down should not be forced and 6°C/sec is recommended. Any air knives at the end of the 2nd wave should be heated.

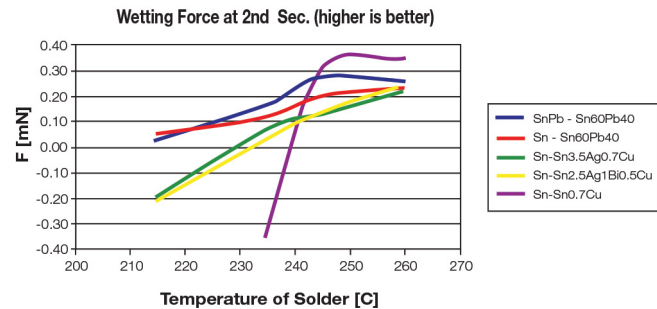

**IMPORTANT NOTE:** Typical Pb-Free reflow solders have a more dull and grainy appearance compared to traditional SnPb. Elevating the reflow temperature will not change this, but extending the cool down can help improve the visual appearance of the joint.

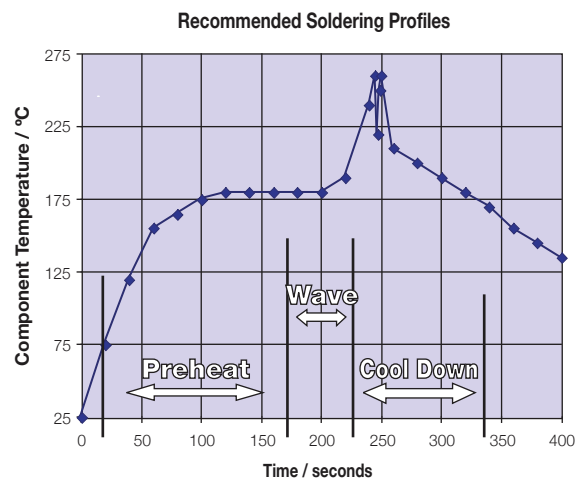

### APPLICATION NOTES

#### Storage

The components should be stored in their “as received packaging” where possible. If the components are removed from their original packaging then they should be stored in an airtight container (e.g. a heat sealed plastic bag) with desiccant (e.g. silica gel). Storage area temperature should be kept between +5 degrees C and +30 degrees C with humidity < 70% RH. Storage atmosphere must be free of gas containing sulfur and chlorine. Avoid exposing the product to saline moisture or to temperature changes that might result in the formation of condensation. To assure good solderability performance we recommend that the product be used within 6 months from our shipping date, but can be used for up to 12 months. Chip capacitors may crack if exposed to hydrogen (H<sub>2</sub>) gas while sealed or if coated with silicon, which generates hydrogen gas.

#### Solderability

Terminations to be well soldered after immersion in a 60/40 tin/lead solder bath at 245°C +/- 5°C for 5 +0/-0.5 seconds.

#### Leaching

Terminations will resist leaching for at least the immersion times and conditions shown below.

Termination Type	Solder Tin/ Lead/Silver	Solder Temp °C	Immersion Time Seconds
Nickel Barrier	60/40/0	260 ± 5	30 ± 1

#### Lead-Free Wave Soldering

The recommended peak temperature for lead-free wave soldering is 250°C-260°C for 3-5 seconds. The other parameters of the profile remains the same as above.

The following should be noted by customers changing from lead based systems to the new lead free pastes.

- A. The visual standards used for evaluation of solder joints will need to be modified as lead free joints are not as bright as with tin-lead pastes and the fillet may not be as large.
- B. Lead-free solder pastes do not allow the same self alignment as lead containing systems. Standard mounting pads are acceptable, but machine set up may need to be modified.

#### General

Surface mounting chip multilayer ceramic capacitors are designed for soldering to printed circuit boards or other substrates. The construction of the components is such that they will withstand the time/temperature profiles used in both wave and reflow soldering methods.

#### Handling

Chip multilayer ceramic capacitors should be handled with care to avoid damage or contamination from perspiration and skin oils. The use of tweezers or vacuum pick ups is strongly recommended for individual components. Bulk handling should ensure that abrasion and mechanical shock are minimized. Taped and reeled components provides the ideal medium for direct presentation to the placement machine. Any mechanical shock should be minimized during handling chip multilayer ceramic capacitors.

#### Preheat

It is important to avoid the possibility of thermal shock during soldering and carefully controlled preheat is therefore required. The rate of preheat should not exceed 4°C/second and a target figure 2°C/second is recommended. Although an 80°C to 120°C temperature differential is preferred, recent developments allow a temperature differential between the component surface and the soldering temperature of 150°C (Maximum) for capacitors of 1210 size and below with a maximum thickness of 1.25mm. The user is cautioned that the risk of thermal shock increases as chip size or temperature differential increases.

#### Soldering

Mildly activated rosin fluxes are preferred. The minimum amount of solder to give a good joint should be used. Excessive solder can lead to damage from the stresses caused by the difference in coefficients of expansion between solder, chip and substrate. AVX terminations are suitable for all wave and reflow soldering systems. If hand soldering cannot be avoided, the preferred technique is the utilization of hot air soldering tools.

#### Cooling

Natural cooling in air is preferred, as this minimizes stresses within the soldered joint. When forced air cooling is used, cooling rate should not exceed 4°C/second. Quenching is not recommended but if used, maximum temperature differentials should be observed according to the preheat conditions above.

#### Cleaning

Flux residues may be hygroscopic or acidic and must be removed. AVX MLC capacitors are acceptable for use with all of the solvents described in the specifications MIL-STD-202 and EIA-RS-198. Alcohol based solvents are acceptable and properly controlled water cleaning systems are also acceptable. Many other solvents have been proven successful, and most solvents that are acceptable to other components on circuit assemblies are equally acceptable for use with ceramic capacitors.

#### Prevention of Metallic Migration

Note that when components with Sn plating on the end terminations are to be used in applications that are likely to experience conditions of high humidity under bias voltage, we strongly recommend that the circuit boards be conformally coated to protect the Sn from moisture that might lead to migration and eventual current leakage.

When using Capacitor Arrays we recommend that there is no differential in applied voltage between adjacent elements.

# Surface Mounting Guide



## MLC Chip Capacitors

### POST SOLDER HANDLING

Once SMP components are soldered to the board, any bending or flexure of the PCB applies stresses to the soldered joints of the components. For leaded devices, the stresses are absorbed by the compliancy of the metal leads and generally don't result in problems unless the stress is large enough to fracture the soldered connection.

Ceramic capacitors are more susceptible to such stress because they don't have compliant leads and are brittle in nature. The most frequent failure mode is low DC resistance or short circuit. The second failure mode is significant loss of capacitance due to severing of contact between sets of the internal electrodes.

Cracks caused by mechanical flexure are very easily identified and generally take one of the following two general forms:

Mechanical cracks are often hidden underneath the termination and are difficult to see externally. However, if one end termination falls off during the removal process from PCB, this is one indication that the cause of failure was excessive mechanical stress due to board warping.

### COMMON CAUSES OF MECHANICAL CRACKING

The most common source for mechanical stress is board depanelization equipment, such as manual breakapart, v-cutters and shear presses. Improperly aligned or dull cutters may cause torqueing of the PCB resulting in flex stresses being transmitted to components near the board edge. Another common source of flexural stress is contact during parametric testing when test points are probed. If the PCB is allowed to flex during the test cycle, nearby ceramic capacitors may be broken.

A third common source is board to board connections at vertical connectors where cables or other PCBs are connected to the PCB. If the board is not supported during the plug/unplug cycle, it may flex and cause damage to nearby components.

Special care should also be taken when handling large (>6" on a side) PCBs since they more easily flex or warp than smaller boards.

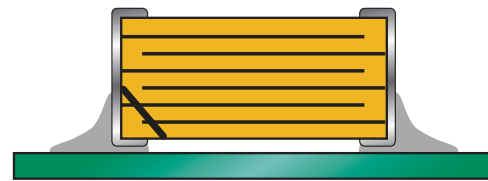

Type A:  
Angled crack between bottom of device to top of solder joint.

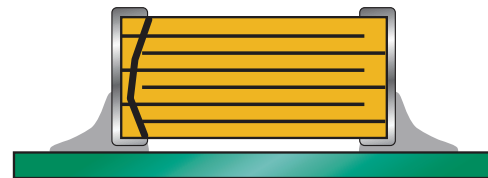

Type B:  
Fracture from top of device to bottom of device.

### REWORKING OF MLCs

Thermal shock is common in MLCs that are manually attached or reworked with a soldering iron. AVX strongly recommends that any reworking of MLCs be done with hot air reflow rather than soldering irons. It is practically impossible to cause any thermal shock in ceramic capacitors when using hot air reflow.

However direct contact by the soldering iron tip often causes thermal cracks that may fail at a later date. If rework by soldering iron is absolutely necessary, it is recommended that the wattage of the iron be less than 30 watts and the tip temperature be <300°C. *Rework should be performed by applying the solder iron tip to the pad and not directly contacting any part of the ceramic capacitor.*

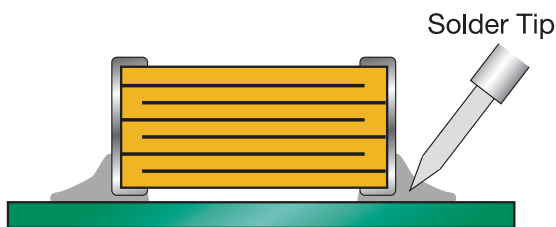

Preferred Method - No Direct Part Contact

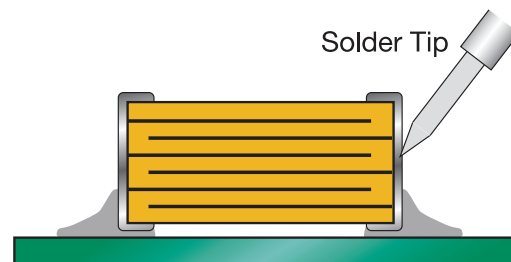

Poor Method - Direct Contact with Part

### PCB BOARD DESIGN

To avoid many of the handling problems, AVX recommends that MLCs be located at least .2" away from nearest edge of board. However when this is not possible, AVX recommends that the panel be routed along the cut line, adjacent to where the MLC is located.



No Stress Relief for MLCs

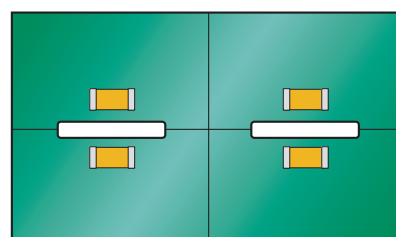

Routed Cut Line Relieves Stress on MLC

**FOLLOW US:**     

VISIT US AT [WWW.AVX.COM](http://WWW.AVX.COM) 



**North America**

Tel: +1 864-967-2150

**Europe**

Tel: +44 1276-697000

**Asia**

Tel: +65 6286-7555

**Central America**

Tel: +55 11-46881960

**Japan**

Tel: +81 740-321250

## Looking for pricing, stock, or lifecycle information?

Click below to explore more details on WIN SOURCE:

 [View 1808HA330KAT1A on WIN SOURCE](#)

 [AVX Corporation Information](#)

## Optimize Your Supply Chain with WIN SOURCE Solutions

-  Global Sourcing Solution
-  Obsolete Management
-  Cost Control Management
-  Shortage Management
-  Alternative Solution
-  Excess Inventory Management