

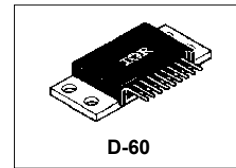

**THE DATASHEET OF
151CMQ035**





Major Ratings and Characteristics

Characteristics	151CMQ...	Units
$I_{F(AV)}$ Rectangular waveform	150	A
V_{RRM} range	35 to 50	V
I_{FSM} @tp=5 μ s sine	9200	A
V_F @75Apk, $T_J=125^\circ\text{C}$ (per leg)	0.65	V
T_J range	-55 to 175	$^\circ\text{C}$

Description/ Features

The 151CMQ isolated center tap Schottky rectifier module series has been optimized for low reverse leakage at high temperature. The proprietary barrier technology allows for reliable operation up to 175 $^\circ\text{C}$ junction temperature. Typical applications are in switching power supplies, converters, free-wheeling diodes, and reverse battery protection.

- 175 $^\circ\text{C}$ T_J operation
- Isolated heatsink
- Center tap module
- Multiple leads per terminal for high frequency, high current PC board mounting
- High purity, high temperature epoxy encapsulation for enhanced mechanical strength and moisture resistance
- Low forward voltage drop
- High frequency operation
- Guard ring for enhanced ruggedness and long term reliability
- Low profile, high current package

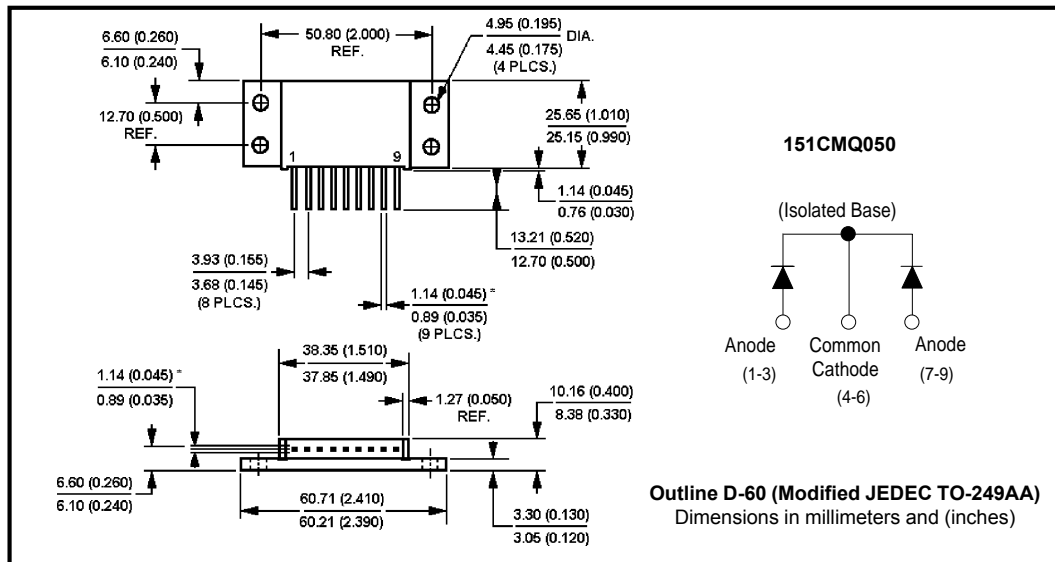

151CMQ... Series

Bulletin PD-2.252 rev. B 05/02

International
IR Rectifier

Voltage Ratings

Part number	151CMQ035	151CMQ040	151CMQ045	151CMQ050
V_R Max. DC Reverse Voltage (V)	35	40	45	50
V_{RWM} Max. Working Peak Reverse Voltage (V)				

Absolute Maximum Ratings

Parameters	151CMQ	Units	Conditions
$I_{F(AV)}$ Max. Average Forward Current * See Fig. 5	150	A	50% duty cycle @ $T_C = 104^\circ\text{C}$, rectangular wave form
I_{FSM} Max. Peak One Cycle Non-Repetitive Surge Current (Per Leg) * See Fig. 7	9200	A	Following any rated load condition and with rated V_{RWM} applied
	1200		
E_{AS} Non-Repetitive Avalanche Energy (Per Leg)	101	mJ	$T_J = 25^\circ\text{C}$, $I_{AS} = 15\text{Amps}$, $L = 0.9\text{mH}$
I_{AR} Repetitive Avalanche Current (Per Leg)	15	A	Current decaying linearly to zero in 1 μsec Frequency limited by T_J max. $V_A = 1.5 \times V_R$ typical

Electrical Specifications

Parameters	151CMQ	Units	Conditions
V_{FM} Max. Forward Voltage Drop (Per Leg) * See Fig. 1 (1)	0.71	V	@ 75A
	0.92	V	@ 150A
	0.65	V	@ 75A
	0.82	V	@ 150A
I_{RM} Max. Reverse Leakage Current (Per Leg) * See Fig. 2 (1)	5	mA	$T_J = 25^\circ\text{C}$
	45	mA	$T_J = 125^\circ\text{C}$
C_T Max. Junction Capacitance (Per Leg)	2600	pF	$V_R = 5V_{DC}$ (test signal range 100Khz to 1Mhz) 25°C
L_S Typical Series Inductance (Per Leg)	9.2	nH	Measured lead to lead 5mm from package body
dv/dt Max. Voltage Rate of Change (Rated V_R)	10000	V/ μs	

(1) Pulse Width < 300 μs , Duty Cycle <2%

Thermal-Mechanical Specifications

Parameters	151CMQ	Units	Conditions
T_J Max. Junction Temperature Range	-55 to 175	$^\circ\text{C}$	
T_{stg} Max. Storage Temperature Range	-55 to 175	$^\circ\text{C}$	
R_{thJC} Max. Thermal Resistance Junction to Case (Per Leg)	1.0	$^\circ\text{C/W}$	DC operation * See Fig. 4
R_{thJC} Max. Thermal Resistance Junction to Case (Per Package)	0.50	$^\circ\text{C/W}$	DC operation
R_{thCS} Typical Thermal Resistance, Case to Heatsink	0.10	$^\circ\text{C/W}$	Mounting surface, smooth and greased
wt Approximate Weight	56 (2.0)	g (oz.)	
T Mounting Torque	Min.	40 (35)	Kg-cm (lbf-in)
	Max.	58 (50)	
Case Style	D-60 (TO-249AA)		Modified JEDEC

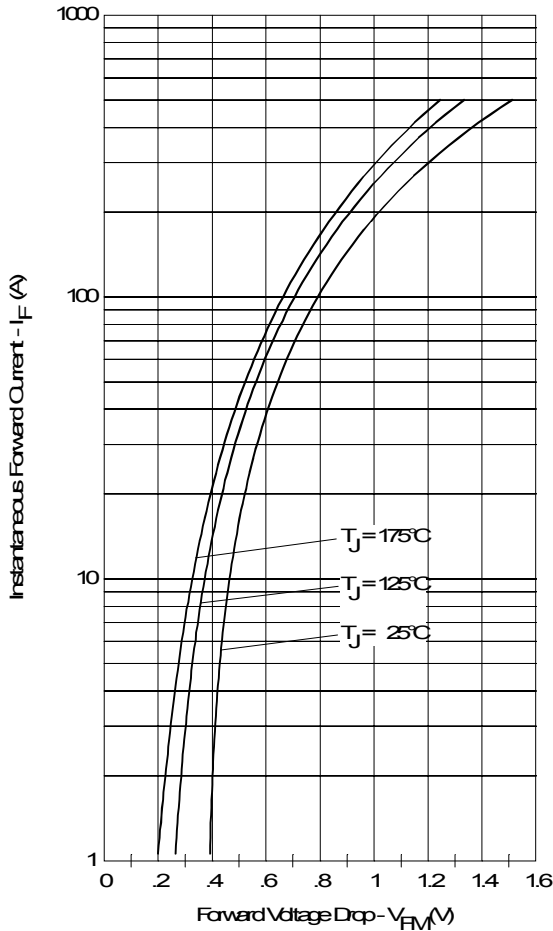

Fig. 1 - Max. Forward Voltage Drop Characteristics (Per Leg)

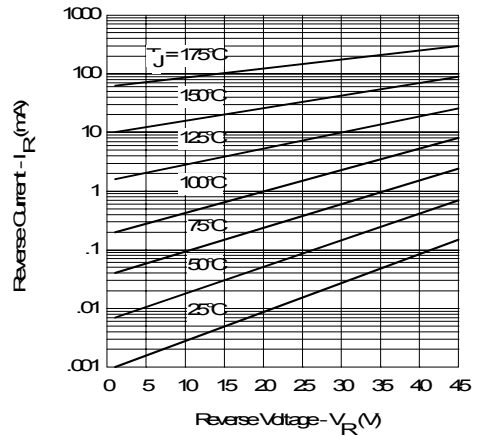

Fig. 2 - Typical Values Of Reverse Current Vs. Reverse Voltage (Per Leg)

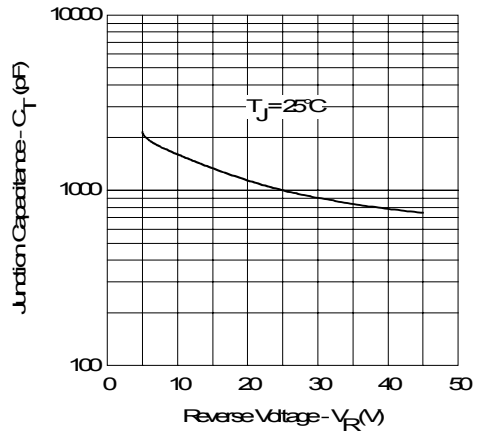

Fig. 3 - Typical Junction Capacitance Vs. Reverse Voltage (Per Leg)

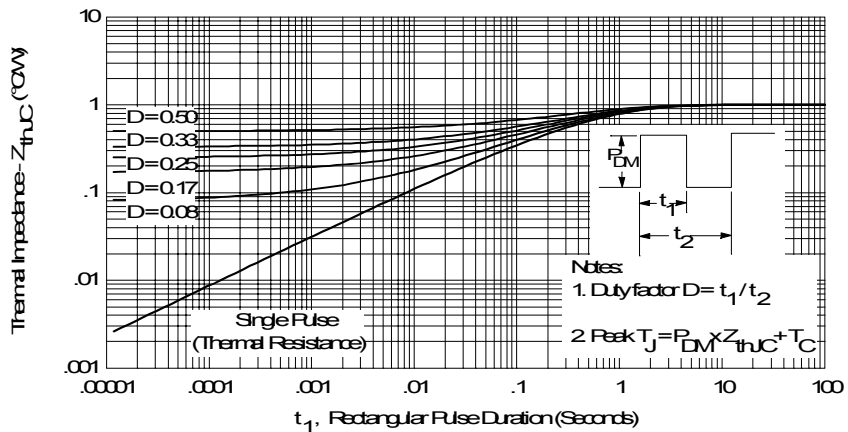

Fig. 4 - Max. Thermal Impedance Z_{thJC} Characteristics (Per Leg)

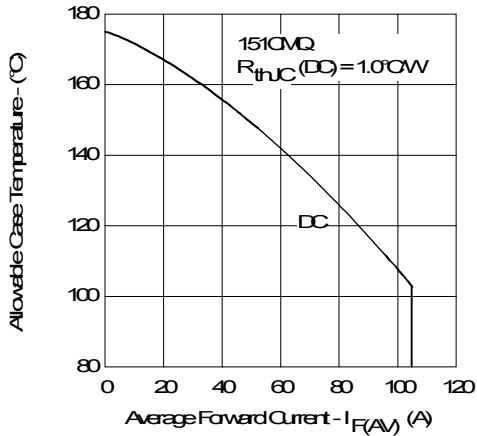

Fig. 5- Max. Allowable Case Temperature Vs. Average Forward Current (Per Leg)

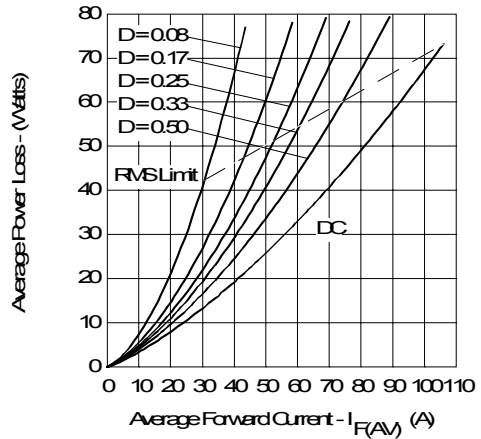

Fig. 6- Forward Power Loss Characteristics (Per Leg)

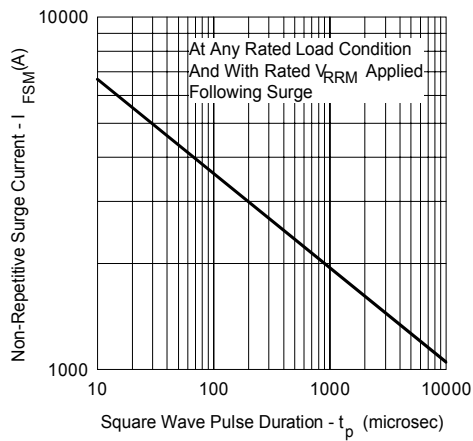

Fig. 7- Max. Non-Repetitive Surge Current (Per Leg)

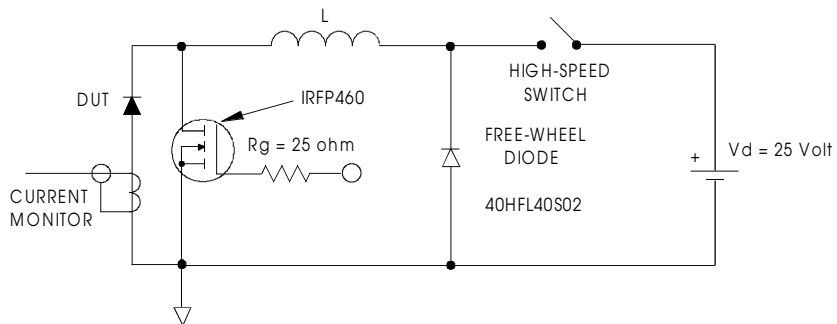

Fig. 8- Unclamped Inductive Test Circuit

Data and specifications subject to change without notice.
This product has been designed and qualified for Industrial Level.
Qualification Standards can be found on IR's Web site.

International
IOR Rectifier

IR WORLD HEADQUARTERS: 233 Kansas St., El Segundo, California 90245, USA Tel: (310) 252-7105
TAC Fax: (310) 252-7309
Visit us at www.irf.com for sales contact information. 05/02

Looking for pricing, stock, or lifecycle information?

Click below to explore more details on WIN SOURCE:

[View 151CMQ035 on WIN SOURCE](#)

[Vishay Information](#)

Optimize Your Supply Chain with WIN SOURCE Solutions

- ✓ Global Sourcing Solution
- ✓ Obsolete Management
- ✓ Cost Control Management
- ✓ Shortage Management
- ✓ Alternative Solution
- ✓ Excess Inventory Management