



**THE DATASHEET OF
0402SFF200F/24-2**



Surface-Mount Fuses Fundamentals

Overview

TE Circuit Protection offers the widest selection of surface-mount fuses available for addressing a broad range of overcurrent protection applications. Helping to prevent costly damage and promote a safe environment for electronic and electrical equipment, our single-use chip fuses provide performance stability to support applications with current ratings from .5A up to 20A.

TE Circuit Protection also offers the telecom FT600 fuse for telecommunications applications. This telecom fuse helps comply with North American overcurrent protection requirements, including Telcordia, GR-1089, TIA-968-A (formerly FCC Part 68), and UL60950 3rd edition.



Multi-layer Design for Chip Fuses

The multi-layer design has the benefit of exposing more fuse element surface area to the glass-ceramic absorption material. When the fuse elements open, there is more material for the vaporizing fuse metals to absorb into, resulting in a very efficient and effective quenching of the fuse arc.

Figure SF1 compares the multi-layer design of our SFF fuses with standard glass coated designs. The glass coated designs rely on the coating on only one side of the fuse element to absorb the vaporizing fuse material when it opens. Therefore, there is much less absorption material available to absorb the fuse metals. The result can be prolonged arcing and possible coating breach.

Figure SF2 shows how the absorption characteristics of the two designs differ. The multi-layer design indicates a clean separation with the fuse element evenly diffusing into the surrounding ceramic substrate. In the glass coated design, the element diffusion takes place in a small portion of the device and is only absorbed by the glass material directly above the area of failure.

Figure SF1

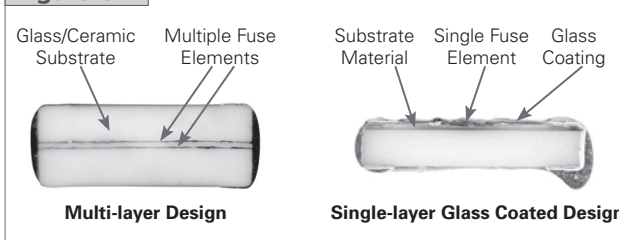
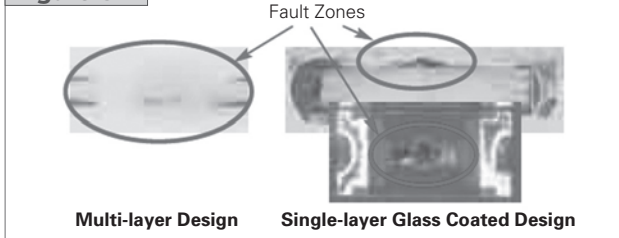

Figure SF2



Wire-In-Air Design for 2410SFV Fuses

The 2410(6125) is a Wire-In-Air SMD fuse that is suitable for secondary level overcurrent protection applications.

Figure SF3 compares our straight wire element design 2410SFV fuses with normal corrugated wire design fuse. The straight wire element in air provides consistent fusing and cutting characteristics together with inrush current withstanding capability.

By introducing PCB assembly technology into the 2410SFV fuse design and manufacturing process, lead-free compliance has been achieved without the problems associated with end caps on traditional ceramic devices.

Figure SF3

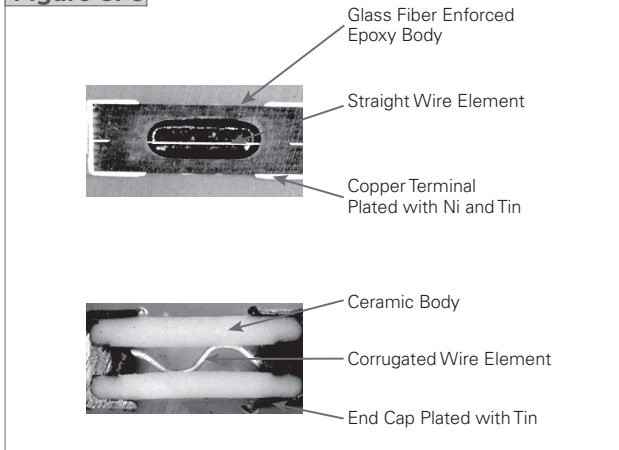

Temperature Derating

A fuse is a temperature sensitive device. Therefore, operating temperature will have an effect on fuse performance and lifetime. Operating temperature should be taken into consideration when selecting the fuse current rating. The Thermal Derating Curve for surface-mount fuses is presented in Figure SF4. Use it to determine the derating percentage based on operating temperature and apply it to the derated system current.



Pulse Cycle Derating

Once the I^2t value for the application waveform has been determined, it must be derated based on the number of cycles expected over the system lifetime. Since the stress induced by the current pulse is mechanical in nature, the number of times the stress is applied has significant bearing on how much derating must be applied to the fuse rating. Figure SF5 presents the current pulse derating curve for our surface-mount chip fuses up to 100,000 cycles.

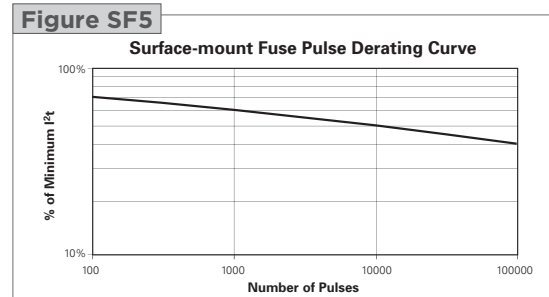

Selecting Surface-mount Fuses

Fuse selection seems straightforward, in that you pick one which has a current rating just a bit higher than your worst case system operating current. Unfortunately, it is not that simple. There are derating considerations for operating current and application temperature. Turn-on and other system operations (like processor speed changes or motor start up) cause current surges or spikes that also require consideration when selecting a fuse. So selecting the right fuse for your application is not as simple as knowing the nominal current drawn by the system.

Fuse Selection Flowchart

However, the basic considerations for fuse selection are shown in the flow chart presented in Figure SF6. Following this flow chart will help you select a fuse best suited for your application conditions. For a detailed example of this process you can download our Fuse Selection Guide available on our website.

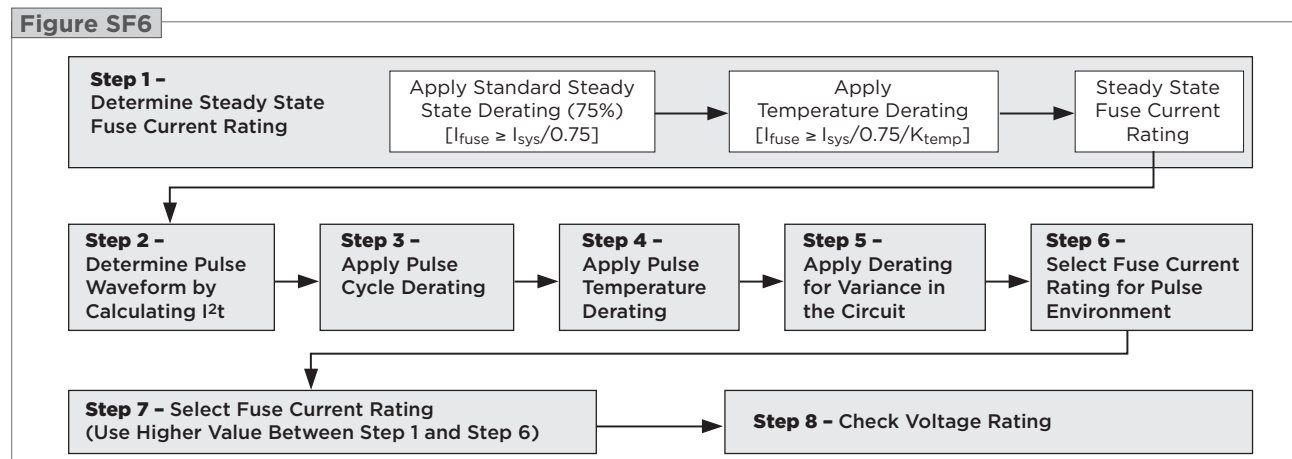



Surface-Mount Fuses

Pulse Tolerant Chip Fuses



Pulse Tolerant Chip Fuses have high inrush current withstand capability and provide overcurrent protection for DC power systems. These devices combine a silver fusing element and monolithic, multilayer design to provide strong arc suppression characteristics.

These RoHS-compliant surface-mount devices can help facilitate the development of more reliable, high-performance consumer electronics such as laptops, multimedia devices, cell phones and other portable electronics.



Benefits

- High inrush current withstand capability
- Ceramic monolithic structure
- Silver fusing element and silver termination with nickel and tin plating
- Temperature stability
- Strong arc suppression characteristics

Features

- Lead free materials and RoHS compliant
- Halogen free
(refers to: Br≤900ppm, Cl≤900ppm, Br+Cl≤1500ppm)
- Monolithic, multilayer design
- High-temperature performance
- -55°C to +125°C operating temperature range

Applications

- | | | |
|-------------------|------------------------|----------------|
| • Laptops | • Printers | • Game systems |
| • Digital cameras | • DVD players | • LCD monitors |
| • Cell phones | • Portable electronics | • Scanners |

10

Table FP1 Clear Time Characteristics for Pulse Tolerant Chip Fuses

% of rated current	Clear time at 25°C	
100%	4 hrs (min)	
200%	1 s (min)	60 s (max)
1000%	0.0002 s (min)	0.02 s (max)

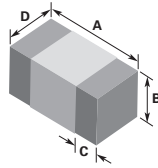
Table FP2 Typical Electrical Characteristics and Dimensions for Pulse Tolerant Chip Fuses
0603 (1608 mm) Pulse Tolerant Chip Fuses
Shape and Dimensions
mm (in)

	A		B		C		D	
	Min	Max	Min	Max	Min	Max	Min	Max
mm	1.45	1.75	0.65	0.95	0.21	0.51	0.65	0.95
in	(0.057)	(0.069)	(0.026)	(0.037)	(0.008)	(0.020)	(0.026)	(0.037)

Part Number	Typical Electrical Characteristics			Max Interrupt Ratings	
	Rated Current (A)	Nominal Cold DCR (Ω)*	Nominal I ² t (A ² s)†	Voltage (V _{DC})	Current (A)
0603SFP100F/32-2	1.0	0.210	0.08	32	50
0603SFP150F/32-2	1.5	0.101	0.11	32	50
0603SFP200F/32-2	2.0	0.057	0.24	32	50
0603SFP250F/32-2	2.5	0.042	0.56	32	50
0603SFP300F/32-2	3.0	0.030	0.72	32	50
0603SFP350F/32-2	3.5	0.022	1.10	32	50
0603SFP400F/32-2	4.0	0.018	2.08	32	50
0603SFP450F/32-2	4.5	0.014	2.63	32	50
0603SFP500F/32-2	5.0	0.013	3.25	32	50
0603SFP600F/32-2	6.0	0.010	4.00	32	70

1206 (3216 mm) Pulse Tolerant Chip Fuses

10

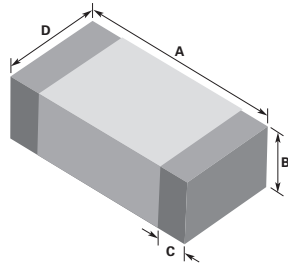
Shape and Dimensions
mm (in)

	A		B		C		D	
	Min	Max	Min	Max	Min	Max	Min	Max
mm	3.00	3.40	0.77	1.17	0.26	0.76	1.40	1.80
in	(0.118)	(0.134)	(0.030)	(0.046)	(0.010)	(0.030)	(0.055)	(0.071)

Part Number	Typical Electrical Characteristics			Max Interrupt Ratings	
	Rated Current (A)	Nominal Cold DCR (Ω)*	Nominal I ² t (A ² sec)†	Voltage (V _{DC})	Current (A)
1206SFP100F/63-2	1.0	0.340	0.11	63	50
1206SFP150F/63-2	1.5	0.150	0.33	63	50
1206SFP200F/63-2	2.0	0.090	0.80	63	50
1206SFP250F/32-2	2.5	0.070	1.19	32	50
1206SFP300F/32-2	3.0	0.035	1.35	32	50
1206SFP350F/32-2	3.5	0.029	1.84	32	50
1206SFP400F/32-2	4.0	0.023	2.74	32	50
1206SFP450F/32-2	4.5	0.021	3.20	32	50
1206SFP500F/32-2	5.0	0.017	5.50	32	50
1206SFP600F/24-2	6.0	0.013	12.50	24	80
1206SFP700F/24-2	7.0	0.010	30.00	24	80
1206SFP800F/24-2	8.0	0.009	60.00	24	80

* Measured at ≤10% of rated current and 25°C ambient temperature.
† Melting I²t at 0.001 sec clear time.

Figures FP1-FP4 Family Performance Curves for Pulse Tolerant Chip Fuses

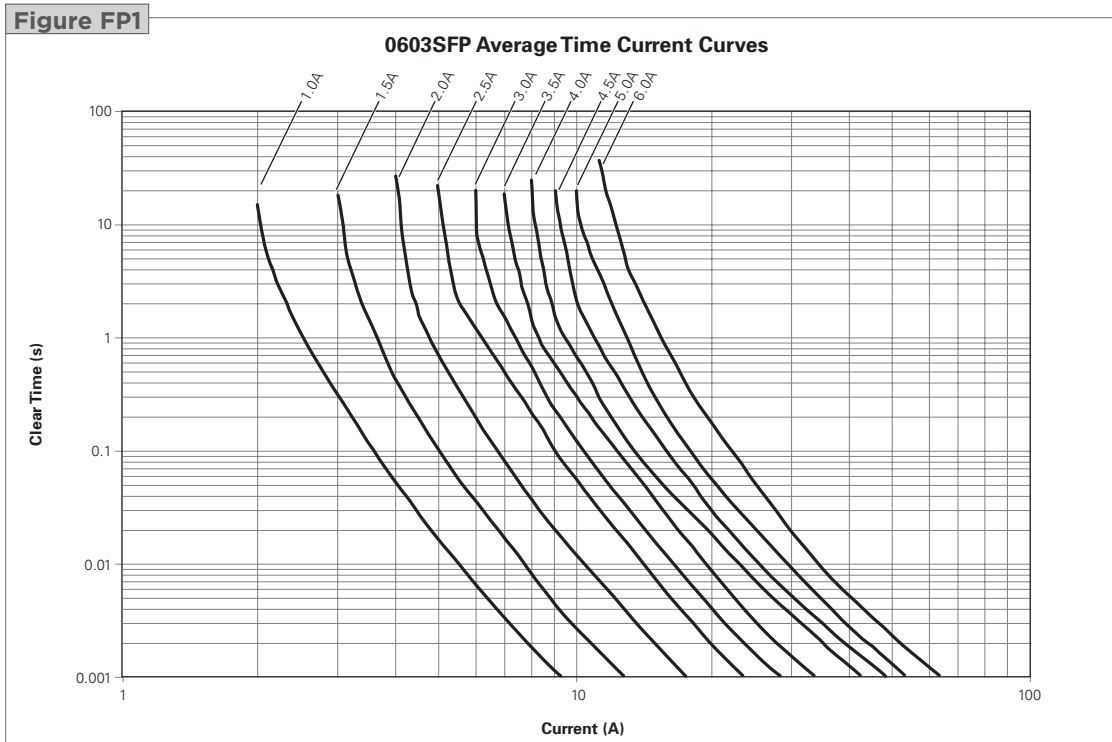

Note: Curves are nominal.

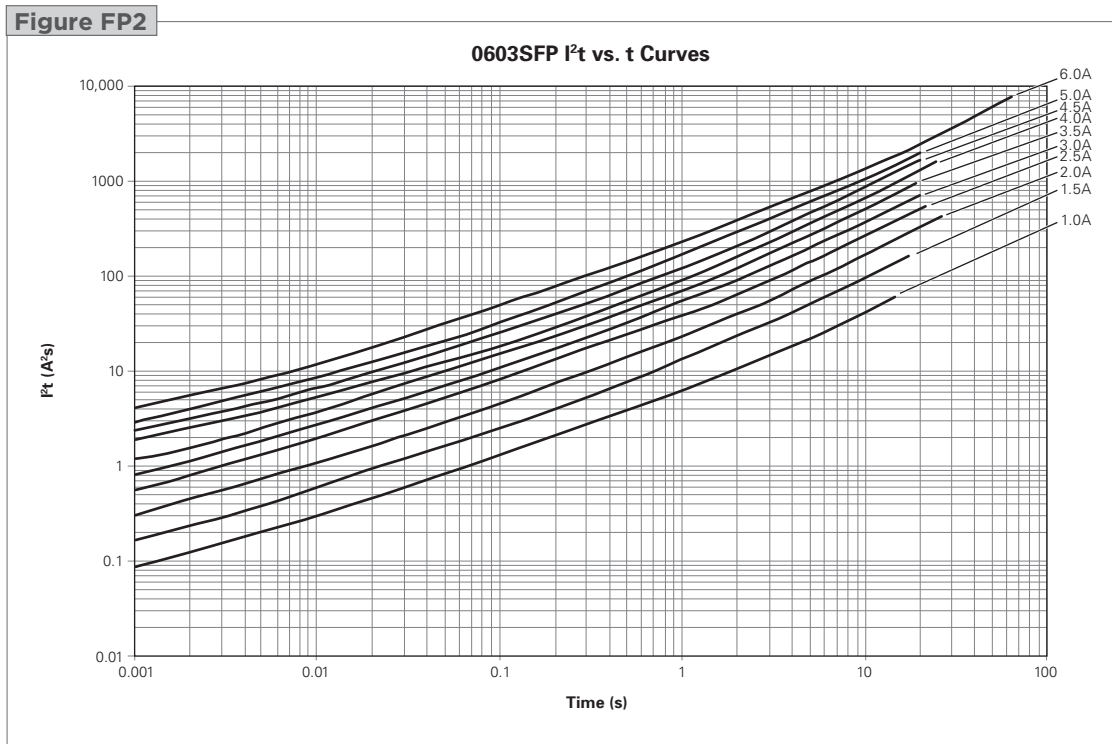



Note: Curves are nominal.

→ Please go to page 129 for more information about Pulse Tolerant Chip Fuses.



Surface-Mount Fuses

0603 Very Fast-Acting Chip Fuses



Very fast-acting chip fuses help provide overcurrent protection for systems using DC power sources up to 32V_{DC}. The fuse's monolithic, multilayer design helps provide the highest hold current in the smallest footprint, reduce diffusion-related aging, improve product reliability and resilience, and enhance high-temperature performance in a wide range of circuit designs.

These RoHS-compliant surface-mount devices offer strong arc suppression characteristics and facilitate the development of more reliable, high-performance consumer electronics such as laptops, multimedia devices, cell phones and other portable electronics.



Benefits

- Very fast acting at 200% and 300% overloads
- Inrush current withstand capability at high overloads
- Thin body for space-limited applications
- Glass ceramic monolithic structure
- Silver fusing element and silver termination with nickel and tin plating
- RoHS compliant and lead-free materials
- Symmetrical design with marking on both sides (optional)

Features

- Lead-free materials and RoHS compliant
- Halogen free
(refers to: Br≤900ppm, Cl≤900ppm, Br+Cl≤1500ppm)
- Monolithic, multilayer design
- High-temperature performance
- -55°C to +125°C operating temperature range

Applications

- | | | |
|-------------------|------------------------|----------------|
| • Laptops | • Printers | • Game systems |
| • Digital cameras | • DVD players | • LCD monitors |
| • Cell phones | • Portable electronics | • Scanners |

Table FV1 Clear Time Characteristics for Very Fast-Acting Chip Fuses

% of Rated Current	Clear Time at 25°C	
100%	4 hrs (min)	
200%	0.01 s (min)	5 s (max)
300%	0.001 s (min)	0.2 s (max)

Table FV2 Typical Electrical Characteristics and Dimensions for Very Fast-Acting Chip Fuses

0603 (1608mm) Very Fast-Acting Chip Fuses

Shape and Dimensions
mm (in)

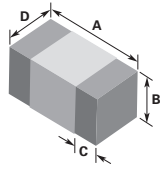

	A		B		C		D	
	Min	Max	Min	Max	Min	Max	Min	Max
mm	1.45	1.75	0.22	0.48	0.21	0.51	0.65	0.95
in	(0.057)	(0.069)	(0.009)	(0.019)	(0.008)	(0.020)	(0.025)	(0.037)

Part Number	Typical Electrical Characteristics			Max Interrupt Ratings	
	Rated Current (A)	Nominal Cold DCR (Ω)*	Nominal I ² t (A ² s)	Voltage (V _{DC})	Current (A)
0603SFV050F/32-2	0.5	0.860	0.0093	32	50
0603SFV075F/32-2	0.8	0.450	0.0191	32	50
0603SFV100F/32-2	1.0	0.280	0.0360	32	50
0603SFV125F/32-2	1.3	0.205	0.0630	32	35
0603SFV150F/32-2	1.5	0.143	0.0950	32	35
0603SFV175F/32-2	1.8	0.095	0.1400	32	35
0603SFV200F/32-2	2.0	0.073	0.2100	32	35
0603SFV250F/32-2	2.5	0.046	0.3000	32	35
0603SFV300F/32-2	3.0	0.039	0.4600	32	35
0603SFV350F/32-2	3.5	0.028	0.7300	32	35
0603SFV400F/32-2	4.0	0.023	1.1500	32	35
0603SFV450F/32-2	4.5	0.019	1.6800	32	35
0603SFV500F/32-2	5.0	0.015	2.6200	32	35

* Measured at 10% of rated current and 25°C.

Figures FV1-FV2 Family Performance Curves for Very Fast-Acting Chip Fuses

Figure FV1

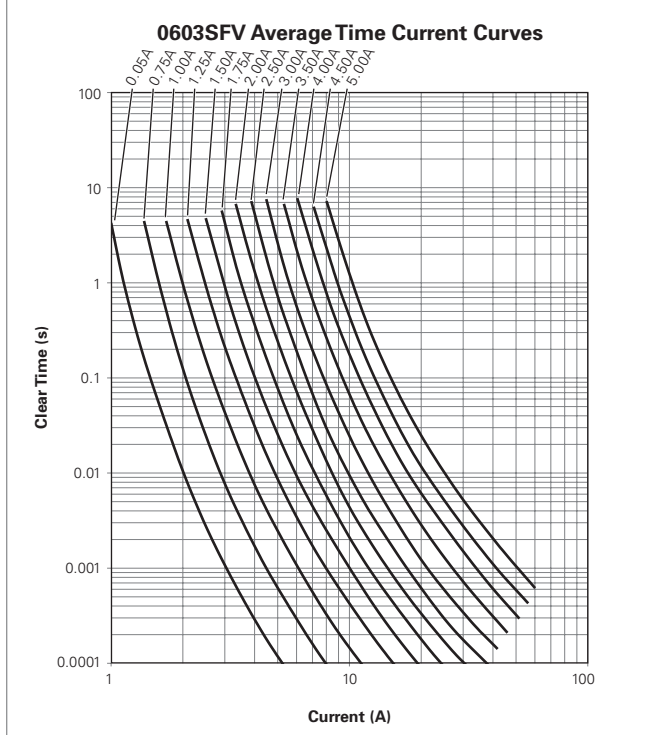
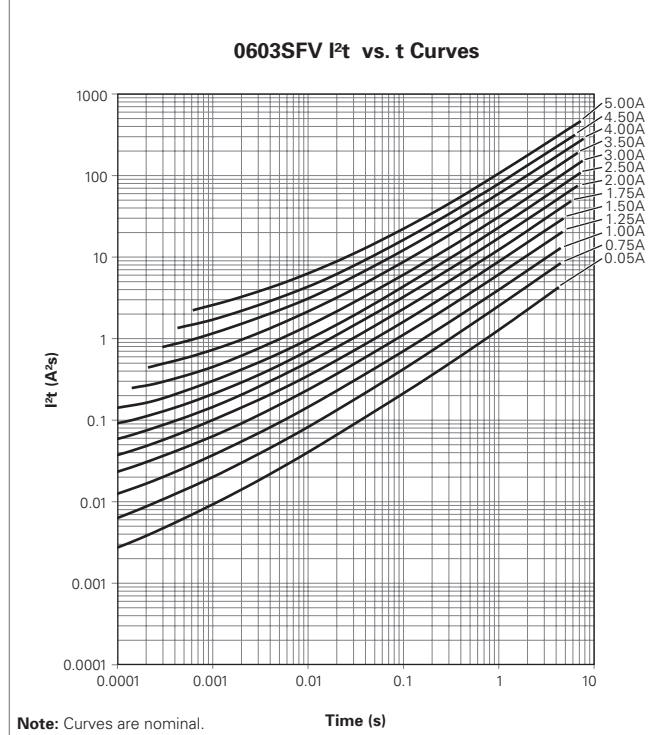

Figure FV2



Note: Curves are nominal.

→ Please go to page 129 for more information about Very Fast-Acting Chip Fuses.



Surface-Mount Fuses

Fast-Acting Chip Fuses

Fast-acting chip fuses help provide overcurrent protection for systems using DC power sources up to 63V_{DC}. The fuse's monolithic, multilayer design helps provide the highest hold current in the smallest footprint, reduce diffusion-related aging, improve product reliability and resilience, and enhance high-temperature performance in a wide range of circuit designs.

These RoHS-compliant surface-mount devices offer strong arc suppression characteristics and help facilitate the development of more reliable, high-performance consumer electronics such as laptops, multimedia devices, cell phones and other portable electronics.



Benefits

- Small size with high-current ratings
- Temperature stability
- High reliability and resilience
- Strong arc suppression characteristics

Features

- Lead-free and RoHS compliant
- Halogen free
(refers to: Br≤900ppm, Cl≤900ppm, Br+Cl≤1500ppm)
- Monolithic, multilayer design
- High-temperature performance
- -55°C to +125°C operating temperature range

Applications

- | | | |
|-------------------|------------------------|----------------|
| • Laptops | • Printers | • Game systems |
| • Digital cameras | • DVD players | • LCD monitors |
| • Cell phones | • Portable electronics | • Scanners |

Table FF1 Clear Time Characteristics for Fast-Acting Chip Fuses

% of Rated Current	Clear Time at 25°C
100%	4 hrs min
250%	5 s max
400%	0.05 s max

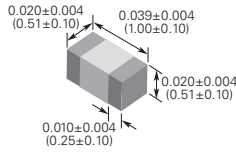
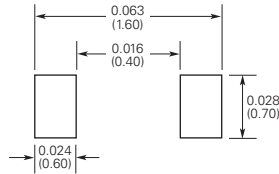
Table FF2 Typical Electrical Characteristics, Dimensions and Recommended Pad Layout for Fast-Acting Chip Fuses
0402 (1005mm) Fast-Acting Chip Fuses
Shape and Dimensions
in (mm)

Recommended Pad Layout
in (mm)

Typical Electrical Characteristics
Max Interrupt Ratings

Part Number	Typical Electrical Characteristics			Max Interrupt Ratings	
	Rated Current (A)	Nominal Cold DCR (Ω)*	Nominal I ² t (A ² s)†	Voltage (V _{DC})	Current (A)
0402SFF100F/24	1.00	0.120	0.0170	24	35
0402SFF150F/24	1.50	0.056	0.0490	24	35
0402SFF200F/24	2.00	0.035	0.0700	24	35
0402SFF300F/24	3.00	0.021	0.1250	24	35
0402SFF400F/24	4.00	0.014	0.2250	24	35

0603 (1608mm) Fast-Acting Chip Fuses
Shape and Dimensions
in (mm)

Recommended Pad Layout
in (mm)

Typical Electrical Characteristics
Max Interrupt Ratings

Part Number	Typical Electrical Characteristics			Max Interrupt Ratings	
	Rated Current (A)	Nominal Cold DCR (Ω)*	Nominal I ² t (A ² s)†	Voltage (V _{DC})	Current (A)
0603SFF050F/32	0.50	0.485	0.0029	63	35
0603SFF075F/32	0.75	0.254	0.0064	63	35
0603SFF100F/32	1.00	0.147	0.0160	63	35
0603SFF150F/32	1.50	0.059	0.0300	63	35
0603SFF200F/32	2.00	0.044	0.0600	32	35
0603SFF250F/32	2.50	0.032	0.1150	32	35
0603SFF300F/32	3.00	0.025	0.1900	32	35
0603SFF350F/32	3.50	0.024	0.2950	32	35
0603SFF400F/32	4.00	0.018	0.4000	32	35
0603SFF500F/32	5.00	0.013	0.7000	32	35
0603SFF600F/24	6.00	0.010	1.1250	24	35

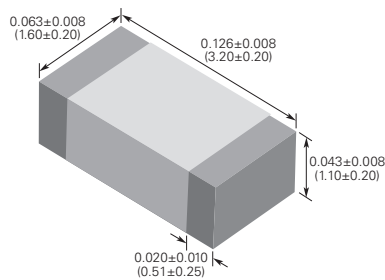
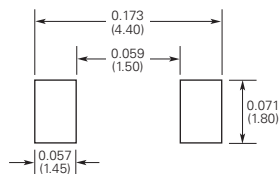
1206 (3216mm) Fast-Acting Chip Fuses
Shape and Dimensions
in (mm)

Recommended Pad Layout
in (mm)

Typical Electrical Characteristics
Max Interrupt Ratings

Part Number	Typical Electrical Characteristics			Max Interrupt Ratings	
	Rated Current (A)	Nominal Cold DCR (Ω)*	Nominal I ² t (A ² s)†	Voltage (V _{DC})	Current (A)
1206SFF050F/63	0.50	0.730	0.0021	63	50
1206SFF075F/63	0.75	0.513	0.0052	63	50
1206SFF100F/63	1.00	0.220	0.0120	63	50
1206SFF150F/63	1.50	0.120	0.0250	63	50
1206SFF175F/63	1.75	0.100	0.0450	63	50
1206SFF200F/63	2.00	0.050	0.0700	63	50
1206SFF250F/32	2.50	0.035	0.1400	32	50
1206SFF300F/32	3.00	0.031	0.2200	32	50
1206SFF400F/32	4.00	0.022	0.3800	32	45
1206SFF500F/32	5.00	0.015	0.6000	32	45
1206SFF600F/32	6.00	0.013	1.0000	32	50
1206SFF700F/32	7.00	0.011	1.7500	32	50
1206SFF800F/32	8.00	0.008	2.5000	32	50
1206SFF600F/24	6.00	0.013	1.0000	24	45
1206SFF700F/24	7.00	0.011	1.7500	24	45
1206SFF800F/24	8.00	0.008	2.5000	24	45

* Measured at ≤10% of rated current and 25°C ambient temperature.
† Melting I²t at 0.001 sec clear time.

Figures FF1-FF6 Family Performance Curves for Fast-Acting Chip Fuses

Figure FF1

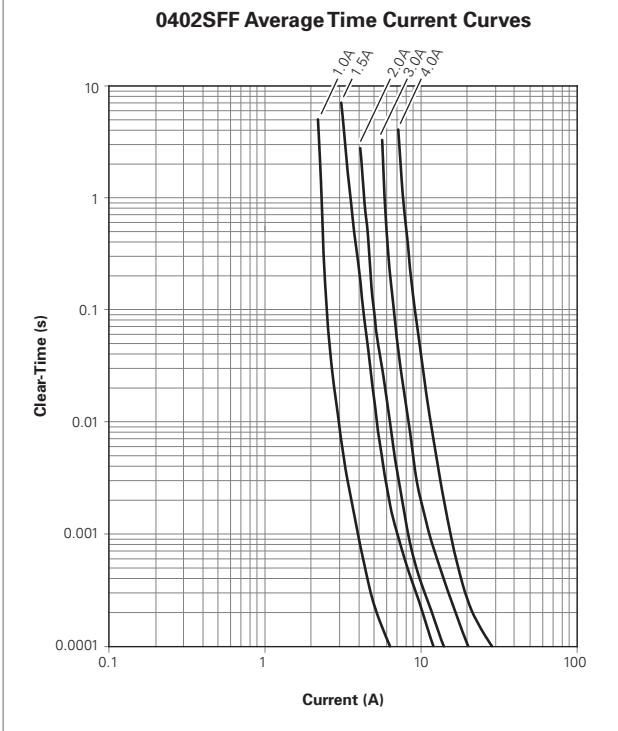
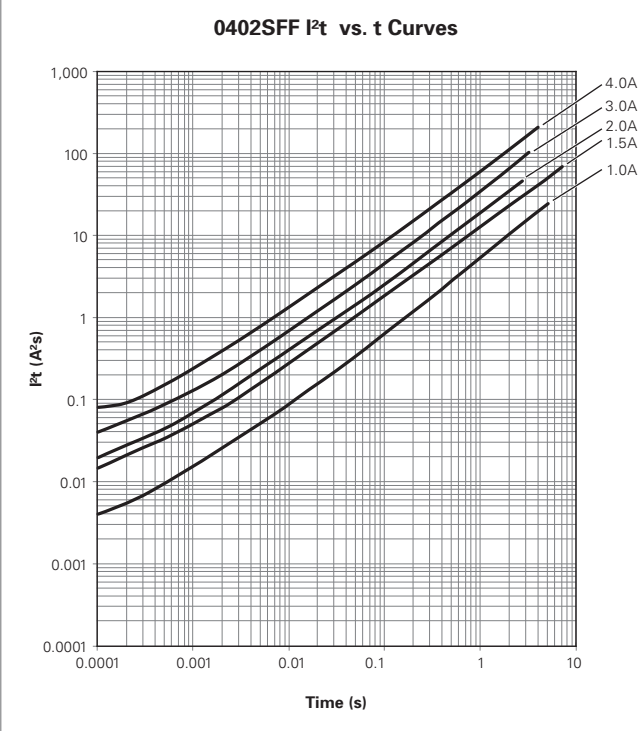

Figure FF2



Note: Curves are nominal

Figure FF3

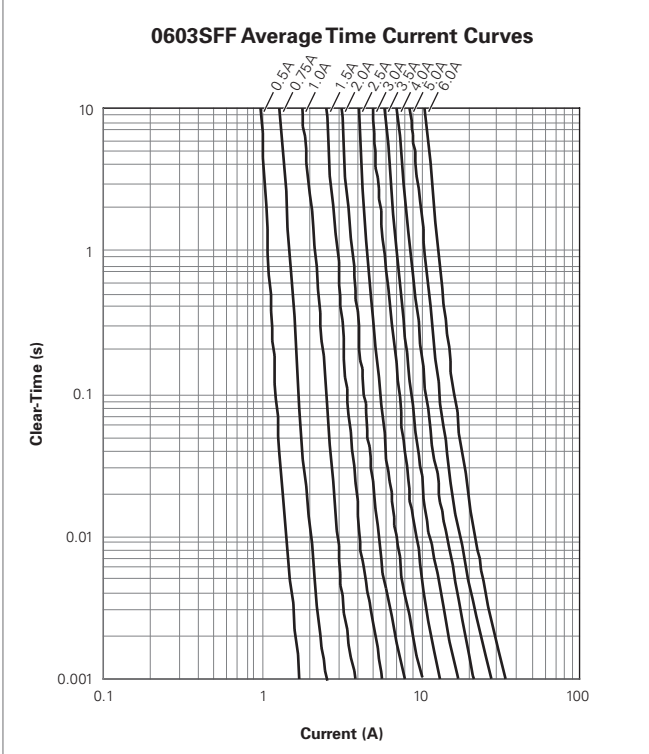
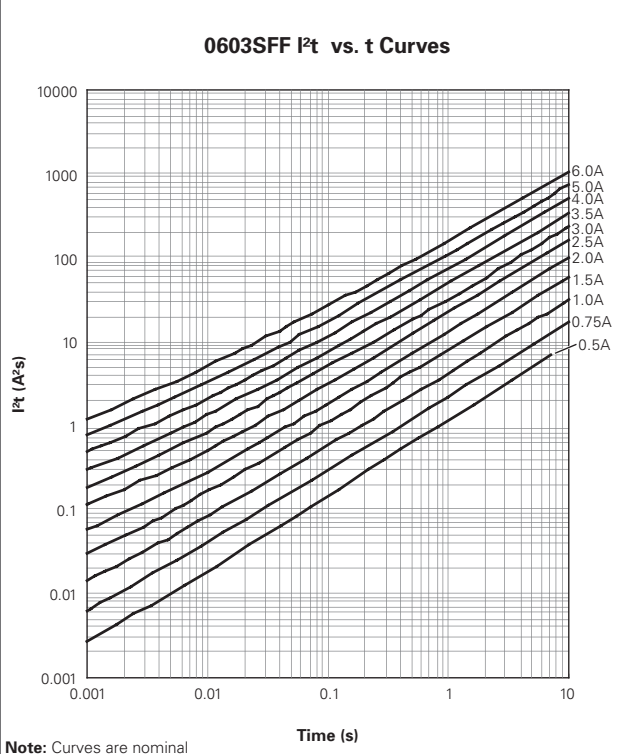

Figure FF4



Note: Curves are nominal

Figure FF5



Figure FF6



→ Please go to page 129 for more information about Fast-Acting Chip Fuses.



Surface-Mount Fuses

High-Current-Rated Chip Fuses

The monolithic multilayer design of the TE Circuit Protection high-current-rated chip fuses helps to provide some of the highest current ratings available in the 1206 size and enhances high-temperature performance in a wide range of circuit protection designs. The devices' small size, high reliability and strong arc suppression characteristics make them suitable for overcurrent protection of power supplies, servers, communications equipment, voltage regulator modules, and other high-current, small size applications.

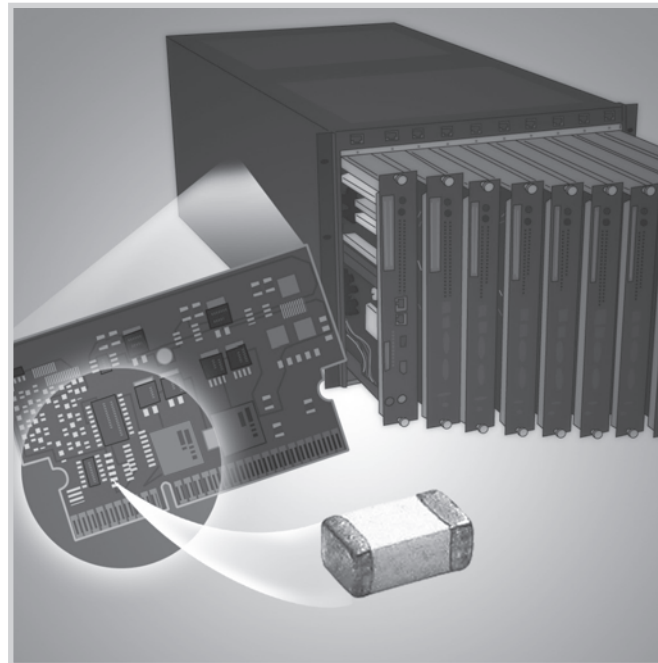

Benefits

- Glass ceramic monolithic structure provides stability in application cycling
- High-current rating in a small package allows more efficient use in system space
- Strong arc suppression in overcurrent conditions

Features

- Lead-free materials and RoHS compliant
- Halogen free
(refers to: Br≤900ppm, Cl≤900ppm, Br+Cl≤1500ppm)
- Monolithic multilayer design
- High-temperature performance
- -55°C to +125°C operating temperature range

Applications

- Communications equipment
- Voltage regulator modules
- Power supplies
- Servers

Table FH1 Clear Time Characteristics for High-Current-Rated Chip Fuses

1206SFH Series

% of Rated Current	Clear Time at 25°C
100%	4 hrs (min)
250%	5 s (max)

Table FH2 Typical Electrical Characteristics, Dimensions and Recommended Pad Layout for High-Current-Rated Chip Fuses

1206 (3216mm) High-Current-Rated Chip Fuses

Shape and Dimensions
in (mm)



Recommended Pad Layout
in (mm)

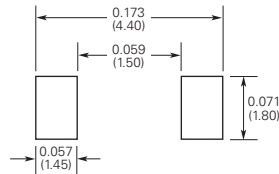

Part Number	Typical Electrical Characteristics			Max Interrupt Ratings	
	Rated Current (A)	Nominal Cold DCR (Ω)*	Nominal I ² t (A ² s)†	Voltage (V _{DC})	Current (A)
1206SFH100F/24	10	0.010	9	24	100
1206SFH120F/24	12	0.008	14	24	100
1206SFH150F/24	15	0.005	26	24	100
1206SFH200F/24	20	0.003	56	24	100

* Measured at ≤10% of rated current and 25°C ambient temperature.
† Melting I²t at 0.001 sec clear time.

Figures FH1-FH2 Family Performance Curves for High-Current-Rated Chip Fuses

Figure FH1

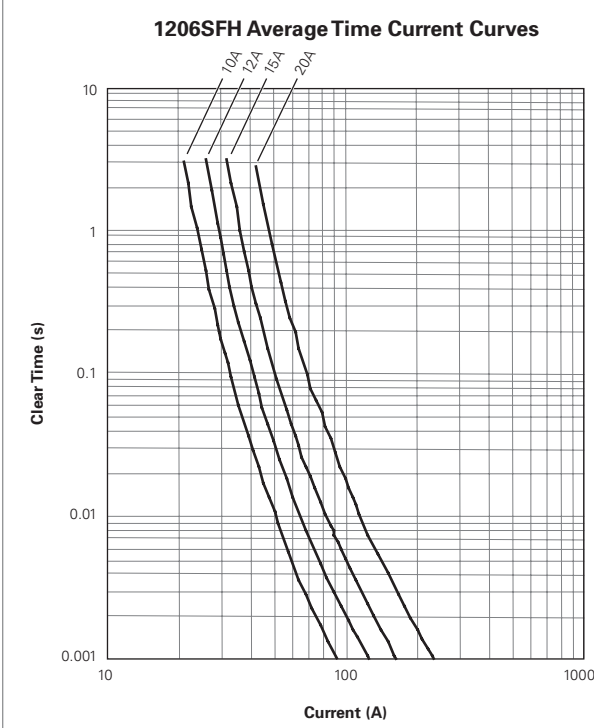
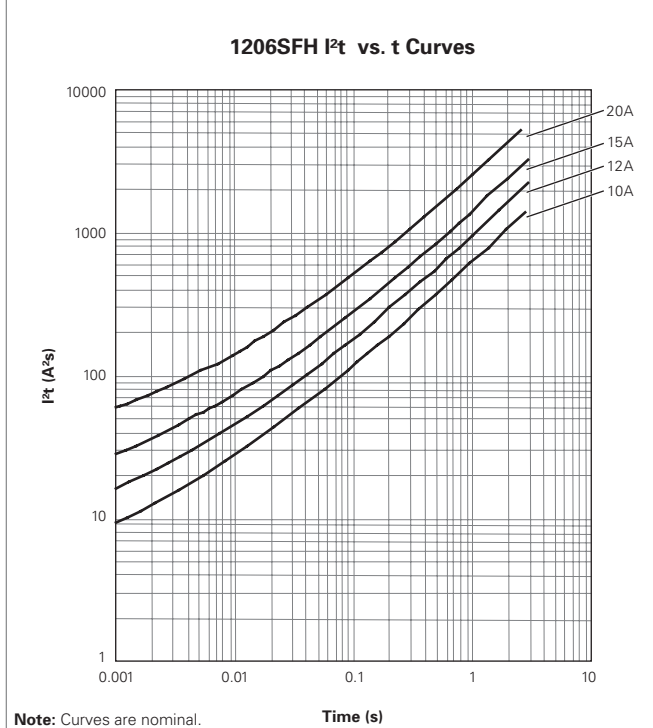

Figure FH2



Note: Curves are nominal.

→ Please go to page 129 for more information about High-Current-Rated Chip Fuses.



Surface-Mount Fuses

Slow-Blow Chip Fuses

Available in industry standard 1206 and 0603 chip sizes, TE Circuit Protection’s slow-blow chip fuses help provide overcurrent protection on systems that experience large and frequent current surges as part of their normal operation.

The slow-blow chip fuse’s monolithic, multilayer design helps provide some of the highest current ratings available in the 1206 and 0603 footprints and enhances high-temperature performance in a wide range of circuit protection designs. The devices’ small size, high reliability and strong arc suppression characteristics make them suitable for overcurrent protection of power supplies, capacitor filter banks, Liquid Crystal Display (LCD) backlight inverters, electric motors and portable electronics.



Benefits

- Time-delayed design help prevent nuisance openings in pulsed and high inrush current applications
- Small size with high-current ratings
- Strong arc suppression characteristics

Features

- Lead-free materials and RoHS compliant
- Halogen free
(refers to: Br≤900ppm, Cl≤900ppm, Br+Cl≤1500ppm)
- Monolithic multilayer design
- High-temperature performance
- -55°C to +125°C operating temperature range

Applications

- | | | |
|------------------------|-----------------------------|-------------------|
| • Small motor systems | • Power over Ethernet (PoE) | • Computer drives |
| • Portable electronics | • Test equipment | • Displays |
| • Input power ports | • POL converter protection | • Printers |

Table FS1 Clear Time Characteristics for Slow-Blow Chip Fuses

0603SFS Series

% of Rated Current	Clear Time at 25°C	
100%	4 hrs (min)	
200%	1 s (min)	120 s (max)
300%	0.1 s (min)	3 s (max)
800% (1.0A-1.5A)	0.0005 s (min)	0.05 s (max)
800% (2.0A-5.0A)	0.001 s (min)	0.05 s (max)

1206SFS Series

% of Rated Current	Clear Time at 25°C	
100%	4 hrs (min)	
200%	1 s (min)	120 s (max)
300%	0.1 s (min)	3 s (max)
800% (1.0A-1.5A)	0.0016 s (min)	0.05 s (max)
800% (2.0A-8.0A)	0.002 s (min)	0.05 s (max)

Table FS2 Typical Electrical Characteristics, Dimensions and Recommended Pad Layout for Slow-Blow Chip Fuses

0603 (1608mm) Slow-Blow Chip Fuses

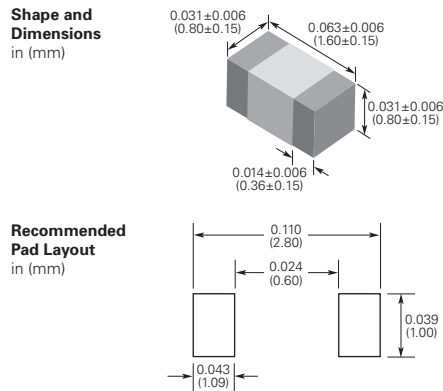

Part Number	Typical Electrical Characteristics			Max Interrupt Ratings	
	Rated Current (A)	Nominal Cold DCR (Ω)*	Nominal I ² t (A ² s)†	Voltage (V _{DC})	Current (A)
0603SFS100F/32	1.0	0.200	0.093	32	50
0603SFS150F/32	1.5	0.100	0.18	32	50
0603SFS200F/32	2.0	0.052	0.32	32	50
0603SFS250F/32	2.5	0.041	0.63	32	50
0603SFS300F/32	3.0	0.031	0.87	32	50
0603SFS350F/32	3.5	0.021	1.20	32	50
0603SFS400F/32	4.0	0.017	2.30	32	50
0603SFS450F/32	4.5	0.015	2.70	32	50
0603SFS500F/32	5.0	0.013	3.20	32	50

1206 (3216mm) Slow-Blow Chip Fuses



Part Number	Typical Electrical Characteristics			Max Interrupt Ratings	
	Rated Current (A)	Nominal Cold DCR (Ω)*	Nominal I ² t (A ² s)†	Voltage (V _{DC})	Current (A)
1206SFS100F/63	1.0	0.360	0.11	63	50
1206SFS125F/63	1.25	0.200	0.22	63	50
1206SFS150F/63	1.5	0.150	0.23	63	50
1206SFS200F/63	2.0	0.088	0.63	63	50
1206SFS250F/32	2.5	0.065	0.90	32	50
1206SFS300F/32	3.0	0.034	1.20	32	50
1206SFS350F/32	3.5	0.028	1.60	32	50
1206SFS400F/32	4.0	0.024	2.20	32	50
1206SFS450F/32	4.5	0.020	3.60	32	50
1206SFS500F/32	5.0	0.016	5.30	32	50
1206SFS550F/24	5.5	0.014	6.40	24	50
1206SFS600F/24	6.0	0.011	8.50	24	60
1206SFS700F/24	7.0	0.010	10.00	24	60
1206SFS800F/24	8.0	0.009	16.90	24	60

* Measured at ≤10% of rated current and 25°C ambient temperature.
 † Melting I²t at 0.001 s clear time.

Figures FS1-FS4 Family Performance Curves for Slow-Blow Chip Fuses

Figure FS1

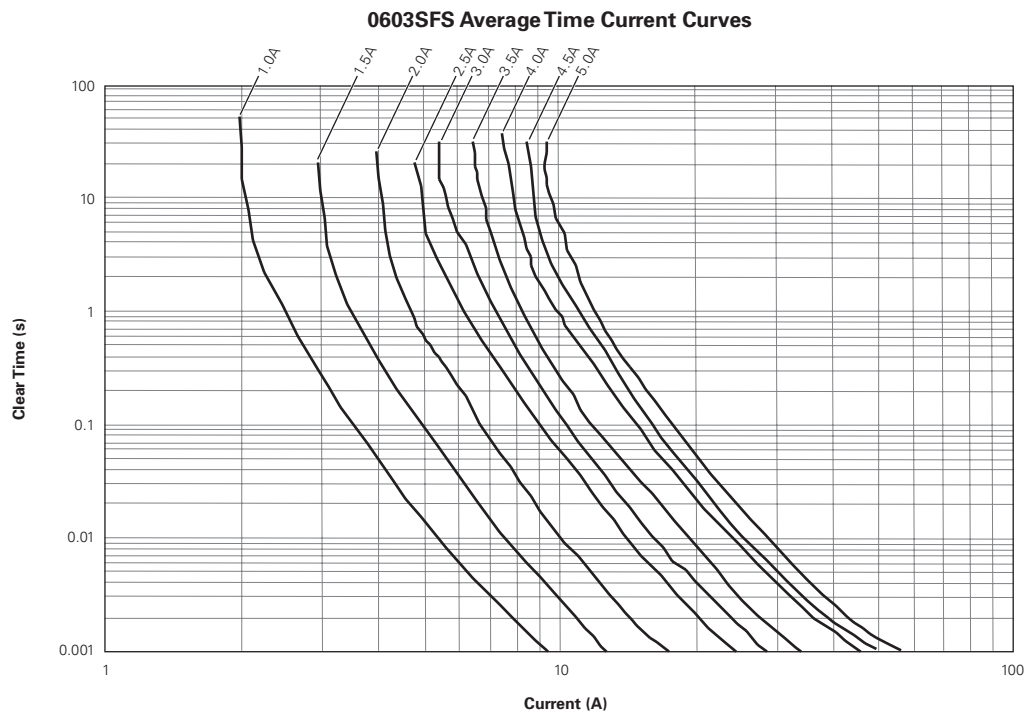
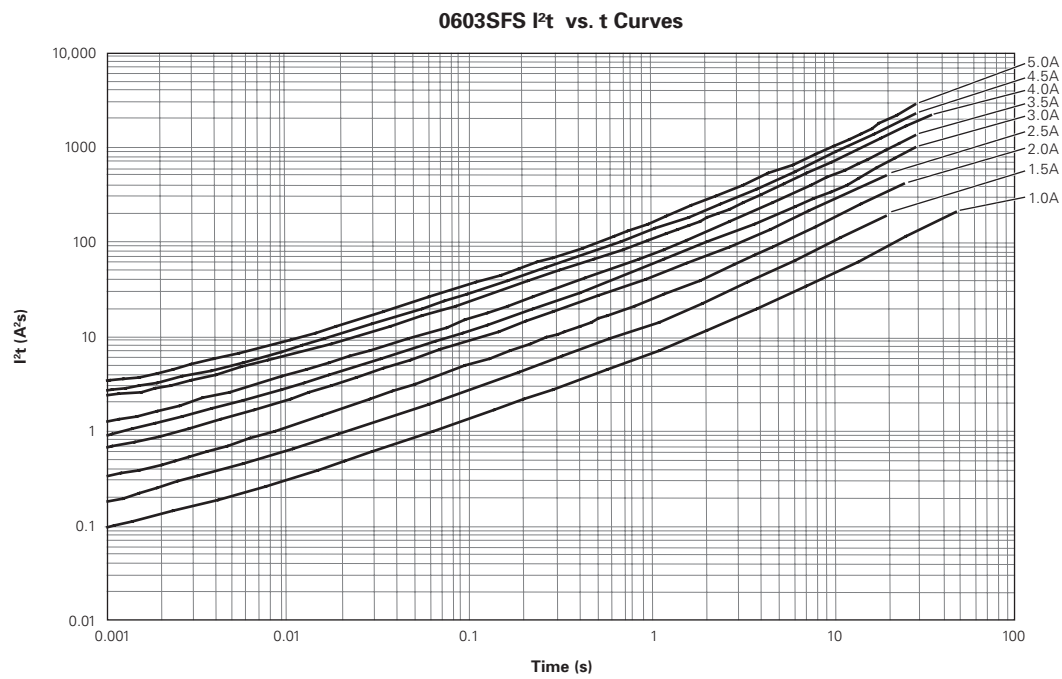

Figure FS2



Note: Curves are nominal.

Figure FS3

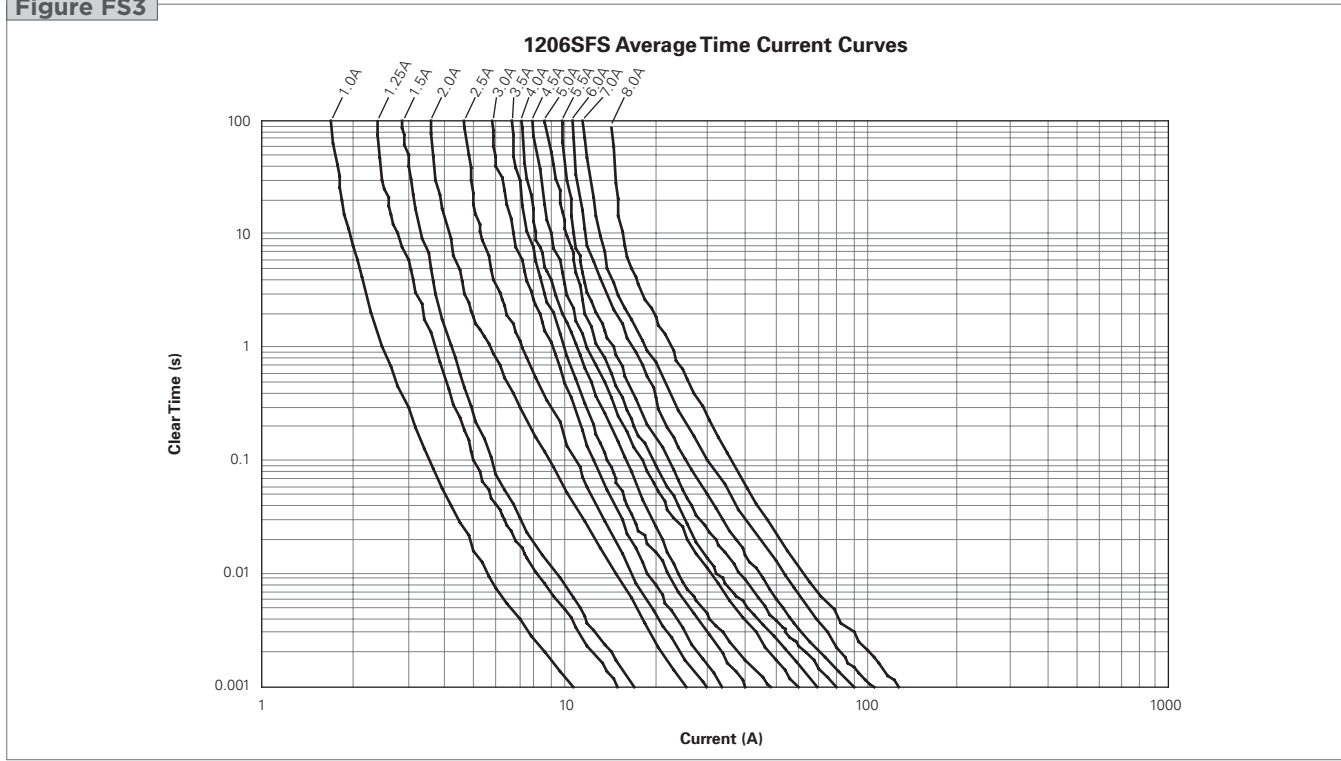
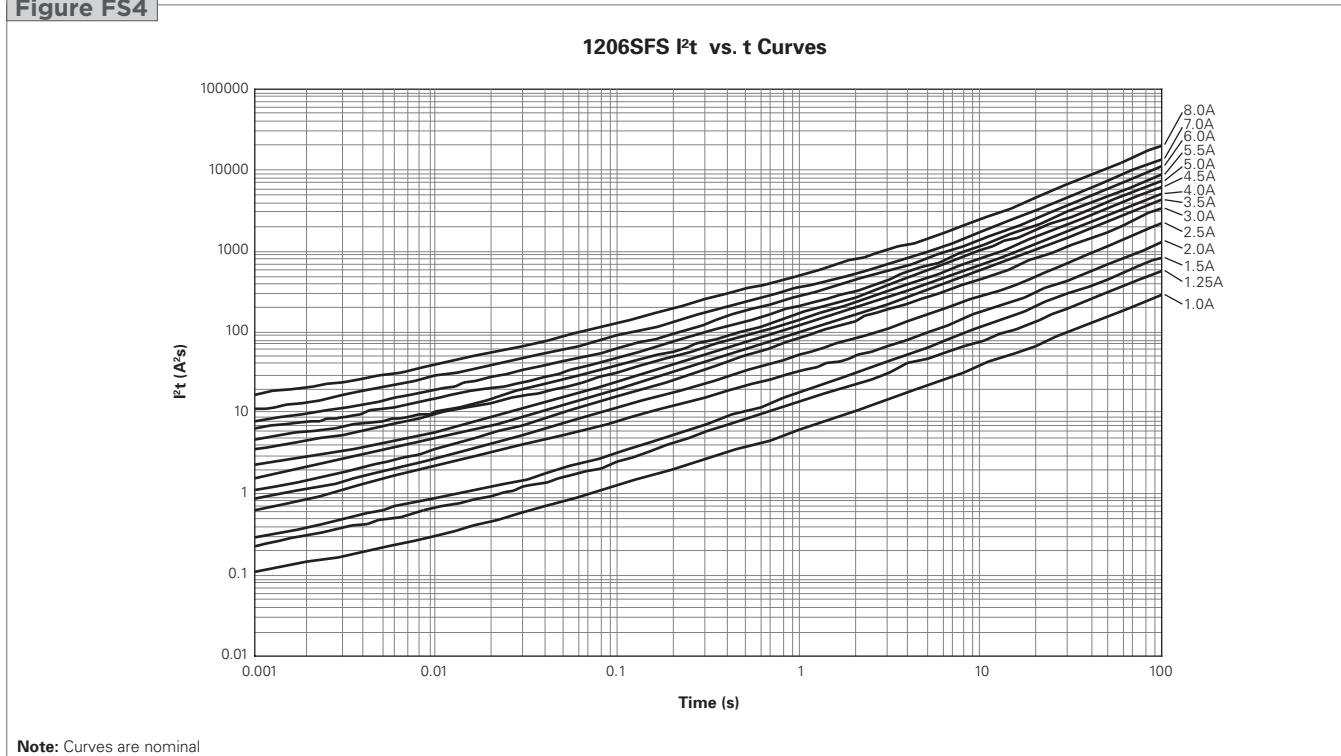
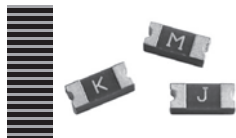

Figure FS4



10

→ Please go to page 129 for more information about Slow-Blow Chip Fuses.



Surface-Mount Fuses

2410 Very Fast-Acting Fuses



The 2410 (6125mm) Wire-in-Air (WIA) SMD Fuse is suitable for secondary-level overcurrent protection applications.

These lead-free surface-mount devices offer increased reliability and avoid the risk of end caps falling off. Their straight wire element in air performs consistent fusing and cutting characteristics.



Benefits

- Very fast acting at 200% overload current level
- Excellent inrush current withstand capability
- High reliability and resilience
- Strong arc suppression characteristics
- Copper terminal with nickel and tin plating

Features

- Halogen free, RoHS compliant and 100% lead free
- Copper or copper alloy composite fuse link
- Fiberglass enforced epoxy fuse body
- Wide range of current rating
- -55°C to +125°C operating temperature range (with de-rating)

Applications

- | | | |
|------------------------|------------------|----------------|
| • Industrial equipment | • Power supplier | • Game systems |
| • LCD/PDP TV | • Telecom system | • White goods |
| • Backlight inverter | • Networking | • Automotive |

Table SFV1 Clear Time Characteristics for 2410 Very Fast-Acting Fuses

% of Rated Current	Clear Time at 25°C	
100%	4 hrs (min)	
200% (0.5A-10.0A)	0.01 s (min)	5 s (max)
200% (12.0A-20.0A)	0.01 s (min)	20 s (max)

Table SFV2 Typical Electrical Characteristics, Dimensions and Recommended Pad Layout for 2410 Very Fast-Acting Fuses

2410 (6125mm) Very Fast-Acting Fuse

Shape and Dimensions
mm (in)

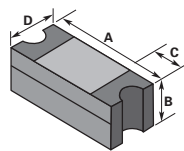

	A		B		C		D	
	Min	Max	Min	Max	Min	Max	Min	Max
mm	5.95	6.25	1.96	2.36	0.97	1.73	2.34	2.64
in	(0.234)	(0.246)	(0.077)	(0.093)	(0.038)	(0.068)	(0.092)	(0.104)

Recommended Pad Layout
mm (Inch)

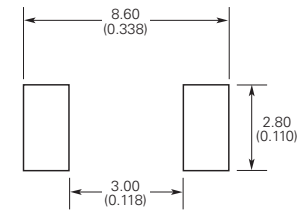

Part Number	Marking Code	Rated Current (A)	Interrupt Rating	Voltage Rating (V)		Nominal Cold DC Resistance (DCR) (Ω)*	Nominal I ² t (A ² s)	
				AC	DC			
2410SFV0.50FM/125	C	0.5	UL: 0.5~2A 100A @ 250V _{AC} 2.5~8A 50A @ 125V _{AC} 0.5~8A 50A @ 125V _{DC} 300A @ 32V _{DC} TUV: 0.5~2A 100A @ 250V _{AC} 50A @ 125V _{DC} CQC: 0.5A, 1A, 2A 100A @ 250V _{AC} 50A @ 125V _{DC}	250	125	0.231	0.1	
2410SFV0.63FM/125	S	0.63		250	125	0.174	0.16	
2410SFV0.75FM/125	D	0.75		250	125	0.148	0.23	
2410SFV1.00FM/125	E	1		250	125	0.093	0.59	
2410SFV1.25FM/125	F	1.25		250	125	0.07	0.96	
2410SFV1.50FM/125	G	1.5		250	125	0.062	1.19	
2410SFV2.00FM/125	I	2		250	125	0.042	2.75	
2410SFV2.50FM/125	J	2.5		125	125	0.031	1.21	
2410SFV3.00FM/125	K	3		125	125	0.0249	1.73	
2410SFV3.15FM/125	V	3.15		125	125	0.0232	2.2	
2410SFV3.50FM/125	L	3.5		125	125	0.022	2.5	
2410SFV4.00FM/125	M	4		125	125	0.0172	4.1	
2410SFV5.00FM/125	N	5		125	125	0.0143	5.9	
2410SFV6.30FM/125	O	6.3		125	125	0.01	12.5	
2410SFV7.00FM/125	P	7		125	125	0.0094	14.2	
2410SFV8.00FM/125	R	8		125	125	0.0086	20.3	
2410SFV10.0FM/125	Q	10		UL: 35A @ 125V _{AC} 50A @ 125V _{DC} 300A @ 32V _{DC}	125	125	0.0066	29.2
2410SFV12.0FM/065	X	12		UL: 50A @ 65V _{AC} 50A @ 65V _{DC} 300A @ 32V _{DC}	65	65	0.0053	49.2
2410SFV15.0FM/065	Y	15	UL: 50A @ 65V _{AC} 50A @ 65V _{DC} 300A @ 32V _{DC}	65	65	0.0038	102.5	
2410SFV20.0FM/065	Z	20	UL: 50A @ 65V _{AC} 100A @ 65V _{DC} 300A @ 32V _{DC}	65	65	0.0034	126.2	

* Measured at ≤10% of rated current and 25°C ambient

Figures SFV1-SFV2 Family Performance Curves for 2410 Very Fast-Acting Fuses

Figure SFV1

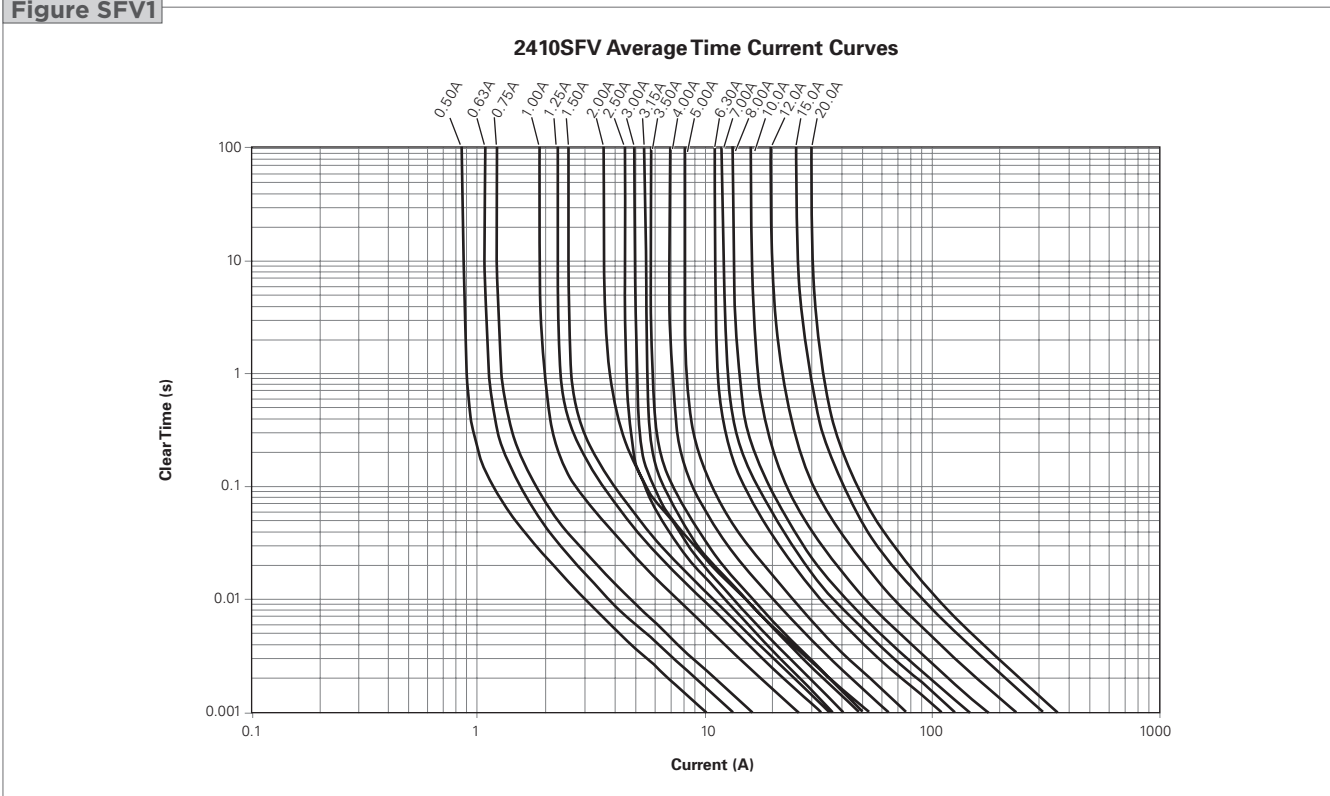
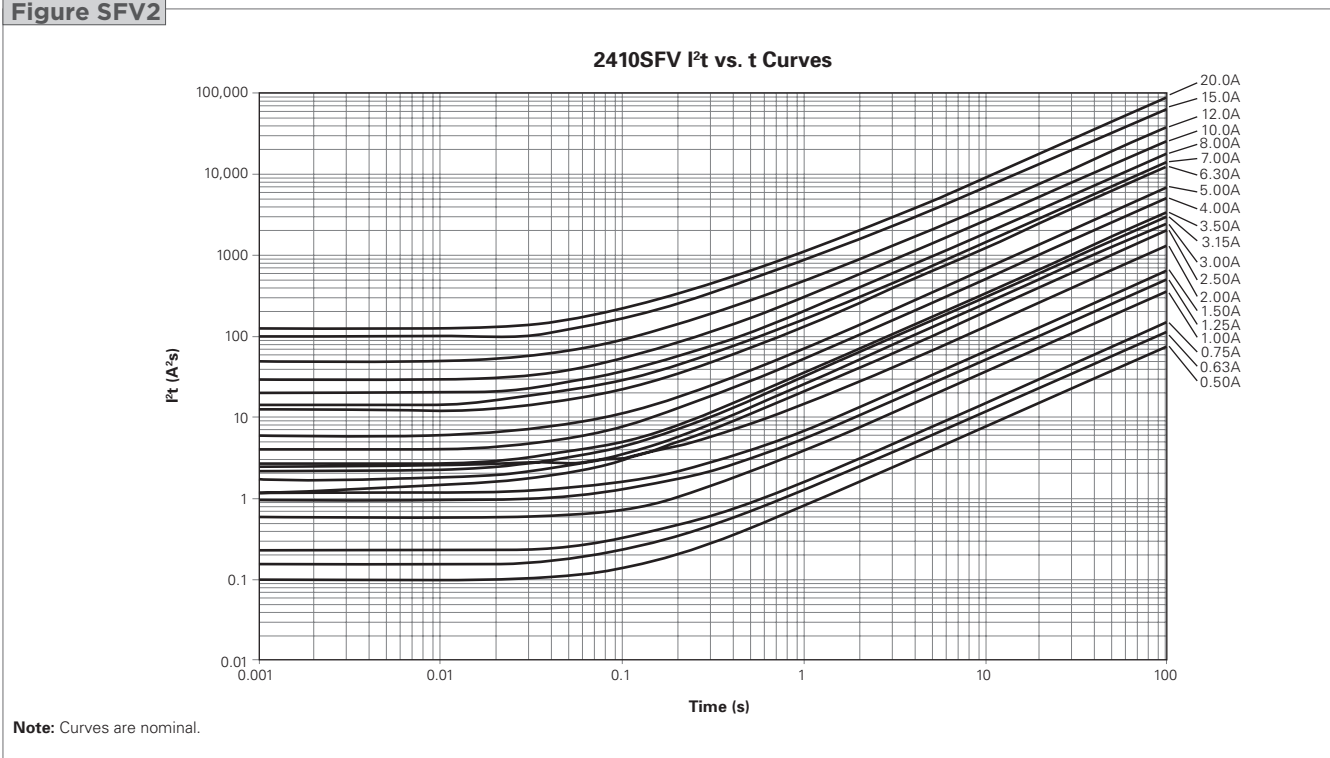

Figure SFV2



→ Please go to page 129 for more information about 2410 Fast-Acting Fuses.

RoHS Compliant, ELV Compliant

HF Halogen Free



Specifications, Packaging Information, Agency Approvals and Part Numbering Systems for All Fuses

Table F1 Environmental Specifications for All Fuses

Operating Temperature	-55°C to +125°C
Mechanical Vibration	Withstands 5-3000 Hz at 30Gs when evaluated per Method 204 of MIL-STD-202
Mechanical Shock	Withstands 1500Gs, 0.5 millisecond half-sine pulses when evaluated per Method 213 of MIL-STD-202
Thermal Shock	Withstands 100 cycles from -65°C to +125°C when evaluated per Method 107 of MIL-STD-202
Resistance to Soldering Heat	Withstands 60 seconds at +260°C when evaluated per Method 210 of MIL-STD-202
Solderability	Meets 95% minimum coverage requirement when evaluated per Method 208 of MIL-STD-202
Moisture Resistance	Withstands 10 cycles when evaluated per Method 106 of MIL-STD-202
Salt Spray	Withstands 48-hour exposure when evaluated per Method 101 of MIL-STD-202
Storage Temperature	≤30°C/ 85% RH
Storage Humidity	Per MIL-STD-202F, Method 106F

Table F2 Material Specifications for All Fuses

Construction Body Material	Ceramic (1206/0603/0402); Fiberglass/Epoxy (2410)
Termination Material	Silver, Nickel, Tin
Fuse Element	Silver(1206/0603/0402); Copper/Copper Alloy (2410)

Figure F1 Thermal Derating Current for All Fuses

Table F3 Electrical Specifications for All Fuses

Insulation Resistance after Opening	20,000Ω minimum @ rated voltage. Fuse clearing under low-voltage conditions may result in lower post-clearing insulation values. Under normal fault conditions TE Circuit Protection fuses help provide sufficient insulation resistance for circuit protection.
Current Carrying Capacity	Withstands 100% rated current at +25°C ambient for 4 hours when evaluated per MIL-PRF-23419.

Table F4 Packaging Information for All Fuses

Size	Reel Quantity (pcs)	Reel Diameter	Reel Width	Carrier Tape Size	Tape Type	Reels per Outside Shipment Box	Outside Shipment Boxes per Overpack
0402 (1005)	10,000	178mm White Plastic	9.0 ± 0.5mm	8.00 ± 0.10mm	Paper	5	1 to 10
0603 (1608)	4,000	178mm White Plastic	9.0 ± 0.5mm	8.00 ± 0.10mm	Paper	5	1 to 10
0603SFV (1608)	6,000	178mm White Plastic	9.0 ± 0.5mm	8.00 ± 0.10mm	Paper	5	1 to 10
1206 (3216)	3,000	178mm White Plastic	9.0 ± 0.5mm	8.00 ± 0.10mm	Plastic	5	1 to 10
2410 (6125)	2,000	178mm White Plastic	13.4 ± 0.5mm	12.00 ± 0.10mm	Plastic	4	1 to 10

Figure F2 Recommended Soldering Temperature Profile for All Fuses



Classification Reflow Profiles

Profile Feature	1206/0603/0402	2410
Average Ramp Up Rate (Ts_{MAX} to Tp)	3°C/second max	3°C/second max
Preheat		
• Temperature min (Ts _{MIN})	150°C	150°C
• Temperature max (Ts _{MAX})	200°C	200°C
• Time (ts _{MIN} to ts _{MAX})	60-180 seconds	40-100 seconds
Time Maintained Above:		
• Temperature (T _L)	217°C	200°C
• Time (t _L)	60-150 seconds	30-90 seconds
Peak/Classification Temperature (Tp)	260°C max	250°C max
Time Within 5°C of Actual Peak Temperature		
Time (tp)	20-40 seconds	30-40 seconds
From 25°C to Preheating (150°C)	8 minutes max	40-100 seconds
Ramp Down Rate	4°C/seconds max	Natural Cooling

Recommended Conditions for Hand Soldering:

- Using a hot air rework station that can reflow the solder on both terminations at the same time is strongly recommended; do not directly contact the chip termination with the tip of soldering iron.
- Preheating: 150°C, 60s (min)
Appropriate temperature (max) of soldering iron tip/soldering time (max): 280°C /10s or 350°C /3s.

Table F4 Packaging Information for All Fuses

(Cont'd)

Mark	Dimension in in (mm)				
	0402 (1005)	0603 (1608)	1206 (3216)	0603SFV (1608)	2410 (6125)
E_1	0.069 ± 0.004 (1.75 ± 0.10)	0.069 ± 0.004 (1.75 ± 0.10)	0.069 ± 0.004 (1.75 ± 0.10)	0.069 ± 0.004 (1.75 ± 0.10)	0.069 ± 0.004 (1.75 ± 0.10)
F	0.138 ± 0.002 (3.50 ± 0.05)	0.138 ± 0.002 (3.50 ± 0.05)	0.138 ± 0.002 (3.50 ± 0.05)	0.138 ± 0.002 (3.50 ± 0.05)	0.217 ± 0.004 (5.50 ± 0.10)
W	0.315 ± 0.004 (8.00 ± 0.10)	0.315 ± 0.004 (8.00 ± 0.10)	0.315 ± 0.004 (8.00 ± 0.10)	0.315 ± 0.004 (8.00 ± 0.10)	0.472 ± 0.004 (12.00 ± 0.10)
P_1	0.079 ± 0.004 (2.00 ± 0.10)	0.157 ± 0.004 (4.00 ± 0.10)	0.157 ± 0.004 (4.00 ± 0.10)	0.157 ± 0.004 (4.00 ± 0.10)	0.157 ± 0.004 (4.00 ± 0.10)
P_0	0.157 ± 0.004 (4.00 ± 0.10)	0.157 ± 0.004 (4.00 ± 0.10)	0.157 ± 0.004 (4.00 ± 0.10)	0.157 ± 0.004 (4.00 ± 0.10)	0.157 ± 0.004 (4.00 ± 0.10)
P_2	0.079 ± 0.002 (2.00 ± 0.05)	0.079 ± 0.002 (2.00 ± 0.05)	0.079 ± 0.002 (2.00 ± 0.05)	0.079 ± 0.002 (2.00 ± 0.05)	0.079 ± 0.004 (2.00 ± 0.10)
D_0	0.059 ± 0.004 (1.50+0.10/-0.00)	0.059 ± 0.004 (1.50+0.10/-0.00)	0.059 ± 0.004 (1.50+0.10/-0.00)	0.059 ± 0.004 (1.50+0.10/-0.00)	0.059 ± 0.004 (1.50+0.10/-0.00)
D_1	—	—	0.039 max (1.00 max)	—	0.61 ± 0.004 (1.55 ± 0.10)
t	—	—	0.009 ± 0.001 (0.23 ± 0.02)	—	0.010 ± 0.002 (0.25 ± 0.05)
A_0	0.026 ± 0.004 (0.67 ± 0.10)	0.039 ± 0.004 (0.98 ± 0.10)	0.071 ± 0.004 (1.80 ± 0.10)	0.039 ± 0.004 (0.98 ± 0.10)	0.112 ± 0.004 (2.85 ± 0.10)
B_0	0.046 ± 0.004 (1.17 ± 0.10)	0.071 ± 0.004 (1.80 ± 0.10)	0.138 ± 0.004 (3.50 ± 0.10)	0.071 ± 0.004 (1.80 ± 0.10)	0.252 ± 0.004 (6.40 ± 0.10)
K_0	0.025 ± 0.004 (0.63 ± 0.10)	0.037 ± 0.003 (0.95 ± 0.08)	0.050 ± 0.004 (1.27 ± 0.10)	0.024 ± 0.003 (0.60 ± 0.08)	0.093 ± 0.004 (2.35 ± 0.10)

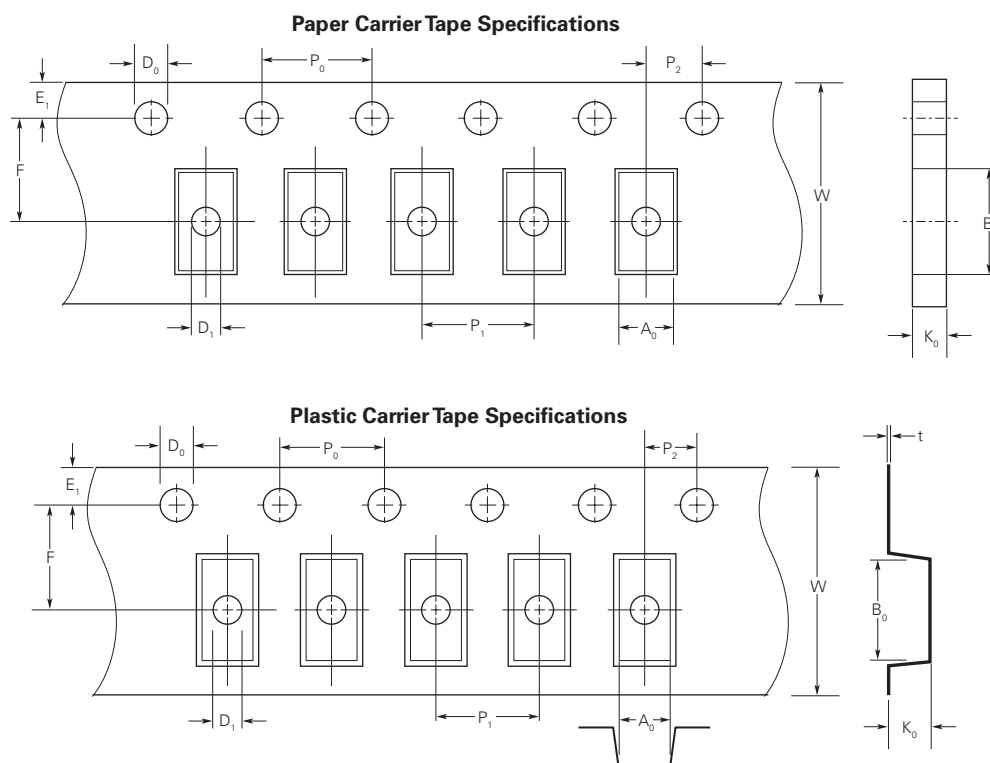
Figure F3 Component Tape Dimensions for All Fuses

10

Figure F4 Reel Dimensions for All Fuses

Dimension Description	Mark	Dimension (mm)	
		1206/0603/0402	2410
Hub Outer Diameter	B	60	60.2
Reel Inside Width	W ₁	9	13.4
Reel Outside Width	W ₂	11.4	16
Tape Width		8	

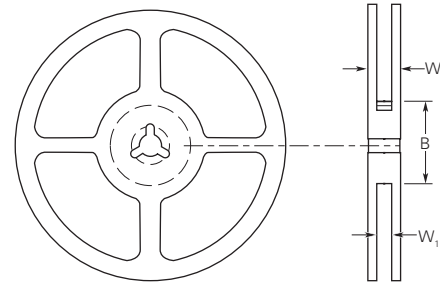

Agency Approvals for All Fuses

UL: All fuses
 CQC: File # 12012078873 (for 2410SFV 0.5A, 1A, 2A)
 TUV: File # 50236400 (for 2410SFV 0.5A, 0.63A, 1A, 1.25A, 2A)

Part Numbering System for Fast-Acting, Slow-Blow and 0603 Very Fast-Acting Chip Fuses



10

Part Numbering System for High-Current-Rated Chip Fuses



Part Numbering System for 2410 Very Fast-Acting Fuses

Notice :

Information furnished is believed to be accurate and reliable. However, users should independently evaluate the suitability and test each product selected for their own applications. Tyco Electronics Corporation and its affiliates in the TE Connectivity Ltd. group of companies ("TE") reserves the right to change or update, without notice, any information contained in this publication; to change, without notice, the design, construction, processing, or specification of any product; and to discontinue or limit production or distribution of any product. This publication supersedes and replaces all information previously supplied. Without express written consent by an officer of TE, TE does not authorize the use of any of its products as components in nuclear facility applications, aerospace, or in critical life support devices or systems. TE expressly disclaims all implied warranties regarding the information contained herein, including, but not limited to, any implied warranties of merchantability or fitness for a particular purpose. TE's only obligations are those in the TE Standard Terms and Conditions of Sale and in no case will TE be liable for any incidental, indirect, or consequential damages arising from the sale, resale, use, or misuse of its products.

Looking for pricing, stock, or lifecycle information?

Click below to explore more details on WIN SOURCE:

- [View 0402SFF200F/24-2 on WIN SOURCE](#)
- [Littelfuse Inc. Information](#)

Optimize Your Supply Chain with WIN SOURCE Solutions

- ✓ Global Sourcing Solution
- ✓ Obsolete Management
- ✓ Cost Control Management
- ✓ Shortage Management
- ✓ Alternative Solution
- ✓ Excess Inventory Management