

NLSX4373

2-Bit 20 Mb/s Dual-Supply Level Translator

The NLSX4373 is a 2-bit configurable dual-supply bidirectional auto sensing translator that does not require a directional control pin. The V_{CC} I/O and V_L I/O ports are designed to track two different power supply rails, V_{CC} and V_L respectively. The V_{CC} supply rail is configurable from 1.5 V to 5.5 V while V_L supply rail is configurable to 1.5 V to 5.5 V. This allows voltage logic signals on the V_L side to be translated into lower, higher or equal value voltage logic signals on the V_{CC} side, and vice-versa.

The NLSX4373 translator has open-drain outputs with integrated 10 k Ω pullup resistors on the I/O lines. The integrated pullup resistors are used to pullup the I/O lines to either V_L or V_{CC} . The NLSX4373 is an excellent match for open-drain applications such as the I²C communication bus.

Features

- V_L can be Less than, Greater than or Equal to V_{CC}
- Wide V_{CC} Operating Range: 1.5 V to 5.5 V
Wide V_L Operating Range: 1.5 V to 5.5 V
- High-Speed with 20 Mb/s Guaranteed Date Rate
- Low Bit-to-Bit Skew
- Enable Input and I/O Lines have Overvoltage Tolerant (OVT) to 5.5 V
- Nonpreferential Powerup Sequencing
- Integrated 10 k Ω Pullup Resistors
- Small packaging: UDFN8, SO-8, Micro8
- NLV Prefix for Automotive and Other Applications Requiring Unique Site and Control Change Requirements; AEC-Q100 Qualified and PPAP Capable*
- This is a Pb-Free Device

Typical Applications

- I²C, SMBus, PMBus
- Low Voltage ASIC Level Translation
- Mobile Phones, PDAs, Cameras

Important Information

- ESD Protection for All Pins
 - Human Body Model (HBM) > 7000 V



ON Semiconductor®

<http://onsemi.com>

MARKING DIAGRAMS



UDFN8
MU SUFFIX
CASE 517AJ



- VF = Specific Device Code
- M = Date Code
- = Pb-Free Package



SO-8
D SUFFIX
CASE 751

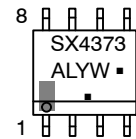

- A = Assembly Location
- L = Wafer Lot
- Y = Year
- W = Work Week
- = Pb-Free Package



Micro8™
DM SUFFIX
CASE 846A

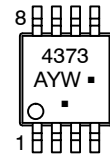

- A = Assembly Location
- Y = Year
- W = Work Week
- = Pb-Free Package

ORDERING INFORMATION

Device	Package	Shipping†
NLSX4373MUTAG	UDFN8 (Pb-Free)	3000/Tape & Reel
NLVSX4373MUTAG*	UDFN8 (Pb-Free)	3000/Tape & Reel
NLSX4373DR2G	SO-8 (Pb-Free)	2500/Tape & Reel
NLVSX4373DR2G*	SO-8 (Pb-Free)	2500/Tape & Reel
NLSX4373DMR2G	Micro8 (Pb-Free)	4000/Tape & Reel

†For information on tape and reel specifications, including part orientation and tape sizes, please refer to our Tape and Reel Packaging Specification Brochure, BRD8011/D.

NLSX4373

LOGIC DIAGRAM

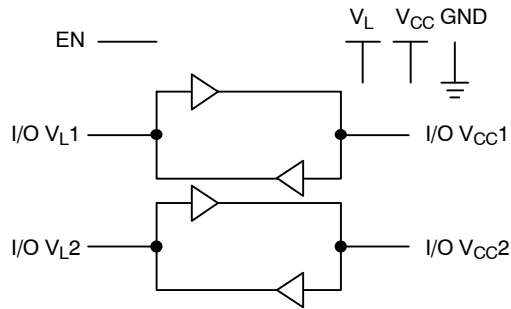

PIN ASSIGNMENTS

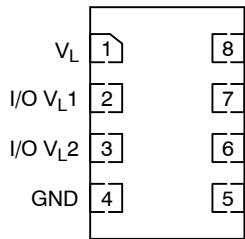

UDFN8
(Top View)

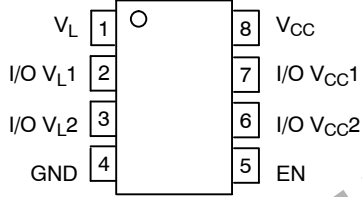

SOIC-8
(Top View)

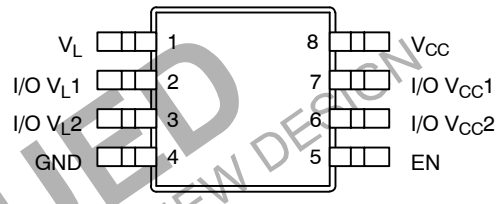

Micro8
(Top View)

PIN ASSIGNMENT

Pins	Description
V _{CC}	V _{CC} Input Voltage
V _L	V _L Input Voltage
GND	Ground
EN	Output Enable
I/O V _{CCn}	V _{CC} I/O Port, Referenced to V _{CC}
I/O V _{Ln}	V _L I/O Port, Referenced to V _L

FUNCTION TABLE

EN	Operating Mode
L	Hi-Z
H	I/O Buses Connected

MAXIMUM RATINGS

Symbol	Parameter	Value	Condition	Unit
V_{CC}	High-side DC Supply Voltage	-0.3 to +7.0		V
V_L	High-side DC Supply Voltage	-0.3 to +7.0		V
I/O V_{CC}	V_{CC} -Referenced DC Input/Output Voltage	-0.3 to ($V_{CC} + 0.3$)		V
I/O V_L	V_L -Referenced DC Input/Output Voltage	-0.3 to ($V_L + 0.3$)		V
V_{EN}	Enable Control Pin DC Input Voltage	-0.3 to +7.0		V
I_{I/O_SC}	Short-Circuit Duration (I/O V_L and I/O V_{CC} to GND)	40	Continuous	mA
T_{STG}	Storage Temperature	-65 to +150		°C

Stresses exceeding Maximum Ratings may damage the device. Maximum Ratings are stress ratings only. Functional operation above the Recommended Operating Conditions is not implied. Extended exposure to stresses above the Recommended Operating Conditions may affect device reliability.

RECOMMENDED OPERATING CONDITIONS

Symbol	Parameter	Min	Max	Unit
V_{CC}	High-side Positive DC Supply Voltage	1.5	5.5	V
V_L	High-side Positive DC Supply Voltage	1.5	5.5	V
V_{EN}	Enable Control Pin Voltage	GND	5.5	V
V_{IO}	Enable Control Pin Voltage	GND	5.5	V
T_A	Operating Temperature Range	-40	+85	°C

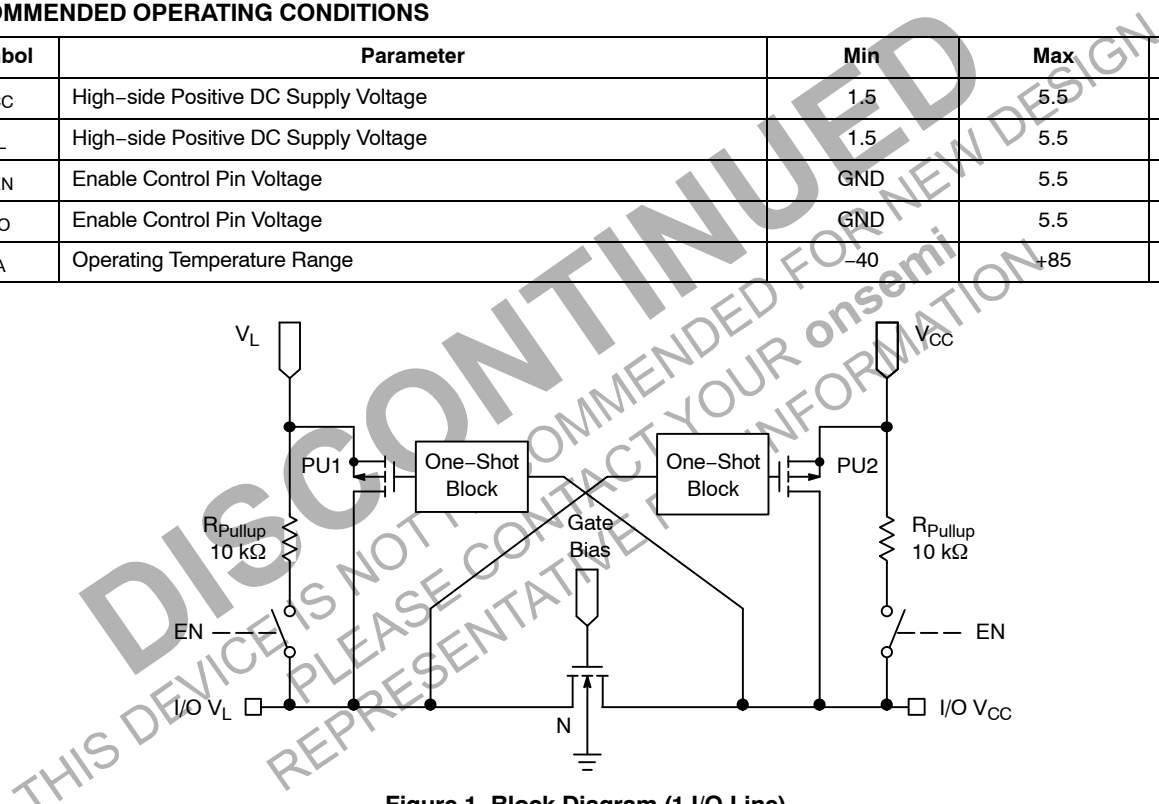

Figure 1. Block Diagram (1 I/O Line)

NLSX4373

DC ELECTRICAL CHARACTERISTICS ($V_{CC} = 1.5\text{ V to }5.5\text{ V}$ and $V_L = 1.5\text{ V to }5.5\text{ V}$, unless otherwise specified)

Symbol	Parameter	Test Conditions	-40°C to +85°C			Unit
			Min	Typ (Notes 1, 2)	Max	
V_{IHC}	I/O V_{CC} Input HIGH Voltage		$V_{CC} - 0.4$	-	-	V
V_{ILC}	I/O V_{CC} Input LOW Voltage		-	-	0.15	V
V_{IHL}	I/O V_L Input HIGH Voltage		$V_L - 0.2$	-	-	V
V_{ILL}	I/O V_L Input LOW Voltage		-	-	0.15	V
V_{IH}	Control Pin Input HIGH Voltage		$V_L - 0.2$	-	-	V
V_{IL}	Control Pin Input LOW Voltage		-	-	0.15	V
V_{OHC}	I/O V_{CC} Output HIGH Voltage	I/O V_{CC} Source Current = 20 μA	$2/3 * V_{CC}$	-	-	V
V_{OLC}	I/O V_{CC} Output LOW Voltage	I/O V_{CC} Sink Current = 20 μA	-	-	$1/3 * V_{CC}$	V
V_{OHL}	I/O V_L Output HIGH Voltage	I/O V_L Source Current = 20 μA	$2/3 * V_L$	-	-	V
V_{OLL}	I/O V_L Output LOW Voltage	I/O V_L Sink Current = 20 μA	-	-	$1/3 * V_L$	V
I_{QVCC}	V_{CC} Supply Current	I/O V_{CC} and I/O V_L Unconnected, $V_{EN} = V_L$	-	0.5	2.0	μA
I_{QVL}	V_L Supply Current	I/O V_{CC} and I/O V_L Unconnected, $V_{EN} = V_L$	-	0.3	1.5	μA
I_{TS-VCC}	V_{CC} Tristate Output Mode Supply Current	I/O V_{CC} and I/O V_L Unconnected, $V_{EN} = \text{GND}$	-	0.1	1.0	μA
I_{TS-VL}	V_L Tristate Output Mode Supply Current	I/O V_{CC} and I/O V_L Unconnected, $V_{EN} = \text{GND}$	-	0.1	1.0	μA
I_{OZ}	I/O Tristate Output Mode Leakage Current	$T_A = +25^\circ\text{C}$	-	0.1	1.0	μA
R_{PU}	Pullup Resistor I/O V_L and V_{CC}	$T_A = +25^\circ\text{C}$	-	10	-	$\text{k}\Omega$

1. Typical values are for $V_{CC} = +2.8\text{ V}$, $V_L = +1.8\text{ V}$ and $T_A = +25^\circ\text{C}$.

2. All units are production tested at $T_A = +25^\circ\text{C}$. Limits over the operating temperature range are guaranteed by design.

DISCONTINUED
THIS DEVICE IS NOT RECOMMENDED FOR NEW DESIGN
PLEASE CONTACT YOUR onsemi REPRESENTATIVE FOR INFORMATION

NLSX4373

TIMING CHARACTERISTICS – RAIL-TO-RAIL DRIVING CONFIGURATIONS

(I/O test circuit of Figures 2 and 3, $C_{LOAD} = 15 \text{ pF}$, driver output impedance $\leq 50 \Omega$, $R_{LOAD} = 1 \text{ M}\Omega$)

Symbol	Parameter	Test Conditions	-40°C to +85°C (Notes 3 and 4)			Unit
			Min	Typ	Max	

$V_L = 1.5 \text{ V}$, $V_{CC} = 5.5 \text{ V}$

t_{RVCC}	I/O V_{CC} Risettime				15	ns
t_{FVCC}	I/O V_{CC} Falltime				20	ns
t_{RVL}	I/O V_L Risettime				30	ns
t_{FVL}	I/O V_L Falltime				10	ns
$t_{PDVL-VCC}$	Propagation Delay (Driving I/O V_L)				20	ns
$t_{PDVCC-VL}$	Propagation Delay (Driving I/O V_{CC})				20	ns
t_{PPSKEW}	Part-to-Part Skew				5	nS
	Maximum Data Rate		20			Mb/s

$V_L = 1.8 \text{ V}$, $V_{CC} = 2.8 \text{ V}$

t_{RVCC}	I/O V_{CC} Risettime				15	ns
t_{FVCC}	I/O V_{CC} Falltime				15	ns
t_{RVL}	I/O V_L Risettime				25	ns
t_{FVL}	I/O V_L Falltime				10	ns
$t_{PDVL-VCC}$	Propagation Delay (Driving I/O V_L)				15	ns
$t_{PDVCC-VL}$	Propagation Delay (Driving I/O V_{CC})				15	ns
t_{PPSKEW}	Part-to-Part Skew				5	nS
	Maximum Data Rate		20			Mb/s

$V_L = 2.5 \text{ V}$, $V_{CC} = 3.6 \text{ V}$

t_{RVCC}	I/O V_{CC} Risettime				15	ns
t_{FVCC}	I/O V_{CC} Falltime				10	ns
t_{RVL}	I/O V_L Risettime				15	ns
t_{FVL}	I/O V_L Falltime				10	ns
$t_{PDVL-VCC}$	Propagation Delay (Driving I/O V_L)				15	ns
$t_{PDVCC-VL}$	Propagation Delay (Driving I/O V_{CC})				15	ns
t_{PPSKEW}	Part-to-Part Skew				5	nS
	Maximum Data Rate		20			Mb/s

$V_L = 2.8 \text{ V}$, $V_{CC} = 1.8 \text{ V}$

t_{RVCC}	I/O V_{CC} Risettime				25	ns
t_{FVCC}	I/O V_{CC} Falltime				10	ns
t_{RVL}	I/O V_L Risettime				20	ns
t_{FVL}	I/O V_L Falltime				15	ns
$t_{PDVL-VCC}$	Propagation Delay (Driving I/O V_L)				15	ns
$t_{PDVCC-VL}$	Propagation Delay (Driving I/O V_{CC})				15	ns
t_{PPSKEW}	Part-to-Part Skew				5	nS
	Maximum Data Rate		20			Mb/s

3. Typical values are for $V_{CC} = +3.3 \text{ V}$, $V_L = +1.8 \text{ V}$ and $T_A = +25^\circ\text{C}$.

4. All units are production tested at $T_A = +25^\circ\text{C}$. Limits over the operating temperature range are guaranteed by design.

NLSX4373

TIMING CHARACTERISTICS – RAIL-TO-RAIL DRIVING CONFIGURATIONS

(I/O test circuit of Figures 2 and 3, $C_{LOAD} = 15 \text{ pF}$, driver output impedance $\leq 50 \Omega$, $R_{LOAD} = 1 \text{ M}\Omega$)

Symbol	Parameter	Test Conditions	-40°C to +85°C (Notes 3 and 4)			Unit
			Min	Typ	Max	
$V_L = 3.6 \text{ V}$, $V_{CC} = 2.5 \text{ V}$						
t_{RVCC}	I/O V_{CC} Risetime				15	ns
t_{FVCC}	I/O V_{CC} Falltime				10	ns
t_{RVL}	I/O V_L Risetime				15	ns
t_{FVL}	I/O V_L Falltime				15	ns
$t_{PDVL-VCC}$	Propagation Delay (Driving I/O V_L)				15	ns
$t_{PDVCC-VL}$	Propagation Delay (Driving I/O V_{CC})				15	ns
t_{PPSKEW}	Part-to-Part Skew				5	nS
	Maximum Data Rate		20			Mb/s

$V_L = 5.5 \text{ V}$, $V_{CC} = 1.5 \text{ V}$

t_{RVCC}	I/O V_{CC} Risetime				30	ns
t_{FVCC}	I/O V_{CC} Falltime				10	ns
t_{RVL}	I/O V_L Risetime				15	ns
t_{FVL}	I/O V_L Falltime				20	ns
$t_{PDVL-VCC}$	Propagation Delay (Driving I/O V_L)				20	ns
$t_{PDVCC-VL}$	Propagation Delay (Driving I/O V_{CC})				20	ns
t_{PPSKEW}	Part-to-Part Skew				5	nS
	Maximum Data Rate		20			Mb/s

3. Typical values are for $V_{CC} = +3.3 \text{ V}$, $V_L = +1.8 \text{ V}$ and $T_A = +25^\circ\text{C}$.

4. All units are production tested at $T_A = +25^\circ\text{C}$. Limits over the operating temperature range are guaranteed by design.

TIMING CHARACTERISTICS – OPEN DRAIN DRIVING CONFIGURATIONS

(I/O test circuit of Figures 4 and 5, $C_{LOAD} = 15 \text{ pF}$, driver output impedance $\leq 50 \Omega$, $R_{LOAD} = 1 \text{ M}\Omega$)

Symbol	Parameter	Test Conditions	-40°C to +85°C (Notes 5 and 6)			Unit
			Min	Typ	Max	
$+1.5 \leq V_L \leq V_{CC} \leq +5.5 \text{ V}$						
t_{RVCC}	I/O V_{CC} Risetime				400	ns
t_{FVCC}	I/O V_{CC} Falltime				50	ns
t_{RVL}	I/O V_L Risetime				400	ns
t_{FVL}	I/O V_L Falltime				60	ns
$t_{PDVL-VCC}$	Propagation Delay (Driving I/O V_L)				1000	ns
$t_{PDVCC-VL}$	Propagation Delay (Driving I/O V_{CC})				1000	ns
t_{PPSKEW}	Part-to-Part Skew				50	nS
MDR	Maximum Data Rate		2			Mb/s

5. Typical values are for $V_{CC} = +3.3 \text{ V}$, $V_L = +1.8 \text{ V}$ and $T_A = +25^\circ\text{C}$.

6. All units are production tested at $T_A = +25^\circ\text{C}$. Limits over the operating temperature range are guaranteed by design.

NLSX4373

TEST SETUPS

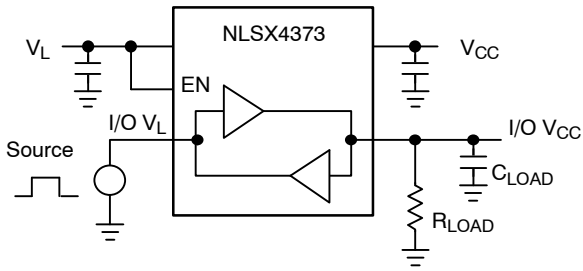

Figure 2. Rail-to-Rail Driving I/O V_L

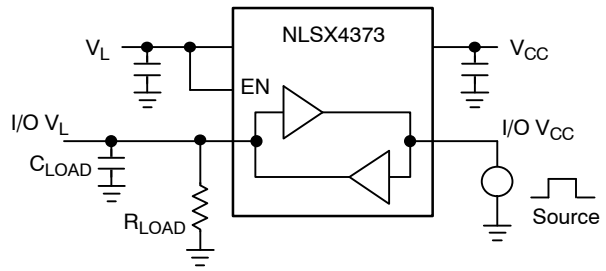

Figure 3. Rail-to-Rail Driving I/O V_{CC}

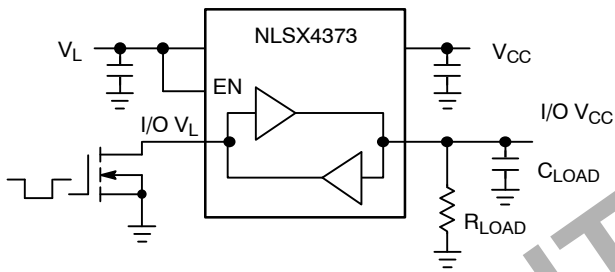

Figure 4. Open-Drain Driving I/O V_L

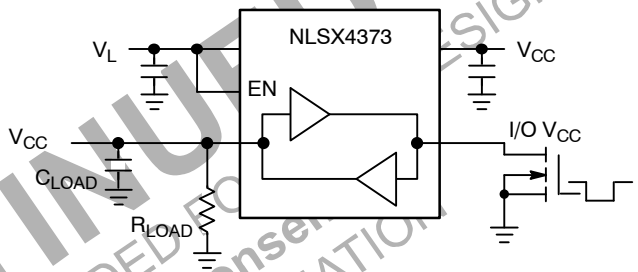

Figure 5. Open-Drain Driving I/O V_{CC}

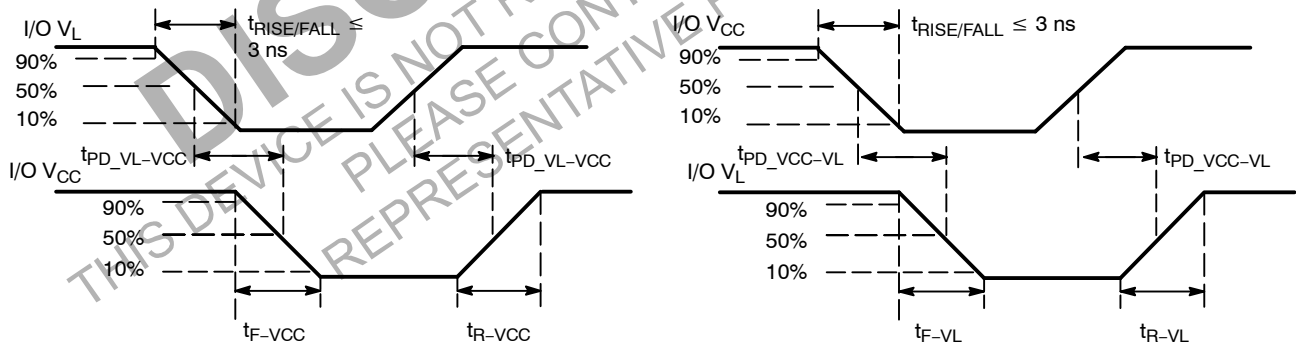
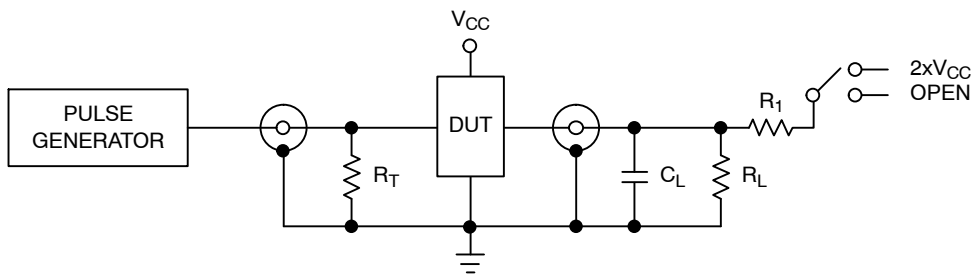

Figure 6. Definition of Timing Specification Parameters

NLSX4373



Test	Switch
t_{PZH}, t_{PHZ}	Open
t_{PZL}, t_{PLZ}	$2 \times V_{CC}$

$C_L = 15 \text{ pF}$ or equivalent (Includes jig and probe capacitance)
 $R_L = R_1 = 50 \text{ k}\Omega$ or equivalent
 $R_T = Z_{OUT}$ of pulse generator (typically 50Ω)

Figure 7. Test Circuit for Enable/Disable Time Measurement

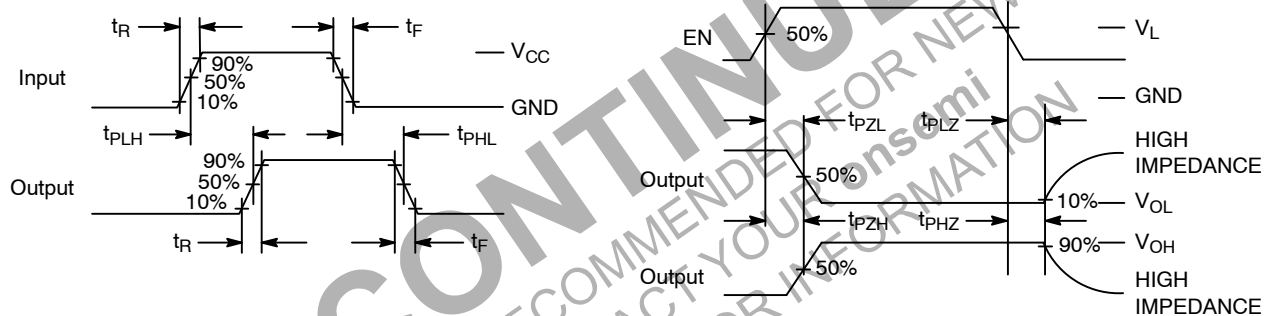

Figure 8. Timing Definitions for Propagation Delays and Enable/Disable Measurement

APPLICATIONS INFORMATION

Level Translator Architecture

The NLSX4373 auto sense translator provides bi-directional voltage level shifting to transfer data in multiple supply voltage systems. This device has two supply voltages, V_L and V_{CC} , which set the logic levels on the input and output sides of the translator. When used to transfer data from the V_L to the V_{CC} ports, input signals referenced to the V_L supply are translated to output signals with a logic level matched to V_{CC} . In a similar manner, the V_{CC} to V_L translation shifts input signals with a logic level compatible to V_{CC} to an output signal matched to V_L .

The NLSX4373 consists of two bi-directional channels that independently determine the direction of the data flow without requiring a directional pin. The one-shot circuits are used to detect the rising or falling input signals. In addition, the one shots decrease the rise and fall time of the output signal for high-to-low and low-to-high transitions.

Each input/output channel has an internal 10 k Ω pull. The magnitude of the pullup resistors can be reduced by connecting external resistors in parallel to the internal 10 k Ω resistors.

Input Driver Requirements

The rise (t_R) and fall (t_F) timing parameters of the open drain outputs depend on the magnitude of the pull-up resistors. In addition, the propagation times (t_{PD}), skew (t_{PSKEW}) and maximum data rate depend on the impedance of the device that is connected to the translator. The timing

parameters listed in the data sheet assume that the output impedance of the drivers connected to the translator is less than 50 k Ω .

Enable Input (EN)

The NLSX4373 has an Enable pin (EN) that provides tri-state operation at the I/O pins. Driving the Enable pin to a low logic level minimizes the power consumption of the device and drives the I/O V_{CC} and I/O V_L pins to a high impedance state. Normal translation operation occurs when the EN pin is equal to a logic high signal. The EN pin is referenced to the V_L supply and has Overvoltage Tolerant (OVT) protection.

Power Supply Guidelines

During normal operation, supply voltage V_L can be greater than, less than or equal to V_{CC} . The sequencing of the power supplies will not damage the device during the power up operation.

For optimal performance, 0.01 μ F to 0.1 μ F decoupling capacitors should be used on the V_L and V_{CC} power supply pins. Ceramic capacitors are a good design choice to filter and bypass any noise signals on the voltage lines to the ground plane of the PCB. The noise immunity will be maximized by placing the capacitors as close as possible to the supply and ground pins, along with minimizing the PCB connection traces.

MECHANICAL CASE OUTLINE

PACKAGE DIMENSIONS

ON Semiconductor®



SCALE 4:1

UDFN8 1.8x1.2, 0.4P
CASE 517AJ-01
ISSUE O

DATE 08 NOV 2006

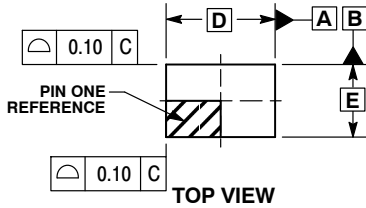

TOP VIEW

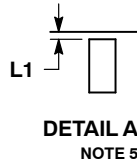

DETAIL A
NOTE 5

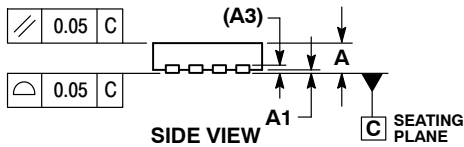

SIDE VIEW

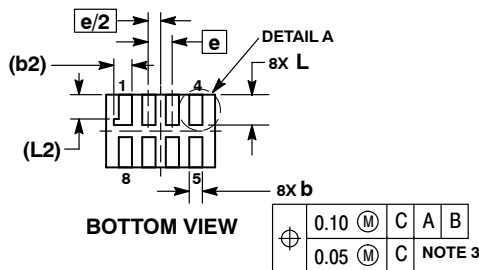

BOTTOM VIEW

⊕	0.10	(M)	C	A	B
	0.05	(M)	C		

NOTE 3

NOTES:

1. DIMENSIONING AND TOLERANCING PER ASME Y14.5M, 1994.
2. CONTROLLING DIMENSION: MILLIMETERS.
3. DIMENSION b APPLIES TO PLATED TERMINAL AND IS MEASURED BETWEEN 0.15 AND 0.30 mm FROM TERMINAL TIP.
4. MOLD FLASH ALLOWED ON TERMINALS ALONG EDGE OF PACKAGE. FLASH MAY NOT EXCEED 0.03 ONTO BOTTOM SURFACE OF TERMINALS.
5. DETAIL A SHOWS OPTIONAL CONSTRUCTION FOR TERMINALS.

DIM	MILLIMETERS	
	MIN	MAX
A	0.45	0.55
A1	0.00	0.05
A3	0.127	REF
b	0.15	0.25
b2	0.30	REF
D	1.80	BSC
E	1.20	BSC
e	0.40	BSC
L	0.45	0.55
L1	0.00	0.03
L2	0.40	REF

GENERIC MARKING DIAGRAM*

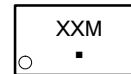

- XX = Specific Device Code
- M = Date Code
- = Pb-Free Package

*This information is generic. Please refer to device data sheet for actual part marking. Pb-Free indicator, "G" or microdot "▪", may or may not be present.

MOUNTING FOOTPRINT
SOLDERMASK DEFINED

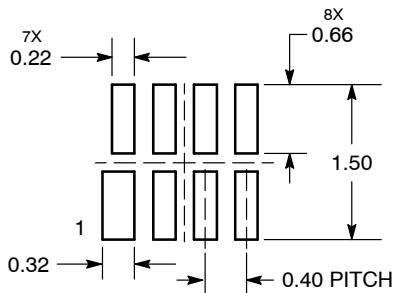

DIMENSIONS: MILLIMETERS

DOCUMENT NUMBER:	98AON23417D	Electronic versions are uncontrolled except when accessed directly from the Document Repository. Printed versions are uncontrolled except when stamped "CONTROLLED COPY" in red.
DESCRIPTION:	UDFN8 1.8X1.2, 0.4P	PAGE 1 OF 1

ON Semiconductor and ON are trademarks of Semiconductor Components Industries, LLC dba ON Semiconductor or its subsidiaries in the United States and/or other countries. ON Semiconductor reserves the right to make changes without further notice to any products herein. ON Semiconductor makes no warranty, representation or guarantee regarding the suitability of its products for any particular purpose, nor does ON Semiconductor assume any liability arising out of the application or use of any product or circuit, and specifically disclaims any and all liability, including without limitation special, consequential or incidental damages. ON Semiconductor does not convey any license under its patent rights nor the rights of others.

MECHANICAL CASE OUTLINE PACKAGE DIMENSIONS



SCALE 1:1

SOIC-8 NB
CASE 751-07
ISSUE AK

DATE 16 FEB 2011

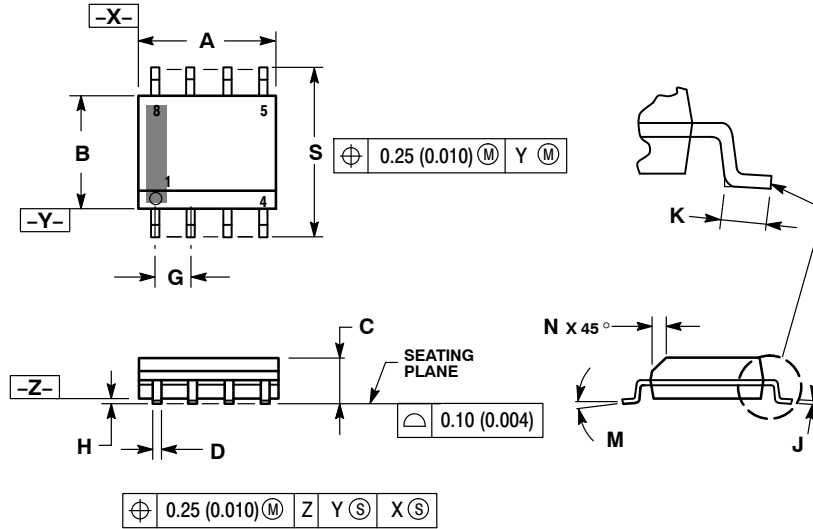

- NOTES:
1. DIMENSIONING AND TOLERANCING PER ANSI Y14.5M, 1982.
 2. CONTROLLING DIMENSION: MILLIMETER.
 3. DIMENSION A AND B DO NOT INCLUDE MOLD PROTRUSION.
 4. MAXIMUM MOLD PROTRUSION 0.15 (0.006) PER SIDE.
 5. DIMENSION D DOES NOT INCLUDE DAMBAR PROTRUSION. ALLOWABLE DAMBAR PROTRUSION SHALL BE 0.127 (0.005) TOTAL IN EXCESS OF THE D DIMENSION AT MAXIMUM MATERIAL CONDITION.
 6. 751-01 THRU 751-06 ARE OBSOLETE. NEW STANDARD IS 751-07.

DIM	MILLIMETERS		INCHES	
	MIN	MAX	MIN	MAX
A	4.80	5.00	0.189	0.197
B	3.80	4.00	0.150	0.157
C	1.35	1.75	0.053	0.069
D	0.33	0.51	0.013	0.020
G	1.27 BSC		0.050 BSC	
H	0.10	0.25	0.004	0.010
J	0.19	0.25	0.007	0.010
K	0.40	1.27	0.016	0.050
M	0°	8°	0°	8°
N	0.25	0.50	0.010	0.020
S	5.80	6.20	0.228	0.244

GENERIC MARKING DIAGRAM*

SOLDERING FOOTPRINT*

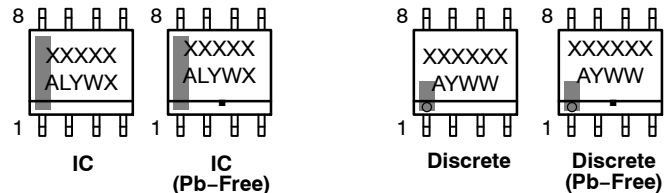
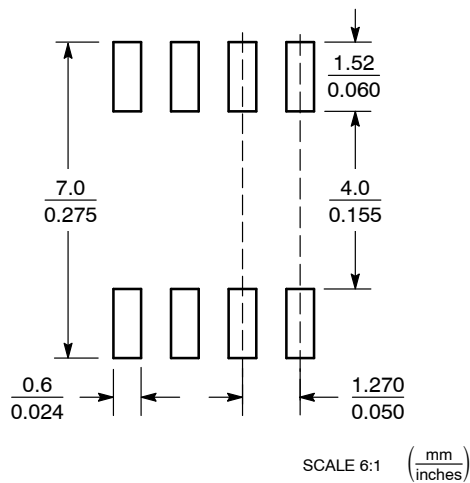

XXXXX = Specific Device Code
A = Assembly Location
L = Wafer Lot
Y = Year
W = Work Week
▪ = Pb-Free Package

XXXXXX = Specific Device Code
A = Assembly Location
Y = Year
WW = Work Week
▪ = Pb-Free Package

*This information is generic. Please refer to device data sheet for actual part marking. Pb-Free indicator, "G" or microdot "▪", may or may not be present. Some products may not follow the Generic Marking.

*For additional information on our Pb-Free strategy and soldering details, please download the ON Semiconductor Soldering and Mounting Techniques Reference Manual, SOLDERRM/D.

STYLES ON PAGE 2

DOCUMENT NUMBER:	98ASB42564B	Electronic versions are uncontrolled except when accessed directly from the Document Repository. Printed versions are uncontrolled except when stamped "CONTROLLED COPY" in red.
DESCRIPTION:	SOIC-8 NB	PAGE 1 OF 2

onsemi and ONsemi are trademarks of Semiconductor Components Industries, LLC dba onsemi or its subsidiaries in the United States and/or other countries. onsemi reserves the right to make changes without further notice to any products herein. onsemi makes no warranty, representation or guarantee regarding the suitability of its products for any particular purpose, nor does onsemi assume any liability arising out of the application or use of any product or circuit, and specifically disclaims any and all liability, including without limitation special, consequential or incidental damages. onsemi does not convey any license under its patent rights nor the rights of others.

SOIC-8 NB
CASE 751-07
ISSUE AK

DATE 16 FEB 2011

- | | | | |
|---|--|--|--|
| <p>STYLE 1:
 PIN 1. EMITTER
 2. COLLECTOR
 3. COLLECTOR
 4. EMITTER
 5. EMITTER
 6. BASE
 7. BASE
 8. EMITTER</p> | <p>STYLE 2:
 PIN 1. COLLECTOR, DIE, #1
 2. COLLECTOR, #1
 3. COLLECTOR, #2
 4. COLLECTOR, #2
 5. BASE, #2
 6. EMITTER, #2
 7. BASE, #1
 8. EMITTER, #1</p> | <p>STYLE 3:
 PIN 1. DRAIN, DIE #1
 2. DRAIN, #1
 3. DRAIN, #2
 4. DRAIN, #2
 5. GATE, #2
 6. SOURCE, #2
 7. GATE, #1
 8. SOURCE, #1</p> | <p>STYLE 4:
 PIN 1. ANODE
 2. ANODE
 3. ANODE
 4. ANODE
 5. ANODE
 6. ANODE
 7. ANODE
 8. COMMON CATHODE</p> |
| <p>STYLE 5:
 PIN 1. DRAIN
 2. DRAIN
 3. DRAIN
 4. DRAIN
 5. GATE
 6. GATE
 7. SOURCE
 8. SOURCE</p> | <p>STYLE 6:
 PIN 1. SOURCE
 2. DRAIN
 3. DRAIN
 4. SOURCE
 5. SOURCE
 6. GATE
 7. GATE
 8. SOURCE</p> | <p>STYLE 7:
 PIN 1. INPUT
 2. EXTERNAL BYPASS
 3. THIRD STAGE SOURCE
 4. GROUND
 5. DRAIN
 6. GATE 3
 7. SECOND STAGE Vd
 8. FIRST STAGE Vd</p> | <p>STYLE 8:
 PIN 1. COLLECTOR, DIE #1
 2. BASE, #1
 3. BASE, #2
 4. COLLECTOR, #2
 5. COLLECTOR, #2
 6. EMITTER, #2
 7. EMITTER, #1
 8. COLLECTOR, #1</p> |
| <p>STYLE 9:
 PIN 1. EMITTER, COMMON
 2. COLLECTOR, DIE #1
 3. COLLECTOR, DIE #2
 4. EMITTER, COMMON
 5. EMITTER, COMMON
 6. BASE, DIE #2
 7. BASE, DIE #1
 8. EMITTER, COMMON</p> | <p>STYLE 10:
 PIN 1. GROUND
 2. BIAS 1
 3. OUTPUT
 4. GROUND
 5. GROUND
 6. BIAS 2
 7. INPUT
 8. GROUND</p> | <p>STYLE 11:
 PIN 1. SOURCE 1
 2. GATE 1
 3. SOURCE 2
 4. GATE 2
 5. DRAIN 2
 6. DRAIN 2
 7. DRAIN 1
 8. DRAIN 1</p> | <p>STYLE 12:
 PIN 1. SOURCE
 2. SOURCE
 3. SOURCE
 4. GATE
 5. DRAIN
 6. DRAIN
 7. DRAIN
 8. DRAIN</p> |
| <p>STYLE 13:
 PIN 1. N.C.
 2. SOURCE
 3. SOURCE
 4. GATE
 5. DRAIN
 6. DRAIN
 7. DRAIN
 8. DRAIN</p> | <p>STYLE 14:
 PIN 1. N-SOURCE
 2. N-GATE
 3. P-SOURCE
 4. P-GATE
 5. P-DRAIN
 6. P-DRAIN
 7. N-DRAIN
 8. N-DRAIN</p> | <p>STYLE 15:
 PIN 1. ANODE 1
 2. ANODE 1
 3. ANODE 1
 4. ANODE 1
 5. CATHODE, COMMON
 6. CATHODE, COMMON
 7. CATHODE, COMMON
 8. CATHODE, COMMON</p> | <p>STYLE 16:
 PIN 1. EMITTER, DIE #1
 2. BASE, DIE #1
 3. EMITTER, DIE #2
 4. BASE, DIE #2
 5. COLLECTOR, DIE #2
 6. COLLECTOR, DIE #2
 7. COLLECTOR, DIE #1
 8. COLLECTOR, DIE #1</p> |
| <p>STYLE 17:
 PIN 1. VCC
 2. V2OUT
 3. V1OUT
 4. TXE
 5. RXE
 6. VEE
 7. GND
 8. ACC</p> | <p>STYLE 18:
 PIN 1. ANODE
 2. ANODE
 3. SOURCE
 4. GATE
 5. DRAIN
 6. DRAIN
 7. CATHODE
 8. CATHODE</p> | <p>STYLE 19:
 PIN 1. SOURCE 1
 2. GATE 1
 3. SOURCE 2
 4. GATE 2
 5. DRAIN 2
 6. MIRROR 2
 7. DRAIN 1
 8. MIRROR 1</p> | <p>STYLE 20:
 PIN 1. SOURCE (N)
 2. GATE (N)
 3. SOURCE (P)
 4. GATE (P)
 5. DRAIN
 6. DRAIN
 7. DRAIN
 8. DRAIN</p> |
| <p>STYLE 21:
 PIN 1. CATHODE 1
 2. CATHODE 2
 3. CATHODE 3
 4. CATHODE 4
 5. CATHODE 5
 6. COMMON ANODE
 7. COMMON ANODE
 8. CATHODE 6</p> | <p>STYLE 22:
 PIN 1. I/O LINE 1
 2. COMMON CATHODE/VCC
 3. COMMON CATHODE/VCC
 4. I/O LINE 3
 5. COMMON ANODE/GND
 6. I/O LINE 4
 7. I/O LINE 5
 8. COMMON ANODE/GND</p> | <p>STYLE 23:
 PIN 1. LINE 1 IN
 2. COMMON ANODE/GND
 3. COMMON ANODE/GND
 4. LINE 2 IN
 5. LINE 2 OUT
 6. COMMON ANODE/GND
 7. COMMON ANODE/GND
 8. LINE 1 OUT</p> | <p>STYLE 24:
 PIN 1. BASE
 2. EMITTER
 3. COLLECTOR/ANODE
 4. COLLECTOR/ANODE
 5. CATHODE
 6. CATHODE
 7. COLLECTOR/ANODE
 8. COLLECTOR/ANODE</p> |
| <p>STYLE 25:
 PIN 1. VIN
 2. N/C
 3. REXT
 4. GND
 5. IOUT
 6. IOUT
 7. IOUT
 8. IOUT</p> | <p>STYLE 26:
 PIN 1. GND
 2. dv/dt
 3. ENABLE
 4. ILIMIT
 5. SOURCE
 6. SOURCE
 7. SOURCE
 8. VCC</p> | <p>STYLE 27:
 PIN 1. ILIMIT
 2. OVLO
 3. UVLO
 4. INPUT+
 5. SOURCE
 6. SOURCE
 7. SOURCE
 8. DRAIN</p> | <p>STYLE 28:
 PIN 1. SW_TO_GND
 2. DASIC_OFF
 3. DASIC_SW_DET
 4. GND
 5. V_MON
 6. VBULK
 7. VBULK
 8. VIN</p> |
| <p>STYLE 29:
 PIN 1. BASE, DIE #1
 2. EMITTER, #1
 3. BASE, #2
 4. EMITTER, #2
 5. COLLECTOR, #2
 6. COLLECTOR, #2
 7. COLLECTOR, #1
 8. COLLECTOR, #1</p> | <p>STYLE 30:
 PIN 1. DRAIN 1
 2. DRAIN 1
 3. GATE 2
 4. SOURCE 2
 5. SOURCE 1/DRAIN 2
 6. SOURCE 1/DRAIN 2
 7. SOURCE 1/DRAIN 2
 8. GATE 1</p> | | |

DOCUMENT NUMBER:	98ASB42564B	Electronic versions are uncontrolled except when accessed directly from the Document Repository. Printed versions are uncontrolled except when stamped "CONTROLLED COPY" in red.
DESCRIPTION:	SOIC-8 NB	PAGE 2 OF 2

onsemi and **ONSEMI** are trademarks of Semiconductor Components Industries, LLC dba **onsemi** or its subsidiaries in the United States and/or other countries. **onsemi** reserves the right to make changes without further notice to any products herein. **onsemi** makes no warranty, representation or guarantee regarding the suitability of its products for any particular purpose, nor does **onsemi** assume any liability arising out of the application or use of any product or circuit, and specifically disclaims any and all liability, including without limitation special, consequential or incidental damages. **onsemi** does not convey any license under its patent rights nor the rights of others.

MECHANICAL CASE OUTLINE

PACKAGE DIMENSIONS

ON Semiconductor®



SCALE 2:1

Micro8 CASE 846A-02 ISSUE K

DATE 16 JUL 2020

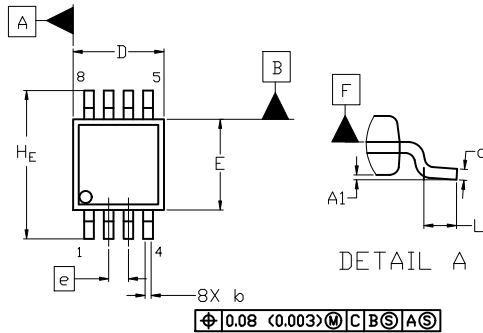

TOP VIEW

NOTE 3

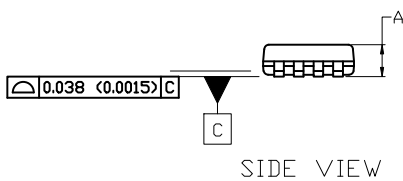

SIDE VIEW

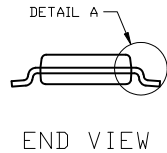

END VIEW

NOTES:

1. DIMENSIONING AND TOLERANCING PER ASME Y14.5M, 2009.
2. CONTROLLING DIMENSION: MILLIMETERS
3. DIMENSION *b* DOES NOT INCLUDE DAMBAR PROTRUSION. ALLOWABLE PROTRUSION SHALL BE 0.10 mm IN EXCESS OF MAXIMUM MATERIAL CONDITION.
4. DIMENSIONS *D* AND *E* DO NOT INCLUDE MOLD FLASH, PROTRUSION OR GATE BURRS. MOLD FLASH, PROTRUSIONS, OR GATE BURRS SHALL NOT EXCEED 0.15 mm PER SIDE. DIMENSION *E* DOES NOT INCLUDE INTERLEAD FLASH OR PROTRUSION. INTERLEAD FLASH OR PROTRUSION SHALL NOT EXCEED 0.25 mm PER SIDE. DIMENSIONS *D* AND *E* ARE DETERMINED AT DATUM *F*.
5. DATUMS *A* AND *B* ARE TO BE DETERMINED AT DATUM *F*.
6. *A1* IS DEFINED AS THE VERTICAL DISTANCE FROM THE SEATING PLANE TO THE LOWEST POINT ON THE PACKAGE BODY.

$\phi 0.08$ (0.003) M C B S A S

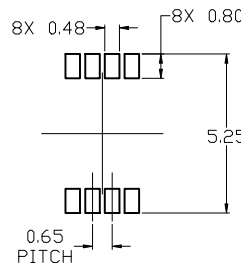

RECOMMENDED MOUNTING FOOTPRINT

DIM	MILLIMETERS		
	MIN.	NOM.	MAX.
A	---	---	1.10
A1	0.05	0.08	0.15
<i>b</i>	0.25	0.33	0.40
<i>c</i>	0.13	0.18	0.23
<i>D</i>	2.90	3.00	3.10
<i>E</i>	2.90	3.00	3.10
<i>e</i>	0.65 BSC		
<i>H_E</i>	4.75	4.90	5.05
<i>L</i>	0.40	0.55	0.70

For additional information on our Pb-Free strategy and soldering details, please download the ON Semiconductor Soldering and Mounting Techniques Reference Manual, SOLDERM/D.

GENERIC MARKING DIAGRAM*

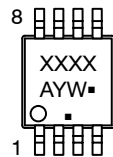

- XXXX = Specific Device Code
- A = Assembly Location
- Y = Year
- W = Work Week
- = Pb-Free Package

(Note: Microdot may be in either location)

*This information is generic. Please refer to device data sheet for actual part marking. Pb-Free indicator, "G" or microdot "▪", may or may not be present. Some products may not follow the Generic Marking.

STYLE 1:

1. SOURCE
2. SOURCE
3. SOURCE
4. GATE
5. DRAIN
6. DRAIN
7. DRAIN
8. DRAIN

STYLE 2:

1. SOURCE 1
2. GATE 1
3. SOURCE 2
4. GATE 2
5. DRAIN 2
6. DRAIN 2
7. DRAIN 1
8. DRAIN 1

STYLE 3:

1. N-SOURCE
2. N-GATE
3. P-SOURCE
4. P-GATE
5. P-DRAIN
6. P-DRAIN
7. N-DRAIN
8. N-DRAIN

DOCUMENT NUMBER:	98ASB14087C	Electronic versions are uncontrolled except when accessed directly from the Document Repository. Printed versions are uncontrolled except when stamped "CONTROLLED COPY" in red.
DESCRIPTION:	MICRO8	PAGE 1 OF 1

ON Semiconductor and ON are trademarks of Semiconductor Components Industries, LLC dba ON Semiconductor or its subsidiaries in the United States and/or other countries. ON Semiconductor reserves the right to make changes without further notice to any products herein. ON Semiconductor makes no warranty, representation or guarantee regarding the suitability of its products for any particular purpose, nor does ON Semiconductor assume any liability arising out of the application or use of any product or circuit, and specifically disclaims any and all liability, including without limitation special, consequential or incidental damages. ON Semiconductor does not convey any license under its patent rights nor the rights of others.

onsemi, **Onsemi**, and other names, marks, and brands are registered and/or common law trademarks of Semiconductor Components Industries, LLC dba "**onsemi**" or its affiliates and/or subsidiaries in the United States and/or other countries. **onsemi** owns the rights to a number of patents, trademarks, copyrights, trade secrets, and other intellectual property. A listing of **onsemi**'s product/patent coverage may be accessed at www.onsemi.com/site/pdf/Patent-Marking.pdf. **onsemi** reserves the right to make changes at any time to any products or information herein, without notice. The information herein is provided "as-is" and **onsemi** makes no warranty, representation or guarantee regarding the accuracy of the information, product features, availability, functionality, or suitability of its products for any particular purpose, nor does **onsemi** assume any liability arising out of the application or use of any product or circuit, and specifically disclaims any and all liability, including without limitation special, consequential or incidental damages. Buyer is responsible for its products and applications using **onsemi** products, including compliance with all laws, regulations and safety requirements or standards, regardless of any support or applications information provided by **onsemi**. "Typical" parameters which may be provided in **onsemi** data sheets and/or specifications can and do vary in different applications and actual performance may vary over time. All operating parameters, including "Typicals" must be validated for each customer application by customer's technical experts. **onsemi** does not convey any license under any of its intellectual property rights nor the rights of others. **onsemi** products are not designed, intended, or authorized for use as a critical component in life support systems or any FDA Class 3 medical devices or medical devices with a same or similar classification in a foreign jurisdiction or any devices intended for implantation in the human body. Should Buyer purchase or use **onsemi** products for any such unintended or unauthorized application, Buyer shall indemnify and hold **onsemi** and its officers, employees, subsidiaries, affiliates, and distributors harmless against all claims, costs, damages, and expenses, and reasonable attorney fees arising out of, directly or indirectly, any claim of personal injury or death associated with such unintended or unauthorized use, even if such claim alleges that **onsemi** was negligent regarding the design or manufacture of the part. **onsemi** is an Equal Opportunity/Affirmative Action Employer. This literature is subject to all applicable copyright laws and is not for resale in any manner.

ADDITIONAL INFORMATION

TECHNICAL PUBLICATIONS:

Technical Library: www.onsemi.com/design/resources/technical-documentation
onsemi Website: www.onsemi.com

ONLINE SUPPORT: www.onsemi.com/support

For additional information, please contact your local Sales Representative at www.onsemi.com/support/sales

Looking for pricing, stock, or lifecycle information?

Click below to explore more details on WIN SOURCE:

 [View NLSX4373DR2G on WIN SOURCE](#)

 [ON Semiconductor](#) Information

Optimize Your Supply Chain with WIN SOURCE Solutions

-  Global Sourcing Solution
-  Obsolete Management
-  Cost Control Management
-  Shortage Management
-  Alternative Solution
-  Excess Inventory Management