



**THE DATASHEET OF  
CCK-0512DF**



## DC to DC Converters

Conformity to RoHS Directive

# Insulation Type, 1.5 to 10W Output, 5-year Warranty Period, UL/C-UL Certified(except CCP Type)

## CC Series

### FEATURES

- 5-year warranty period.
- With input protection element.
- With output variable terminal (except CCP24□□).
- Input-output floating.
- Shield type of 5-sided metal case.
- External component not required.
- With overcurrent protection function.
- With input remote control (CCN type).
- Long life without electrolytic capacitor.
- Input voltage alarm function incorporated (CCP-24□□ type).
- It is a product conforming to RoHS directive.



### PART NUMBERS AND RATINGS

#### CCK TYPE

Output current	Input voltage	Output voltage						
		3.3V	5V	12V <sup>*1</sup>	15V <sup>*1</sup>	±12V <sup>*2</sup>	±15V <sup>*2</sup>	24V <sup>*3</sup>
1.5W	5V	CCK-0503SF	CCK-0505SF	CCK-0512SF	CCK-0512SF	CCK-0512DF	CCK-0512DF	CCK-0512DF
	12V	CCK-1203SF	CCK-1205SF	CCK-1212SF	CCK-1212SF	CCK-1212DF	CCK-1212DF	CCK-1212DF
	24V	CCK-2403SF	CCK-2405SF	CCK-2412SF	CCK-2412SF	CCK-2412DF	CCK-2412DF	CCK-2412DF
	48V	CCK-4803SF	CCK-4805SF	CCK-4812SF	CCK-4812SF	CCK-4812DF	CCK-4812DF	CCK-4812DF

#### CCM TYPE

Output current	Input voltage	Output voltage						
		3.3V	5V	12V <sup>*1</sup>	15V <sup>*1</sup>	±12V <sup>*2</sup>	±15V <sup>*2</sup>	24V <sup>*3</sup>
3W	5V	CCM-0503SF	CCM-0505SF	CCM-0512SF	CCM-0512SF	CCM-0512DF	CCM-0512DF	CCM-0512DF
	12V	CCM-1203SF	CCM-1205SF	CCM-1212SF	CCM-1212SF	CCM-1212DF	CCM-1212DF	CCM-1212DF
	24V	CCM-2403SF	CCM-2405SF	CCM-2412SF	CCM-2412SF	CCM-2412DF	CCM-2412DF	CCM-2412DF
	48V	CCM-4803SF	CCM-4805SF	CCM-4812SF	CCM-4812SF	CCM-4812DF	CCM-4812DF	CCM-4812DF

#### CCN TYPE

Output current	Input voltage	Output voltage						
		3.3V	5V	12V <sup>*1</sup>	15V <sup>*1</sup>	±12V <sup>*2</sup>	±15V <sup>*2</sup>	24V <sup>*3</sup>
6W	5V	CCN-0503SF	CCN-0505SF	CCN-0512SF	CCN-0512SF	CCN-0512DF	CCN-0512DF	CCN-0512DF
	12V	CCN-1203SF	CCN-1205SF	CCN-1212SF	CCN-1212SF	CCN-1212DF	CCN-1212DF	CCN-1212DF
	24V	CCN-2403SF	CCN-2405SF	CCN-2412SF	CCN-2412SF	CCN-2412DF	CCN-2412DF	CCN-2412DF
	48V	CCN-4803SF	CCN-4805SF	CCN-4812SF	CCN-4812SF	CCN-4812DF	CCN-4812DF	CCN-4812DF

#### CCP TYPE

Output current	Input voltage	Output voltage		
		3.3V	5V	12V
10W	24V	CCP-2403SF	CCP-2405SF	CCP-2412SF

\*1 The same product can be used for the 12V output and the 15V output by using the Vset terminal.

\*2 The same product can be used for the ±12V output and the ±15V output by using the Vset terminal.

\*3 The 24V output is used as a single output with the COM. terminal of the ±12V output product open.

• Conformity to RoHS Directive: This means that, in conformity with EU Directive 2002/95/EC, lead, cadmium, mercury, hexavalent chromium, and specific bromine-based flame retardants, PBB and PBDE, have not been used, except for exempted applications.

• All specifications are subject to change without notice.

## CCK Type

### SPECIFICATIONS AND STANDARDS

Part No.		CCK-0503SF	CCK-0505SF	CCK-0512SF	CCK-0512DF	CCK-1203SF	CCK-1205SF	CCK-1212SF	CCK-1212DF
Maximum output power	W	1.3	1.5	1.5	1.5	1.3	1.5	1.5	1.5
Input conditions									
Input voltage E <sub>dc</sub>	V	4.5 to 9(5typ.)				9 to 18(12typ.)			
Efficiency* <sup>1</sup>	%	66typ.	68typ.	70typ.	68typ.	70typ.	73typ.	75typ.	73typ.
Output characteristics									
Output voltage E <sub>dc</sub>	V	3.3	5	12	±12	3.3	5	12	±12
Output voltage 2* <sup>2</sup> E <sub>dc</sub>	V	3.67	6	15	±15	3.67	6	15	±15
Voltage variable range E <sub>dc</sub>	V	2.84 to 3.67	4.3 to 6	12 to 15	12 to 15	2.84 to 3.67	4.3 to 6	12 to 15	12 to 15
Maximum output current	mA	400	300	125	60	400	300	125	60
Maximum output current 2* <sup>2</sup>	mA	350	250	100	50	350	250	100	50
Output voltage total variation	%	±5max.	±5max.	±5max.	±5max.	±5max.	±5max.	±5max.	±5max.
Voltage stability	Input variation	mV	20	20	30	40	20	20	30
	Load variation* <sup>3</sup>	mV	40	40	100	600	40	40	100
	Temperature variation	mV	50	50	100	150	50	50	100
Ripple noise E <sub>p</sub> -p* <sup>4</sup>	mV	40typ.	40typ.	30typ.	30typ.	40typ.	40typ.	30typ.	30typ.
	mV	120max.	120max.	120max.	120max.	120max.	120max.	120max.	120max.

Part No.		CCK-2403SF	CCK-2405SF	CCK-2412SF	CCK-2412DF	CCK-4803SF	CCK-4805SF	CCK-4812SF	CCK-4812DF
Maximum output power	W	1.3	1.5	1.5	1.5	1.3	1.5	1.5	1.5
Input conditions									
Input voltage E <sub>dc</sub>	V	18 to 36(24typ.)				36 to 72(48typ.)			
Efficiency* <sup>1</sup>	%	70typ.	75typ.	75typ.	75typ.	70typ.	75typ.	75typ.	75typ.
Output characteristics									
Output voltage E <sub>dc</sub>	V	3.3	5	12	±12	3.3	5	12	±12
Output voltage 2* <sup>2</sup> E <sub>dc</sub>	V	3.67	6	15	±15	3.67	6	15	±15
Voltage variable range E <sub>dc</sub>	V	2.84 to 3.67	4.3 to 6	12 to 15	12 to 15	2.84 to 3.67	4.3 to 6	12 to 15	12 to 15
Maximum output current	mA	400	300	125	60	400	300	125	60
Maximum output current 2* <sup>2</sup>	mA	350	250	100	50	350	250	100	50
Output voltage total variation	%	±5max.	±5max.	±5max.	±5max.	±5max.	±5max.	±5max.	±5max.
Voltage stability	Input variation	mV	20	20	30	40	20	20	30
	Load variation* <sup>3</sup>	mV	40	40	100	600	40	40	100
	Temperature variation	mV	50	50	100	150	50	50	100
Ripple noise E <sub>p</sub> -p* <sup>4</sup>	mV	40typ.	40typ.	30typ.	30typ.	40typ.	40typ.	30typ.	30typ.
	mV	120max.	120max.	120max.	120max.	120max.	120max.	120max.	120max.

\*<sup>1</sup> Typical input voltage, maximum output current

\*<sup>2</sup> V<sub>set</sub> and -V<sub>out</sub> are shorted.

\*<sup>3</sup> Load variation condition of 2-output product: Balance load

\*<sup>4</sup> Measurement bandwidth: 50MHz

- The 2-output product can be used as a single output of 24V to 30V with the COM. terminal open.
- Refer to the description of the application for information about the voltage adjustment method or the like.

### OUTPUT POWER - AMBIENT TEMPERATURE(DERATING)

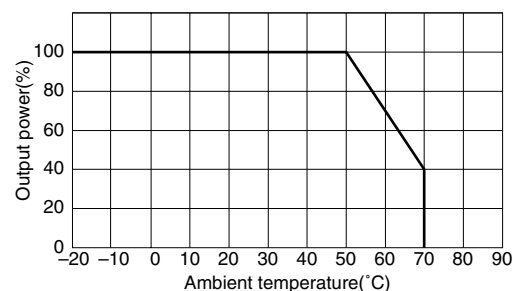

- If the operating temperature range is determined based on the case surface temperature, it should be 90°C or lower independently of a load rate.

### PRECAUTIONS

- Parallel operation to increase output current is not possible.
- Since the converter is entirely shielded by a metal case, care should be taken to isolate the case from the surrounding components and wiring pattern.

# CCK Type

## SHAPES AND DIMENSIONS

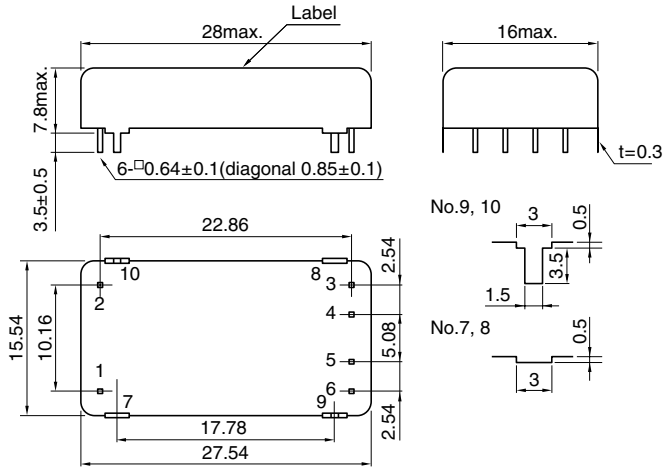

Weight: 6g

Dimensions in mm  
Tolerance: ±0.3

## RECOMMENDED PWB HOLE SIZE, LOCATION [TOP VIEW]

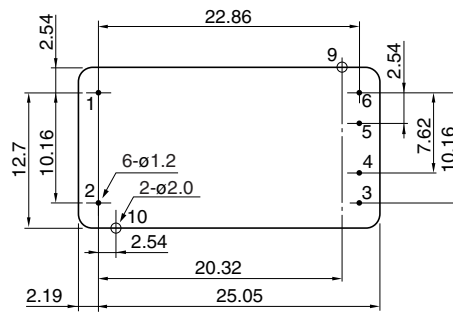

## CIRCUIT DIAGRAMS

### SINGLE OUTPUT TYPE

#### CCK-□□□□ SF SERIES

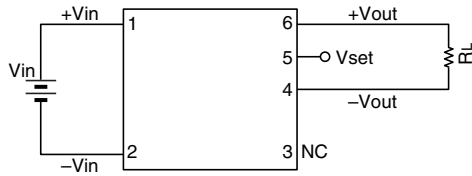

#### TERMINAL PIN CONFIGURATION

No.1	+Vin
No.2	-Vin
No.3	NC
No.4	-Vout
No.5	Vset
No.6	+Vout

### 2-OUTPUT TYPE

#### CCK-□□□□ DF SERIES

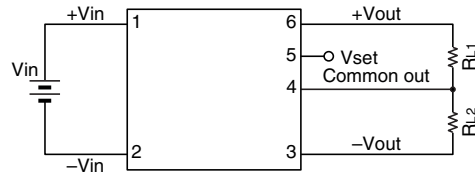

#### TERMINAL PIN CONFIGURATION

No.1	+Vin
No.2	-Vin
No.3	-Vout
No.4	Common out
No.5	Vset
No.6	+Vout

Oscillating method: Astable frequency method

Oscillating frequency: Approx. 200kHz[100% load] to approx. 1200kHz[no load]

MTTF: 500Fit[2000000h, 100% load]

## COMMON SPECIFICATIONS

Overcurrent protection	Yes
Remote ON-OFF	No
Temperature range	Operating(°C) -20 to +70[Derating is necessary when operating environment temperature exceed 50°C.] Storage(°C) -40 to +85
Humidity range	Operating(%)RH 20 to 95[Maximum wet-bulb temperature: 38°C, without dewing] Storage(%)RH 20 to 95[Maximum wet-bulb temperature: 38°C, without dewing]
Amplitude	10 to 55Hz, all amplitude 1.52mm, sweep time 15min.[3 directions of X, Y, Z, each 2h]
Vibration	980m/s <sup>2</sup> (100G) 6ms[6 directions, each 3 times]
Withstand voltage Eac	Input to output, input to case, output to case: 500V, 1min.
Insulation resistance	Input to output, input to case, output to case: 50MΩ min.[DC.500V]
Safety standards	UL60950, CSA60950(C-UL) certified
External dimensions	28×7.8×16mm[W×H×D]
Weight	6g

• All specifications are subject to change without notice.

## CCM Type

### SPECIFICATIONS AND STANDARDS

Part No.		CCM-0503SF	CCM-0505SF	CCM-0512SF	CCM-0512DF	CCM-1203SF	CCM-1205SF	CCM-1212SF	CCM-1212DF
Maximum output power	W	2	3	3	3	2	3	3	3
Input conditions									
Input voltage E <sub>dc</sub>	V	4.5 to 9(5typ.)				9 to 18(12typ.)			
Efficiency* <sup>1</sup>	%	65typ.	70typ.	72typ.	72typ.	70typ.	75typ.	77typ.	77typ.
Output characteristics									
Output voltage E <sub>dc</sub>	V	3.3	5	12	±12	3.3	5	12	±12
Output voltage 2* <sup>2</sup> E <sub>dc</sub>	V	3.67	6	15	±15	3.67	6	15	±15
Voltage variable range E <sub>dc</sub>	V	2.84 to 3.67	4.3 to 6	12 to 15	12 to 15	2.84 to 3.67	4.3 to 6	12 to 15	12 to 15
Maximum output current	mA	600	600	250	125	600	600	250	125
Maximum output current 2* <sup>2</sup>	mA	540	500	200	100	540	500	200	100
Output voltage total variation	%	±5max.	±5max.	±5max.	±5max.	±5max.	±5max.	±5max.	±5max.
Voltage stability	Input variation	mV	20	20	30	40	20	20	30
	Load variation* <sup>3</sup>	mV	40	40	100	600	40	40	100
	Temperature variation	mV	50	50	100	150	50	50	100
Ripple noise E <sub>p</sub> -p* <sup>4</sup>	mV	40typ.	40typ.	30typ.	30typ.	40typ.	40typ.	30typ.	30typ.
	mV	120max.	120max.	120max.	120max.	120max.	120max.	120max.	120max.

Part No.		CCM-2403SF	CCM-2405SF	CCM-2412SF	CCM-2412DF	CCM-4803SF	CCM-4805SF	CCM-4812SF	CCM-4812DF
Maximum output power	W	2	3	3	3	2	3	3	3
Input conditions									
Input voltage E <sub>dc</sub>	V	18 to 36(24typ.)				36 to 72(48typ.)			
Efficiency* <sup>1</sup>	%	70typ.	75typ.	78typ.	78typ.	70typ.	75typ.	78typ.	78typ.
Output characteristics									
Output voltage E <sub>dc</sub>	V	3.3	5	12	±12	3.3	5	12	±12
Output voltage 2* <sup>2</sup> E <sub>dc</sub>	V	3.67	6	15	±15	3.67	6	15	±15
Voltage variable range E <sub>dc</sub>	V	2.84 to 3.67	4.3 to 6	12 to 15	12 to 15	2.84 to 3.67	4.3 to 6	12 to 15	12 to 15
Maximum output current	mA	600	600	250	125	600	600	250	125
Maximum output current 2* <sup>2</sup>	mA	540	500	200	100	540	500	200	100
Output voltage total variation	%	±5max.	±5max.	±5max.	±5max.	±5max.	±5max.	±5max.	±5max.
Voltage stability	Input variation	mV	20	20	30	40	20	20	30
	Load variation* <sup>3</sup>	mV	40	40	100	600	40	40	100
	Temperature variation	mV	50	50	100	150	50	50	100
Ripple noise E <sub>p</sub> -p* <sup>4</sup>	mV	40typ.	40typ.	30typ.	30typ.	40typ.	40typ.	30typ.	30typ.
	mV	120max.	120max.	120max.	120max.	120max.	120max.	120max.	120max.

\*<sup>1</sup> Typical input voltage, maximum output current

\*<sup>2</sup> V<sub>set</sub> and -V<sub>out</sub> are shorted.

\*<sup>3</sup> Load variation condition of 2-output product: Balance load

\*<sup>4</sup> Measurement bandwidth: 50MHz

- The 2-output product can be used as a single output of 24V to 30V with the COM. terminal open.
- Refer to the description of the application for information about the voltage adjustment method or the like.

### OUTPUT POWER - AMBIENT TEMPERATURE(DERATING)

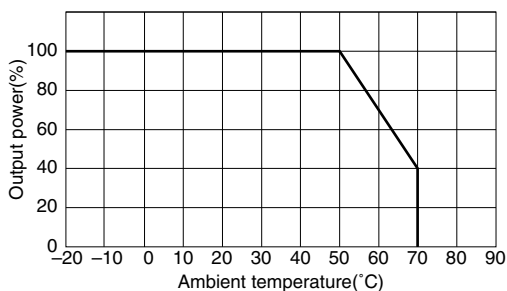

- If the operating temperature range is determined based on the case surface temperature, it should be 90°C or lower independently of a load rate.

### PRECAUTIONS

- Parallel operation to increase output current is not possible.
- Since the converter is entirely shielded by a metal case, care should be taken to isolate the case from the surrounding components and wiring pattern.

## CCM Type

### SHAPES AND DIMENSIONS

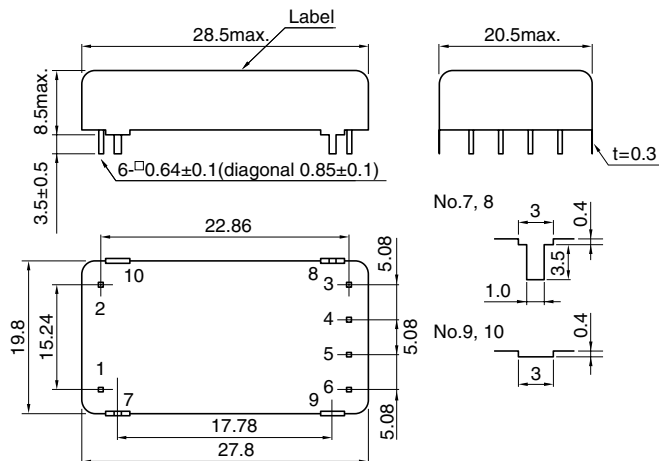

Weight:10g

Dimensions in mm  
Tolerance: ±0.3

### RECOMMENDED PWB HOLE SIZE, LOCATION [TOP VIEW]

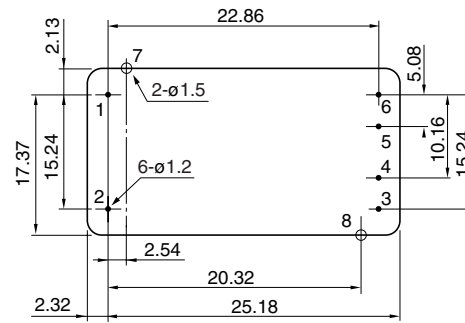

### CIRCUIT DIAGRAMS

#### SINGLE OUTPUT TYPE

##### CCM-□□□□ SF SERIES



#### TERMINAL PIN CONFIGURATION

No.1	+Vin
No.2	-Vin
No.3	NC
No.4	-Vout
No.5	Vset
No.6	+Vout

#### 2-OUTPUT TYPE

##### CCM-□□□□ DF SERIES

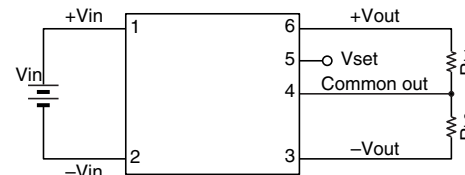

#### TERMINAL PIN CONFIGURATION

No.1	+Vin
No.2	-Vin
No.3	-Vout
No.4	Common out
No.5	Vset
No.6	+Vout

Oscillating method: Astable frequency method

Oscillating frequency: Approx. 200kHz[100% load] to approx. 1200kHz[no load]

MTTF: 500Fit[2000000h, 100% load]

### COMMON SPECIFICATIONS

Oscillating method	Astable frequency method
Oscillating frequency	Approx. 200kHz[100% load] to approx. 1200kHz[no load]
MTTF	500Fit[2000000h, 100% load]
Overcurrent protection	Yes
Remote ON-OFF	No
Temperature range	Operating(°C) -20 to +70[Derating is necessary when operating environment temperature exceed 50°C.] Storage(°C) -40 to +85
Humidity range	Operating(%)RH 20 to 95[Maximum wet-bulb temperature: 38°C, without dewing] Storage(%)RH 20 to 95[Maximum wet-bulb temperature: 38°C, without dewing]
Amplitude	10 to 55Hz, all amplitude 1.52mm, sweep time 15min.[3 directions of X, Y, Z, each 2h]
Vibration	980m/s <sup>2</sup> (100G) 6ms[6 directions, each 3 times]
Withstand voltage Eac	Input to output, input to case, output to case: 500V, 1min.
Insulation resistance	Input to output, input to case, output to case: 50MΩ min.[DC.500V]
Safety standards	UL60950, CSA60950(C-UL) certified
External dimensions	28.5×8.5×20.5mm[W×H×D]
Weight	10g

## CCN Type

### SPECIFICATIONS AND STANDARDS

Part No.		CCN-0503SF	CCN-0505SF	CCN-0512SF	CCN-0512DF	CCN-1203SF	CCN-1205SF	CCN-1212SF	CCN-1212DF
Maximum output power	W	4	5	6	6	5	6	6	6
Input conditions									
Input voltage E <sub>dc</sub>	V	4.5 to 9(5typ.)				9 to 18(12typ.)			
Efficiency* <sup>1</sup>	%	70typ.	74typ.	78typ.	76typ.	73typ.	80typ.	85typ.	85typ.
Output characteristics									
Output voltage E <sub>dc</sub>	V	3.3	5	12	±12	3.3	5	12	±12
Output voltage 2 <sup>*2</sup> E <sub>dc</sub>	V	3.67	6	15	±15	3.67	6	15	±15
Voltage variable range E <sub>dc</sub>	V	2.84 to 3.67	4.3 to 6	12 to 15	12 to 15	2.84 to 3.67	4.3 to 6	12 to 15	12 to 15
Maximum output current	mA	1200	1000	500	250	1500	1200	500	250
Maximum output current 2 <sup>*2</sup>	mA	1000	800	400	200	1300	1000	400	200
Output voltage total variation	%	±5max.	±5max.	±5max.	±5max.	±5max.	±5max.	±5max.	±5max.
Voltage stability	Input variation	mV	20	20	30	40	20	20	30
	Load variation* <sup>3</sup>	mV	40	40	100	600	40	40	100
	Temperature variation	mV	50	50	100	150	50	50	100
Ripple noise E <sub>p</sub> -p <sup>*4</sup>	mV	60typ.	40typ.	30typ.	30typ.	60typ.	40typ.	30typ.	30typ.
	mV	120max.	120max.	120max.	120max.	120max.	120max.	120max.	120max.

Part No.		CCN-2403SF	CCN-2405SF	CCN-2412SF	CCN-2412DF	CCN-4803SF	CCN-4805SF	CCN-4812SF	CCN-4812DF
Maximum output power	W	5	6	6	6	5	6	6	6
Input conditions									
Input voltage E <sub>dc</sub>	V	18 to 36(24typ.)				36 to 72(48typ.)			
Efficiency* <sup>1</sup>	%	77typ.	82typ.	85typ.	85typ.	77typ.	80typ.	85typ.	85typ.
Output characteristics									
Output voltage E <sub>dc</sub>	V	3.3	5	12	±12	3.3	5	12	±12
Output voltage 2 <sup>*2</sup> E <sub>dc</sub>	V	3.67	6	15	±15	3.67	6	15	±15
Voltage variable range E <sub>dc</sub>	V	2.84 to 3.67	4.3 to 6	12 to 15	12 to 15	2.84 to 3.67	4.3 to 6	12 to 15	12 to 15
Maximum output current	mA	1500	1200	500	250	1500	1200	500	250
Maximum output current 2 <sup>*2</sup>	mA	1300	1000	400	200	1300	1000	400	200
Output voltage total variation	%	±5max.	±5max.	±5max.	±5max.	±5max.	±5max.	±5max.	±5max.
Voltage stability	Input variation	mV	20	20	30	40	20	20	30
	Load variation* <sup>3</sup>	mV	40	40	100	600	40	40	100
	Temperature variation	mV	50	50	100	150	50	50	100
Ripple noise E <sub>p</sub> -p <sup>*4</sup>	mV	60typ.	40typ.	30typ.	30typ.	60typ.	40typ.	30typ.	30typ.
	mV	120max.	120max.	120max.	120max.	120max.	120max.	120max.	120max.

\*1 Typical input voltage, maximum output current

\*2 V<sub>set</sub> and -V<sub>out</sub> are shorted.

\*3 Load variation condition of 2-output product: Balance load

\*4 Measurement bandwidth: 50MHz

- The 2-output product can be used as a single output of 24V to 30V with the COM. terminal open.
- Refer to the description of the application for information about the voltage adjustment method or the like.

### OUTPUT POWER - AMBIENT TEMPERATURE(DERATING)

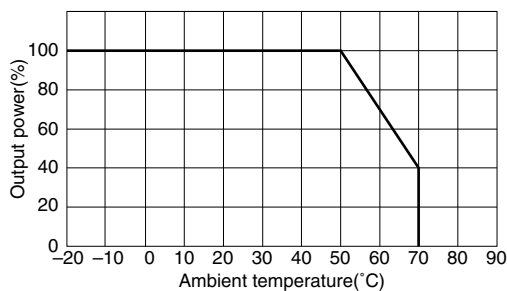

- If the operating temperature range is determined based on the case surface temperature, it should be 90°C or lower independently of a load rate.

### PRECAUTIONS

- Parallel operation to increase output current is not possible.
- Since the converter is entirely shielded by a metal case, care should be taken to isolate the case from the surrounding components and wiring pattern.

## CCN Type

### SHAPES AND DIMENSIONS

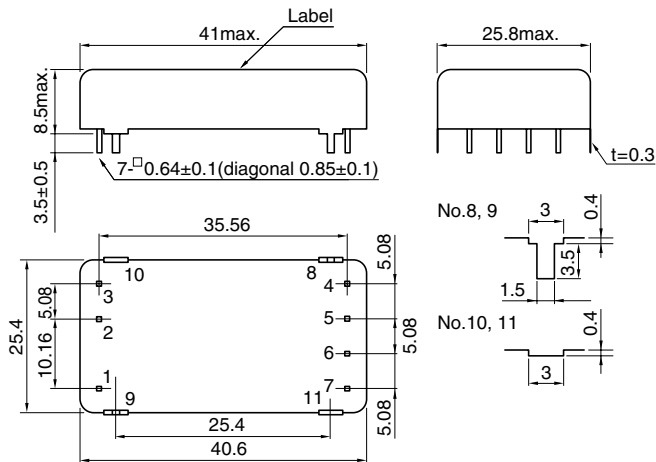

Weight:17g

Dimensions in mm  
Tolerance :±0.3

### RECOMMENDED PWB HOLE SIZE, LOCATION[TOP VIEW]

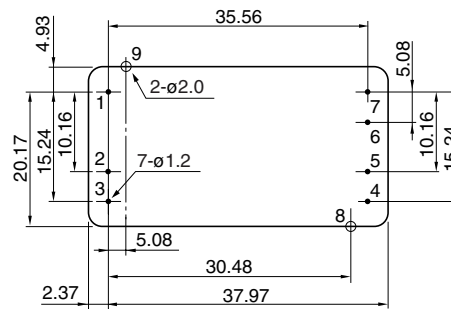

### CIRCUIT DIAGRAMS

#### SINGLE OUTPUT TYPE

##### CCN-□□□□ SF SERIES

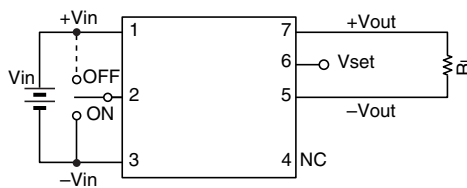

#### TERMINAL PIN CONFIGURATION

No.1	+Vin
No.2	Vctl
No.3	-Vin
No.4	NC
No.5	-Vout
No.6	Vset
No.7	+Vout

#### 2-OUTPUT TYPE

##### CCN-□□□□ DF SERIES

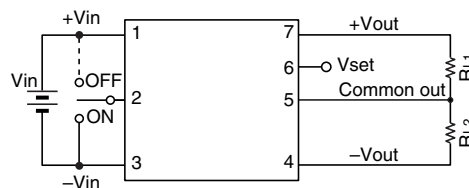

#### TERMINAL PIN CONFIGURATION

No.1	+Vin
No.2	Vctl
No.3	-Vin
No.4	-Vout
No.5	Common out
No.6	Vset
No.7	+Vout

Oscillating method: Astable frequency method

Oscillating frequency: Approx. 150kHz[100% load] to approx. 1000kHz[no load]

MTTF: 650Fit[1500000h, 100% load]

### COMMON SPECIFICATIONS

Overcurrent protection	Yes
Remote ON-OFF	Yes
Temperature range	Operating(°C) -20 to +70[Derating is necessary when operating environment temperature exceed 50°C.] Storage(°C) -40 to +85
Humidity range	Operating(%)RH 20 to 95[Maximum wet-bulb temperature: 38°C, without dewing] Storage(%)RH 20 to 95[Maximum wet-bulb temperature: 38°C, without dewing]
Amplitude	10 to 55Hz, all amplitude 1.52mm, sweep time 15min.[3 directions of X, Y, Z, each 2h]
Vibration	980m/s <sup>2</sup> (100G) 6ms[6 directions, each 3 times]
Withstand voltage Eac	Input to output, input to case, output to case: 500V, 1min.
Insulation resistance	Input to output, input to case, output to case: 50MΩ min.[DC.500V]
Safety standards	UL60950, CSA60950(C-UL) certified
External dimensions	41×8.5×25.8mm[W×H×D]
Weight	17g

## CCP Type

### SPECIFICATIONS AND STANDARDS

Part No.		CCP-2403SF	CCP-2405SF	CCP-2412SF
Maximum output power		W	7.59	10
10.2				
Input conditions				
Input voltage E <sub>dc</sub>		V	18 to 36(24typ.)	18 to 36(24typ.)
Efficiency		%	80typ.	83typ.
85typ.				
Output characteristics				
Output voltage E <sub>dc</sub>		V	3.3	5
12				
Maximum output current		mA	2300	2000
850				
Output voltage total variation*1		%	±5max.	±5max.
±5max.				
Voltage stability	Input variation	mV	20	20
	Load variation	mV	40	50
	Temperature variation	mV	50	100
150				
Ripple noise E <sub>p</sub> -p <sup>3</sup>	mV	60typ.	80typ.	100typ.
	mV	120max.	120max.	150max.

\*1 Output voltage includes input variation, load variation, and temperature variation.

\*2 Measurement bandwidth: 50MHz

\*3 Typical input voltage, maximum output current

\*4 Overcurrent protection function is automatic reset type.

### OUTPUT POWER - AMBIENT TEMPERATURE(DERATING)

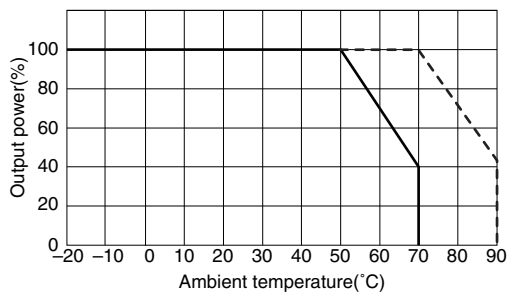

- If the case temperature is used for the derating, apply the range indicated by the dashed line.

### PRECAUTIONS

- Parallel operation to increase output current is not possible.
- Since the converter is entirely shielded by a metal case, care should be taken to isolate the case from the surrounding components and wiring pattern.

### CONNECTIONS

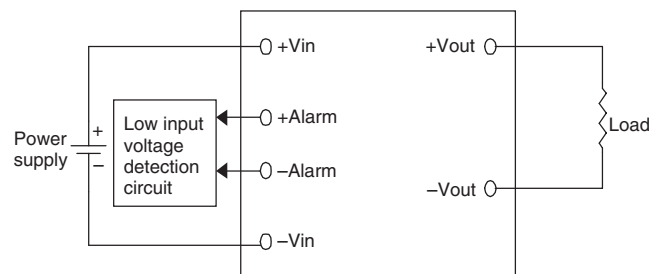

The input voltage detection output terminal ( $\pm$ Alarm) is a transistor output of a photo-coupler and it is insulated at the both input and output sides.

### LOW INPUT VOLTAGE DETECTION CIRCUIT

The following circuit configuration is recommended for the low input voltage detection circuit.

In a rise of the power supply, the +Alarm terminal is at the low level when the input voltage is in a range of 18 to 19V.

In a fall of the power supply, the +Alarm terminal is at the high level when the input voltage is in a range of 17 to 18V.

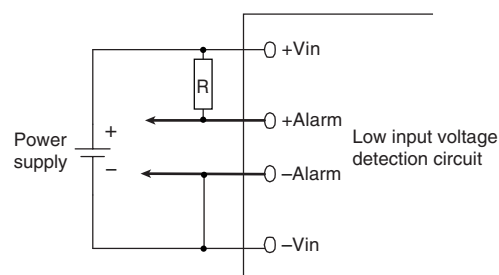

## CCP Type

### SHAPES AND DIMENSIONS

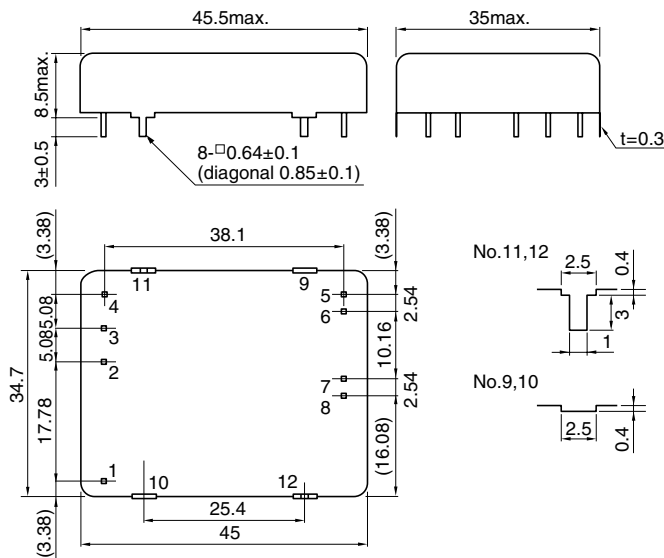

Oscillating frequency: Approx. 280kHz[Fixed]  
 MTTF: 650Fit[1500000h, 100% load]

### RECOMMENDED PWB HOLE SIZE, LOCATION[TOP VIEW]

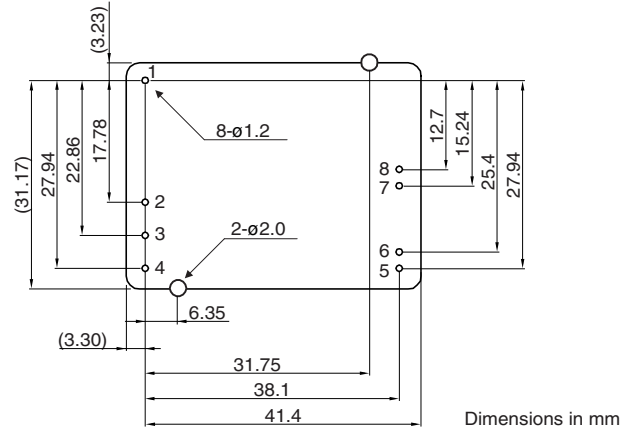

### TERMINAL PIN CONFIGURATION

Terminal No.	Function	Remark
1	+Vin	
2	-Vin	
3	+Alarm	Phototransistor Collector terminal
4	-Alarm	Phototransistor Emitter terminal
5, 6	-Vout	
7, 8	+Vout	

### COMMON SPECIFICATIONS

Overcurrent protection	Yes
Remote ON-OFF	Yes
Temperature range	Operating(°C) -20 to +70[Derating is necessary when operating environment temperature exceed 50°C.] Storage(°C) -40 to +85
Humidity range	Operating(%)RH 95 max.[Maximum wet-bulb temperature: 38°C, without dewing] Storage(%)RH 95 max.[Maximum wet-bulb temperature: 38°C, without dewing]
Amplitude	10 to 55Hz, all amplitude 1.52mm, sweep time 15min.[3 directions of X, Y, Z, each 2h]
Vibration	980m/s <sup>2</sup> (100G) 6ms[6 directions, each 3 times]
Withstand voltage Eac	Input to output, input to case, output to case: 500V, 1min.
Insulation resistance	Input to output, input to case, output to case: 50MΩ min.[DC.500V]
External dimensions	45.5×8.5×35.0mm[W×H×D]
Weight	30g

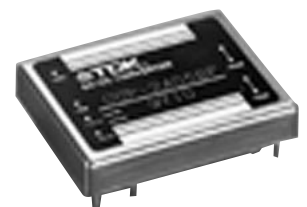

## Characteristics, Functions, and Applications

### TERMINAL CONNECTION

Be very careful with coupling input wires. An incorrect terminal connection or polarity may damage a converter.

#### • OUTPUT VOLTAGE ADJUSTMENT TERMINAL (Vset) (except CCP Type)

The following output voltages can be outputted by connecting this terminal to an output + or – terminal. Unless the output voltage is adjusted, this terminal should be open.

Part No.	Open	–Vout shorted	+Vout shorted
XX03SF	3.3V	3.67V	2.84V
XX05SF	5V	6V	4.3V
XX12SF	12V	15V	—
XX12DF	±12V	±15V	—

In addition, the voltages can be adjusted not by shorting these terminals, but by connecting them to resistances as shown below.

Part No.	Open	–Vout connected with resistance	+Vout connected with resistance
XX03SF	3.3V	3.3 to 3.67V <sup>*1</sup>	3.3 to 2.84V <sup>*5</sup>
XX05SF	5V	5 to 6 <sup>*2</sup>	5 to 4.3V <sup>*6</sup>
XX12SF	12V	12 to 15V <sup>*3</sup>	—
XX12DF	±12V	±12 to ±15V <sup>*4</sup>	—

#### • Calculation formula

Connection resistance: R(k $\Omega$ )

$$^*1 V_o = (3.3 \times R + 36.7) / (R + 10)$$

$$^*2 V_o = 2.5 \times [2 + 2.7 / (R + 6.8)]$$

$$^*3 V_o = 2.5 + 9.5 (R + 10.9) / (R + 8.2)$$

$$^*4 V_o = 2.5 + 22 \times (R + 12.7) / (R + 10) \text{ [Between two outputs]}$$

$$^*5 V_o = (3.3 \times R + 36.7) / (R + 12.92)$$

$$^*6 V_o = 2.5 \times [2 - 2.7 / (R + 9.5)]$$

If the output voltage has been adjusted to be higher, it should be noted that the output current needs to be derated so as to be suitable for the maximum power. If there is a possibility that a surge voltage is applied to the output section when this product is used at 12V or ±12V, connect a capacitor of approx. 0.01 to 0.1 $\mu$ F between the Vset and output GND terminals.

To improve an accuracy of the output voltage (for example, suppressed to  $V_o \pm 0.5\%$  or lower), arrange the wiring as shown below to adjust the output voltage.

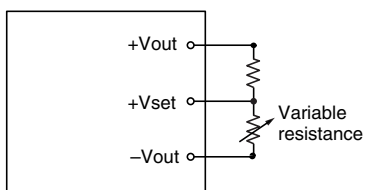

#### • DUAL-OUTPUT CONNECTION METHOD(except CCP Type)

As for a dual-output converter, it is also possible to obtain a double-output voltage (24V output for ±12V output) by connecting a load between the plus and minus outputs with the GND terminal open.

### NOISE REDUCTION

In measuring the converter noise, a value may have a significantly large deviation according to a measuring method in case of an inaccurate measurement. The measurement should be performed at the base of the terminal and no loop should be made to prevent flux from being gathered at a connection of a probe.

In addition, it should be noted that a spike voltage largely depends upon a ripple voltmeter or a frequency band of an oscilloscope.

The TDK noise measurement is performed at the base of each terminal in the 50MHz frequency band. If such significant deviation of values is a problem, the measurement system should be reviewed.

#### • INPUT NOISE

This converter incorporates a filter circuit as shown below in an input section. Therefore, it operates without any external capacitor attached to the input section. A connection of a capacitor, however, forms  $\pi$  filter and reduces input return noise.

If there is a long distance from the input power supply to the input section of the converter, connect a capacitor at the base of the input terminal, if possible. The capacitor connected to the input power supply portion does not have so much effect in some cases.

A long distance from the input power supply to the input section of the converter may cause high impedance of an input line, thereby increasing spike noise. Therefore, it is recommended to connect a capacitor in this condition, if possible.

A capacity range of the external capacitor is approx. 0 to 470 $\mu$ F. Select and connect the optimum one according to your conditions for use.

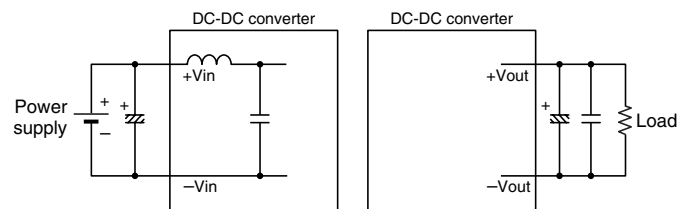

#### • OUTPUT NOISE

If an output ripple is reduced, connect a capacitor of approx. 0 to 220 $\mu$ F to the output section of the converter. The noise is further reduced by a connection of  $\pi$  filter as shown below. In this connection, the filter should be of around 0 to 100 $\mu$ F.

To reduce output spike noise, connect a ceramic capacitor of approx. 0 to 1 $\mu$ F to the output section of the converter.

If the wiring pattern between the converter output and the load is long, the capacitor should be located at the base of the load as far as possible. The capacitor installed close to the base of the output of the converter may have so much effect.

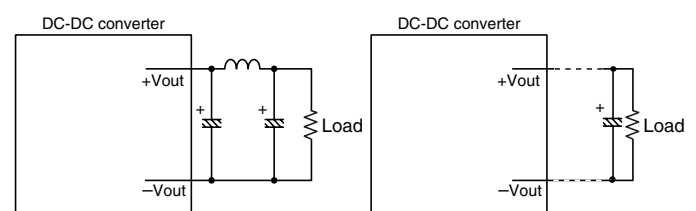

## Characteristics, Functions, and Applications

### • COMMON MODE NOISE

To reduce the common mode noise, connect a capacitor of 0 to 1000pF between the primary side and the secondary side. Be careful with this connection; a coupling capacitance between the input and the output becomes high if a too big capacitor is connected.

Furthermore, care should be taken for the withstand voltage of the capacitor (500V or higher is desirable from the viewpoint of the insulation and high voltage safety requirements).

If the converter is used not as an insulation type, but as a non-insulation type, a short circuit is required between the GND terminal of the primary side and that of the secondary side.

### • RADIATED NOISE

Radiated noise of the converter is reduced by connecting a ground terminal of the case to the GND of an input or of an output.

It should be noted, however, that its effect depends upon a device to be used. In addition, the wiring pattern should be made on a bottom surface of the converter in a plain pattern with a GND line, if possible.

### SERIES AND PARALLEL CONNECTIONS

#### • SERIES CONNECTION

It is possible to form a series connection with wiring as shown below. When the output voltage is not turned on with this connection, connect Schottky barrier diodes having a forward voltage that is as low as possible, as shown below.

The Schottky barrier diodes used for this purpose should have a reverse withstand voltage twice or more the voltage between the +Vout and -Vout terminals. The output current should be used at a level equal to or lower than the smaller rated current of the converters.

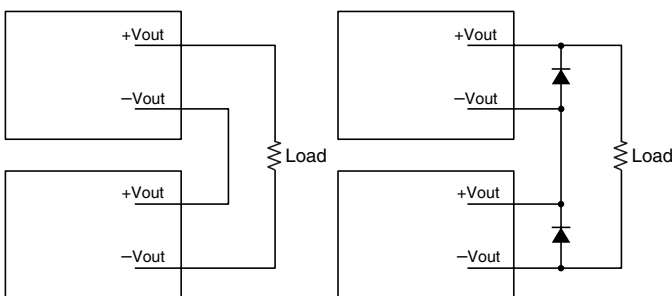

### • PARALLEL OPERATION

Parallel operation to increase output current is not possible.

### SOLDERING CONDITIONS

Soldering dip: 260°C, 10s max.

Soldering iron: 350°C, 3s max.

### CLEANING CONDITIONS

It is recommended that the PC board should not be cleaned after soldering. It, however, has already been checked that there is no problem as a result of the following cleaning tests.

When cleaning with one of the following cleaning agents, it should be used under these conditions. When using cleaning agent other than the following, please consult TDK before use.

### • CLEANING AGENTS AND TEST CONDITIONS

Clean Through 750H (Kao Corporation)

- (1) Cleaning (Agitation) 60°C/4min
- (2) Rinsing (Agitation, water) 60°C/8min
- (3) Drying 70°C/6min

Pine Alpha ST100S (Arakawa Chemical Industries, Ltd.)

- (1) Cleaning (Agitation) 60°C/5min
- (2) Rinsing (Agitation, water) 60°C/3min
- (3) Drying 70°C/6min

Terpene Cleaner EC-7R



- (1) Cleaning (Agitation) 60°C/5min
- (2) Rinsing (Agitation, IPA) 30°C/10min
- (3) Drying 70°C/6min

Isopropyl Alcohol (Tokuyama Corp., etc.)

- (1) Ultrasonic cleaning 60°C/1min
- (2) Cooling bath cleaning R.T./1min
- (3) Vapor cleaning 83°C/1min

## Looking for pricing, stock, or lifecycle information?

Click below to explore more details on WIN SOURCE:

-  [View CCK-0512DF on WIN SOURCE](#)
-  [TDK-Lambda Americas Inc. Information](#)

## Optimize Your Supply Chain with WIN SOURCE Solutions

-  Global Sourcing Solution
-  Obsolete Management
-  Cost Control Management
-  Shortage Management
-  Alternative Solution
-  Excess Inventory Management