



**THE DATASHEET OF  
HLMP-4740-A0002**



**HLMP-4700, HLMP-4719, HLMP-4740  
HLMP-1700, HLMP-1719, HLMP-1790  
T-1<sup>3/4</sup> (5 mm), T-1 (3 mm), Low Current LED  
Lamps**



---

## Description

These Broadcom® tinted diffused LED lamps are designed and optimized specifically for low DC current operation. Luminous intensity and forward voltage are tested at 2 mA to assure consistent brightness at TTL output current levels.

## Features

- Low power
- High efficiency
- CMOS-MOS compatible
- TTL compatible
- Wide viewing angle
- Choice of package styles
- Choice of colors
- AlInGaP LED technology

## Applications

- Low power DC circuits
- Telecommunications indicators
- Portable equipment
- Keyboard indicators

Figure 1: Package Dimensions

A – HLMP-4700, 4719, 4740

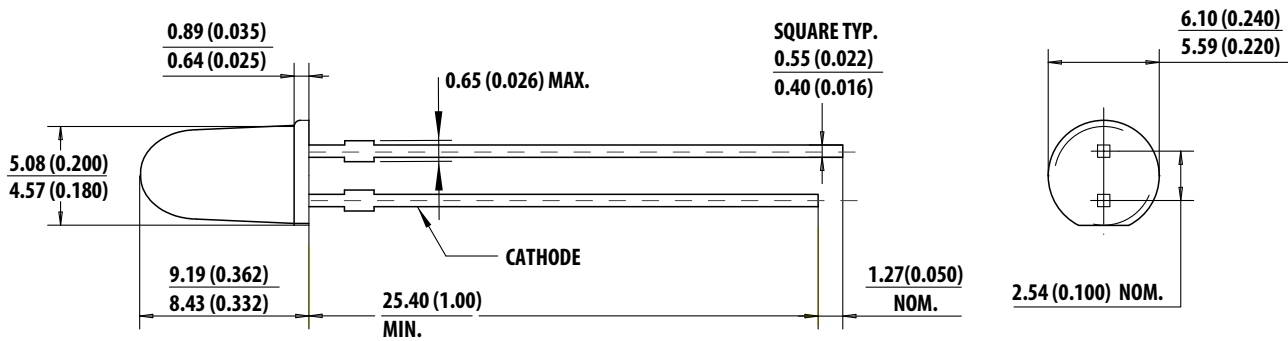

B – HLMP-1700, 1719, 1790

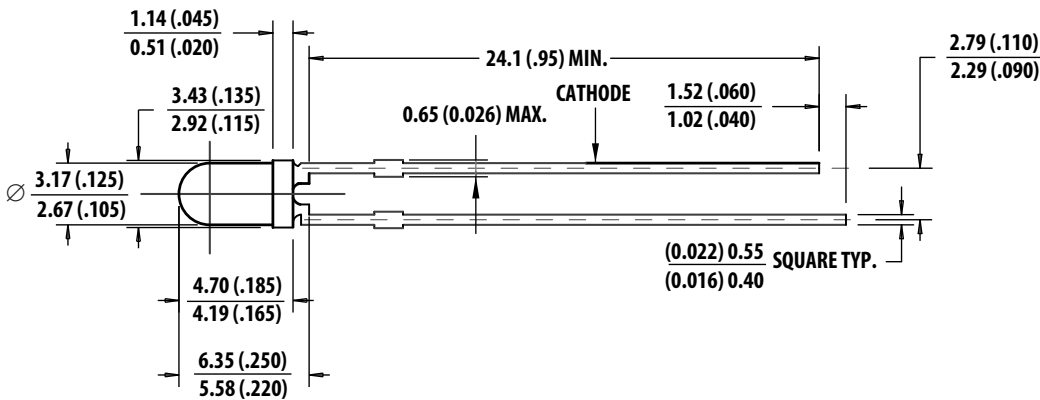

NOTE:

1. All dimensions are in mm (inches).
2. An epoxy meniscus may extend about 1 mm (0.040 in.) down the leads.
3. For PCB hole recommendations, see [Precautions](#).

## Device Selection Guide ( $T_J = 25^\circ\text{C}$ , $I_F = 2\text{ mA}$ )

Package Description	Color	Part Number	Luminous Intensity, $I_V$ (mcd) <sup>a, b</sup>			Viewing Angle $2\theta_{1/2}^c$	Package Drawing			
			Min.	Typ.	Max.					
T-1¼ Tinted Diffused	Red	HLMP-4700	1.3	2.3	—	50	A			
		HLMP-4700-C0002	1.3	2.3	—					
		HLMP-4700-C00B2	1.3	2.3	—					
	Yellow	HLMP-4719	0.9	2.1	—					
		HLMP-4719-A0002	0.9	2.1	—					
		HLMP-4719-A00B2	0.9	2.1	—					
	Green	HLMP-4740	1.0	2.3	—					
		HLMP-4740-A0002	1.0	2.3	—					
		HLMP-4740-A00B1	1.0	2.3	—					
		HLMP-4740-A00B2	1.0	2.3	—					
	T-1 Tinted Diffused	Red	HLMP-1700	0.8	2.1			—	50	B
			HLMP-1700-B0002	0.8	2.1			—		
HLMP-1700-B00A1			0.8	2.1	—					
HLMP-1700-B00A2			0.8	2.1	—					
Yellow		HLMP-1719	0.9	2.1	—					
		HLMP-1719-A0002	0.9	2.1	—					
		HLMP-1719-A00A1	0.9	2.1	—					
		HLMP-1719-A00A2	0.9	2.1	—					
Green		HLML-1790	1.0	2.3	—					
		HLMP-1790-A0002	1.0	2.3	—					
		HLMP-1790-A00A1	1.0	2.3	—					
		HLMP-1790-A00A2	1.0	2.3	—					

- a. The luminous intensity,  $I_V$ , is measured at the mechanical axis of the package and it is tested with a single current pulse condition.  
 b. The optical axis is closely aligned with the mechanical axis of the package.  
 c.  $\theta_{1/2}$  is the typical off-axis angle at which the luminous intensity is half the axial luminous intensity.

## Absolute Maximum Ratings

Parameter		Maximum Rating	Units
Power Dissipation (Derate linearly from 92°C at 1.0 mA/°C)	Red	14	mW
	Yellow	17.5	
	Green	15.4	
DC and Peak Forward Current		7	mA
Reverse Voltage ( $I_R = 50\ \mu\text{A}$ )		5.0	V
Operating Temperature Range	Red/Yellow	-40 to 100	°C
	Green	-20 to 100	
Storage Temperature Range		-40 to +100	°C

## Electrical/Optical Characteristics at $T_A = 25^\circ\text{C}$

Symbol	Description	T-1¼	T-1	Min.	Typ.	Max.	Units	Test Conditions
$V_F$	Forward Voltage	4700	1700	—	1.9	2.0	V	2 mA
		4719	1719	—	1.9	2.5		
		4740	1790	—	1.9	2.2		
$V_R$	Reverse Breakdown Voltage	4700	1700	5.0	—	—	V	$I_R = 50 \mu\text{A}$
		4719	1719	5.0	—	—		
		4740	1790	5.0	—	—		
$\lambda_d$	Dominant Wavelength	4700	1700	—	626	—	nm	Note <sup>a</sup>
		4719	1719	—	589	—		
		4740	1790	—	569	—		
$\Delta\lambda_{1/2}$	Spectral Line Halfwidth	4700	1700	—	14	—	nm	
		4719	1719	—	12	—		
		4740	1790	—	13	—		
$\tau_S$	Speed of Response	4700	1700	—	90	—	ns	
		4719	1719	—	90	—		
		4740	1790	—	500	—		
C	Capacitance	4700	1700	—	11	—	pF	$V_F = 0, f = 1 \text{ MHz}$
		4719	1719	—	15	—		
		4740	1790	—	18	—		
$R\theta_{J-PIN}$	Thermal Resistance	4700	1700	—	260 <sup>b</sup>	—	$^\circ\text{C/W}$	Junction to Cathode Lead
		4719	1719	—	290 <sup>c</sup>	—		
		4740	1790	—	—	—		
$\lambda_{PEAK}$	Peak Wavelength	4700	1700	—	632	—	nm	Measurement at Peak
		4719	1719	—	590	—		
		4740	1790	—	570	—		
hV	Luminous Efficacy	4700	1700	—	180	—	lumens/watt	Note <sup>d</sup>
		4719	1719	—	500	—		
		4740	1790	—	640	—		

- a. The dominant wavelength,  $\lambda_d$ , is derived from the CIE chromaticity diagram and represents the single wavelength which defines the color of the device.
- b. T-1¼.
- c. T-1.
- d. The radiant intensity,  $I_e$ , in watts per steradian, may be found from the equation  $I_e = I_V / \eta_V$ , where  $I_V$  is the luminous intensity in candelas and  $\eta_V$  is luminous efficacy in lumens/watt.

## Part Numbering System

H L M P - x<sub>1</sub> 7 x<sub>2</sub> x<sub>3</sub> - x<sub>4</sub> x<sub>5</sub> x<sub>6</sub> x<sub>7</sub> x<sub>8</sub>

Code	Description	Option	
x <sub>1</sub>	Package Type	1	T-1 (3 mm)
		4	T - 1¼ (5 mm)
x <sub>2</sub> x <sub>3</sub>	Color	00	Red
		19	Yellow
		40	Green
		90	Green
x <sub>4</sub>	Minimum Intensity Bin	See <a href="#">Intensity Bin Limits</a>	
x <sub>5</sub>	Maximum Intensity Bin	0	Open bins (no maximum I <sub>V</sub> bin limit)
		Others	See <a href="#">Intensity Bin Limits</a>
x <sub>6</sub>	Color Bin Option	0	Full distribution
x <sub>7</sub> x <sub>8</sub>	Packing Option	00	Bulk (loose forms packaging)
		01	Tape and Reel, Crimped Leads
		02	Tape and Reel, Straight Leads
		A1, B1	Right-Angle Housing, Uneven Leads
		A2, B2	Right-Angle Housing, Even Leads
		FH	2 IV Bins Selection with Inventory Control

**NOTE:** For part number HLMP-xxxx (for example, HLMP-1790), the packing option is in loose form (bulk).

## Bin Information

### Intensity Bin Limits

Color	Bin	Intensity Range (mcd)	
		Min.	Max.
Red	B	0.9	1.5
	C	1.5	2.4
	D	2.4	3.8
	E	3.8	6.1
	F	6.1	9.7
	G	9.7	15.5
	H	15.5	24.8
	I	24.8	39.6
	J	39.6	63.4
	K	63.4	101.5
	L	101.5	162.4
	M	162.4	234.6
	N	234.6	340.0
	O	340.0	540.0
	P	540.0	850.0
	Q	850.0	1200.0
	R	1200.0	1700.0
	S	1700.0	2400.0
	T	2400.0	3400.0
	U	3400.0	4900.0
V	4900.0	7100.0	
W	7100.0	10200.0	
X	10200.0	14800.0	
Y	14800.0	21400.0	
Z	21400.0	30900.0	

Maximum tolerance for each bin limit is ±18%.

### Intensity Bin Limits

Color	Bin	Intensity Range (mcd)	
		Min.	Max.
Yellow	A	1.0	1.6
	B	1.6	2.5
	C	2.5	4.0
	D	4.0	6.5
	E	6.5	10.3
	F	10.3	16.6
	G	16.6	26.5
	H	26.5	42.3
	I	42.3	67.7
	J	67.7	108.2
	K	108.2	173.2
	L	173.2	250.0
	M	250.0	360.0
	N	360.0	510.0
	O	510.0	800.0
	P	800.0	1250.0
	Q	1250.0	1800.0
	R	1800.0	2900.0
	S	2900.0	4700.0
	T	4700.0	7200.0
U	7200.0	11700.0	
V	11700.0	18000.0	
W	18000.0	27000.0	

Maximum tolerance for each bin limit is ±18%.

## Intensity Bin Limits

Color	Bin	Intensity Range (mcd)	
		Min.	Max.
Green	A	1.1	1.8
	B	1.8	2.9
	C	2.9	4.7
	D	4.7	7.6
	E	7.6	12.0
	F	12.0	19.1
	G	19.1	30.7
	H	30.7	49.1
	I	49.1	78.5
	J	78.5	125.7
	K	125.7	201.1
	L	201.1	289.0
	M	289.0	417.0
	N	417.0	680.0
	O	680.0	1100.0
	P	1100.0	1800.0
	Q	1800.0	2700.0
	R	2700.0	4300.0
	S	4300.0	6800.0
T	6800.0	10800.0	
U	10800.0	16000.0	
V	16000.0	25000.0	
W	25000.0	40000.0	

Maximum tolerance for each bin limit is ±18%.

## Packaging Option Matrix

Option Code	Definition
00	Bulk Packaging, minimum increment 500 pieces/bag
01	Tape and Reel, crimped leads, minimum increment 1300 pieces/reel for T-1¼, 1800 pieces/reel for T-1
02	Tape and Reel, straight leads, minimum increment 1300 pieces/reel for T-1¼, 1800 pieces/reel for T-1
A1	T-1, Right Angle Housing, uneven leads, minimum increment 500 pieces/bag
A2	T-1, Right Angle Housing, even leads, minimum increment 500 pieces/bag
B1	T-1¼, Right Angle Housing, uneven leads, minimum increment 500 pieces/bag
B2	T-1¼, Right Angle Housing, even leads, minimum increment 500 pieces/bag
FH	Devices that require inventory control and 2 lv bin select

**NOTE:** All categories are established for classification of products. Products may not be available in all categories. Contact your local Broadcom representative for further clarification/information.

## Color Categories

Color	Category Number	Lambda (nm)	
		Min.	Max.
Green	6	561.5	564.5
	5	564.5	567.5
	4	567.5	570.5
	3	570.5	573.5
	2	573.5	576.5
	Yellow	1	582.0
3		584.5	587.0
2		587.0	589.5
4		589.5	592.0
5		592.0	593.0

Tolerance for each bin limit is ±0.5 nm.

Figure 2: Relative Intensity vs. Wavelength

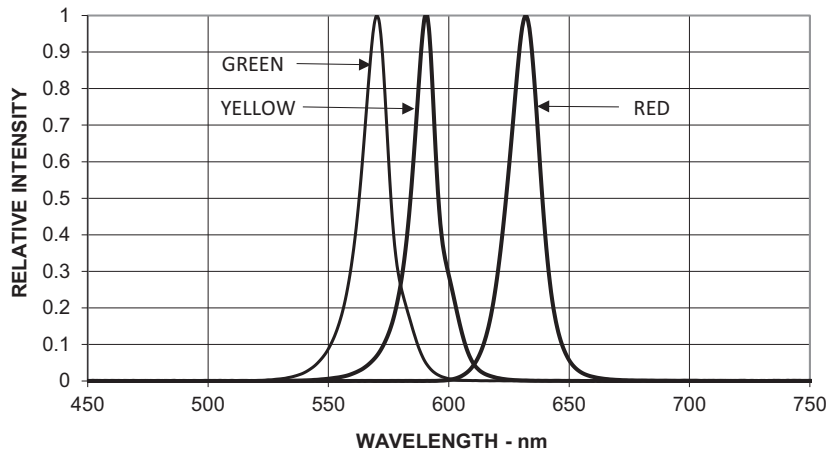

Figure 3: Forward Current vs. Forward Voltage

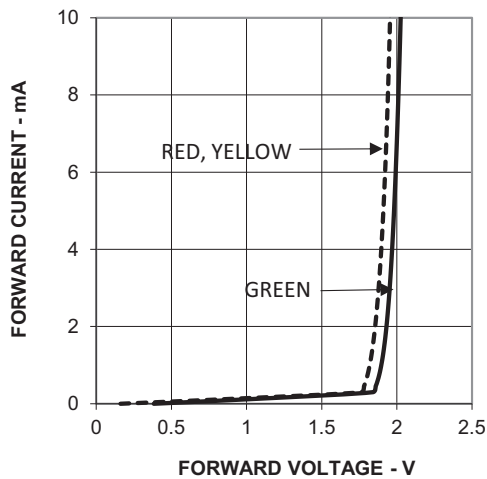

Figure 4: Relative Luminous Intensity vs. Forward Current

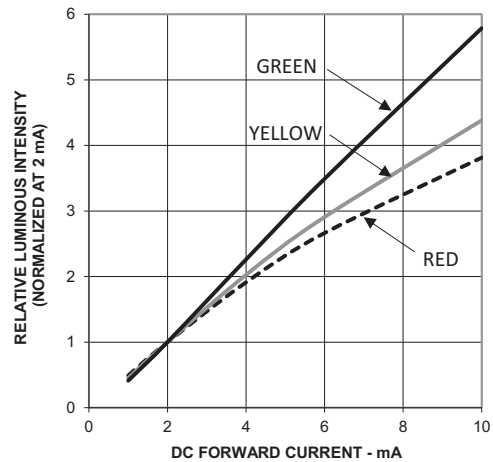

Figure 5: Relative Luminous Intensity vs. Angular Displacement for T-1¼ Lamp

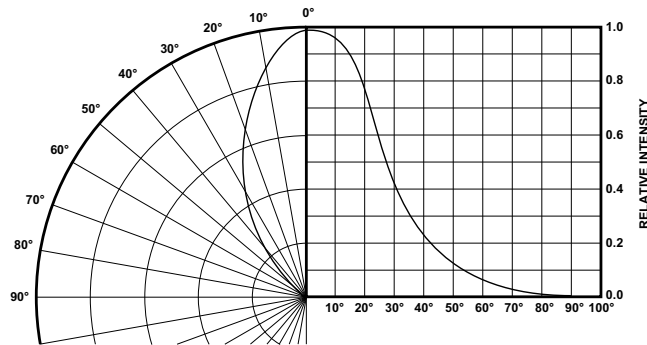
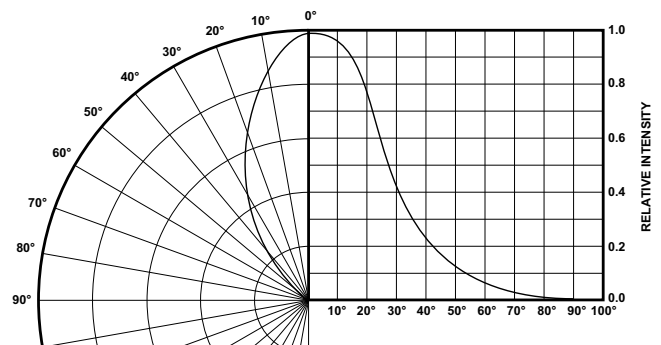













Figure 6: Relative Luminous Intensity vs. Angular Displacement for T-1 Lamp









## Packaging Label

### (i) Mother Label: (Available on packaging box of ammo pack and shipping box)

	
(1P) Item: <b>Part Number</b> 	STANDARD LABEL LS0002 RoHS Compliant e3 max temp 250C
(1T) Lot: <b>Lot Number</b> 	(Q) QTY: <b>Quantity</b> 
LPN: 	CAT: <b>Intensity Bin</b> 
(9D)MFG Date: <b>Manufacturing Date</b> 	BIN: <b>Color Bin</b>
<hr/>	
(P) Customer Item: 	
(V) Vendor ID: 	(9D) Date Code: <b>Date Code</b> 
<hr/>	
DeptID: 	Made In: <b>Country of Origin</b> 

### (ii) Baby Label (Only available on bulk packaging)

	
<b>Lamps Baby Label</b>	
RoHS Compliant e3 max temp 250C	
(1P) PART #: <b>Part Number</b> 	
(1T) LOT #: <b>Lot Number</b> 	
(9D)MFG DATE: <b>Manufacturing Date</b> 	QUANTITY: <b>Packing Quantity</b> 
C/O: <b>Country of Origin</b>	
<hr/>	
Customer P/N: 	CAT: <b>Intensity Bin</b> 
Supplier Code: 	BIN: <b>Color Bin</b> 
	DATECODE: <b>Date Code</b> 

## Precautions

### Lead Forming

- Preform or cut the leads of an LED lamp to length prior to insertion and soldering on PC board.
- For better control, use the proper tool to precisely form and cut the leads to applicable length rather than doing it manually.
- If manual lead cutting is necessary, cut the leads after the soldering process. The solder connection forms a mechanical ground that prevents mechanical stress due to lead cutting from traveling into LED package. Do this action for hand solder operation, because the excess lead length also acts as small heat sink.

### Soldering and Handling

- Take care during the PCB assembly and soldering process to prevent damage to the LED component.
- LED component may be effectively hand soldered to PCB. However, do this under unavoidable circumstances such as rework. The closest manual soldering distance of the soldering heat source (soldering iron's tip) to the body is 1.59 mm. Soldering the LED using soldering iron tip closer than 1.59 mm might damage the LED.

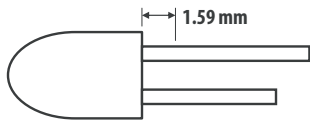

- Apply ESD precaution on the soldering station and personnel to prevent ESD damage to the LED component that is ESD sensitive. Refer to Broadcom application note AN 1142 for details. Use a soldering iron with a grounded tip to ensure that electrostatic charge is properly grounded.
- Use the following soldering conditions.

	Wave Soldering <sup>a, b</sup>	Manual Solder Dipping
Pre-heat Temperature	105°C max.	—
Pre-heat Time	60s Max.	—
Peak Temperature	250°C max.	260°C max.
Dwell Time	3s max.	5s max.

- The preceding conditions refer to measurements with the thermocouple mounted at the bottom of the PCB.
- Use only bottom preheaters to reduce thermal stress experienced by the LED.

- Set and maintain wave soldering parameters according to the recommended temperature and dwell time. Perform a daily check on the soldering profile to ensure that it conforms to the recommended soldering conditions.

#### NOTE:

- PCBs with different sizes and design s(component density) have different heat mass (heat capacity). This might cause a change in temperature experienced by the board if same wave soldering setting is used. Recalibrate the soldering profile again before loading a new type of PCB.
  - Take extra precautions during wave soldering to ensure that the maximum wave temperature does not exceed 250°C and the solder contact time does not exceed 3s. Over- stressing the LED during soldering process might cause premature failure to the LED due to delamination.
- Loosely fit any alignment fixture that is being applied during wave soldering, and do not apply weight or force on the LED. Use non-metal material because it will absorb less heat during the wave soldering process.
  - At elevated temperatures, LED is more susceptible to mechanical stress. Therefore, allows the PCB to cool down to room temperature prior to handling, which includes removal of the alignment fixture or pallet.
  - If PCB board contains both through hole (TH) LED and other surface-mount components, solder surface-mount components on the top side of the PCB. If surface mount must be on the bottom side, solder these components using reflow soldering prior to insertion of the TH LED.
  - Use the following PC board plated through holes (PTH) size for LED component leads.

	LED Component Lead Size	Diagonal	Plated Through-Hole Diameter
Lead size (typ.)	0.45 × 0.45 mm (0.018 × 0.018 in.)	0.636 mm (0.025 in.)	0.98 to 1.08 mm (0.039 to 0.043 in.)
Dambar shear-off area (max.)	0.65 mm (0.026 in)	0.919 mm (0.036 in)	
Lead size (typ.)	0.50 × 0.50 mm (0.020 × 0.020 in.)	0.707 mm (0.028 in)	1.05 to 1.15 mm (0.041 to 0.045 in.)
Dambar shear-off area (max.)	0.70 mm (0.028 in.)	0.99 mm (0.039 in.)	

**NOTE:** Refer to application note AN1027 for more information on soldering LED components.

- Over-sizing the PTH can lead to a twisted LED after clinching. Under-sizing the PTH can cause difficulty inserting the TH LED.

Refer to application note AN5334 for more information about soldering and handling of TH LED lamps.

Figure 7: Example of Wave Soldering Temperature Profile for TH LED

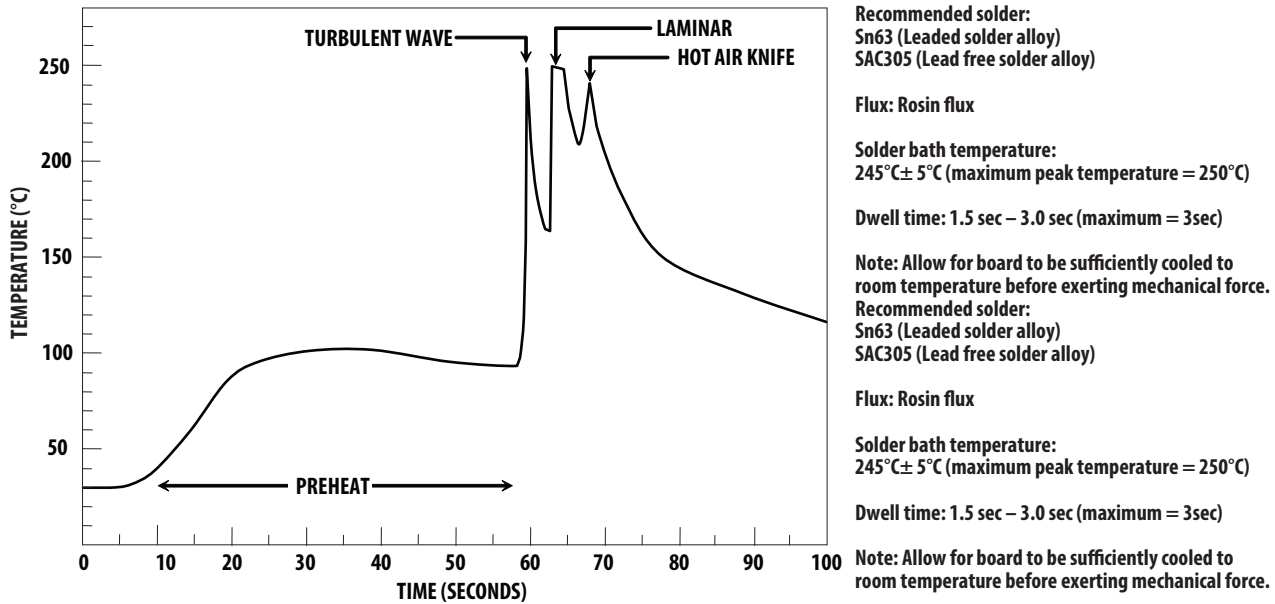

Broadcom, the pulse logo, Connecting everything, Avago Technologies, Avago, and the A logo are among the trademarks of Broadcom and/or its affiliates in the United States, certain other countries, and/or the EU.

Copyright © 2014–2021 Broadcom. All Rights Reserved.

The term “Broadcom” refers to Broadcom Inc. and/or its subsidiaries. For more information, please visit [www.broadcom.com](http://www.broadcom.com).

Broadcom reserves the right to make changes without further notice to any products or data herein to improve reliability, function, or design. Information furnished by Broadcom is believed to be accurate and reliable. However, Broadcom does not assume any liability arising out of the application or use of this information, nor the application or use of any product or circuit described herein, neither does it convey any license under its patent rights nor the rights of others.

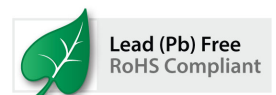

## Looking for pricing, stock, or lifecycle information?

Click below to explore more details on WIN SOURCE:

 [View HLMP-4740-A0002 on WIN SOURCE](#)

 [Broadcom Limited](#) Information

## Optimize Your Supply Chain with WIN SOURCE Solutions

-  Global Sourcing Solution
-  Obsolete Management
-  Cost Control Management
-  Shortage Management
-  Alternative Solution
-  Excess Inventory Management