

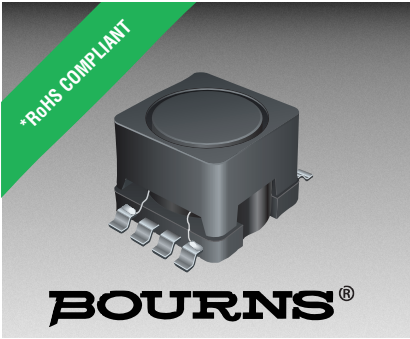

**THE DATASHEET OF
SRR0906-822YL**





Features

- Available in E6 series
- High inductance up to 10 mH
- Low 6.0 mm profile
- Gull wing leads
- RoHS compliant*

Applications

- Input/output of DC/DC converters
- Power supplies for:
 - Portable communication equipment
 - Camcorders
 - LCD TVs

SRR0906 Series - SMD Shielded Power Inductors

Electrical Specifications

Bourns Part No.	Inductance 1 KHz		Q Ref.	Test Frequency (MHz)	SRF Min. (MHz)	RDC Max. (Ω)	I rms Max. (A)	I sat Typ. (A)	**K- Factor
	μH	Tol. %							
SRR0906-2R7ML	2.7	±20	23	7.96	85.0	0.032	3.20	5.80	173
SRR0906-3R5ML	3.5	±20	23	7.96	80.0	0.036	2.90	5.20	148
SRR0906-4R7ML	4.7	±20	23	7.96	40.0	0.040	2.70	4.30	130
SRR0906-5R6ML	5.6	±20	23	7.96	57.0	0.046	2.50	4.20	115
SRR0906-6R8ML	6.8	±20	23	7.96	38.0	0.050	2.30	3.40	104
SRR0906-8R2ML	8.2	±20	23	7.96	30.0	0.055	2.10	3.20	94
SRR0906-100ML	10	±20	35	2.52	29.0	0.080	1.80	2.70	80
SRR0906-120ML	12	±20	35	2.52	26.0	0.085	1.70	2.60	74
SRR0906-150ML	15	±20	35	2.52	23.0	0.100	1.60	2.40	65
SRR0906-180ML	18	±20	35	2.52	22.0	0.110	1.50	2.00	61
SRR0906-220ML	22	±20	35	2.52	19.0	0.130	1.40	1.90	52
SRR0906-270ML	27	±20	35	2.52	17.0	0.140	1.30	1.80	47
SRR0906-330ML	33	±20	35	2.52	15.0	0.150	1.20	1.60	43
SRR0906-390ML	39	±20	35	2.52	14.0	0.160	1.10	1.40	42
SRR0906-470ML	47	±20	35	2.52	12.0	0.180	1.00	1.30	36
SRR0906-560ML	56	±20	35	2.52	12.0	0.300	0.93	1.20	34
SRR0906-680ML	68	±20	40	2.52	9.0	0.350	0.85	1.00	31
SRR0906-820ML	82	±20	40	2.52	8.0	0.370	0.78	0.90	28
SRR0906-101YL	100	±15	40	0.796	7.5	0.420	0.70	0.90	25
SRR0906-121YL	120	±15	40	0.796	7.0	0.480	0.65	0.75	23
SRR0906-151YL	150	±15	40	0.796	6.0	0.550	0.60	0.70	20
SRR0906-181YL	180	±15	40	0.796	5.5	0.820	0.52	0.70	19
SRR0906-221YL	220	±15	40	0.796	5.0	1.000	0.48	0.60	16
SRR0906-271YL	270	±15	40	0.796	5.0	1.100	0.44	0.55	15
SRR0906-331YL	330	±15	40	0.796	4.5	1.300	0.40	0.51	13
SRR0906-391YL	390	±15	40	0.796	4.2	1.400	0.38	0.50	12
SRR0906-471YL	470	±15	40	0.796	4.0	1.600	0.35	0.40	11
SRR0906-561YL	560	±15	60	0.796	3.2	2.700	0.28	0.35	11
SRR0906-681YL	680	±15	60	0.796	2.7	3.200	0.25	0.33	9
SRR0906-821YL	820	±15	85	0.796	2.6	3.500	0.23	0.30	9
SRR0906-102YL	1000	±15	100	0.252	2.3	4.000	0.22	0.26	8
SRR0906-122YL	1200	±15	100	0.252	2.3	4.400	0.20	0.24	7
SRR0906-152YL	1500	±15	100	0.252	2.0	5.200	0.18	0.22	6
SRR0906-182YL	1800	±15	100	0.252	1.7	7.000	0.17	0.20	6
SRR0906-222YL	2200	±15	100	0.252	1.5	8.500	0.16	0.18	5
SRR0906-272YL	2700	±15	100	0.252	1.4	9.200	0.14	0.17	5
SRR0906-332YL	3300	±15	100	0.252	1.3	11.000	0.12	0.15	4
SRR0906-392YL	3900	±15	100	0.252	1.2	16.000	0.11	0.13	4
SRR0906-472YL	4700	±15	100	0.252	1.0	19.000	0.10	0.11	4
SRR0906-562YL	5600	±15	100	0.252	0.9	21.000	0.09	0.11	3
SRR0906-682YL	6800	±15	100	0.252	0.9	24.000	0.09	0.10	3
SRR0906-822YL	8200	±15	100	0.252	0.8	31.000	0.08	0.09	3
SRR0906-103YL	10000	±15	100	0.0796	0.7	38.000	0.07	0.08	2

General Specifications

Test Voltage 1 V
 Reflow Soldering .. 230 °C, 50 sec. max.
 Operating Temperature
 -40 °C to +125 °C
 (Temperature rise included)
 Storage Temperature .. -40 °C to +125 °C
 Resistance to Soldering Heat
 260 °C for 5 sec.
 Moisture Sensitivity Level 1
 ESD Classification (HBM) N/A

Materials

Core Ferrite DR & RI
 Wire Enameled copper
 Base LCP
 Terminal Cu/Ni/Sn
 Adhesive Epoxy resin
 Rated Current
 Ind. drop of 10 % typ. at Isat
 Temp. Rise 40 °C max. at rated I rms
 Packaging 600 pcs. per reel

Product Dimensions

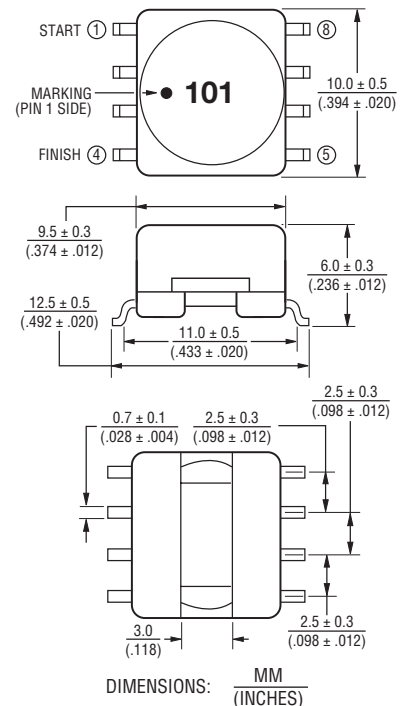

Schematic



Multiple windings possible (up to four windings).

**K-Factor: To calculate core flux density, Bp-p (gauss) = K x L(μH) x Δ I (peak-to-peak ripple current, A), determine core loss from Core Loss vs. Flux Density plot.

*RoHS Directive 2002/95/EC Jan. 27, 2003 including annex and RoHS Recast 2011/65/EU June 8, 2011.
 Specifications are subject to change without notice.
 The device characteristics and parameters in this data sheet can and do vary in different applications and actual device performance may vary over time.
 Users should verify actual device performance in their specific applications.

Recommended Layout



SRR0906 Series - SMD Shielded Power Inductors

BOURNS®

Core Loss vs. Flux Density

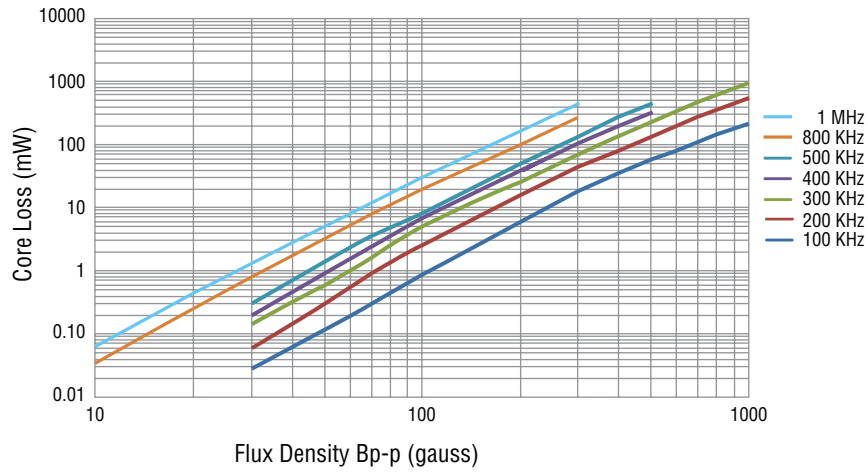

Packaging Specifications

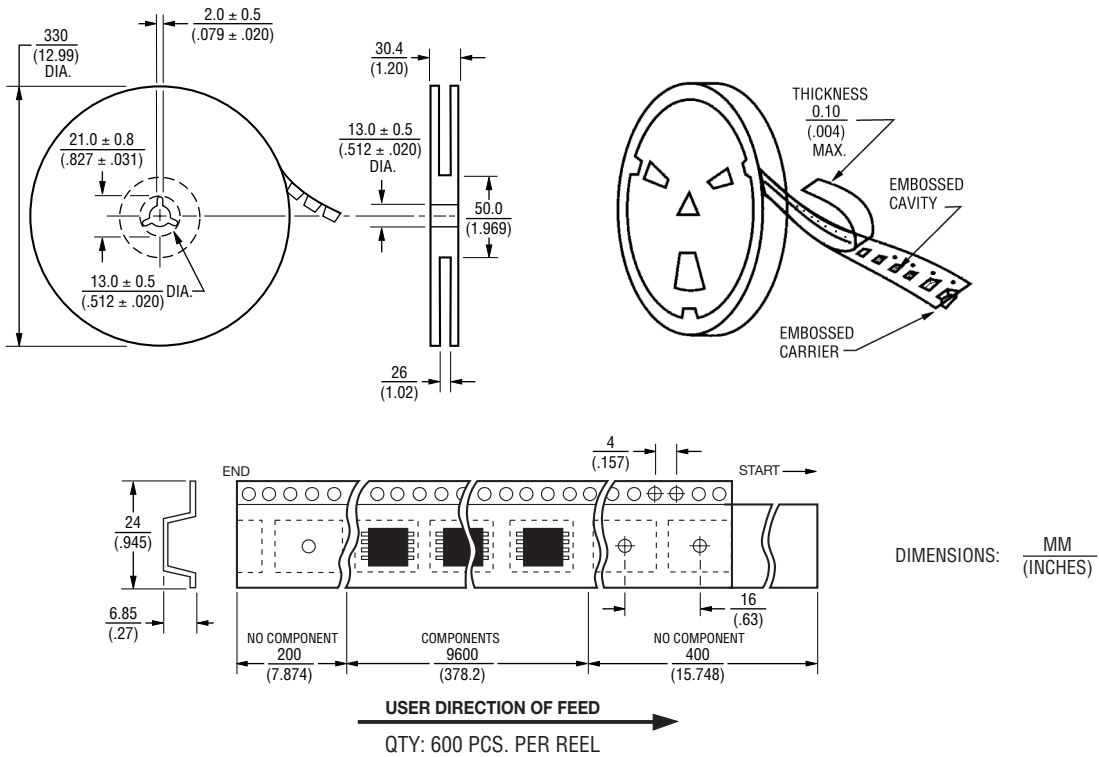

REV. 03/18

Specifications are subject to change without notice. The device characteristics and parameters in this data sheet can and do vary in different applications and actual device performance may vary over time. Users should verify actual device performance in their specific applications.

Looking for pricing, stock, or lifecycle information?

Click below to explore more details on WIN SOURCE:

- ⊖ [View SRR0906-822YL on WIN SOURCE](#)
- ⊖ [Bourns Inc. Information](#)

Optimize Your Supply Chain with WIN SOURCE Solutions

- ✓ Global Sourcing Solution
- ✓ Obsolete Management
- ✓ Cost Control Management
- ✓ Shortage Management
- ✓ Alternative Solution
- ✓ Excess Inventory Management