



**THE DATASHEET OF
AT27C1024-55JI**



Features

- Fast Read Access Time - 45 ns
- Low-Power CMOS Operation
 - 100 μ A max. Standby
 - 30 mA max. Active at 5 MHz
- JEDEC Standard Packages
 - 40-Lead 600-mil PDIP
 - 44-Lead PLCC
 - 40-Lead VSOP (10 mm x 14 mm)
- Direct Upgrade from 512K (AT27C516) EPROM
- 5V \pm 10% Power Supply
- High-Reliability CMOS Technology
 - 2000V ESD Protection
 - 200 mA Latchup Immunity
- Rapid™ Programming Algorithm - 100 μ s/word (typical)
- CMOS and TTL Compatible Inputs and Outputs
- Integrated Product Identification Code
- Commercial, Industrial and Automotive Temperature Ranges

Description

The AT27C1024 is a low-power, high-performance 1,048,576 bit one-time programmable read only memory (OTP EPROM) organized 64K by 16 bits. It requires only one 5V power supply in normal read mode operation. Any word can be accessed in less than 45 ns, eliminating the need for speed reducing WAIT states. The by-16 orga-

(continued)

Pin Configurations

Pin Name	Function
A0 - A15	Addresses
O0 - O15	Outputs
\overline{CE}	Chip Enable
\overline{OE}	Output Enable
\overline{PGM}	Program Strobe
NC	No Connect

Note: Both GND pins must be connected.

PDIP Top View



VSOP Top View
Type 1



PLCC Top View



1-Megabit (64K x 16) OTP EPROM

AT27C1024



nization make this part ideal for high-performance 16- and 32-bit microprocessor systems.

In read mode, the AT27C1024 typically consumes 15 mA. Standby mode supply current is typically less than 10 μ A.

The AT27C1024 is available in industry standard JEDEC-approved one-time programmable (OTP) plastic PDIP, PLCC, and VSOP packages. The device features two-line control (\overline{CE} , \overline{OE}) to eliminate bus contention in high-speed systems.

With high density 64K word storage capability, the AT27C1024 allows firmware to be stored reliably and to be accessed by the system without the delays of mass storage media.

Atmel's 27C1024 have additional features to ensure high quality and efficient production use. The Rapid™ Programming Algorithm reduces the time required to program the part and guarantees reliable programming. Programming time is typically only 100 μ s/word. The Integrated Product Identification Code electronically identifies the device and manufacturer. This feature is used by industry standard

programming equipment to select the proper programming algorithms and voltages.

System Considerations

Switching between active and standby conditions via the Chip Enable pin may produce transient voltage excursions. Unless accommodated by the system design, these transients may exceed data sheet limits, resulting in device non-conformance. At a minimum, a 0.1 μ F high frequency, low inherent inductance, ceramic capacitor should be utilized for each device. This capacitor should be connected between the V_{CC} and Ground terminals of the device, as close to the device as possible. Additionally, to stabilize the supply voltage level on printed circuit boards with large EPROM arrays, a 4.7 μ F bulk electrolytic capacitor should be utilized, again connected between the V_{CC} and Ground terminals. This capacitor should be positioned as close as possible to the point where the power supply is connected to the array.

Block Diagram

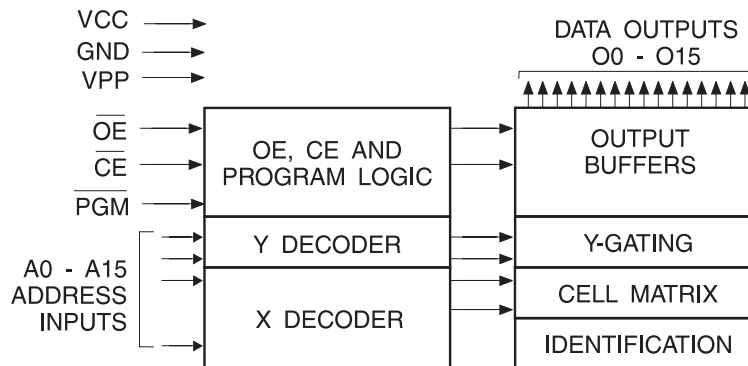

Absolute Maximum Ratings*

Temperature Under Bias	-55°C to + 125°C
Storage Temperature	-65°C to + 150°C
Voltage on Any Pin with Respect to Ground	-2.0V to + 7.0V ⁽¹⁾
Voltage on A9 with Respect to Ground	-2.0V to + 14.0V ⁽¹⁾
V _{PP} Supply Voltage with Respect to Ground	-2.0V to + 14.0V ⁽¹⁾

*NOTICE: Stresses beyond those listed under “Absolute Maximum Ratings” may cause permanent damage to the device. This is a stress rating only and functional operation of the device at these or any other conditions beyond those indicated in the operational sections of this specification is not implied. Exposure to absolute maximum rating conditions for extended periods may affect device reliability.

Note: 1. Minimum voltage is -0.6V dc which may undershoot to -2.0V for pulses of less than 20 ns. Maximum output pin voltage is V_{CC} + 0.75V dc which may overshoot to +7.0V for pulses of less than 20 ns.

Operating Modes

Mode/Pin	\overline{CE}	\overline{OE}	PGM	Ai	V _{PP}	Outputs
Read	V _{IL}	V _{IL}	X ⁽¹⁾	Ai	X	D _{OUT}
Output Disable	X	V _{IH}	X	X	X	High Z
Standby	V _{IH}	X	X	X	X ⁽⁵⁾	High Z
Rapid Program ⁽²⁾	V _{IL}	V _{IH}	V _{IL}	Ai	V _{PP}	D _{IN}
PGM Verify	V _{IL}	V _{IL}	V _{IH}	Ai	V _{PP}	D _{OUT}
PGM Inhibit	V _{IH}	X	X	X	V _{PP}	High Z
Product Identification ⁽⁴⁾	V _{IL}	V _{IL}	X	A9 = V _H ⁽³⁾ A0 = V _{IH} or V _{IL} A1 - A15 = V _{IL}	V _{CC}	Identification Code

- Notes:
1. X can be V_{IL} or V_{IH}.
 2. Refer to Programming Characteristics.
 3. V_H = 12.0 ± 0.5V.
 4. Two identifier words may be selected. All Ai inputs are held low (V_{IL}), except A9 which is set to V_H and A0 which is toggled low (V_{IL}) to select the Manufacturer's Identification word and high (V_{IH}) to select the Device Code word.
 5. Standby V_{CC} current (I_{SB}) is specified with V_{PP} = V_{CC}. V_{CC} > V_{PP} will cause a slight increase in I_{SB}.



DC and AC Operating Conditions for Read Operation

		AT27C1024					
		-45	-55	-70	-90	-12	-15
Operating Temp. (Case)	Com.	0°C - 70°C	0°C - 70°C	0°C - 70°C	0°C - 70°C	0°C - 70°C	0°C - 70°C
	Ind.	-40°C - 85°C	-40°C - 85°C	-40°C - 85°C	-40°C - 85°C	-40°C - 85°C	-40°C - 85°C
	Auto.				-40°C - 125°C	-40°C - 125°C	-40°C - 125°C
V _{CC} Power Supply		5V ± 10%	5V ± 10%	5V ± 10%	5V ± 10%	5V ± 10%	5V ± 10%

DC and Operating Characteristics for Read Operation

Symbol	Parameter	Condition	Min	Max	Units
I _{LI}	Input Load Current	V _{IN} = 0V to V _{CC}	Com., Ind.	±1	µA
			Auto.	±5	µA
I _{LO}	Output Leakage Current	V _{OUT} = 0V to V _{CC}	Com., Ind.	±5	µA
			Auto.	±10	µA
I _{PP1} ⁽²⁾	V _{PP} ⁽¹⁾ Read/Standby Current	V _{PP} = V _{CC}		10	µA
I _{SB}	V _{CC} ⁽¹⁾ Standby Current	I _{SB1} (CMOS), $\overline{CE} = V_{CC} \pm 0.3V$		100	µA
		I _{SB2} (TTL), $\overline{CE} = 2.0$ to V _{CC} + 0.5V		1	mA
I _{CC}	V _{CC} Active Current	f = 5 MHz, I _{OUT} = 0 mA, $\overline{CE} = V_{IL}$		30	mA
V _{IL}	Input Low Voltage		-0.6	0.8	V
V _{IH}	Input High Voltage		2.0	V _{CC} + 0.5	V
V _{OL}	Output Low Voltage	I _{OL} = 2.1 mA		0.4	V
V _{OH}	Output High Voltage	I _{OH} = -400 µA	2.4		V

- Notes: 1. V_{CC} must be applied simultaneously or before V_{PP} and removed simultaneously or after V_{PP}.
 2. V_{PP} may be connected directly to V_{CC}, except during programming. The supply current would then be the sum of I_{CC} and I_{PP}.

AC Characteristics for Read Operation

Symbol	Parameter	Condition	AT27C1024												Units
			-45		-55		-70		-90		-12		-15		
			Min	Max	Min	Max	Min	Max	Min	Max	Min	Max	Min	Max	
t _{ACC} ⁽³⁾	Address to Output Delay	$\overline{CE} = \overline{OE} = V_{IL}$		45		55		70		90		120		150	ns
t _{CE} ⁽²⁾	\overline{CE} to Output Delay	$\overline{OE} = V_{IL}$		45		55		70		90		120		150	ns
t _{OE} ⁽²⁾⁽³⁾	\overline{OE} to Output Delay	$\overline{CE} = V_{IL}$		20		25		25		30		35		50	ns
t _{DF} ⁽⁴⁾⁽⁵⁾	\overline{OE} or \overline{CE} High to Output Float, whichever occurred first			20		25		25		30		30		40	ns
t _{OH}	Output Hold from Address, \overline{CE} or \overline{OE} , whichever occurred first		7		7		7		0		0		0		ns

Note: 2, 3, 4, 5. - see AC Waveforms for Read Operation.

AC Waveforms for Read Operation⁽¹⁾

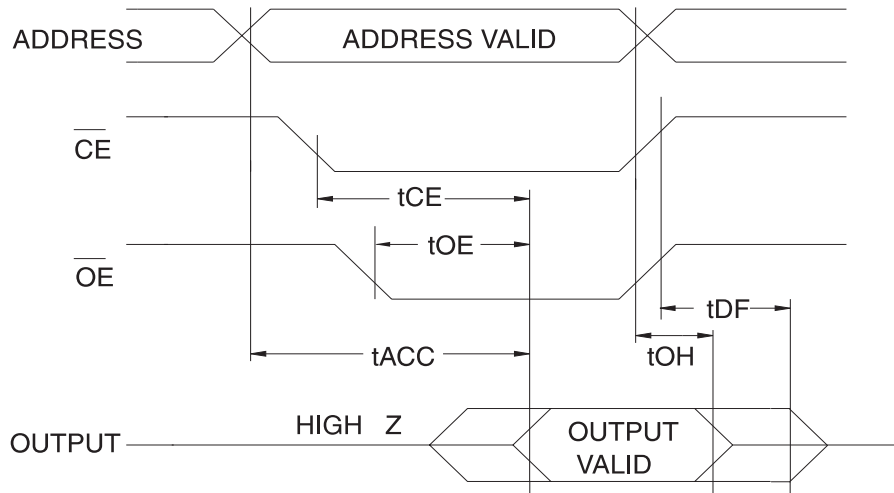

- Notes:
1. Timing measurement reference level is 1.5V for -45 and -55 devices. Input AC drive levels are $V_{IL} = 0.0V$ and $V_{IH} = 3.0V$. Timing measurement reference levels for all other speed grades are $V_{OL} = 0.8V$ and $V_{OH} = 2.0V$. Input AC drive levels are $V_{IL} = 0.45V$ and $V_{IH} = 2.4V$.
 2. \overline{OE} may be delayed up to $t_{CE} - t_{OE}$ after the falling edge of \overline{CE} without impact on t_{CE} .
 3. \overline{OE} may be delayed up to $t_{ACC} - t_{OE}$ after the address is valid without impact on t_{ACC} .
 4. This parameter is only sampled and is not 100% tested.
 5. Output float is defined as the point when data is no longer driven.

Pin Capacitance

$f = 1 \text{ MHz}$, $T = 25^\circ\text{C}$ ⁽¹⁾

Symbol	Typ	Max	Units	Conditions
C_{IN}	4	10	pF	$V_{IN} = 0V$
C_{OUT}	8	12	pF	$V_{OUT} = 0V$

Note: 1. Typical values for nominal supply voltage. This parameter is only sampled and is not 100% tested.

Input Test Waveforms and Measurement Levels



For -45 and -55 Devices Only



For -70 and slower Devices Only

Output Test Load

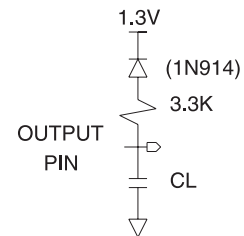

Note: $C_L = 100 \text{ pF}$ including jig capacitance except -45 and -55 devices, where $C_L = 30 \text{ pF}$.

Programming Waveforms⁽¹⁾

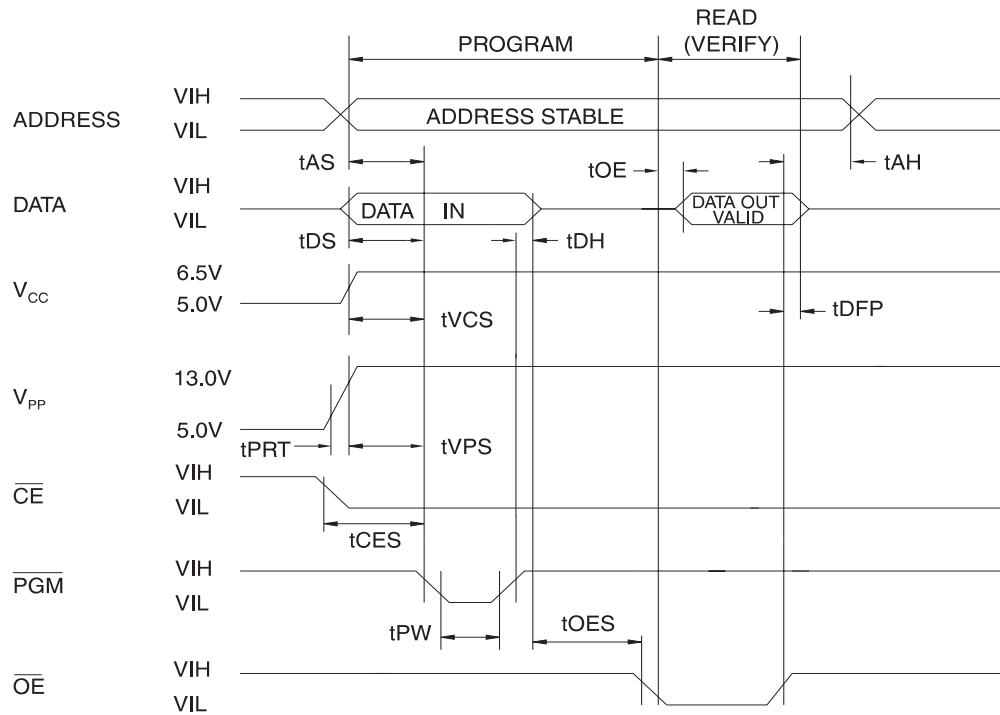

- Notes:
1. The Input Timing Reference is 0.8V for V_{IL} and 2.0V for V_{IH}.
 2. t_{OE} and t_{DFP} are characteristics of the device but must be accommodated by the programmer.
 3. When programming the AT27C1024 a 0.1 μF capacitor is required across V_{PP} and ground to suppress spurious voltage transients.

DC Programming Characteristics

T_A = 25 ± 5°C, V_{CC} = 6.5 ± 0.25V, V_{PP} = 13.0 ± 0.25V

Symbol	Parameter	Test Conditions	Limits		Units
			Min	Max	
I _{LI}	Input Load Current	V _{IN} = V _{IL} , V _{IH}		±10	μA
V _{IL}	Input Low Level		-0.6	0.8	V
V _{IH}	Input High Level		2.0	V _{CC} + 0.1	V
V _{OL}	Output Low Voltage	I _{OL} = 2.1 mA		0.4	V
V _{OH}	Output High Voltage	I _{OH} = -400 μA	2.4		V
I _{CC2}	V _{CC} Supply Current (Program and Verify)			50	mA
I _{PP2}	V _{PP} Supply Current	$\overline{CE} = \overline{PGM} = V_{IL}$		30	mA
V _{ID}	A9 Product Identification Voltage		11.5	12.5	V

AC Programming Characteristics

$T_A = 25 \pm 5^\circ\text{C}$, $V_{CC} = 6.5 \pm 0.25\text{V}$, $V_{PP} = 13.0 \pm 0.25\text{V}$

Symbol	Parameter	Test Conditions ⁽¹⁾	Limits		Units
			Min	Max	
t_{AS}	Address Setup Time	Input Rise and Fall Times (10% to 90%) 20ns	2		μs
t_{CES}	\overline{CE} Setup Time		2		μs
t_{OES}	\overline{OE} Setup Time		2		μs
t_{DS}	Data Setup Time		2		μs
t_{AH}	Address Hold Time	Input Pulse Levels 0.45V to 2.4V	0		μs
t_{DH}	Data Hold Time		2		μs
t_{DFP}	\overline{OE} High to Output Float Delay ⁽²⁾	Input Timing Reference Level 0.8V to 2.0V	0	130	ns
t_{VPS}	V_{PP} Setup Time		2		μs
t_{VCS}	V_{CC} Setup Time		2		μs
t_{PW}	\overline{PGM} Program Pulse Width ⁽³⁾	Output Timing Reference Level 0.8V to 2.0V	95	105	μs
t_{OE}	Data Valid from \overline{OE}			150	ns
t_{PRT}	V_{PP} Pulse Rise Time During Programming		50		ns

- Notes:
- V_{CC} must be applied simultaneously or before V_{PP} and removed simultaneously or after V_{PP}
 - This parameter is only sampled and is not 100% tested. Output Float is defined as the point where data is no longer driven—see timing diagram.
 - Program Pulse width tolerance is $100 \mu\text{sec} \pm 5\%$.

Atmel's 27C1024 Integrated Product Identification Code

Codes	Pins										Hex Data
	A0	O15-O8	O7	O6	O5	O4	O3	O2	O1	O0	
Manufacturer	0	0	0	0	0	1	1	1	1	0	001E
Device Type	1	0	1	1	1	1	0	0	0	1	00F1

Rapid Programming Algorithm

A 100 μs $\overline{\text{PGM}}$ pulse width is used to program. The address is set to the first location. V_{CC} is raised to 6.5V and V_{PP} is raised to 13.0V. Each address is first programmed with one 100 μs $\overline{\text{PGM}}$ pulse without verification. Then a verification / reprogramming loop is executed for each address. In the event a word fails to pass verification, up to 10 successive 100 μs pulses are applied with a verification

after each pulse. If the word fails to verify after 10 pulses have been applied, the part is considered failed. After the word verifies properly, the next address is selected until all have been checked. V_{PP} is then lowered to 5.0V and V_{CC} to 5.0V. All words are read again and compared with the original data to determine if the device passes or fails.

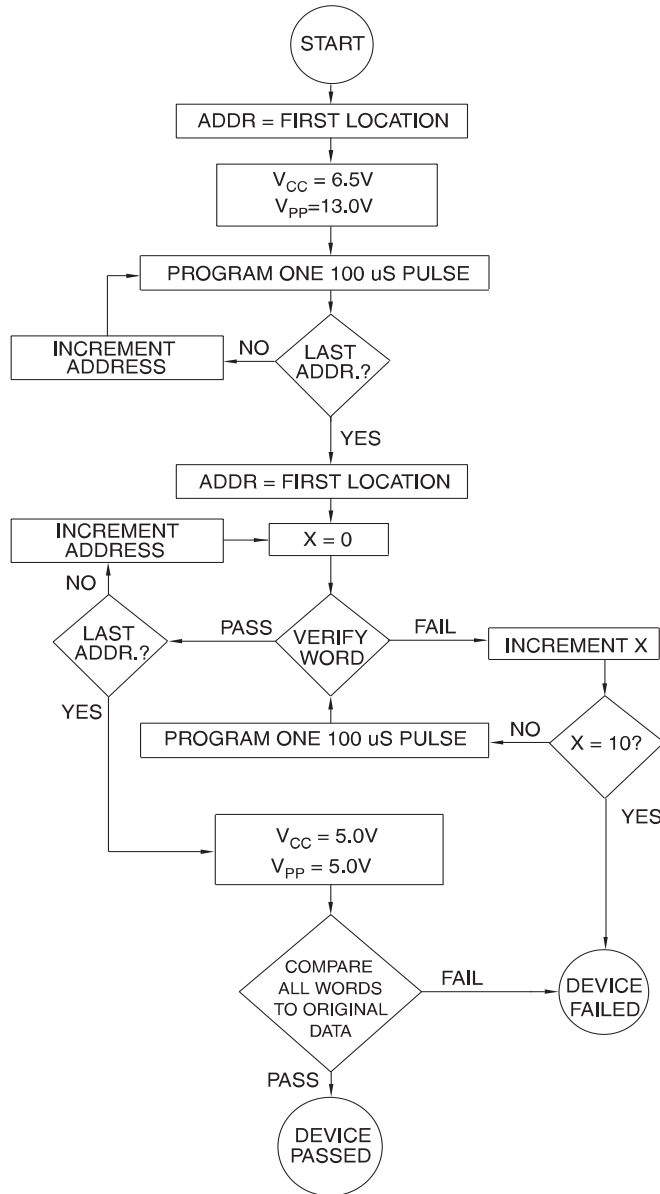

Ordering Information

t _{ACC} (ns)	I _{CC} (mA)		Ordering Code	Package	Operation Range
	Active	Standby			
45	30	0.1	AT27C1024-45JC AT27C1024-45PC AT27C1024-45VC	44J 40P6 40V	Commercial (0°C to 70°C)
	30	0.1	AT27C1024-45JI AT27C1024-45PI AT27C1024-45VI	44J 40P6 40V	Industrial (-40°C to 85°C)
55	30	0.1	AT27C1024-55JC AT27C1024-55PC AT27C1024-55VC	44J 40P6 40V	Commercial (0°C to 70°C)
	30	0.1	AT27C1024-55JI AT27C1024-55PI AT27C1024-55VI	44J 40P6 40V	Industrial (-40°C to 85°C)
70	30	0.1	AT27C1024-70JC AT27C1024-70PC AT27C1024-70VC	44J 40P6 40V	Commercial (0°C to 70°C)
	30	0.1	AT27C1024-70JI AT27C1024-70PI AT27C1024-70VI	44J 40P6 40V	Industrial (-40°C to 85°C)

(continued)

Package Type	
44J	44-Lead, Plastic J-Leaded Chip Carrier (PLCC)
40P6	40-Lead, 0.600" Wide, Plastic Dual Inline Package (PDIP)
40V	40-Lead, Plastic Thin Small Outline Package (VSOP) 10 x 14 mm



Ordering Information (Continued)

t _{ACC} (ns)	I _{CC} (mA)		Ordering Code	Package	Operation Range
	Active	Standby			
90	30	0.1	AT27C1024-90JC	44J	Commercial (0°C to 70°C)
			AT27C1024-90PC	40P6	
			AT27C1024-90VC	40V	
90	30	0.1	AT27C1024-90JI	44J	Industrial (-40°C to 85°C)
			AT27C1024-90PI	40P6	
			AT27C1024-90VI	40V	
90	30	0.1	AT27C1024-90JA	44J	Automotive (-40°C to 125°C)
			AT27C1024-90PA	40P6	
120	30	0.1	AT27C1024-12JC	44J	Commercial (0°C to 70°C)
			AT27C1024-12PC	40P6	
			AT27C1024-12VC	40V	
120	30	0.1	AT27C1024-12JI	44J	Industrial (-40°C to 85°C)
			AT27C1024-12PI	40P6	
			AT27C1024-12VI	40V	
120	30	0.1	AT27C1024-12JA	44J	Automotive (-40°C to 125°C)
			AT27C1024-12PA	40P6	
150	30	0.1	AT27C1024-15JC	44J	Commercial (0°C to 70°C)
			AT27C1024-15PC	40P6	
			AT27C1024-15VC	40V	
150	30	0.1	AT27C1024-15JI	44J	Industrial (-40°C to 85°C)
			AT27C1024-15PI	40P6	
			AT27C1024-15VI	40V	
150	30	0.1	AT27C1024-15JA	44J	Automotive (-40°C to 125°C)
			AT27C1024-15PA	40P6	

Package Type	
44J	44-Lead, Plastic J-Leaded Chip Carrier (PLCC)
40P6	40-Lead, 0.600" Wide, Plastic Dual Inline Package (PDIP)
40V	40-Lead, Plastic Thin Small Outline Package (VSOP) 10 x 14 mm

Packaging Information

44J, 44-Lead, Plastic J-Leaded Chip Carrier (PLCC)
 Dimensions in Inches and (Millimeters)
 JEDEC STANDARD MS-018 AC

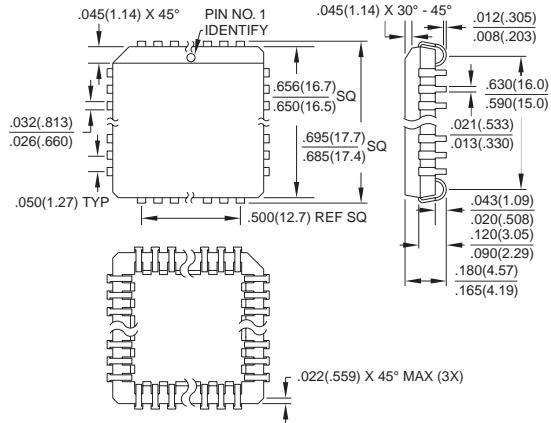

40P6, 40-Lead, 0.600" Wide, Plastic Dual Inline Package (PDIP)
 Dimensions in Inches and (Millimeters)
 JEDEC STANDARD MS-011 AC

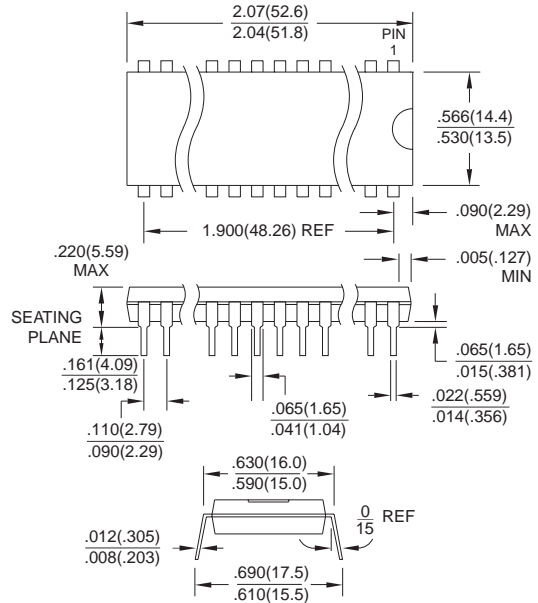

40V, 40-Lead, Plastic Thin Small Outline Package (TSOP)
 Dimensions in Millimeters and (Inches)
 JEDEC OUTLINE MO-142 CA

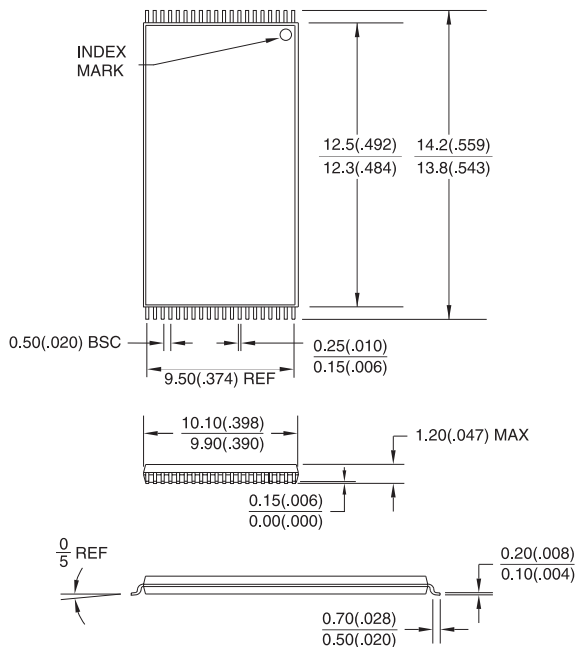



Atmel Headquarters

Corporate Headquarters
2325 Orchard Parkway
San Jose, CA 95131
TEL (408) 441-0311
FAX (408) 487-2600

Europe

Atmel U.K., Ltd.
Coliseum Business Centre
Riverside Way
Camberley, Surrey GU15 3YL
England
TEL (44) 1276-686677
FAX (44) 1276-686697

Asia

Atmel Asia, Ltd.
Room 1219
Chinachem Golden Plaza
77 Mody Road
Tsimshatsui East
Kowloon, Hong Kong
TEL (852) 27219778
FAX (852) 27221369

Japan

Atmel Japan K.K.
Tonetsu Shinkawa Bldg., 9F
1-24-8 Shinkawa
Chuo-ku, Tokyo 104-0033
Japan
TEL (81) 3-3523-3551
FAX (81) 3-3523-7581

Atmel Operations

Atmel Colorado Springs
1150 E. Cheyenne Mtn. Blvd.
Colorado Springs, CO 80906
TEL (719) 576-3300
FAX (719) 540-1759

Atmel Rousset

Zone Industrielle
13106 Rousset Cedex, France
TEL (33) 4 42 53 60 00
FAX (33) 4 42 53 60 01

Fax-on-Demand

North America:
1-(800) 292-8635
International:
1-(408) 441-0732

e-mail

literature@atmel.com

Web Site

<http://www.atmel.com>

BBS

1-(408) 436-4309

© Atmel Corporation 1998.

Atmel Corporation makes no warranty for the use of its products, other than those expressly contained in the Company's standard warranty which is detailed in Atmel's Terms and Conditions located on the Company's website. The Company assumes no responsibility for any errors which may appear in this document, reserves the right to change devices or specifications detailed herein at any time without notice, and does not make any commitment to update the information contained herein. No licenses to patents or other intellectual property of Atmel are granted by the Company in connection with the sale of Atmel products, expressly or by implication. Atmel's products are not authorized for use as critical components in life support devices or systems.

Marks bearing ® and/or ™ are registered trademarks and trademarks of Atmel Corporation.

Terms and product names in this document may be trademarks of others.



Printed on recycled paper.

0019J-07/98/xM

Looking for pricing, stock, or lifecycle information?

Click below to explore more details on WIN SOURCE:

 [View AT27C1024-55JI on WIN SOURCE](#)

 [Atmel Information](#)

Optimize Your Supply Chain with WIN SOURCE Solutions

-  Global Sourcing Solution
-  Obsolete Management
-  Cost Control Management
-  Shortage Management
-  Alternative Solution
-  Excess Inventory Management