



**THE DATASHEET OF
SMF17AT1G**



SMF5.0AT1G Series, SZSMF5.0AT1G Series

200 W Transient Voltage Suppressor SOD-123 Flat Lead Package

The SMF5.0AT1G Series is designed to protect voltage sensitive components from high voltage, high energy transients. Excellent clamping capability, high surge capability, low zener impedance and fast response time. Because of its small size, it is ideal for use in cellular phones, portable devices, business machines, power supplies and many other industrial/consumer applications.

Features

- Stand-off Voltage: 5 – 58 Volts
- Peak Power – 200 Watts @ 1 ms (SMF5.0A – SMF58A)
- Low Leakage
- Response Time is Typically < 1 ns
- ESD Rating of Class 3 (> 16 kV) per Human Body Model
- ESD Rating of Level 4 (8 kV Contact Discharge) per IEC61000-4-2
- EFT (Electrical Fast Transients) Rating of 40 A per IEC61000-4-4
- Low Profile – Maximum Height of 1.0 mm
- Small Footprint – Footprint Area of 8.45 mm²
- Supplied in 8 mm Tape and Reel – 3,000 Units per Reel
- Cathode Indicated by Polarity Band
- Lead Orientation in Tape: Cathode Lead to Sprocket Holes
- SZ Prefix for Automotive and Other Applications Requiring Unique Site and Control Change Requirements; AEC-Q101 Qualified and PPAP Capable
- These Devices are Pb-Free and are RoHS Compliant*

Mechanical Characteristics:

CASE: Void-free, transfer-molded, thermosetting plastic
Epoxy Meets UL 94 V-0

LEAD FINISH: 100% Matte Sn (Tin)

MOUNTING POSITION: Any

QUALIFIED MAX REFLOW TEMPERATURE: 260°C

Device Meets MSL 1 Requirements

*For additional information on our Pb-Free strategy and soldering details, please download the ON Semiconductor Soldering and Mounting Techniques Reference Manual, SOLDERRM/D.



ON Semiconductor®

<http://onsemi.com>

**PLASTIC SURFACE MOUNT
ZENER OVERVOLTAGE
TRANSIENT SUPPRESSOR
5 – 58 VOLTS
200 WATT PEAK POWER**

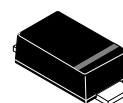

SOD-123FL
CASE 498

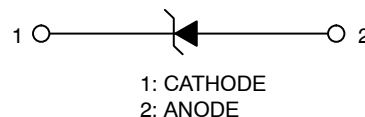

MARKING DIAGRAM

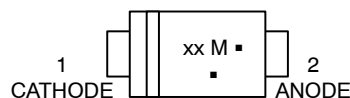

xx = Device Code (Refer to page 3)
M = Date Code
▪ = Pb-Free Package

(Note: Microdot may be in either location)

ORDERING INFORMATION

| Device | Package | Shipping† |
|--------------|------------------------|------------------------|
| SMFxxxAT1G | SOD-123FL (Pb-Free) | 3,000 / Tape & Reel |
| SZSMFxxxAT1G | SOD-123FL (Pb-Free) | 3,000 / Tape & Reel |

†For information on tape and reel specifications, including part orientation and tape sizes, please refer to our Tape and Reel Packaging Specifications Brochure, BRD8011/D.

DEVICE MARKING INFORMATION

See specific marking information in the device marking column of the Electrical Characteristics table on page 3 of this data sheet.

SMF5.0AT1G Series, SZSMF5.0AT1G Series

MAXIMUM RATINGS

| Rating | Symbol | Value | Unit |
|--|------------------------------|----------------|---|
| Maximum P_{pk} Dissipation (PW=10/1000 μ s) (Note 1) SMF5.0A – SMF58A | P_{pk} | 200 | W |
| Maximum P_{pk} Dissipation @ $T_A = 25^\circ\text{C}$, (PW=8/20 μ s) (Note 2) | P_{pk} | 1000 | W |
| DC Power Dissipation @ $T_A = 25^\circ\text{C}$ (Note 3) Derate above 25°C Thermal Resistance, Junction-to-Ambient (Note 3) | P_D $R_{\theta JA}$ | 385 325 | mW mW/ $^\circ\text{C}$ $^\circ\text{C}/\text{W}$ |
| Thermal Resistance, Junction-to-Lead (Note 3) | $R_{\theta Jcathode}$ | 26 | $^\circ\text{C}/\text{W}$ |
| Operating and Storage Temperature Range | T_J, T_{stg} | -55 to +150 | $^\circ\text{C}$ |

Stresses exceeding Maximum Ratings may damage the device. Maximum Ratings are stress ratings only. Functional operation above the Recommended Operating Conditions is not implied. Extended exposure to stresses above the Recommended Operating Conditions may affect device reliability.

1. Non-repetitive current pulse at $T_A = 25^\circ\text{C}$, per waveform of Figure 2.
2. Non-repetitive current pulse at $T_A = 25^\circ\text{C}$, per waveform of Figure 3.
3. Mounted with recommended minimum pad size, DC board FR-4.

ELECTRICAL CHARACTERISTICS ($T_A = 25^\circ\text{C}$ unless otherwise noted, $V_F = 3.5\text{ V Max. @ } I_F$ (Note 4) = 12 A)

| Symbol | Parameter |
|-----------|---|
| I_{PP} | Maximum Reverse Peak Pulse Current |
| V_C | Clamping Voltage @ I_{PP} |
| V_{RWM} | Working Peak Reverse Voltage |
| I_R | Maximum Reverse Leakage Current @ V_{RWM} |
| V_{BR} | Breakdown Voltage @ I_T |
| I_T | Test Current |
| I_F | Forward Current |
| V_F | Forward Voltage @ I_F |

4. 1/2 sine wave (or equivalent square wave), PW = 8.3 ms, duty cycle = 4 pulses per minute maximum.

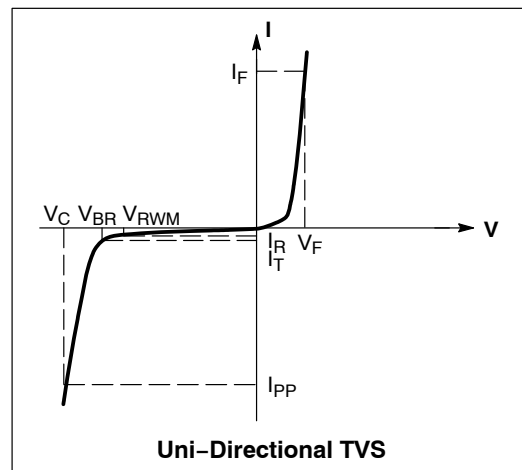

SMF5.0AT1G Series, SZSMF5.0AT1G Series

ELECTRICAL CHARACTERISTICS ($T_L = 30^\circ\text{C}$ unless otherwise noted, $V_F = 1.25$ Volts @ 200 mA)

| Device* | Marking | V_{RWM} (V) | V_{BR} @ I_T (V) (Note 6) | | | I_T | I_R @ V_{RWM} | $V_{C(Max)}$ | $I_{PP(Max)}$ (A) |
|----------|---------|---------------|-------------------------------|-------|------|-------|-------------------|--------------|-------------------|
| | | (Note 5) | Min | Nom | Max | (mA) | (μA) | (V) | (Note 7) |
| SMF5.0AG | KE | 5 | 6.4 | 6.7 | 7 | 10 | 400 | 9.2 | 21.7 |
| SMF6.0AG | KG | 6 | 6.67 | 7.02 | 7.37 | 10 | 400 | 10.3 | 19.4 |
| SMF6.5AG | KK | 6.5 | 7.22 | 7.6 | 7.98 | 10 | 250 | 11.2 | 17.9 |
| SMF7.0AG | KM | 7 | 7.78 | 8.2 | 8.6 | 10 | 100 | 12 | 16.7 |
| SMF7.5AG | KP | 7.5 | 8.33 | 8.77 | 9.21 | 1 | 50 | 12.9 | 15.5 |
| SMF8.0AG | KR | 8 | 8.89 | 9.36 | 9.83 | 1 | 25 | 13.6 | 14.7 |
| SMF9.0AG | KV | 9 | 10 | 10.55 | 11.1 | 1 | 5 | 15.4 | 13.0 |
| SMF10AG | KX | 10 | 11.1 | 11.7 | 12.3 | 1 | 2.5 | 17 | 11.8 |
| SMF11AG | KZ | 11 | 12.2 | 12.85 | 13.5 | 1 | 2.5 | 18.2 | 11.0 |
| SMF12AG | LE | 12 | 13.3 | 14 | 14.7 | 1 | 2.5 | 19.9 | 10.1 |
| SMF13AG | LG | 13 | 14.4 | 15.15 | 15.9 | 1 | 1 | 21.5 | 9.3 |
| SMF14AG | LK | 14 | 15.6 | 16.4 | 17.2 | 1 | 1 | 23.2 | 8.6 |
| SMF15AG | LM | 15 | 16.7 | 17.6 | 18.5 | 1 | 1 | 24.4 | 8.2 |
| SMF18AG | LT | 18 | 20 | 21 | 22.1 | 1 | 1 | 29.2 | 6.8 |
| SMF20AG | LV | 20 | 22.2 | 23.35 | 24.5 | 1 | 1 | 32.4 | 6.2 |
| SMF22AG | LX | 22 | 24.4 | 25.6 | 26.9 | 1 | 1 | 35.5 | 5.6 |
| SMF24AG | LZ | 24 | 26.7 | 28.1 | 29.5 | 1 | 1 | 38.9 | 5.1 |
| SMF26AG | ME | 26 | 28.9 | 30.4 | 31.9 | 1 | 1 | 42.1 | 4.8 |
| SMF28AG | MG | 28 | 31.1 | 32.8 | 34.4 | 1 | 1 | 45.4 | 4.4 |
| SMF30AG | MK | 30 | 33.3 | 35.1 | 36.8 | 1 | 1 | 48.4 | 4.1 |
| SMF33AG | MM | 33 | 36.7 | 38.7 | 40.6 | 1 | 1 | 53.3 | 3.8 |
| SMF36AG | MP | 36 | 40 | 42.1 | 44.2 | 1 | 1 | 58.1 | 3.4 |
| SMF48AG | MX | 48 | 53.3 | 56.1 | 58.9 | 1 | 1 | 77.4 | 2.6 |
| SMF51AG | MZ | 51 | 56.7 | 59.7 | 62.7 | 1 | 1 | 82.4 | 2.4 |
| SMF58AG | NG | 58 | 64.4 | 67.8 | 71.2 | 1 | 1 | 93.6 | 2.1 |

5. A transient suppressor is normally selected according to the Working Peak Reverse Voltage (V_{RWM}) which should be equal to or greater than the DC or continuous peak operating voltage level.

6. V_{BR} measured at pulse test current I_T at ambient temperature of 25°C .

7. Surge current waveform per Figure 2 and derate per Figure 3.

*Include SZ-prefix devices where applicable.

SMF5.0AT1G Series, SZSMF5.0AT1G Series

TYPICAL PROTECTION CIRCUIT

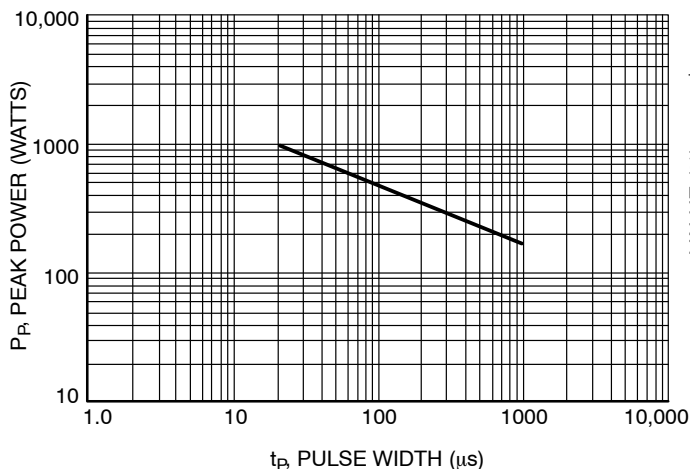
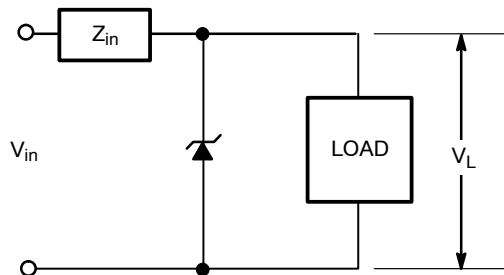

Figure 1. Pulse Rating Curve

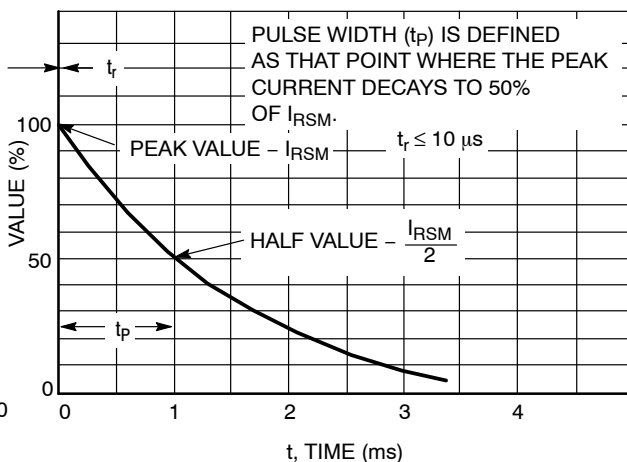

Figure 2. 10 X 1000 μ s Pulse Waveform

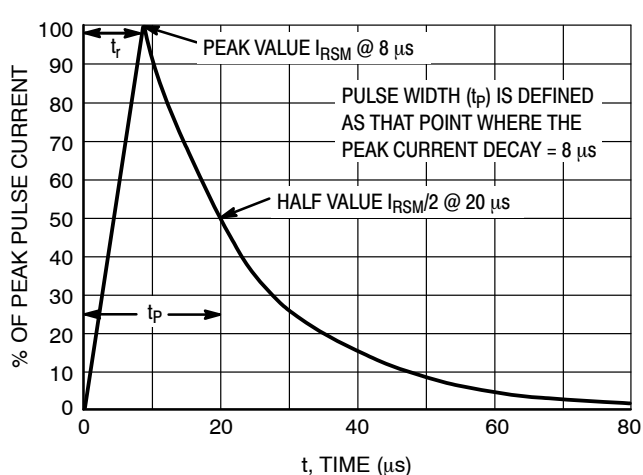

Figure 3. 8 X 20 μ s Pulse Waveform

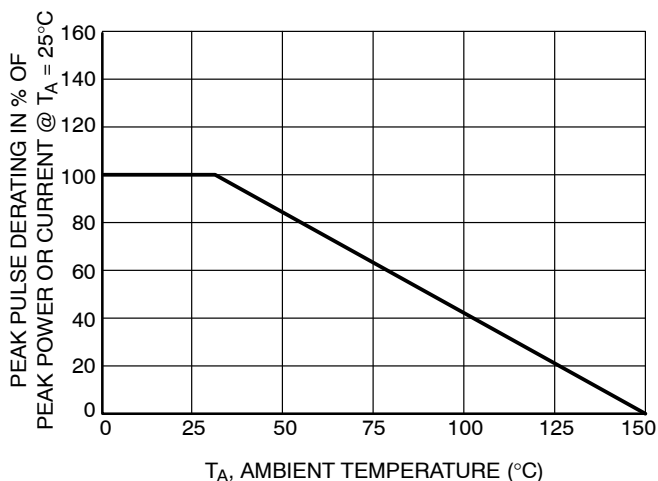

Figure 4. Pulse Derating Curve

SMF5.0AT1G Series, SZSMF5.0AT1G Series

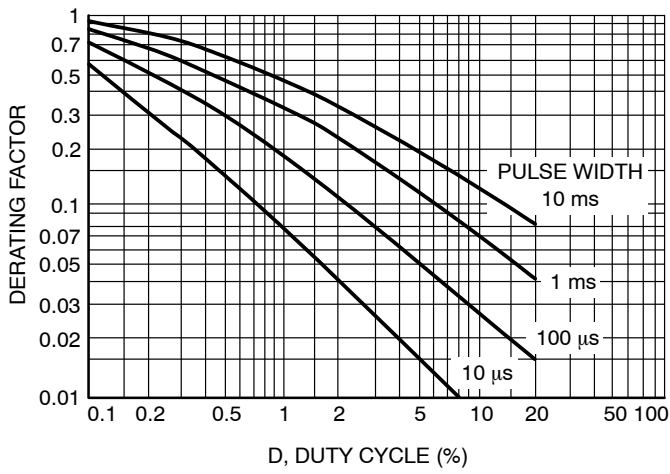

Figure 5. Typical Derating Factor for Duty Cycle

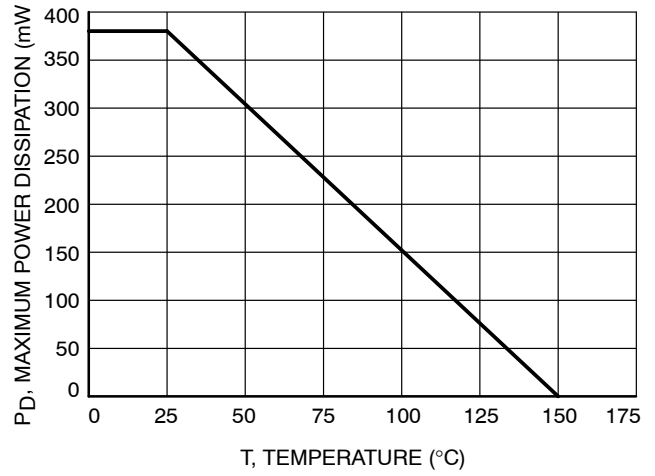

Figure 6. Steady State Power Derating

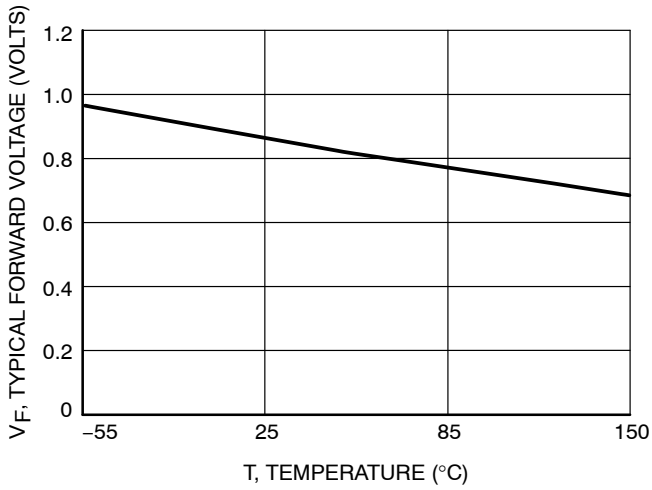

Figure 7. Forward Voltage

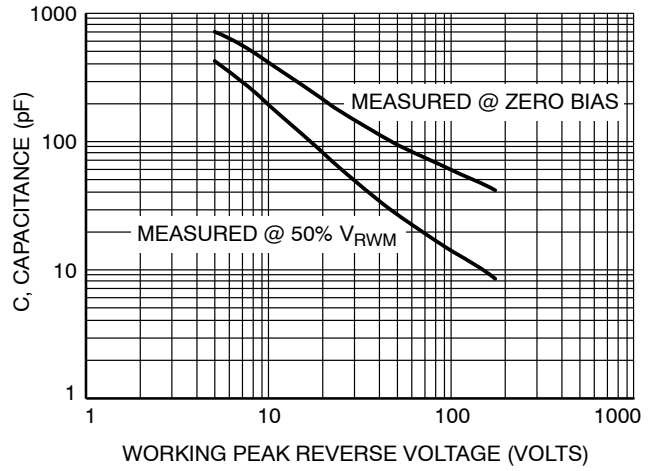
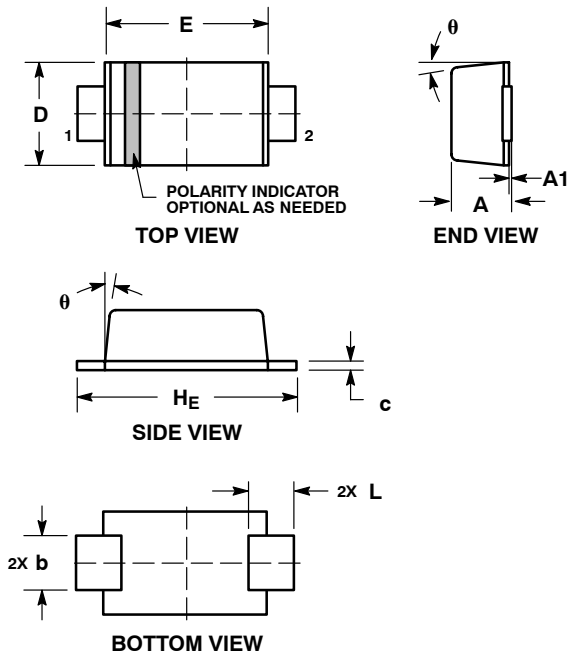

Figure 8. Capacitance versus Working Peak Reverse Voltage

SMF5.0AT1G Series, SZSMF5.0AT1G Series

PACKAGE DIMENSIONS

SOD-123FL
CASE 498
ISSUE D



NOTES:

1. DIMENSIONING AND TOLERANCING PER ANSI Y14.5M, 1982.
2. CONTROLLING DIMENSION: MILLIMETER.
3. DIMENSIONS A AND B DO NOT INCLUDE MOLD FLASH.
4. DIMENSIONS D AND J ARE TO BE MEASURED ON FLAT SECTION OF THE LEAD: BETWEEN 0.10 AND 0.25 MM FROM THE LEAD TIP.

| DIM | MILLIMETERS | | | INCHES | | |
|-----|-------------|------|------|--------|-------|-------|
| | MIN | NOM | MAX | MIN | NOM | MAX |
| A | 0.90 | 0.95 | 0.98 | 0.035 | 0.037 | 0.039 |
| A1 | 0.00 | 0.05 | 0.10 | 0.000 | 0.002 | 0.004 |
| b | 0.70 | 0.90 | 1.10 | 0.028 | 0.035 | 0.043 |
| c | 0.10 | 0.15 | 0.20 | 0.004 | 0.006 | 0.008 |
| D | 1.50 | 1.65 | 1.80 | 0.059 | 0.065 | 0.071 |
| E | 2.50 | 2.70 | 2.90 | 0.098 | 0.106 | 0.114 |
| L | 0.55 | 0.75 | 0.95 | 0.022 | 0.030 | 0.037 |
| HE | 3.40 | 3.60 | 3.80 | 0.134 | 0.142 | 0.150 |
| θ | 0° | - | 8° | 0° | - | 8° |

RECOMMENDED SOLDERING FOOTPRINT*

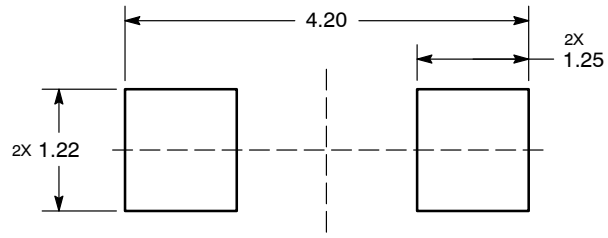

*For additional information on our Pb-Free strategy and soldering details, please download the ON Semiconductor Soldering and Mounting Techniques Reference Manual, SOLDERRM/D.

ON Semiconductor and are registered trademarks of Semiconductor Components Industries, LLC (SCILLC). SCILLC owns the rights to a number of patents, trademarks, copyrights, trade secrets, and other intellectual property. A listing of SCILLC's product/patent coverage may be accessed at www.onsemi.com/site/pdf/Patent-Marking.pdf. SCILLC reserves the right to make changes without further notice to any products herein. SCILLC makes no warranty, representation or guarantee regarding the suitability of its products for any particular purpose, nor does SCILLC assume any liability arising out of the application or use of any product or circuit, and specifically disclaims any and all liability, including without limitation special, consequential or incidental damages. "Typical" parameters which may be provided in SCILLC data sheets and/or specifications can and do vary in different applications and actual performance may vary over time. All operating parameters, including "Typicals" must be validated for each customer application by customer's technical experts. SCILLC does not convey any license under its patent rights nor the rights of others. SCILLC products are not designed, intended, or authorized for use as components in systems intended for surgical implant into the body, or other applications intended to support or sustain life, or for any other application in which the failure of the SCILLC product could create a situation where personal injury or death may occur. Should Buyer purchase or use SCILLC products for any such unintended or unauthorized application, Buyer shall indemnify and hold SCILLC and its officers, employees, subsidiaries, affiliates, and distributors harmless against all claims, costs, damages, and expenses, and reasonable attorney fees arising out of, directly or indirectly, any claim of personal injury or death associated with such unintended or unauthorized use, even if such claim alleges that SCILLC was negligent regarding the design or manufacture of the part. SCILLC is an Equal Opportunity/Affirmative Action Employer. This literature is subject to all applicable copyright laws and is not for resale in any manner.

PUBLICATION ORDERING INFORMATION

LITERATURE FULFILLMENT:
Literature Distribution Center for ON Semiconductor
P.O. Box 5163, Denver, Colorado 80217 USA
Phone: 303-675-2175 or 800-344-3860 Toll Free USA/Canada
Fax: 303-675-2176 or 800-344-3867 Toll Free USA/Canada
Email: orderlit@onsemi.com

N. American Technical Support: 800-282-9855 Toll Free
USA/Canada
Europe, Middle East and Africa Technical Support:
Phone: 421 33 790 2910
Japan Customer Focus Center
Phone: 81-3-5817-1050

ON Semiconductor Website: www.onsemi.com
Order Literature: <http://www.onsemi.com/orderlit>
For additional information, please contact your local Sales Representative

Looking for pricing, stock, or lifecycle information?

Click below to explore more details on WIN SOURCE:

 [View SMF17AT1G on WIN SOURCE](#)

 [ON Semiconductor](#) Information

Optimize Your Supply Chain with WIN SOURCE Solutions

-  Global Sourcing Solution
-  Obsolete Management
-  Cost Control Management
-  Shortage Management
-  Alternative Solution
-  Excess Inventory Management