

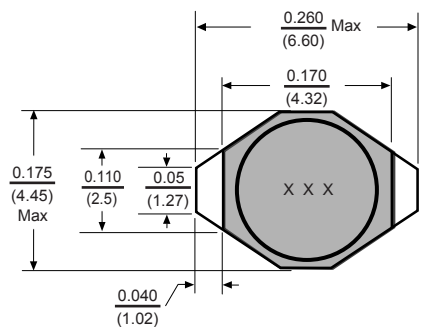

**THE DATASHEET OF
PCI20-220M-RC**



PCI20 Power Chip Inductors



Dimensions: $\frac{\text{Inches}}{\text{(mm)}}$

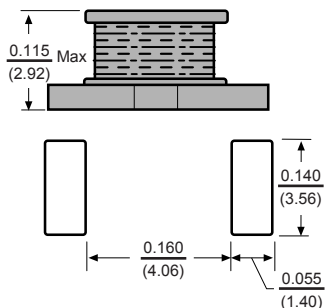

Features

- Ultraminiature foot print for high density mounting
- High current rating for their small size
- High energy storage with low DCR
- Designed with high heat resistant materials for reflow operation
- Flat top for pick and place assembly
- Non standard values available

Electrical

Inductance Range: 1.0 μ h to 1000 μ h.

Tolerance: \pm 20% over the entire inductance range.

Test Frequency: Inductance measured at 100KHz, 0.1 Vrms.

Operating Temp. Range: -40° to +85°C.

Inductance Drop: 10% typical at Isat.

Temperature Rise: $\Delta T=15^{\circ}\text{C}$ rise typical at Irms.

Physical

Marking: EIA Inductance Code

Packaging: 750 pieces per 7 inch reel.
2500 pieces per 13 inch reel.

Allied Part Number	Inductance (μ h)	Tolerance (%)	SRF MHz. TYP.	DCR Max. (Ω)	Isat (A)	Irms (A)
PCI20-1R0M-RC	1.0	20	130	0.05	2.90	2.90
PCI20-1R5M-RC	1.5	20	115	0.05	2.60	2.80
PCI20-2R2M-RC	2.2	20	90	0.07	2.30	2.40
PCI20-3R3M-RC	3.3	20	70	0.08	2.00	2.00
PCI20-4R7M-RC	4.7	20	50	0.09	1.50	1.50
PCI20-5R6M-RC	5.6	20	47	0.11	1.30	1.40
PCI20-6R8M-RC	6.8	20	45	0.13	1.20	1.40
PCI20-100M-RC	10	20	35	0.16	1.10	1.10
PCI20-150M-RC	15	20	30	0.23	0.90	1.20
PCI20-220M-RC	22	20	20	0.37	0.70	0.80
PCI20-330M-RC	33	20	15	0.51	0.58	0.60
PCI20-470M-RC	47	20	14	0.64	0.50	0.50
PCI20-680M-RC	68	20	11	0.86	0.40	0.40
PCI20-101M-RC	100	20	9.0	1.27	0.31	0.30
PCI20-151M-RC	150	20	6.0	2.00	0.27	0.25
PCI20-221M-RC	220	20	5.5	3.11	0.22	0.20
PCI20-331M-RC	330	20	5.0	3.80	0.18	0.16
PCI20-471M-RC	470	20	4.0	5.06	0.16	0.15
PCI20-681M-RC	680	20	3.0	9.20	0.14	0.12
PCI20-102M-RC	1000	20	2.0	13.8	0.10	0.07

All specifications subject to change without notice.

Looking for pricing, stock, or lifecycle information?

Click below to explore more details on WIN SOURCE:

- ⊖ [View PCI20-220M-RC on WIN SOURCE](#)
- ⊖ [Allied Components International](#) Information

Optimize Your Supply Chain with WIN SOURCE Solutions

- ✓ Global Sourcing Solution
- ✓ Obsolete Management
- ✓ Cost Control Management
- ✓ Shortage Management
- ✓ Alternative Solution
- ✓ Excess Inventory Management