



**THE DATASHEET OF
GCM32ER70J476ME19L**



Chip Multilayer Ceramic Capacitors for Automotive



2017



EU RoHS Compliant

- All the products in this catalog comply with EU RoHS.
- EU RoHS is "the European Directive 2011/65/EU on the Restriction of the Use of Certain Hazardous Substances in Electrical and Electronic Equipment."
- For more details, please refer to our web page, "Murata's Approach for EU RoHS" (<http://www.murata.com/en-eu/support/compliance/rohs>).

Contents

Product specifications are as of May 2017.

Explanation of Symbols in This Catalog	p2	
Selection Guide for Capacitors	p3	
Catalog Information	p4	
Part Numbering	p5	
Capacitance Table	p8	
		Cap. Table
<hr/>		
AEC-Q200 Compliant Chip Multilayer Ceramic Capacitors for Infotainment		
GRT Series	p23	p9
<hr/>		
Chip Multilayer Ceramic Capacitors for Automotive		
GCM Series	p29	p12
<hr/>		
High Effective Capacitance & High Ripple Current Chip Multilayer Ceramic Capacitors for Automotive		
GC3 Series	p37	p14
<hr/>		
Soft Termination Chip Multilayer Ceramic Capacitors for Automotive		
GCJ Series	p39	p16
<hr/>		
MLSC Design Chip Multilayer Ceramic Capacitors for Automotive		
GCD Series	p45	p18
<hr/>		
Soft Termination MLSC Design Chip Multilayer Ceramic Capacitors for Automotive		
GCE Series	p47	p18
<hr/>		
Very Large Current 3 Terminals Low ESL Chip Multilayer Ceramic Capacitors for Automotive (EMIFIL®)		
NFM Series	p49	p18
<hr/>		
Metal Terminal Type Multilayer Ceramic Capacitors for Automotive		
KCM Series	p51	p19
<hr/>		
High Effective Capacitance & High Allowable Ripple Current Metal Terminal Type Multilayer Ceramic Capacitors for Automotive		
KC3 Series	p54	p19
<hr/>		
Safety Standard Certified Metal Terminal Type Multilayer Ceramic Capacitors for Automotive		
KCA Series	p57	p19
<hr/>		
AgPd Termination Conductive Glue Mounting Chip Multilayer Ceramic Capacitors for Automotive		
GCG Series	p60	p19
<hr/>		
⚠Caution/Notice	p65	
Web page SimSurfing	p87	
Introduction	p88	

Please check the MURATA website (<http://www.murata.com/>) if you cannot find a part number in this catalog.

Explanation of Symbols in This Catalog



Links are provided to the latest information from the PDF version of the catalog, which is available on the web.

General	For applications that do not require the particular reliability such as the general equipment
Info-tainment	Infotainment for Automotive The product for entertainment equipment like car navigations, car audios, and body control equipment like wipers, power windows.
Power-train	Powertrain/Safety for Automotive Product used for applications (running, turning, stopping and safety devices) which particularly concern human life, such as in devices for automobiles.
Medical Device	Medical-grade products for Implanted Medical Devices These products are intended for use in implanted medical devices such as cardiac pacemakers, cochlear implants, insulin pumps and gastric electrostimulators. They are suitable for use in non-critical circuits. *1 *1 Non-critical circuits This term refers to circuits in implanted medical devices that are not directly linked to life support, i.e. circuits that will not directly endanger the life of the patient should the functionality of the device be reduced or halted by failure of the circuit.
AEC-Q200	AEC-Q200 compliant product
Safety standard	Safety Standard Certified Product Products that acquired safety standard certification IEC60384-14 and products based on the Electrical Appliance and Material Safety Law of Japan.
High Q	Low dissipation for high frequency By devising ceramic materials and electrode materials, low dissipation is achieved in frequency bands of VHF, UHF and microwave or beyond.
Low ESL	Low inductance This capacitor is designed so that the parasitic inductance component (ESL) that the capacitor has on the high frequency side becomes lower.
Fail safe	Fail safe product This capacitor is designed to prevent failures as much as possible by short mode.
Deflecting crack	Product resistant to deflection cracking This capacitor is designed to prevent failures as much as possible by short mode caused by cracking when there is board deflection.
Soldering crack	Product with solder cracking suppression This capacitor is configured with metal terminals and leads connected to the chip. The metal terminals and leads relieve the stress from expansion and contraction of the solder, to suppress solder cracking.
Anti-noise	Product suitable for acoustic noise reduction and low distortion This product suppresses acoustic noise, which occurs when a ceramic capacitor is used, by devising the materials and configuration.
Effective Cap	No DC bias characteristics Polymer capacitor is no capacitance change with DC bias due to aluminum oxidized film for dielectric.
EMI FIL®	Low-inductance product suitable for noise suppression. This product has extremely low ESL and is suitable for suppression of noise, including high frequencies. This product can also be used as a low-ESL, high-performance bypass capacitor.
Limited to conductive glue mounting	Limited to Conductive Glue Mounting Since silver palladium is used for the external electrodes, the capacitor can be mounted by conductive adhesive.

Derating 1
 This product is suitable when a voltage continuously applied to a capacitor in an operating circuit, is used below (derated) the rated voltage of the capacitor. This model guarantees the test conditions in the endurance test, at a rated voltage x 100% at the maximum operating temperature. A reliability assurance level equivalent to a common product can be secured, by using this product within the voltage and temperature derated conditions recommended in the figure below.

D1
 Derating 1

Recommended Conditions of the Derating Operating Voltage and Temperature

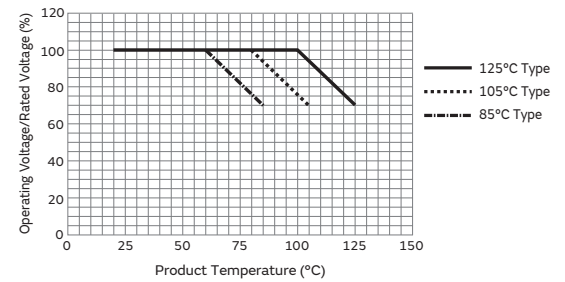

Derating 2
 When the product temperature exceeds 105°C, please use this product within the voltage and temperature derated conditions in the figure below.

D2
 Derating 2

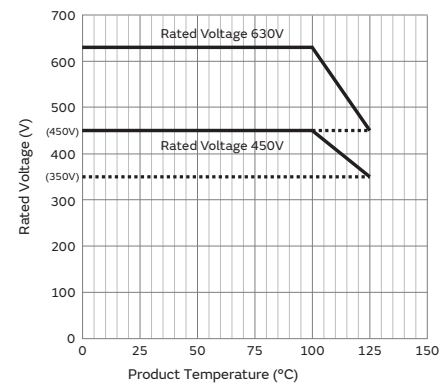

D3
 Derating 3

Derating 3
 Please apply the derating curve according to the operating temperature.
 Please refer to detailed specifications sheet for details.

D4
 Derating 4

Derating 4
 When the product temperature exceeds 125°C, please use this product within the voltage and temperature derated conditions in the figure below.

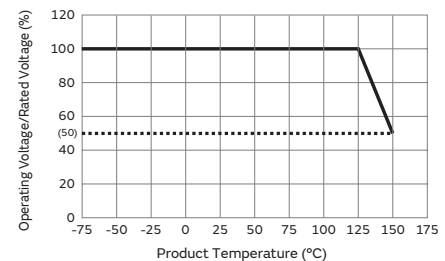

D5
 Derating 5

Derating 5
 Please apply the rated voltage derating over 150°C. Please refer to detailed specifications sheet for details.

Selection Guide for Capacitors

Infotainment for automotive	
Info-tainment AEC-Q200	SMD
	Solder mounting
	Chip type
	GRT P23

Powertrain/Safety for automotive	
Power-train AEC-Q200	SMD
	Solder mounting
	Chip type
	GCM P29
	GC3 Anti-noise Deflecting crack Soldering crack High effective capacitance & high ripple current P37
	GCJ Fail safe Deflecting crack Soft termination P39
	GGM Water Resistant WEB
	GCQ High Q WEB
	GCD Fail safe Deflecting crack MLSC design P45
	GCE Fail safe Deflecting crack Soft termination MLSC design P47
	GGD Fail safe Deflecting crack Water Resistant MLSC design WEB
	NFM Low ESL 3 terminals P49
	Metal terminal type
	KCM Anti-noise Deflecting crack Soldering crack P51
	KC3 Anti-noise Deflecting crack Soldering crack High effective capacitance & high ripple current P54
	KCA Safety standard Anti-noise Deflecting crack Soldering crack P57
	Limited to Conductive Glue Mounting
<div style="border: 1px solid black; padding: 2px; font-size: 8px;"> Limited to conductive glue mounting </div>	Chip type
	GCB Deflecting crack Soldering crack Ni plating + Pd plating termination conductive glue mounting WEB
	GCG Deflecting crack Soldering crack AgPd termination conductive glue mounting P60
	Lead type
	Solder mounting
	RCE Anti-noise Deflecting crack Soldering crack WEB
	RHE Anti-noise Deflecting crack Soldering crack 150°C operation leaded WEB
	RHS Anti-noise Deflecting crack Soldering crack 200°C operation leaded WEB
	DE6 Safety standard WEB

Medical-grade products for implanted medical devices	
Medical Device	SMD
	Solder mounting
	Chip type
	GCH WEB

For general	
General	SMD
	Solder mounting
	Chip type
	GRM WEB
	GRM For LCD backlight inverter circuit only WEB
	GR3 Anti-noise High effective capacitance & high ripple current WEB
	GRJ Deflecting crack Soft termination WEB
	GXM Water Resistant WEB
	GR4 For information devices only WEB
	GR7 For camera flash circuit only WEB
	GJM High Q WEB
	GQM High Q High power WEB
	GA2 Based on the Electrical Appliance and Material Safety Law of Japan WEB
	GA3 Safety standard WEB
	LLL Low ESL LW reversed WEB
	LLA Low ESL 8 terminals WEB
	LLM Low ESL 10 terminals WEB
	LLR Low ESL LW reversed controlled ESR WEB
	NFM Low ESL 3 terminals WEB
	GJ4 Anti-noise Low distortion WEB
	GJ8 Anti-noise Low acoustic noise WEB
	On interposer board
	ZRA Anti-noise WEB
	ZRB Anti-noise WEB
	Metal terminal type
	KRM Anti-noise Deflecting crack Soldering crack WEB
	KR3 Anti-noise Deflecting crack Soldering crack High effective capacitance & high ripple current WEB
	Resin molding SMD type
	DK1 Safety standard WEB
	Wire bonding mounting
Bonding	Chip type
	GMA Microchip WEB
	GMD WEB
	Lead type
	Solder mounting
	RDE Anti-noise Deflecting crack Soldering crack WEB
	DEH High temperature low loss WEB
	DEA High temperature Class 1 WEB
	DEB Class 2 WEB
	DEC WEB
	DEF For LCD backlight inverter circuit only WEB
	DHR Ultra-high-voltage Deflecting crack Soldering crack WEB
	DEJ Based on the Electrical Appliance and Material Safety Law of Japan WEB
	DE1 Safety standard X1/Y1 Class certified product WEB
	DE2 Safety standard X1/Y2 Class certified product WEB
	Screw termination mounting
	DHS Ultra-high-voltage WEB
	DHK Ultra-high-voltage High voltage AC rated WEB

Catalog Information

Catalog relates to a multilayer ceramic capacitor is below.

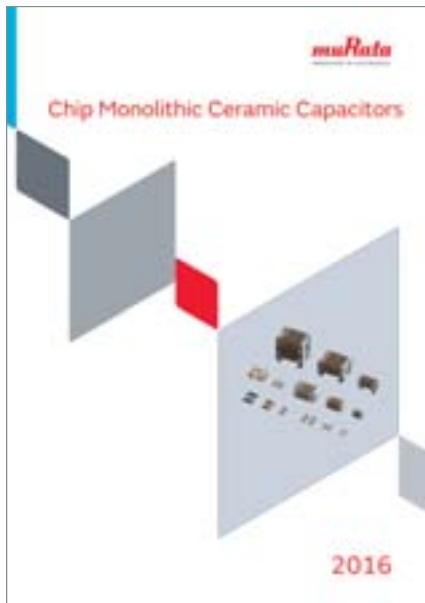

Chip Monolithic Ceramic Capacitors
Cat No. C02E-20

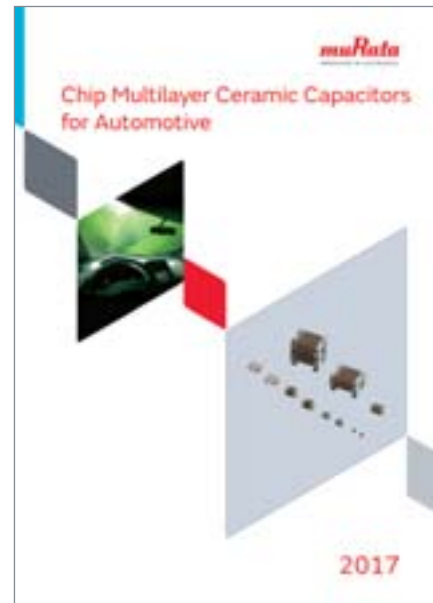

Chip Multilayer Ceramic Capacitors for Automotive
Cat No. C03E-9



**Safety Certified Ceramic Capacitors/
High Voltage Ceramic Capacitors**
Cat No. C85E-5



**Radial Lead Type
Monolithic Ceramic Capacitors**
Cat No. C49E-23

● Part Numbering

Chip Multilayer Ceramic Capacitors for Automotive



(Part Number)



① Product ID

② Series

Product ID	Code	Series
GC	3	High effective capacitance & High allowable ripple current
	D	Specially designed product to reduce shorts
	E	Specially designed product to reduce shorts & resin electrode product
	G	Limited to conductive glue mounting
	J	Soft termination type
	M	For automotive
GR	T	Meet AEC-Q200 for infotainment
KC	3	Metal terminal type/High effective capacitance & High allowable ripple current
	A	Metal terminal type/ Safety standard certified product
	M	Metal terminal type

③ Chip Dimension (L x W)

Code	Dimension (L x W)	EIA
03	0.6 x 0.3mm	0201
15	1.0 x 0.5mm	0402
18	1.6 x 0.8mm	0603
21	2.0 x 1.25mm	0805
31	3.2 x 1.6mm	1206
32	3.2 x 2.5mm	1210
43	4.5 x 3.2mm	1812
55	5.7 x 5.0mm	2220

⑤ Temperature Characteristics

Temperature Characteristic Codes			Temperature Characteristics			Operating Temperature Range	Capacitance Change Each Temperature (%)					
Code	Public STD Code	Reference Temperature	Temperature Range	Capacitance Change or Temperature Coefficient	-55°C		*4		-10°C			
					Max.		Min.	Max.	Min.	Max.	Min.	
5C	C0G	EIA	25°C	25 to 125°C	0±30ppm/°C	-55 to 125°C	0.58	-0.24	0.4	-0.17	0.25	-0.11
5G	X8G	*2	25°C	25 to 150°C	0±30ppm/°C	-55 to 150°C	0.58	-0.24	0.4	-0.17	0.25	-0.11
7U	U2J	EIA	25°C	25 to 125°C *3	-750±120ppm/°C	-55 to 125°C	8.78	5.04	6.04	3.47	3.84	2.21
9E	ZLM	*2	20°C	-55 to -40°C	-4700+1000/-2500ppm/°C	-55 to 125°C	-	-	-	-	-	-
				-40 to 20°C	-5350±750ppm/°C		-	-	-	-	-	
				20 to 85°C	-4700±500ppm/°C		-	-	-	-	-	
				85 to 125°C	-4700+2000/-1000ppm/°C		-	-	-	-	-	
C7	X7S	EIA	25°C	-55 to 125°C	±22%	-55 to 125°C	-	-	-	-	-	-
C8	X6S	EIA	25°C	-55 to 105°C	±22%	-55 to 105°C	-	-	-	-	-	-
D7	X7T	EIA	25°C	-55 to 125°C	+22%, -33%	-55 to 125°C	-	-	-	-	-	-
L8	X8L	*2	25°C	-55 to 150°C	+15%, -40%	-55 to 150°C	-	-	-	-	-	-
M8	X8M	*2	25°C	-55 to 150°C	+15%, -50%	-55 to 150°C	-	-	-	-	-	-
R6	X5R	EIA	25°C	-55 to 85°C	±15%	-55 to 85°C	-	-	-	-	-	-
R7	X7R	EIA	25°C	-55 to 125°C	±15%	-55 to 125°C	-	-	-	-	-	-
R9	X8R	EIA	25°C	-55 to 150°C	±15%	-55 to 150°C	-	-	-	-	-	-

*1 Capacitance change is specified with 50% rated voltage applied.

*2 Murata Temperature Characteristic Code.

*3 Rated Voltage 100Vdc max: 25 to 85°C

*4 -25°C (Reference Temperature 20°C) / -30°C (Reference Temperature 25°C)

④ Height Dimension (T) (Except KC□)

Code	Dimension (T)
3	0.3mm
5	0.5mm
6	0.6mm
8	0.8mm
9	0.85mm
A	1.0mm
B	1.25mm
C	1.6mm
D	2.0mm
E	2.5mm
M	1.15mm
Q	1.5mm
X	Depends on individual standards.

④ Height Dimension (T) (KC□ Only)

Code	Dimension (T)
L	2.8mm
Q	3.7mm
T	4.8mm
W	6.4mm

Continued on the following page. ↗

(Part Number)

GC	M	18	8	R7	1H	102	K	A37	D
1	2	3	4	5	6	7	8	9	10

Continued from the preceding page. ↘

⑥ Rated Voltage

Code		Rated Voltage
Standard Product	Voltage Derated Product	
0E	-	DC2.5V
0G	-	DC4V
0J	EC	DC6.3V
1A	ED	DC10V
1C	EE	DC16V
1E	EF	DC25V
YA	EG	DC35V
1H	EH	DC50V
1J	-	DC63V
1K	-	DC80V
2A	EL	DC100V
2E	-	DC250V
2W	LP	DC450V
2J	LQ	DC630V
3A	-	DC1kV
MF	-	X1/Y2: AC250V (Safety Standard Certified Type MF)

⑦ Capacitance

Expressed by three-digit alphanumerics. The unit is pico-farad (pF). The first and second figures are significant digits, and the third figure expresses the number of zeros that follow the two numbers.

If there is a decimal point, it is expressed by the capital letter "R."
 In this case, all figures are significant digits.

If any letter, other than "R" is included, this indicates the specific part number is a non-standard part.

Ex.)

Code	Capacitance
R50	0.50pF
1R0	1.0pF
100	10pF
103	10000pF

⑧ Capacitance Tolerance

Code	Capacitance Tolerance
C	±0.25pF
D	±0.5pF (Less than 10pF)
	±0.5% (10pF and over)
J	±5%
K	±10%
M	±20%

⑨ Individual Specification Code

Expressed by three figures.

⑩ Package

Code	Package
L	ø180mm Embossed Taping
D/W	ø180mm Paper Taping
K	ø330mm Embossed Taping
J	ø330mm Paper Taping

Please contact us if you find any part number not provided in this table.

3 Terminal Low ESL Multilayer Ceramic Capacitors



(Part Number)

NF	M	3D	CC	102	R	1H	3	L
1	2	3	4	5	6	7	8	9

1 Product ID 2 Series

Product ID	Series
NFM	3 Terminal Low ESL Type

3 Dimensions (LxW)

Code	Dimensions (LxW)	EIA
21	2.0x1.25mm	0805
31	3.2x1.6mm	1206

4 Features

Code	Features	
HC	Powertrain/Safety for Automotive	For Signal Lines / For Large Current
HK		For Very Large Current

5 Capacitance

Expressed by three figures. The unit is in pico-farad (pF). The first and second figures are significant digits, and the third figure expresses the number of zeros that follow the two figures.

6 Characteristics

Code	Capacitance Temperature Characteristics
R	±15%, +15/-18%

7 Rated Voltage

Code	Rated Voltage
1A	10V
1C	16V
1H	50V
2A	100V

8 Electrode

Code	Electrode
3	Sn Plating

9 Packaging

Code	Packaging
L	Embossed Taping (ø180mm Reel)
D	Paper Taping (ø180mm Reel)

Please contact us if you find any part number not provided in this table.

Capacitance Table

How to read the Capacitance Table

L×W (mm)	1.0×0.5			1.6×	
T max. (mm)	0.55			0.9	
Rated Voltage (Vdc)	100	50	25	100	50
Cap. / TC Code	COG	COG	COG	COG	COG
1.0pF	p24	p24		p24	p24
2.0pF	p24	p24		p24	p24
3.0pF	p24	p24		p24	p24
4.0pF	p24	p24		p24	p24
5.0pF	p24	p24		p24	p24

The values can be narrowed down in the order of size, rated voltage, and temperature characteristics.

Refers to the page of the part number list.
 Check the part number list for the applicable product number.

Temperature Characteristics Table

The Table is colored by temperature characteristic codes. Refer to the following Table for the meaning of each code.

Temperature Characteristic Codes		Temperature Characteristics			Operating Temperature Range	Capacitance Change Each Temperature (%)					
Public STD Code	Reference Temperature	Temperature Range	Capacitance Change or Temperature Coefficient	-55°C		*3		-10°C			
				Max.		Min.	Max.	Min.	Max.	Min.	
COG	EIA	25°C	25 to 125°C	0±30ppm/°C	-55 to 125°C	0.58	-0.24	0.4	-0.17	0.25	-0.11
X8G	*1	25°C	25 to 150°C	0±30ppm/°C	-55 to 150°C	0.58	-0.24	0.4	-0.17	0.25	-0.11
U2J	EIA	25°C	25 to 125°C *2	-750±120ppm/°C	-55 to 125°C	8.78	5.04	6.04	3.47	3.84	2.21
ZLM	*1	20°C	-55 to -40°C	-4700+1000/-2500ppm/°C	-55 to 125°C	-	-	-	-	-	-
			-40 to 20°C	-5350±750ppm/°C		-	-	-	-	-	-
			20 to 85°C	-4700±500ppm/°C		-	-	-	-	-	-
			85 to 125°C	-4700+2000/-1000ppm/°C		-	-	-	-	-	-
X7S	EIA	25°C	-55 to 125°C	±22%	-55 to 125°C	-	-	-	-	-	-
X6S	EIA	25°C	-55 to 105°C	±22%	-55 to 105°C	-	-	-	-	-	-
X7T	EIA	25°C	-55 to 125°C	+22%, -33%	-55 to 125°C	-	-	-	-	-	-
X8L	*1	25°C	-55 to 150°C	+15%, -40%	-55 to 150°C	-	-	-	-	-	-
X8M	*1	25°C	-55 to 150°C	+15%, -50%	-55 to 150°C	-	-	-	-	-	-
X5R	EIA	25°C	-55 to 85°C	±15%	-55 to 85°C	-	-	-	-	-	-
X7R	EIA	25°C	-55 to 125°C	±15%	-55 to 125°C	-	-	-	-	-	-
X8R	EIA	25°C	-55 to 150°C	±15%	-55 to 150°C	-	-	-	-	-	-

*1 Murata Temperature Characteristic Code.

*2 Rated Voltage 100Vdc max: 25 to 85°C

*3 -25°C (Reference Temperature 20°C) / -30°C (Reference Temperature 25°C)

Capacitance Table

p00 Each number in the Part Number List refers to the page number printed at the bottom of the page.

GRT Series Temperature Compensating Type

p00 ← Part Number List EIA: COG

L×W (mm)	1.0×0.5			1.6×0.8			2.0×1.25	3.2×1.6		
T max. (mm)	0.55			0.9			1.35	1.8		
Rated Voltage (Vdc)	100	50	25	100	50	25	50	50	25	16
Cap. / TC Code	COG	COG	COG	COG	COG	COG	COG	COG	COG	COG
1.0pF	p24	p24		p24	p25					
2.0pF	p24	p24		p24	p25					
3.0pF	p24	p24		p24	p25					
4.0pF	p24	p24		p24	p25					
5.0pF	p24	p24		p24	p25					
6.0pF	p24	p24		p24	p25					
7.0pF	p24	p24		p24	p25					
8.0pF	p24	p24		p24	p25					
9.0pF	p24	p24		p24	p25					
10pF	p24	p24	p24	p24	p25					
12pF	p24	p24	p24	p24	p25					
15pF	p24	p24	p24	p24	p25					
18pF	p24	p24	p24	p24	p25					
22pF	p24	p24	p24	p24	p25					
27pF	p24	p24	p24	p24	p25					
33pF	p24	p24	p24	p24	p25					
39pF	p24	p24	p24	p24	p25					
47pF	p24	p24	p24	p24	p25					
56pF	p24	p24	p24	p24	p25					
68pF	p24	p24	p24	p24	p25					
82pF	p24	p24	p24	p25	p25					
100pF	p24	p24	p24	p25	p25					
120pF		p24	p24	p25	p25					
150pF		p24	p24	p25	p25					
180pF		p24	p24	p25	p25					
220pF		p24	p24	p25	p25					
270pF		p24	p24	p25	p25					
330pF		p24	p24	p25	p25					
390pF		p24	p24	p25	p25					
470pF		p24	p24	p25	p25					
560pF		p24	p24	p25	p25	p25				
680pF		p24	p24	p25	p25	p25				
820pF		p24	p24	p25	p25	p25				
1000pF		p24	p24	p25	p25	p25				
1200pF				p25	p25	p25				
1500pF				p25	p25	p25				
1800pF					p25					
2200pF					p25					
2700pF					p25					
3300pF					p25					
3900pF					p25					
4700pF					p25	p25				
5600pF					p25	p25				
6800pF					p25	p25				
8200pF					p25	p25				
10000pF					p25	p25				
18000pF							p25			
22000pF							p25			
56000pF								p25		
68000pF								p25		
82000pF								p25		
0.10μF								p25	p25	
0.12μF									p25	p25

Capacitance Table

p00 Each number in the Part Number List refers to the page number printed at the bottom of the page.

GRT Series High Dielectric Constant Type

p00 ← Part Number List EIA: X6S X7S X5R X7R

L×W (mm)	0.6×0.3												1.0×0.5											
	0.33						0.35						0.55											
T max. (mm)	0.33						0.35						0.55											
Rated Voltage (Vdc)	35	25		16		10		6.3		4		6.3	4	50	35	25		16		10				
Cap. / TC Code	X5R	X7R	X6S	X5R	X6S	X5R	X7R	X6S	X5R	X7R	X6S	X5R	X6S	X5R	X5R	X7R	X6S	X5R	X7R	X6S	X5R	X7R	X6S	
100pF				p26																				
220pF				p26												p26								
470pF		p26	p26	p26												p26								
1000pF		p26	p26	p26												p26								
2200pF								p26	p26	p26						p26								
4700pF				p26				p26	p26	p26						p26								
10000pF				p26		p26	p26	p26	p26	p26						p26		p26			p26			
22000pF						p26		p26		p26	p26					p26		p26			p26			
47000pF						p26		p26		p26	p26					p26		p26			p26			
68000pF										p26	p26	p26												
0.10μF	p26		p26	p26	p26	p26		p26	p26	p26	p26					p26		p26			p26			
0.22μF								p26		p26	p26	p26				p26	p26		p26	p26	p26		p26	p26
0.47μF											p26						p26		p26		p26	p26	p26	
1.0μF													p26	p26				p26			p26		p26	
2.2μF																								
4.7μF																								
10μF																								
22μF																								
33μF																								
47μF																								
100μF																								

Continued to the following table. ↗

L×W (mm)	1.0×0.5															1.6×0.8									
	0.55					0.6					0.65					0.7					0.9				
Rated Voltage (Vdc)	10	6.3		4	35	25	16	10	6.3	4	10	6.3	25	16	10	2.5	50	35	25		16				
Cap. / TC Code	X5R	X7R	X6S	X5R	X7R	X5R	X6S	X6S	X7S	X5R	X5R	X5R	X6S	X5R	X6S	X5R	X6S	X5R	X6S	X7R	X6S	X5R	X7R		
100pF																									
220pF																									
470pF																									
1000pF																									
2200pF																									
4700pF																									
10000pF																									
22000pF		p26																							
47000pF																									
68000pF																									
0.10μF																									
0.22μF	p26		p26	p26																					
0.47μF	p26		p26	p26																					
1.0μF	p26	p26	p26	p26	p26	p26	p26	p26												p27	p27	p27	p27	p27	p27
2.2μF	p26		p26	p26													p27	p27	p27	p27			p27		
4.7μF																									
10μF																									
22μF																									
33μF																									
47μF																									
100μF																									

Continued on the following page. ↗

Capacitance Table

p00 Each number in the Part Number List refers to the page number printed at the bottom of the page.

(→ GRT Series High Dielectric Constant Type)

p00 ← Part Number List EIA: X6S X7S X5R X7R

L×W (mm)	1.6×0.8																2.0×1.25																											
	0.9								0.95								1.0								1.35																			
T max. (mm)	16				10				6.3				4				25				16				10				6.3				4				50				25			
Rated Voltage (Vdc)	X6S		X5R		X6S		X5R		X7R		X6S		X5R		X6S		X5R		X5R		X6S		X5R		X6S		X5R		X6S		X5R		X6S		X5R		X7R		X6S		X5R			
Cap. / TC Code	X6S	X5R	X6S	X5R	X7R	X6S	X5R	X6S	X5R	X5R	X6S	X5R	X5R	X6S	X5R	X5R	X6S	X5R	X6S	X5R	X6S	X5R	X6S	X5R	X6S	X5R	X6S	X5R	X6S	X5R	X6S	X5R	X6S	X5R	X7R	X6S	X5R							
100pF																																												
220pF																																												
470pF																																												
1000pF																																												
2200pF																																												
4700pF																																												
10000pF																																												
22000pF																																												
47000pF																																												
68000pF																																												
0.10μF																																												
0.22μF																																												
0.47μF																																												
1.0μF	p27	p27	p27	p27																																		p27						
2.2μF	p27																																						p27	p27				
4.7μF																																							p27	p27				
10μF																																												
22μF																																												
33μF																																												
47μF																																												
100μF																																												

Continued to the following table. ↗

L×W (mm)	2.0×1.25																3.2×1.6																															
	1.35								1.4								1.45								1.8																							
T max. (mm)	16				10				6.3				50				35				25				16				10				6.3				4				50				35			
Rated Voltage (Vdc)	X7R		X6S		X5R		X6S		X5R		X7R		X6S		X5R		X7R		X6S		X5R		X7R		X6S		X5R		X6S		X5R		X7R		X6S		X5R											
Cap. / TC Code	X7R	X6S	X5R	X6S	X5R	X7R	X6S	X5R	X6S	X5R	X7R	X6S	X5R	X6S	X5R	X7R	X6S	X5R	X6S	X5R	X7R	X6S	X5R	X6S	X5R	X7R	X6S	X5R	X6S	X5R	X7R	X6S	X5R	X6S	X5R	X7R	X6S	X5R										
100pF																																																
220pF																																																
470pF																																																
1000pF																																																
2200pF																																																
4700pF																																																
10000pF																																																
22000pF																																																
47000pF																																																
68000pF																																																
0.10μF																																																
0.22μF																																																
0.47μF																																																
1.0μF																																																
2.2μF	p27	p27	p27																																				p27	p27								
4.7μF		p27	p27																																													
10μF		p27	p27	p27	p27	p27																																		p27	p27							
22μF																																																
33μF																																																
47μF																																																
100μF																																																

Continued on the following page. ↗

Capacitance Table

p00 Each number in the Part Number List refers to the page number printed at the bottom of the page.

(→ GRT Series High Dielectric Constant Type)

p00 ← Part Number List EIA: **X6S** **X7S** **X5R** **X7R**

L×W (mm)	3.2×1.6											3.2×2.5										
	1.8											2.2			2.7							
T max. (mm)	1.8											2.2			2.7							
Rated Voltage (Vdc)	25			16		10		6.3		4		25		6.3	50		16	10		6.3		
Cap. / TC Code	X7R	X6S	X5R	X6S	X5R	X6S	X5R	X7R	X6S	X5R	X6S	X6S	X5R	X5R	X7R	X6S	X6S	X6S	X7R	X6S	X5R	
100pF																						
220pF																						
470pF																						
1000pF																						
2200pF																						
4700pF																						
10000pF																						
22000pF																						
47000pF																						
68000pF																						
0.10μF																						
0.22μF																						
0.47μF																						
1.0μF																						
2.2μF																						
4.7μF																						
10μF	p27	p27	p27									p28	p28									
22μF			p28	p28	p28	p28	p28	p28	p28	p28	p28											
33μF														p28								
47μF							p28		p28	p28	p28							p28	p28	p28	p28	
100μF																						p28

Capacitance Table

p00 Each number in the Part Number List refers to the page number printed at the bottom of the page.

GCM Series Temperature Compensating Type

p00 ← Part Number List EIA: C0G U2J Murata Temperature Characteristic: X8G ZLM

L×W (mm)	1.0×0.5		1.6×0.8		2.0×1.25										3.2×1.6											
	T max. (mm)		0.9		0.7		0.95				1.0		1.4		1.45		0.95		1.0							
Rated Voltage (Vdc)	50		100		50		100	50	100	80	63	50	630	250	80	63	50	630	250	100	80	1000	630			
Cap. / TC Code	C0G	X8G	C0G	U2J	C0G	U2J	C0G	C0G	ZLM	C0G	C0G	C0G	C0G	C0G	U2J	C0G	C0G	C0G	C0G	U2J	C0G	C0G	C0G	U2J	C0G	
1.0pF	p30	p30	p30		p31																					
2.0pF	p30	p30	p30		p31																					
3.0pF	p30	p30	p30		p31																					
4.0pF	p30	p30	p30		p31																					
5.0pF	p30	p30	p30		p31																					
6.0pF	p30		p30		p31																					
7.0pF	p30		p30		p31																					
8.0pF	p30		p30		p31																					
9.0pF	p30		p30		p31																					
10pF	p30		p30		p31								p32	p32									p32	p33	p33	
12pF	p30	p30	p30		p31								p32	p32									p32	p33	p33	
15pF	p30	p30	p30		p31								p32	p32									p32	p33	p33	
18pF	p30	p30	p30		p31								p32	p32									p32	p33	p33	
22pF	p30	p30	p30		p31								p32	p32									p32	p33	p33	
27pF	p30	p30	p30		p31								p32	p32									p32	p33	p33	
33pF	p30	p30	p30		p31								p32	p32									p32	p33	p33	
39pF	p30	p30	p30		p31								p32	p32									p33	p33	p33	
47pF	p30	p30	p30		p31								p32	p32									p33	p33	p33	
56pF	p30	p30	p30		p31								p32	p32									p33	p33	p33	
68pF	p30	p30	p30		p31								p32	p32									p33	p33	p33	
82pF	p30	p30	p30		p31								p32	p32									p33	p33	p33	
100pF	p30	p30	p30		p31		p31						p32	p32	p32								p33	p33	p33	
120pF	p30	p30	p30		p31		p31						p32	p32	p32								p33	p33	p33	
150pF	p30	p30	p30		p31		p31						p32	p32	p32								p33	p33	p33	
180pF	p30	p30	p30		p31		p31						p32	p32	p32								p33	p33	p33	
220pF	p30	p30	p30		p31		p31						p32	p32	p32								p33	p33	p33	
270pF	p30	p30	p30		p31		p31						p32	p32	p32								p33	p33	p33	
330pF	p30	p30	p30		p31		p31						p32	p32	p32								p33	p33	p33	
390pF	p30	p30	p30		p31		p31						p32	p32	p32								p33		p33	
470pF	p30	p30	p30		p31		p31						p32	p32	p32								p33		p33	
560pF	p30	p30	p30		p31		p31						p32	p32	p32										p33	
680pF	p30	p30	p30		p31		p31							p32	p32			p32							p33	
820pF	p30	p30	p30		p31		p31							p32	p32			p32							p33	
1000pF	p30	p30	p30	p30	p31	p31	p31		p31					p32	p32			p32							p33	
1100pF										p31																
1200pF			p30	p30	p31	p31	p31							p32	p32			p32							p33	
1300pF																										
1500pF			p30	p31	p31	p31	p31							p32	p32										p33	
1800pF				p31	p31	p31	p31							p32	p32										p33	
2200pF				p31	p31	p31	p31							p32	p32											
2700pF				p31	p31	p31	p31							p32												
3300pF				p31	p31	p31	p31												p32	p32						
3900pF				p31	p31	p31													p32	p32	p32					
4700pF				p31		p31		p31											p32	p32	p32					
5600pF				p31		p31							p31							p32	p32					
6800pF				p31		p31							p31								p32	p32				
8200pF				p31		p31							p31									p32	p32			
10000pF				p31		p31							p31									p32	p32			
12000pF													p31													
15000pF													p31	p31	p31											
18000pF																										
20000pF																										
22000pF																										
27000pF																										
33000pF																										
39000pF																										
47000pF																										

Continued on the following page. ↗

Capacitance Table

p00 Each number in the Part Number List refers to the page number printed at the bottom of the page.

(→ GCM Series Temperature Compensating Type)

p00 ← Part Number List EIA: C0G U2J Murata Temperature Characteristic: X8G ZLM

L×W (mm)	3.2×1.6												3.2×2.5						4.5×3.2			
	1.0		1.25				1.8						1.0	1.25	1.5	2.0		1.5	2.0			
T max. (mm)	630	250	1000		630	250	1000		630	250	630	1000	630	1000	630	1000	630	1000	630	1000	630	
Rated Voltage (Vdc)	630	250	1000		630	250	1000		630	250	630	1000	630	1000	630	1000	630	1000	630	1000	630	
Cap. / TC Code	U2J	C0G	U2J	C0G	U2J	C0G	U2J	C0G	U2J	C0G	U2J	C0G	U2J	C0G	U2J	C0G	U2J	C0G	U2J	C0G	U2J	
1.0pF																						
2.0pF																						
3.0pF																						
4.0pF																						
5.0pF																						
6.0pF																						
7.0pF																						
8.0pF																						
9.0pF																						
10pF	p33	p33																				
12pF	p33	p33																				
15pF	p33	p33																				
18pF	p33	p33																				
22pF	p33	p33																				
27pF	p33	p33																				
33pF	p33	p33																				
39pF	p33	p33																				
47pF	p33	p33																				
56pF	p33	p33																				
68pF	p33	p33																				
82pF	p33	p33																				
100pF	p33	p33																				
120pF	p33	p33																				
150pF	p33	p33																				
180pF	p33	p33																				
220pF	p33	p33																				
270pF	p33	p33																				
330pF	p33	p34																				
390pF	p33	p34			p34																	
470pF	p33	p34			p34																	
560pF	p33	p34		p34	p34																	
680pF	p33	p34		p34	p34																	
820pF	p33	p34						p34	p34													
1000pF	p33	p34						p34	p34													
1100pF																						
1200pF	p33	p34										p34	p34									
1300pF																						
1500pF	p33	p34										p34		p34								
1800pF	p33	p34										p34				p34						
2200pF	p33	p34				p34						p34				p34						
2700pF		p34	p34			p34	p34												p34			
3300pF		p34	p34				p34				p34								p34			
3900pF		p34	p34																		p34	
4700pF		p34	p34																		p34	
5600pF		p34	p34																			
6800pF		p34																				
8200pF									p34	p34										p34		
10000pF									p34	p34										p34		
12000pF									p34													
15000pF																						p34
18000pF																						p34
20000pF																						
22000pF																						p34
27000pF																						
33000pF																						
39000pF																						
47000pF																						

Continued on the following page. ↗

Capacitance Table

p00 Each number in the Part Number List refers to the page number printed at the bottom of the page.

(→ GCM Series Temperature Compensating Type)

p00 ← Part Number List EIA: C0G U2J Murata Temperature Characteristic: X8G ZLM

L×W (mm)	5.7×5.0			
	1.5		2.0	
T max. (mm)	1.5		2.0	
Rated Voltage (Vdc)	1000	630	1000	630
Cap. / TC Code	U2J	U2J	U2J	U2J
1.0pF				
2.0pF				
3.0pF				
4.0pF				
5.0pF				
6.0pF				
7.0pF				
8.0pF				
9.0pF				
10pF				
12pF				
15pF				
18pF				
22pF				
27pF				
33pF				
39pF				
47pF				
56pF				
68pF				
82pF				
100pF				
120pF				
150pF				
180pF				
220pF				
270pF				
330pF				
390pF				
470pF				
560pF				
680pF				
820pF				
1000pF				
1100pF				
1200pF				
1300pF				
1500pF				
1800pF				
2200pF				
2700pF				
3300pF				
3900pF				
4700pF				
5600pF	p34			
6800pF	p34			
8200pF		p34		
10000pF		p34		
12000pF				
15000pF				
18000pF				
20000pF				
22000pF				
27000pF	p34			
33000pF				p34
39000pF				p34
47000pF				p34

Capacitance Table

p00 Each number in the Part Number List refers to the page number printed at the bottom of the page.

GCM Series High Dielectric Constant Type

p00 ← Part Number List EIA: X7S X7R Murata Temperature Characteristic: X8L

L×W (mm)	0.6×0.3			1.0×0.5						1.6×0.8					2.0×1.25										
T max. (mm)	0.33			0.55			0.6	0.7	0.9					0.7	0.95			1.4							
Rated Voltage (Vdc)	25	16	10	100	50	25	16	10	10	100	50	25	16	6.3	100	100	50	25	16	100	50	35			
Cap. / TC Code	X7R	X7R	X7R	X7R	X8L	X7R	X8L	X7R	X7S	X7R	X7R	X7R	X7R	X7R	X7R	X7R	X7R	X7R	X7R	X7R	X7R	X7R	X8L	X7R	X7S
100pF	p35																								
150pF	p35																								
220pF	p35			p35		p35																			
330pF	p35	p35		p35		p35																			
470pF	p35			p35		p35																			
680pF	p35	p35		p35		p35																			
1000pF	p35			p35		p35							p35												
1500pF	p35			p35		p35							p35												
2200pF	p35	p35		p35		p35							p35												
3300pF	p35	p35		p35		p35							p35												
4700pF			p35	p35		p35							p35												
6800pF			p35			p35							p35				p35								
10000pF			p35			p35		p35					p35				p35								
15000pF						p35		p35					p35				p35								
22000pF						p35		p35					p35				p35								
33000pF					p35	p35		p35	p35							p35									
47000pF					p35	p35		p35	p35													p35			
68000pF					p35	p35		p35	p35													p35			
0.10μF					p35	p35	p35		p35													p35			
0.15μF									p35														p35		
0.22μF									p35					p35	p35								p36	p36	
0.33μF																p35									
0.47μF									p35						p35	p35							p36		
0.68μF										p35						p35	p35						p36		
1.0μF										p35						p35	p35						p36		
1.5μF																							p36		
2.2μF																								p36	
4.7μF																p35									
10μF																									
22μF																									
47μF																									

Continued on the following page. ↗

Capacitance Table

p00 Each number in the Part Number List refers to the page number printed at the bottom of the page.

(→ GCM Series High Dielectric Constant Type)

p00 ← Part Number List EIA: X7S X7R Murata Temperature Characteristic: X8L

L×W (mm)	2.0×1.25										3.2×1.6								3.2×2.5						
	1.4					1.45					1.25		1.8						1.9	2.2					
T max. (mm)											100	50							25	100					
Rated Voltage (Vdc)	25	16	10	6.3	100	35	25	16	100	50	100	50	25	16	10	6.3	25	100							
Cap. / TC Code	X8L	X7R	X7R	X7S	X7R	X7S	X8L	X7S	X8L	X7S	X7S	X7R	X7R	X8L	X7R	X7S	X7R	X7S	X7R	X7R	X7R	X7S	X8L	X7S	
100pF																									
150pF																									
220pF																									
330pF																									
470pF																									
680pF																									
1000pF																									
1500pF																									
2200pF																									
3300pF																									
4700pF																									
6800pF																									
10000pF																									
15000pF																									
22000pF																									
33000pF																									
47000pF																									
68000pF																									
0.10μF																									
0.15μF	p36	p36																							
0.22μF		p36									p36														
0.33μF		p36										p36													
0.47μF													p36												
0.68μF		p36												p36											
1.0μF		p36							p36							p36									
1.5μF		p36																							
2.2μF		p36	p36	p36																					
4.7μF			p36		p36				p36	p36	p36	p36												p36	p36
10μF				p36		p36						p36													
22μF																									
47μF																									

Continued on the following page. ↗

Capacitance Table

p00 Each number in the Part Number List refers to the page number printed at the bottom of the page.

(→ GCM Series High Dielectric Constant Type)

p00 ← Part Number List EIA: X7S X7R Murata Temperature Characteristic: X8L

L×W (mm)	3.2×2.5									
	2.2		2.7						2.85	
T max. (mm)	2.2		2.7						2.85	
Rated Voltage (Vdc)	16	50			35	25	16	10	6.3	25
Cap. / TC Code	X7R	X8L	X7R	X7S	X7S	X7R	X7R	X7R	X8L	X7S
100pF										
150pF										
220pF										
330pF										
470pF										
680pF										
1000pF										
1500pF										
2200pF										
3300pF										
4700pF										
6800pF										
10000pF										
15000pF										
22000pF										
33000pF										
47000pF										
68000pF										
0.10μF										
0.15μF										
0.22μF										
0.33μF										
0.47μF										
0.68μF										
1.0μF										
1.5μF										
2.2μF										
4.7μF				p36						
10μF	p36	p36		p36	p36	p36				
22μF							p36	p36	p36	p36
47μF								p36		

GC3 Series High Dielectric Constant Type

p00 ← Part Number List EIA: X7T

L×W (mm)	2.0×1.25		3.2×1.6				3.2×2.5				4.5×3.2				5.7×5.0						
	1.0	1.45	1.0	1.25	1.8	1.5	2.0	1.5	2.0	1.5	2.0	2.0	2.7								
Rated Voltage (Vdc)	250	250	450	250	630	450	250	630	450	250	630	250	630	450	250	630	450	250	630	250	
Cap. / TC Code	X7T	X7T	X7T	X7T	X7T	X7T	X7T	X7T	X7T	X7T	X7T	X7T	X7T	X7T	X7T	X7T	X7T	X7T	X7T	X7T	
10000pF	p38		p38		p38																
15000pF	p38		p38				p38														
22000pF		p38			p38			p38													
33000pF				p38	p38					p38											
47000pF						p38		p38				p38									
68000pF									p38				p38								
0.10μF										p38				p38							
0.15μF													p38								
0.22μF														p38							
0.33μF															p38						
0.47μF																p38					
0.68μF																	p38				
1.0μF																		p38			

Capacitance Table

p00 Each number in the Part Number List refers to the page number printed at the bottom of the page.

(→ GCJ Series High Dielectric Constant Type)

p00 ← Part Number List EIA: X7S X7R X8R Murata Temperature Characteristic: X8L X8M

L×W (mm)	3.2×1.6						3.2×2.5										4.5×3.2					5.7×5.0													
	2.0		1.5		2.0		2.3		2.8			2.85		1.5		2.0			2.0																
Rated Voltage (Vdc)	25		630		250		1000		630		250		100		50			25		16		6.3		25		630		250		1000		630		250	
Cap. / TC Code	X8L	X7S	X7R	X7R	X7R	X7R	X7R	X7R	X8L	X7R	X7S	X7R	X7S	X8L	X8R	X7R	X7R	X8L	X7S	X7R	X7R	X7R	X7R	X7R	X7R	X7R	X7R	X7R	X7R	X7R	X7R	X7R			
220pF																																			
270pF																																			
330pF																																			
390pF																																			
470pF																																			
560pF																																			
680pF																																			
820pF																																			
1000pF																																			
1200pF																																			
1500pF																																			
1800pF																																			
2200pF																																			
2700pF																																			
3300pF																																			
3900pF																																			
4700pF																																			
5600pF																																			
6800pF																																			
8200pF																																			
10000pF																																			
12000pF																																			
15000pF																																			
18000pF																																			
22000pF																																			
27000pF																																			
33000pF																																			
39000pF																																			
47000pF																																			
56000pF																																			
68000pF																																			
82000pF																																			
0.10μF																																			
0.12μF																																			
0.15μF																																			
0.18μF																																			
0.22μF																																			
0.27μF																																			
0.33μF																																			
0.39μF																																			
0.47μF																																			
0.56μF																																			
0.68μF																																			
0.82μF																																			
1.0μF																																			
1.5μF																																			
2.2μF																																			
3.3μF																																			
4.7μF																																			
6.8μF																																			
10μF																																			
22μF																																			
47μF																																			

Capacitance Table

p00 Each number in the Part Number List refers to the page number printed at the bottom of the page.

GCD Series High Dielectric Constant Type

p00 ← Part Number List EIA: X7R

L×W (mm)	1.6×0.8			2.0×1.25			
	T max. (mm)			0.9	0.7	0.95	1.4
Rated Voltage (Vdc)	100	50	25	100	100	100	50
Cap. / TC Code	X7R	X7R	X7R	X7R	X7R	X7R	X7R
1000pF	p46	p46		p46			
1200pF	p46	p46		p46			
1500pF	p46	p46		p46			
1800pF	p46	p46		p46			
2200pF	p46	p46		p46			
2700pF	p46	p46		p46			
3300pF	p46	p46		p46			
3900pF	p46	p46		p46			
4700pF	p46	p46		p46			
5600pF	p46	p46		p46			
6800pF	p46	p46			p46		
8200pF	p46	p46				p46	
10000pF	p46	p46				p46	
12000pF	p46	p46				p46	
15000pF	p46	p46				p46	p46
18000pF	p46	p46				p46	p46
22000pF	p46	p46				p46	p46
27000pF			p46			p46	p46
33000pF			p46			p46	p46
39000pF			p46			p46	p46
47000pF			p46			p46	p46
56000pF						p46	p46
68000pF						p46	p46
82000pF						p46	p46
0.10μF						p46	p46

GCE Series High Dielectric Constant Type

p00 ← Part Number List EIA: X7R

L×W (mm)	1.6×0.8			2.0×1.25			
	T max. (mm)			0.9	0.7	0.95	1.45
Rated Voltage (Vdc)	100	50	25	100	100	100	50
Cap. / TC Code	X7R	X7R	X7R	X7R	X7R	X7R	X7R
220pF						p48	
270pF						p48	
330pF						p48	
390pF						p48	
470pF						p48	
560pF						p48	
680pF						p48	
820pF						p48	
1000pF	p48	p48			p48		
1200pF	p48	p48			p48		
1500pF	p48	p48			p48		
1800pF	p48	p48			p48		
2200pF	p48	p48			p48		
2700pF	p48	p48			p48		
3300pF	p48	p48			p48		
3900pF	p48	p48			p48		
4700pF	p48	p48			p48		
5600pF	p48	p48			p48		
6800pF	p48	p48				p48	
8200pF	p48	p48					p48
10000pF	p48	p48					p48
12000pF	p48	p48					p48
15000pF	p48	p48					p48 p48
18000pF	p48	p48					p48 p48
22000pF	p48	p48					p48 p48
27000pF			p48				p48 p48
33000pF			p48				p48 p48
39000pF			p48				p48 p48
47000pF			p48				p48 p48
56000pF							p48 p48
68000pF							p48 p48
82000pF							p48 p48
0.10μF							p48 p48

NFM Series

p00 ← Part Number List

L×W (mm)	2.0×1.25			3.2×1.6	
	T max. (mm)			0.95	1.5
Rated Voltage (Vdc)	50	16	10	100	50
Cap. / TC Code	-	-	-	-	-
220pF	p50				
470pF	p50				
1000pF	p50				
2200pF	p50				
10000pF				p50	p50
15000pF					p50
22000pF	p50				p50
0.10μF			p50		p50
0.22μF			p50		
0.47μF			p50		
1.0μF		p50			

Capacitance Table

p00 Each number in the Part Number List refers to the page number printed at the bottom of the page.

KCM Series High Dielectric Constant Type

p00 ← Part Number List EIA: X7S X7R

L×W (mm)	6.1×5.3																		
T max. (mm)	3.0				3.9					5.0				6.7					
Rated Voltage (Vdc)	100	63	50	35	25	100	63	50	35	25	100	50	35	25	100	63	50	35	25
Cap. / TC Code	X7R	X7R	X7R	X7R	X7R	X7R	X7R	X7R	X7R	X7S	X7R	X7R	X7R	X7R	X7R	X7R	X7R	X7R	X7S
4.7μF	p53	p53	p53																
6.8μF						p53													
10μF			p53	p53		p53	p53				p53								
15μF				p53	p53										p53				
17μF								p53	p53										
22μF									p53	p53			p53	p53		p53	p53		
33μF										p53				p53	p53			p53	
47μF											p53							p53	p53
68μF																			p53
100μF																			p53

KC3 Series High Dielectric Constant Type

p00 ← Part Number List EIA: X7T

L×W (mm)	6.1×5.3											
T max. (mm)	3.0			3.9			5.0			6.7		
Rated Voltage (Vdc)	630	450	250	630	450	250	630	450	250	630	450	250
Cap. / TC Code	X7T	X7T	X7T	X7T	X7T	X7T	X7T	X7T	X7T	X7T	X7T	X7T
0.10μF	p56											
0.15μF	p56											
0.22μF		p56		p56								
0.27μF				p56								
0.33μF	p56	p56									p56	
0.47μF	p56	p56	p56								p56	
0.56μF				p56	p56						p56	
0.68μF		p56	p56				p56	p56				
1.0μF					p56	p56	p56	p56				
1.2μF										p56	p56	
1.5μF								p56	p56			
2.2μF											p56	p56

GCG Series Temperature Compensating Type

p00 ← Part Number List Murata Temperature Characteristic: X8G

L×W (mm)	1.0×0.5	1.6×0.8	2.0×1.25	
T max. (mm)	0.55	0.9	0.7	0.95
Rated Voltage (Vdc)	50	50	50	50
Cap. / TC Code	X8G	X8G	X8G	X8G
10pF		p61		
12pF		p61		
15pF		p61		
18pF		p61		
22pF		p61		
27pF		p61		
33pF		p61		
39pF		p61		
47pF		p61		
56pF		p61		
68pF		p61		
82pF		p61		
100pF		p61		
120pF	p61	p61		
150pF	p61	p61		
180pF	p61	p61		
220pF	p61	p61		
270pF	p61	p61		
330pF	p61	p61		
390pF	p61	p61		
470pF	p61	p61		
560pF		p61		
680pF		p61		
820pF		p61		
1000pF		p61	p61	
1200pF		p61	p61	
1500pF		p61	p61	
1800pF		p61	p61	
2200pF		p61	p61	
2700pF			p61	
3300pF			p61	
3900pF			p61	
4700pF			p61	
5600pF				p61
6800pF				p61
8200pF				p61
10000pF				p61

KCA Series Temperature Compensating Type

p00 ← Part Number List EIA: U2J

L×W (mm)	6.1×5.3			
T max. (mm)	3.0	3.9	5.0	6.7
Rated Voltage (Vac (r.m.s.))	250	250	250	250
Cap. / TC Code	U2J	U2J	U2J	U2J
100pF	p59			
150pF	p59			
220pF	p59			
330pF	p59			
470pF	p59			
680pF	p59			
1000pF	p59			
1500pF	p59			
2200pF	p59			
3300pF	p59			
4700pF		p59		
6800pF			p59	
10000pF				p59

Capacitance Table

p00 Each number in the Part Number List refers to the page number printed at the bottom of the page.

GCG Series High Dielectric Constant Type

p00 ← Part Number List EIA: X7S X7R X8R Murata Temperature Characteristic: X8L

L×W (mm)	1.0×0.5					1.6×0.8							2.0×1.25													
	0.55					0.9							0.95		1.45											
T max. (mm)																										
Rated Voltage (Vdc)	50	25	16	100		50	25	16	10	6.3	50	100	50	35	25											
Cap. / TC Code	X7R	X8L	X7R	X8L	X7R	X8R	X8L	X8R	X7R	X8R	X7R	X8L	X8R	X7R	X7R	X8R	X7R	X8L	X8R	X7R	X8L	X7R	X8L	X8R	X7R	
220pF	p62					p62																				
270pF	p62					p62																				
330pF	p62					p62																				
390pF	p62					p62																				
470pF	p62					p62																				
560pF	p62					p62																				
680pF	p62					p62																				
820pF	p62					p62																				
1000pF	p62					p62	p62			p63																
1200pF	p62					p62	p62	p62		p63																
1500pF	p62					p62	p62	p62		p63																
1800pF	p62					p62	p62			p63																
2200pF	p62					p62	p62	p62		p63																
2700pF	p62					p62	p62	p62		p63																
3300pF	p62					p62	p62	p62		p63																
3900pF	p62					p62	p62	p62		p63																
4700pF	p62					p62	p62	p62		p63																
5600pF		p62	p62			p62	p62	p63		p63																
6800pF		p62	p62			p62	p62	p63		p63																
8200pF		p62	p62			p62	p62	p63		p63																
10000pF		p62	p62			p62	p62	p63	p63	p63							p63									
12000pF						p62	p62																			
15000pF				p62	p62	p62	p62	p63	p63	p63																
18000pF				p62	p62	p62	p62										p63									
22000pF				p62	p62	p62	p62	p63	p63	p63																
27000pF				p62	p62	p62			p63																	
33000pF				p62	p62	p62			p63	p63	p63															
39000pF				p62	p62	p62				p63																p63
47000pF				p62	p62	p62				p63	p63	p63														
56000pF					p62	p62				p63																
68000pF					p62	p62				p63	p63						p63									
82000pF					p62					p63																p63
0.10μF					p62	p62				p63	p63															p63
0.12μF										p63																
0.15μF										p62	p63	p63														p63
0.18μF										p63																p63
0.22μF										p62	p63	p63														p63
0.27μF																										p63
0.33μF																										p63
0.39μF																										p63
0.47μF																										p63
0.56μF																										p63
0.68μF																										p63
0.82μF																										p63
1.0μF																										p63
1.2μF																										p63
1.5μF																										p63
2.2μF																										p63
3.3μF																										p63
3.9μF																										p63
4.7μF																										p63
6.8μF																										p63
10μF																										p63
22μF																										p63
47μF																										p63

Continued on the following page. ↗

Capacitance Table

p00 Each number in the Part Number List refers to the page number printed at the bottom of the page.

(→ GCG Series High Dielectric Constant Type)

p00 ← Part Number List EIA: X7S X7R X8R Murata Temperature Characteristic: X8L

L×W (mm)	2.0×1.25					3.2×1.6						3.2×2.5											
T max. (mm)	1.45					1.35			1.9			2.3	2.8										
Rated Voltage (Vdc)	16	10	6.3	50	25	16	25	16	6.3	25	50	35	25	16	6.3								
Cap. / TC Code	X8L	X7R	X7R	X8L	X7R	X8R	X8R	X7R	X8L	X8R	X7R	X8L	X8R	X7R	X7R	X8L	X7S	X8L	X7S	X7R	X8R	X7R	
220pF																							
270pF																							
330pF																							
390pF																							
470pF																							
560pF																							
680pF																							
820pF																							
1000pF																							
1200pF																							
1500pF																							
1800pF																							
2200pF																							
2700pF																							
3300pF																							
3900pF																							
4700pF																							
5600pF																							
6800pF																							
8200pF																							
10000pF																							
12000pF																							
15000pF																							
18000pF																							
22000pF																							
27000pF																							
33000pF																							
39000pF																							
47000pF																							
56000pF																							
68000pF																							
82000pF																							
0.10μF																							
0.12μF																							
0.15μF																							
0.18μF																							
0.22μF																							
0.27μF																							
0.33μF																							
0.39μF																							
0.47μF																							
0.56μF																							
0.68μF																							
0.82μF																							
1.0μF																							
1.2μF																							
1.5μF																							
2.2μF																							
3.3μF																							
3.9μF																							
4.7μF																							
6.8μF																							
10μF																							
22μF																							
47μF																							

Search Capacitors

Specifications and Test Methods, Package, Chart of Characteristic Data, please refer to the search web page.
<http://www.murata.com/en-global/products/capacitor>

GRT Series Temperature Compensating

1.0x0.5mm

T max.	Rated Voltage	TC Code	Cap.	Tol.	Part Number
0.55mm	100Vdc	COG	1.0pF	±0.25pF	GRT1555A1R0CA02#
			2.0pF	±0.25pF	GRT1555A2R0CA02#
			3.0pF	±0.25pF	GRT1555A3R0CA02#
			4.0pF	±0.25pF	GRT1555A4R0CA02#
			5.0pF	±0.25pF	GRT1555C2A5R0CA02#

Links are provided to the product detail pages on the web, and are shown below in the product number table from the PDF version of the catalog which is available on the web.

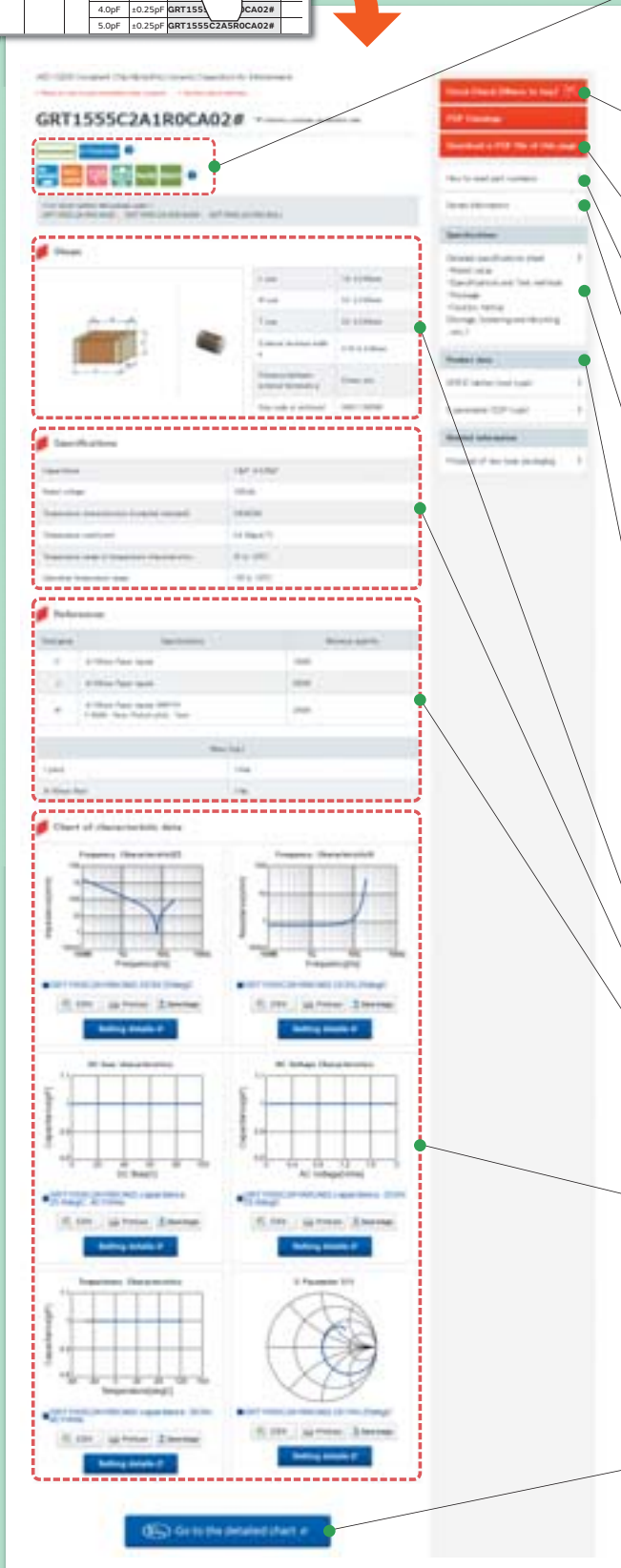

Status and Features Icons

The status and features of products can be checked at once. When ? is clicked, a description of each icon will be displayed

Stock Check (Where to buy)

Reference inventory information from agents and web-based companies.

Data Sheet

The product details page can be output in PDF.

How to read part numbers

Describes the meaning of the part number

Series Information

This links to the introduction page of each series.

Detailed Specifications Sheet

- Rated value
- Specifications and Test Methods
- Package
- Caution, Notice (Storage, Soldering and Mounting,etc.)

Characteristics Data

- The following characteristics data of the main products can be acquired.
- SPICE Netlist (mod type)
 - S parameter (S2P type)
 - Reliability Test Data *Typical data
-
- Shape (Dimensions)
 - Rated Values
-
- Specification by Packaging Code/ Minimum Order Quantity
 - Weight (1 pc/ø180mm reel)

Chart of Characteristic Data

- The main products published characteristic data.
- Frequency characteristics (ESR, Impedance)
 - DC bias characteristics
 - AC voltage characteristics
 - Capacitance - temperature characteristics
 - Calorific property by ripple current

Design Tools SimSurfing

The SimSurfing design tools are useful for displaying the graph, downloading CSV data and overwriting the product number graph.

AEC-Q200 Compliant Chip Multilayer Ceramic Capacitors for Infotainment

GRT Series    

Capacitor meet AEC-Q200 (Grade2 or Grade3).

Features

① This product has cleared test conditions meet AEC-Q200.

This series is designed for use in Car Multimedia, Car Interior, Car Comfort application and General Electronic equipment. It is not appropriate for use in applications critical to passenger safety and car driving function (e.g. ABS, AIRBAG, etc.). Please use the GCM series is in critical applications.

	General Purpose GRM Series Maximum operating temperature: 125°C	AEC-Q200 metted GRT Series Maximum operating temperature: 125°C
Items	Test Method	Test Method
Temperature Cycle	Temperature Cycle: 5 cycles	Temperature Cycle: 1,000 cycles
Humidity Loading	Test temperature: 40±2°C Test humidity: 90 to 95%RH Test time: 500 hours	Test temperature: 85±2°C Test humidity: 80 to 85%RH Test time: 1,000 hours

② Meet AEC-Q200 (Grade2 or Grade3).

105°C product: Grade2.
 85°C product: Grade3.

③ Sn plating is applied to the external electrodes; excellent solderability.

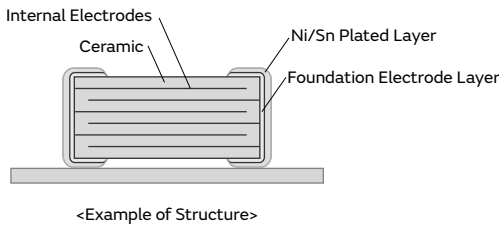

Specifications

Size	0.6×0.3mm to 3.2×2.5mm
Rated Voltage	2.5Vdc to 100Vdc
Capacitance	0.50pF to 100μF
Main Applications	Such as Information and Comfort equipment, car navigation, communication module and entertainment system

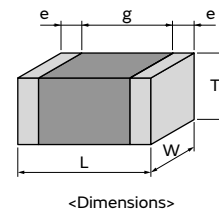

GRT Series
 GCM Series
 GC3 Series
 GCJ Series
 GCD Series
 GCE Series
 NMF Series
 KCM Series
 KC3 Series
 KCA Series
 GCG Series
 △Caution / Notice

GRT Series

GCM Series

GC3 Series

G CJ Series

GCD Series

GCE Series

NMF Series

KCM Series

KC3 Series

KCA Series

GCG Series

⚠Caution/
 Notice

GRT Series Temperature Compensating Type Part Number List

1.0×0.5mm

T max.	Rated Voltage	TC Code	Cap.	Tol.	Part Number
0.55mm	100Vdc	COG	1.0pF	±0.25pF	GRT1555C2A1R0CA02#
			2.0pF	±0.25pF	GRT1555C2A2R0CA02#
			3.0pF	±0.25pF	GRT1555C2A3R0CA02#
			4.0pF	±0.25pF	GRT1555C2A4R0CA02#
			5.0pF	±0.25pF	GRT1555C2A5R0CA02#
			6.0pF	±0.5pF	GRT1555C2A6R0DA02#
			7.0pF	±0.5pF	GRT1555C2A7R0DA02#
			8.0pF	±0.5pF	GRT1555C2A8R0DA02#
			9.0pF	±0.5pF	GRT1555C2A9R0DA02#
			10pF	±5%	GRT1555C2A100JA02#
			12pF	±5%	GRT1555C2A120JA02#
			15pF	±5%	GRT1555C2A150JA02#
			18pF	±5%	GRT1555C2A180JA02#
			22pF	±5%	GRT1555C2A220JA02#
			27pF	±5%	GRT1555C2A270JA02#
			33pF	±5%	GRT1555C2A330JA02#
			39pF	±5%	GRT1555C2A390JA02#
			47pF	±5%	GRT1555C2A470JA02#
			56pF	±5%	GRT1555C2A560JA02#
			68pF	±5%	GRT1555C2A680JA02#
	82pF	±5%	GRT1555C2A820JA02#		
	100pF	±5%	GRT1555C2A101JA02#		
	50Vdc	COG	1.0pF	±0.25pF	GRT1555C1H1R0CA02#
			2.0pF	±0.25pF	GRT1555C1H2R0CA02#
			3.0pF	±0.25pF	GRT1555C1H3R0CA02#
			4.0pF	±0.25pF	GRT1555C1H4R0CA02#
			5.0pF	±0.25pF	GRT1555C1H5R0CA02#
			6.0pF	±0.5pF	GRT1555C1H6R0DA02#
			7.0pF	±0.5pF	GRT1555C1H7R0DA02#
			8.0pF	±0.5pF	GRT1555C1H8R0DA02#
			9.0pF	±0.5pF	GRT1555C1H9R0DA02#
			10pF	±5%	GRT1555C1H100JA02#
			12pF	±5%	GRT1555C1H120JA02#
			15pF	±5%	GRT1555C1H150JA02#
			18pF	±5%	GRT1555C1H180JA02#
			22pF	±5%	GRT1555C1H220JA02#
			27pF	±5%	GRT1555C1H270JA02#
			33pF	±5%	GRT1555C1H330JA02#
			39pF	±5%	GRT1555C1H390JA02#
			47pF	±5%	GRT1555C1H470JA02#
56pF			±5%	GRT1555C1H560JA02#	
68pF			±5%	GRT1555C1H680JA02#	
82pF	±5%	GRT1555C1H820JA02#			
100pF	±5%	GRT1555C1H101JA02#			
120pF	±5%	GRT1555C1H121JA02#			
150pF	±5%	GRT1555C1H151JA02#			
180pF	±5%	GRT1555C1H181JA02#			
220pF	±5%	GRT1555C1H221JA02#			
270pF	±5%	GRT1555C1H271JA02#			
330pF	±5%	GRT1555C1H331JA02#			
390pF	±5%	GRT1555C1H391JA02#			
470pF	±5%	GRT1555C1H471JA02#			

T max.	Rated Voltage	TC Code	Cap.	Tol.	Part Number
0.55mm	50Vdc	COG	560pF	±5%	GRT1555C1H561JA02#
			680pF	±5%	GRT1555C1H681JA02#
			820pF	±5%	GRT1555C1H821JA02#
			1000pF	±5%	GRT1555C1H102JA02#
	25Vdc	COG	10pF	±5%	GRT1555C1E100JA02#
			12pF	±5%	GRT1555C1E120JA02#
			15pF	±5%	GRT1555C1E150JA02#
			18pF	±5%	GRT1555C1E180JA02#
			22pF	±5%	GRT1555C1E220JA02#
			27pF	±5%	GRT1555C1E270JA02#
			33pF	±5%	GRT1555C1E330JA02#
			39pF	±5%	GRT1555C1E390JA02#
			47pF	±5%	GRT1555C1E470JA02#
			56pF	±5%	GRT1555C1E560JA02#
			68pF	±5%	GRT1555C1E680JA02#
			82pF	±5%	GRT1555C1E820JA02#
			100pF	±5%	GRT1555C1E101JA02#
			120pF	±5%	GRT1555C1E121JA02#
			150pF	±5%	GRT1555C1E151JA02#
			180pF	±5%	GRT1555C1E181JA02#
220pF	±5%	GRT1555C1E221JA02#			
270pF	±5%	GRT1555C1E271JA02#			
330pF	±5%	GRT1555C1E331JA02#			
390pF	±5%	GRT1555C1E391JA02#			
470pF	±5%	GRT1555C1E471JA02#			
560pF	±5%	GRT1555C1E561JA02#			
680pF	±5%	GRT1555C1E681JA02#			
820pF	±5%	GRT1555C1E821JA02#			
1000pF	±5%	GRT1555C1E102JA02#			

1.6×0.8mm

T max.	Rated Voltage	TC Code	Cap.	Tol.	Part Number
0.9mm	100Vdc	COG	1.0pF	±0.25pF	GRT1885C2A1R0CA02#
			2.0pF	±0.25pF	GRT1885C2A2R0CA02#
			3.0pF	±0.25pF	GRT1885C2A3R0CA02#
			4.0pF	±0.25pF	GRT1885C2A4R0CA02#
			5.0pF	±0.25pF	GRT1885C2A5R0CA02#
			6.0pF	±0.5pF	GRT1885C2A6R0DA02#
			7.0pF	±0.5pF	GRT1885C2A7R0DA02#
			8.0pF	±0.5pF	GRT1885C2A8R0DA02#
			9.0pF	±0.5pF	GRT1885C2A9R0DA02#
			10pF	±5%	GRT1885C2A100JA02#
			12pF	±5%	GRT1885C2A120JA02#
			15pF	±5%	GRT1885C2A150JA02#
			18pF	±5%	GRT1885C2A180JA02#
			22pF	±5%	GRT1885C2A220JA02#
			27pF	±5%	GRT1885C2A270JA02#
			33pF	±5%	GRT1885C2A330JA02#
39pF	±5%	GRT1885C2A390JA02#			
47pF	±5%	GRT1885C2A470JA02#			
56pF	±5%	GRT1885C2A560JA02#			
68pF	±5%	GRT1885C2A680JA02#			

Part number # indicates the package specification code.

GRT Series Temperature Compensating Type Info-tainment AEC-Q200 Part Number List

(→ 1.6×0.8mm)

T max.	Rated Voltage	TC Code	Cap.	Tol.	Part Number
0.9mm	100Vdc	COG	82pF	±5%	GRT1885C2A820JA02#
			100pF	±5%	GRT1885C2A101JA02#
			120pF	±5%	GRT1885C2A121JA02#
			150pF	±5%	GRT1885C2A151JA02#
			180pF	±5%	GRT1885C2A181JA02#
			220pF	±5%	GRT1885C2A221JA02#
			270pF	±5%	GRT1885C2A271JA02#
			330pF	±5%	GRT1885C2A331JA02#
			390pF	±5%	GRT1885C2A391JA02#
			470pF	±5%	GRT1885C2A471JA02#
			560pF	±5%	GRT1885C2A561JA02#
			680pF	±5%	GRT1885C2A681JA02#
			820pF	±5%	GRT1885C2A821JA02#
			1000pF	±5%	GRT1885C2A102JA02#
			1200pF	±5%	GRT1885C2A122JA02#
	1500pF	±5%	GRT1885C2A152JA02#		
	50Vdc	COG	1.0pF	±0.25pF	GRT1885C1H1R0CA02#
			2.0pF	±0.25pF	GRT1885C1H2R0CA02#
			3.0pF	±0.25pF	GRT1885C1H3R0CA02#
			4.0pF	±0.25pF	GRT1885C1H4R0CA02#
			5.0pF	±0.25pF	GRT1885C1H5R0CA02#
			6.0pF	±0.5pF	GRT1885C1H6R0DA02#
			7.0pF	±0.5pF	GRT1885C1H7R0DA02#
			8.0pF	±0.5pF	GRT1885C1H8R0DA02#
			9.0pF	±0.5pF	GRT1885C1H9R0DA02#
			10pF	±5%	GRT1885C1H100JA02#
			12pF	±5%	GRT1885C1H120JA02#
			15pF	±5%	GRT1885C1H150JA02#
			18pF	±5%	GRT1885C1H180JA02#
			22pF	±5%	GRT1885C1H220JA02#
			27pF	±5%	GRT1885C1H270JA02#
			33pF	±5%	GRT1885C1H330JA02#
			39pF	±5%	GRT1885C1H390JA02#
47pF			±5%	GRT1885C1H470JA02#	
56pF	±5%	GRT1885C1H560JA02#			
68pF	±5%	GRT1885C1H680JA02#			
82pF	±5%	GRT1885C1H820JA02#			
100pF	±5%	GRT1885C1H101JA02#			
120pF	±5%	GRT1885C1H121JA02#			
150pF	±5%	GRT1885C1H151JA02#			
180pF	±5%	GRT1885C1H181JA02#			
220pF	±5%	GRT1885C1H221JA02#			
270pF	±5%	GRT1885C1H271JA02#			
330pF	±5%	GRT1885C1H331JA02#			
390pF	±5%	GRT1885C1H391JA02#			
470pF	±5%	GRT1885C1H471JA02#			
560pF	±5%	GRT1885C1H561JA02#			
680pF	±5%	GRT1885C1H681JA02#			
820pF	±5%	GRT1885C1H821JA02#			
1000pF	±5%	GRT1885C1H102JA02#			
1200pF	±5%	GRT1885C1H122JA02#			
1500pF	±5%	GRT1885C1H152JA02#			
1800pF	±5%	GRT1885C1H182JA02#			
2200pF	±5%	GRT1885C1H222JA02#			

T max.	Rated Voltage	TC Code	Cap.	Tol.	Part Number		
0.9mm	50Vdc	COG	2700pF	±5%	GRT1885C1H272JA02#		
			3300pF	±5%	GRT1885C1H332JA02#		
			3900pF	±5%	GRT1885C1H392JA02#		
			4700pF	±5%	GRT1885C1H472JA02#		
			5600pF	±5%	GRT1885C1H562JA02#		
			6800pF	±5%	GRT1885C1H682JA02#		
			8200pF	±5%	GRT1885C1H822JA02#		
			10000pF	±5%	GRT1885C1H103JA02#		
			25Vdc	COG	560pF	±5%	GRT1885C1E561JA02#
					680pF	±5%	GRT1885C1E681JA02#
	820pF	±5%			GRT1885C1E821JA02#		
	1000pF	±5%			GRT1885C1E102JA02#		
	1200pF	±5%			GRT1885C1E122JA02#		
	1500pF	±5%			GRT1885C1E152JA02#		
	4700pF	±5%			GRT1885C1E472JA02#		
	5600pF	±5%			GRT1885C1E562JA02#		
	50Vdc	COG	6800pF	±5%	GRT1885C1E682JA02#		
			8200pF	±5%	GRT1885C1E822JA02#		
50Vdc	COG	10000pF	±5%	GRT1885C1E103JA02#			

2.0×1.25mm

T max.	Rated Voltage	TC Code	Cap.	Tol.	Part Number
1.35mm	50Vdc	COG	18000pF	±5%	GRT21B5C1H183JA02#
			22000pF	±5%	GRT21B5C1H223JA02#

3.2×1.6mm

T max.	Rated Voltage	TC Code	Cap.	Tol.	Part Number		
1.8mm	50Vdc	COG	56000pF	±5%	GRT31C5C1H563JA02#		
			68000pF	±5%	GRT31C5C1H683JA02#		
			82000pF	±5%	GRT31C5C1H823JA02#		
			0.10μF	±5%	GRT31C5C1H104JA02#		
			0.12μF	±5%	GRT31C5C1E124JA02#		
	25Vdc	COG	0.10μF	±5%	GRT31C5C1E104JA02#		
			0.12μF	±5%	GRT31C5C1E124JA02#		
			16Vdc	COG	0.12μF	±5%	GRT31C5C1C124JA02#

Part number # indicates the package specification code.

GRT Series High Dielectric Constant Type Part Number List

0.6×0.3mm

T max.	Rated Voltage	TC Code	Cap.	Tol.	Part Number		
0.33mm	35Vdc	X5R	0.10μF	±10%	GRT033R6YA104KE01#	D1	
		X7R	470pF	±10%	GRT033R71E471KE01#		
	1000pF		±10%	GRT033R71E102KE01#			
	X6S		470pF	±10%	GRT033C81E471KE01#		
		1000pF	±10%	GRT033C81E102KE01#			
		0.10μF	±10%	GRT033C81E104KE01#	D1		
	X5R	100pF	±10%	GRT033R61E101KE01#			
		220pF	±10%	GRT033R61E221KE01#			
		470pF	±10%	GRT033R61E471KE01#			
		1000pF	±10%	GRT033R61E102KE01#			
		4700pF	±10%	GRT033R61E472KE01#	D1		
		10000pF	±10%	GRT033R61E103KE01#	D1		
		0.10μF	±10%	GRT033R61E104KE01#			
	16Vdc	X6S	0.10μF	±10%	GRT033C81C104KE01#		
			X5R	10000pF	±10%	GRT033R61C103KE01#	
		22000pF		±10%	GRT033R61C223KE01#	D1	
		47000pF		±10%	GRT033R61C473KE01#	D1	
		0.10μF	±10%	GRT033R61C104KE01#	D1		
	10Vdc	X7R	10000pF	±10%	GRT033R71A103KE01#		
			X6S	0.10μF	±10%	GRT033C81A104KE01#	
		X5R		2200pF	±10%	GRT033R61A222KE01#	
				4700pF	±10%	GRT033R61A472KE01#	
				10000pF	±10%	GRT033R61A103KE01#	
		22000pF		±10%	GRT033R61A223KE01#		
		47000pF		±10%	GRT033R61A473KE01#		
		0.10μF		±10%	GRT033R61A104KE01#		
		0.22μF		±10%	GRT033R61A224KE01#	D1	
		6.3Vdc	X7R	2200pF	±10%	GRT033R70J222KE01#	
	4700pF			±10%	GRT033R70J472KE01#		
	10000pF			±10%	GRT033R70J103KE01#		
	X6S		2200pF	±10%	GRT033C80J222KE01#		
			4700pF	±10%	GRT033C80J472KE01#		
			10000pF	±10%	GRT033C80J103KE01#		
			22000pF	±10%	GRT033C80J223KE01#		
			47000pF	±10%	GRT033C80J473KE01#		
			68000pF	±10%	GRT033C80J683KE01#	D1	
0.10μF			±10%	GRT033C80J104KE01#	D1		
0.22μF			±10%	GRT033C80J224KE01#	D1		
X5R			10000pF	±10%	GRT033R60J103KE01#		
			22000pF	±10%	GRT033R60J223KE01#		
	47000pF	±10%	GRT033R60J473KE01#				
	68000pF	±10%	GRT033R60J683KE01#				
	0.10μF	±10%	GRT033R60J104KE01#				
	0.22μF	±10%	GRT033R60J224KE01#	D1			
	0.47μF	±10%	GRT033R60J474KE01#				
4Vdc	X6S	68000pF	±10%	GRT033C80G683KE01#			
		0.10μF	±10%	GRT033C80G104KE01#			
		0.22μF	±20%	GRT033C80G224ME01#	D1		
0.35mm	6.3Vdc	X5R	1.0μF	±20%	GRT033R60J105ME13#		
	4Vdc	X5R	1.0μF	±20%	GRT033R60G105ME13#		

1.0×0.5mm

T max.	Rated Voltage	TC Code	Cap.	Tol.	Part Number				
0.55mm	50Vdc	X7R	220pF	±10%	GRT155R71H221KE01#				
			470pF	±10%	GRT155R71H471KE01#				
			1000pF	±10%	GRT155R71H102KE01#				
			2200pF	±10%	GRT155R71H222KE01#				
			4700pF	±10%	GRT155R71H472KE01#				
			10000pF	±10%	GRT155R71H103KE01#				
			22000pF	±10%	GRT155R71H223KE01#				
			47000pF	±10%	GRT155R71H473KE01#				
			0.10μF	±10%	GRT155R71H104KE01#				
			35Vdc	X6S	0.22μF	±10%	GRT155C8YA224KE01#	D1	
					X5R	0.22μF	±10%	GRT155R6YA224KE01#	D1
						0.47μF	±10%	GRT155R6YA474KE01#	D1
			25Vdc	X7R	10000pF	±10%	GRT155R71E103KE01#		
					22000pF	±10%	GRT155R71E223KE01#		
	47000pF	±10%			GRT155R71E473KE01#				
	0.10μF	±10%			GRT155R71E104KE01#				
	X6S	0.22μF			±10%	GRT155C81E224KE01#			
		X5R			0.22μF	±10%	GRT155R61E224KE01#		
	0.47μF			±10%	GRT155R61E474KE01#				
	1.0μF			±10%	GRT155R61E105KE01#	D1			
	16Vdc			X7R	10000pF	±10%	GRT155R71C103KE01#		
		22000pF			±10%	GRT155R71C223KE01#			
		47000pF	±10%		GRT155R71C473KE01#				
		0.10μF	±10%		GRT155R71C104KE01#				
	X6S	0.47μF	±10%	GRT155C81C474KE01#					
		X5R	0.22μF	±10%	GRT155R61C224KE01#				
	0.47μF		±10%	GRT155R61C474KE01#					
	1.0μF		±10%	GRT155R61C105KE01#					
	10Vdc		X7R	0.22μF	±10%	GRT155R71A224KE01#			
		0.47μF		±10%	GRT155R71A474KE01#				
		X6S		1.0μF	±10%	GRT155C81A105KE01#			
				X5R	0.22μF	±10%	GRT155R61A224KE01#		
		0.47μF	±10%		GRT155R61A474KE01#				
		1.0μF	±10%		GRT155R61A105KE01#				
		2.2μF	±10%		GRT155R61A225KE01#	D1			
		6.3Vdc	X7R	22000pF	±10%	GRT155R70J223KE01#			
	1.0μF			±10%	GRT155R70J105KE01#	D1			
	X6S		0.22μF	±10%	GRT155C80J224KE01#				
			0.47μF	±10%	GRT155C80J474KE01#				
			1.0μF	±10%	GRT155C80J105KE01#	D1			
			2.2μF	±10%	GRT155C80J225KE01#	D1			
			X5R	0.22μF	±10%	GRT155R60J224KE01#			
0.47μF				±10%	GRT155R60J474KE01#				
1.0μF	±10%	GRT155R60J105KE01#							
2.2μF	±10%	GRT155R60J225KE01#							
4Vdc	X7R	1.0μF	±10%	GRT155R70G105KE01#					
0.6mm	35Vdc	X5R	1.0μF	±10%	GRT155R6YA105KE13#	D1			
	25Vdc	X6S	1.0μF	±10%	GRT155C81E105KE13#	D1			
	16Vdc	X6S	1.0μF	±10%	GRT155C81C105KE13#				
	10Vdc	X7S	1.0μF	±10%	GRT155C71A105KE13#				
	6.3Vdc	X5R	4.7μF	±20%	GRT155R60J475ME13#	D1			

Part number # indicates the package specification code.

GRT Series
 GCM Series
 GC3 Series
 GCJ Series
 GCD Series
 GCE Series
 NMF Series
 KCM Series
 KC3 Series
 KCA Series
 GCG Series
 Caution/ Notice

GRT Series High Dielectric Constant Type Info-tainment AEC-Q200 Part Number List

(→ 1.0×0.5mm)

T max.	Rated Voltage	TC Code	Cap.	Tol.	Part Number	
0.6mm	4Vdc	X5R	4.7μF	±20%	GRT155R60G475ME13#	
0.65mm	10Vdc	X5R	4.7μF	±20%	GRT155R61A475ME13#	D1
	6.3Vdc	X6S	4.7μF	±20%	GRT155C80J475ME13#	D1
0.7mm	25Vdc	X5R	2.2μF	±10%	GRT155R61E225KE13#	
	16Vdc	X6S	2.2μF	±10%	GRT155C81C225KE13#	
		X5R	2.2μF	±10%	GRT155R61C225KE13#	
	10Vdc	X7S	2.2μF	±10%	GRT155C71A225KE13#	
		X6S	2.2μF	±10%	GRT155C81A225KE13#	
2.5Vdc	X6S	10μF	±20%	GRT155C80E106ME13#		

1.6×0.8mm

T max.	Rated Voltage	TC Code	Cap.	Tol.	Part Number	
0.9mm	50Vdc	X5R	1.0μF	±10%	GRT188R61H105KE13#	
		X6S	1.0μF	±10%	GRT188C8YA105KE13#	
			X5R	1.0μF	±10%	GRT188R6YA105KE13#
	25Vdc	X7R	1.0μF	±10%	GRT188R71E105KE13#	
			X6S	1.0μF	±10%	GRT188C81E105KE13#
		X5R	1.0μF	±10%	GRT188R61E105KE13#	
	16Vdc	X7R	1.0μF	±10%	GRT188R71C105KE13#	
			X6S	1.0μF	±10%	GRT188C81C105KE13#
		X5R	1.0μF	±10%	GRT188R61C105KE13#	
			2.2μF	±10%	GRT188C81C225KE13#	
	10Vdc	X6S	1.0μF	±10%	GRT188C81A105KE13#	
		X5R	1.0μF	±10%	GRT188R61A105KE01#	
2.2μF			±10%	GRT188R61A225KE13#		
6.3Vdc	X7R	2.2μF	±10%	GRT188R70J225KE13#		
		X6S	4.7μF	±10%	GRT188C80J475KE01#	D1
	X5R	1.0μF	±10%	GRT188R60J105KE01#		
		2.2μF	±10%	GRT188R60J225KE13#		
		4.7μF	±10%	GRT188R60J475KE01#		
		10μF	±20%	GRT188R60J106ME13#		
4Vdc	X6S	1.0μF	±20%	GRT188C80G105ME01#		
		4.7μF	±10%	GRT188C80G475KE01#		
	X5R	10μF	±20%	GRT188C80G106ME13#	D1	
		10μF	±20%	GRT188R60G106ME13#		
0.95mm	25Vdc	X5R	4.7μF	±10%	GRT188R61E475KE13#	
		X6S	4.7μF	±10%	GRT188C81C475KE13#	
	X5R		4.7μF	±10%	GRT188R61C475KE13#	
		10μF	±10%	GRT188R61C106KE13#		
10Vdc	X5R	10μF	±10%	GRT188R61A106KE13#	D1	
2.5Vdc	X5R	22μF	±20%	GRT188R60E226ME13#		
1.0mm	50Vdc	X5R	2.2μF	±10%	GRT188R61H225KE13#	
		X6S	2.2μF	±10%	GRT188C8YA225KE13#	
	35Vdc	X5R	4.7μF	±10%	GRT188R6YA475KE13#	
		X6S	2.2μF	±10%	GRT188C81E225KE13#	
	25Vdc	X6S	4.7μF	±10%	GRT188C81E475KE13#	
			X5R	10μF	±20%	GRT188R61E106ME13#
	16Vdc	X6S	10μF	±20%	GRT188C81C106ME13#	
	10Vdc	X6S	10μF	±20%	GRT188C81A106ME13#	
6.3Vdc	X5R	22μF	±20%	GRT188R60J226ME13#	D1	

T max.	Rated Voltage	TC Code	Cap.	Tol.	Part Number	
1.0mm	4Vdc	X6S	22μF	±20%	GRT188C80G226ME13#	

2.0×1.25mm

T max.	Rated Voltage	TC Code	Cap.	Tol.	Part Number		
1.35mm	50Vdc	X7R	1.0μF	±10%	GRT21BR71H105KE01#		
			X6S	2.2μF	±10%	GRT21BC81E225KA02#	
				4.7μF	±10%	GRT21BC81E475KA02#	
		X5R	2.2μF	±10%	GRT21BR61E225KA02#		
			4.7μF	±10%	GRT21BR61E475KA02#		
			10μF	±10%	GRT21BC81C106KE01#	D1	
	16Vdc	X7R	2.2μF	±10%	GRT21BR71C225KE01#		
			X6S	2.2μF	±10%	GRT21BC81C225KA02#	
				4.7μF	±10%	GRT21BC81C475KA02#	
		X5R	2.2μF	±10%	GRT21BR61C225KA02#		
			4.7μF	±10%	GRT21BR61C475KA02#		
			10μF	±10%	GRT21BR61C106KE01#		
10Vdc	X6S	10μF	±10%	GRT21BC81A106KE01#			
	X5R	10μF	±10%	GRT21BR61A106KE01#			
6.3Vdc	X5R	10μF	±10%	GRT21BR60J106KE01#			
1.4mm	50Vdc	X5R	2.2μF	±10%	GRT21BR61H225KE13#		
			4.7μF	±10%	GRT21BR61H475KE13#		
	35Vdc	X6S	2.2μF	±10%	GRT21BC8YA225KE13#		
			4.7μF	±10%	GRT21BC8YA475KE13#		
	25Vdc	X7R	2.2μF	±10%	GRT21BR71E225KE13#		
			X5R	10μF	±10%	GRT21BR61E106KE13#	
	16Vdc	X7R	4.7μF	±10%	GRT21BR71C475KE13#		
			X5R	4.7μF	±10%	GRT21BR61C475KE13#	
	10Vdc	X7R	4.7μF	±10%	GRT21BR71A475KE13#		
			10μF	±10%	GRT21BR71A106KE13#		
		X5R	4.7μF	±10%	GRT21BR61A475KE13#		
	6.3Vdc	X7R	10μF	±10%	GRT21BR70J106KE13#		
X5R			4.7μF	±10%	GRT21BR60J475KE13#		
X5R		22μF	±20%	GRT21BR61A226ME13#	D1		
1.45mm	25Vdc	X7S	10μF	±10%	GRT21BC71E106KE13#	D1	
			X5R	22μF	±20%	GRT21BR61E226ME13#	
	16Vdc	X5R	22μF	±20%	GRT21BR61C226ME13#		
			10Vdc	X6S	22μF	±20%	GRT21BC81A226ME13#
	6.3Vdc	X5R	47μF	±20%	GRT21BR60J476ME13#	D1	
			47μF	±20%	GRT21BR60G476ME13#		

3.2×1.6mm

T max.	Rated Voltage	TC Code	Cap.	Tol.	Part Number		
1.8mm	50Vdc	X7R	2.2μF	±10%	GRT31CR71H225KE13#		
			X6S	2.2μF	±10%	GRT31CC81H225KE01#	
				X5R	10μF	±10%	GRT31CR61H106KE01#
		35Vdc	X6S	10μF	±10%	GRT31CC8YA106KE01#	
				X5R	10μF	±10%	GRT31CR6YA106KE01#
			X7R	10μF	±10%	GRT31CR71E106KE13#	
	25Vdc	X6S	10μF	±10%	GRT31CC81E106KE01#		
			X5R	10μF	±10%	GRT31CR61E106KE01#	
		X7R	10μF	±10%	GRT31CR71E106KE13#		
			X5R	10μF	±10%	GRT31CR61E106KE01#	

Part number # indicates the package specification code.

GRT Series

GCM Series

GC3 Series

G CJ Series

GCD Series

GCE Series

NMF Series

KCM Series

KC3 Series

KCA Series

GCG Series

⚠Caution/
 Notice

GRT Series High Dielectric Constant Type Part Number List

(→ 3.2×1.6mm)

T max.	Rated Voltage	TC Code	Cap.	Tol.	Part Number		
1.8mm	25Vdc	X5R	22μF	±10%	GRT31CR61E226KE01#		
		X6S	22μF	±10%	GRT31CC81C226KE01#		
			X5R	22μF	±10%	GRT31CR61C226KE01#	
	10Vdc	X6S	22μF	±10%	GRT31CC81A226KE01#		
			X5R	22μF	±10%	GRT31CR61A226KE01#	
				47μF	±10%	GRT31CR61A476KE13#	
	6.3Vdc	X7R	22μF	±10%	GRT31CR70J226KE13#		
			X6S	22μF	±10%	GRT31CC80J226KE01#	
					47μF	±10%	GRT31CC80J476KE13#
		X5R	22μF	±10%	GRT31CR60J226KE01#		
				47μF	±10%	GRT31CR60J476KE13#	
	4Vdc	X6S	22μF	±10%	GRT31CC80G226KE01#		
			47μF	±20%	GRT31CC80G476ME01#		

3.2×2.5mm

T max.	Rated Voltage	TC Code	Cap.	Tol.	Part Number	
2.2mm	25Vdc	X6S	10μF	±10%	GRT32DC81E106KE01#	
		X5R	10μF	±10%	GRT32DR61E106KE01#	
	6.3Vdc	X5R	33μF	±20%	GRT32DR60J336ME01#	
2.7mm	50Vdc	X7R	4.7μF	±10%	GRT32ER71H475KE01#	
		X6S	4.7μF	±10%	GRT32EC81H475KE01#	
	16Vdc	X6S	47μF	±10%	GRT32EC81C476KE13#	D1
	10Vdc	X6S	47μF	±10%	GRT32EC81A476KE13#	
	6.3Vdc	X7R	47μF	±10%	GRT32ER70J476KE13#	
			X6S	47μF	±10%	GRT32EC80J476KE13#
	X5R	100μF	±20%	GRT32ER60J107ME13#		

Chip Multilayer Ceramic Capacitors for Automotive

GCM Series



Capacitor for automotive applications such as power train and safety equipment.

Features

① Ideal for powertrains and safety devices in automotive.

This product can be used for safety devices, such as the drive system control for engine ECU, air bags, and ABS. This product has cleared test conditions more severe than that of general products (GRM Series) even in temperature cycle and humidity load tests.

	General Purpose GRM Series Maximum operating temperature: 125°C	GCM Series for Automotive Maximum operating temperature: 150°C
Items	Test Method	Test Method
Temperature Cycle	Temperature Cycle: 5 cycles	Temperature Cycle: 100 cycles (1,000 cycles for AEC-Q200 conforming products)
Humidity Loading	Test temperature: 40±2°C Test humidity: 90 to 95%RH Test time: 500 hours	Test temperature: 85±2°C Test humidity: 80 to 85%RH Test time: 500 hours (1,000 hours for AEC-Q200 conforming products)

② Can be used at 125°C and 150°C temperatures.

We also offer a lineup for 150°C that can be used in the engine room.

③ Sn plating is applied to the external electrodes; excellent solderability.

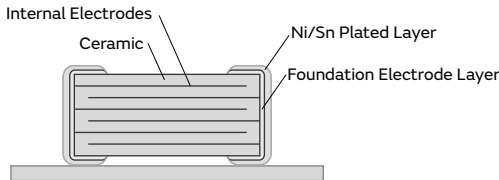

<Example of Structure>

Specifications

Size	0.6×0.3mm to 5.7×5.0mm
Rated Voltage	4Vdc to 1000Vdc
Capacitance	0.10pF to 47μF
Main Applications	Safety equipment, such as drive system control, air bags, and ABS of engine ECU

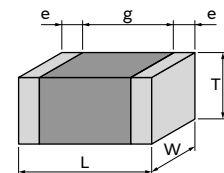

<Dimensions>

GRT Series

GCM Series

GC3 Series

GCC Series

GCD Series

GCE Series

NMF Series

KCM Series

KC3 Series

KCA Series

GCG Series

△Caution / Notice

29

GCM Series Temperature Compensating Type Part Number List

1.0×0.5mm

T max.	Rated Voltage	TC Code	Cap.	Tol.	Part Number			
0.55mm	50Vdc	COG	1.0pF	±0.25pF	GCM1555C1H1R0CA16#			
			2.0pF	±0.25pF	GCM1555C1H2R0CA16#			
			3.0pF	±0.25pF	GCM1555C1H3R0CA16#			
			4.0pF	±0.25pF	GCM1555C1H4R0CA16#			
			5.0pF	±0.25pF	GCM1555C1H5R0CA16#			
			6.0pF	±0.5pF	GCM1555C1H6R0DA16#			
			7.0pF	±0.5pF	GCM1555C1H7R0DA16#			
			8.0pF	±0.5pF	GCM1555C1H8R0DA16#			
			9.0pF	±0.5pF	GCM1555C1H9R0DA16#			
			10pF	±5%	GCM1555C1H100JA16#			
			12pF	±5%	GCM1555C1H120JA16#			
			15pF	±5%	GCM1555C1H150JA16#			
			18pF	±5%	GCM1555C1H180JA16#			
			22pF	±5%	GCM1555C1H220JA16#			
			27pF	±5%	GCM1555C1H270JA16#			
			33pF	±5%	GCM1555C1H330JA16#			
			39pF	±5%	GCM1555C1H390JA16#			
			47pF	±5%	GCM1555C1H470JA16#			
			56pF	±5%	GCM1555C1H560JA16#			
			68pF	±5%	GCM1555C1H680JA16#			
			82pF	±5%	GCM1555C1H820JA16#			
			100pF	±5%	GCM1555C1H101JA16#			
			120pF	±5%	GCM1555C1H121JA16#			
			150pF	±5%	GCM1555C1H151JA16#			
			180pF	±5%	GCM1555C1H181JA16#			
			220pF	±5%	GCM1555C1H221JA16#			
			270pF	±5%	GCM1555C1H271JA16#			
			330pF	±5%	GCM1555C1H331JA16#			
			390pF	±5%	GCM1555C1H391JA16#			
			470pF	±5%	GCM1555C1H471JA16#			
			560pF	±5%	GCM1555C1H561JA16#			
			680pF	±5%	GCM1555C1H681JA16#			
			820pF	±5%	GCM1555C1H821JA16#			
			1000pF	±5%	GCM1555C1H102JA16#			
			X8G			1.0pF	±0.25pF	GCM1555G1H1R0CA16#
						2.0pF	±0.25pF	GCM1555G1H2R0CA16#
3.0pF	±0.25pF	GCM1555G1H3R0CA16#						
4.0pF	±0.25pF	GCM1555G1H4R0CA16#						
5.0pF	±0.25pF	GCM1555G1H5R0CA16#						
12pF	±5%	GCM1555G1H120JA16#						
15pF	±5%	GCM1555G1H150JA16#						
18pF	±5%	GCM1555G1H180JA16#						
22pF	±5%	GCM1555G1H220JA16#						
27pF	±5%	GCM1555G1H270JA16#						
33pF	±5%	GCM1555G1H330JA16#						
39pF	±5%	GCM1555G1H390JA16#						
47pF	±5%	GCM1555G1H470JA16#						
56pF	±5%	GCM1555G1H560JA16#						
68pF	±5%	GCM1555G1H680JA16#						
82pF	±5%	GCM1555G1H820JA16#						
100pF	±5%	GCM1555G1H101JA16#						
120pF	±5%	GCM1555G1H121JA16#						

T max.	Rated Voltage	TC Code	Cap.	Tol.	Part Number
0.55mm	50Vdc	X8G	150pF	±5%	GCM1555G1H151JA16#
			180pF	±5%	GCM1555G1H181JA16#
			220pF	±5%	GCM1555G1H221JA16#
			270pF	±5%	GCM1555G1H271JA16#
			330pF	±5%	GCM1555G1H331JA16#
			390pF	±5%	GCM1555G1H391JA16#
			470pF	±5%	GCM1555G1H471JA16#
			560pF	±5%	GCM1555G1H561JA16#
			680pF	±5%	GCM1555G1H681JA16#
			820pF	±5%	GCM1555G1H821JA16#
			1000pF	±5%	GCM1555G1H102JA16#

1.6×0.8mm

T max.	Rated Voltage	TC Code	Cap.	Tol.	Part Number		
0.9mm	100Vdc	COG	1.0pF	±0.25pF	GCM1885C2A1R0CA16#		
			2.0pF	±0.25pF	GCM1885C2A2R0CA16#		
			3.0pF	±0.25pF	GCM1885C2A3R0CA16#		
			4.0pF	±0.25pF	GCM1885C2A4R0CA16#		
			5.0pF	±0.25pF	GCM1885C2A5R0CA16#		
			6.0pF	±0.5pF	GCM1885C2A6R0DA16#		
			7.0pF	±0.5pF	GCM1885C2A7R0DA16#		
			8.0pF	±0.5pF	GCM1885C2A8R0DA16#		
			9.0pF	±0.5pF	GCM1885C2A9R0DA16#		
			10pF	±5%	GCM1885C2A100JA16#		
			12pF	±5%	GCM1885C2A120JA16#		
			15pF	±5%	GCM1885C2A150JA16#		
			18pF	±5%	GCM1885C2A180JA16#		
			22pF	±5%	GCM1885C2A220JA16#		
			27pF	±5%	GCM1885C2A270JA16#		
			33pF	±5%	GCM1885C2A330JA16#		
			39pF	±5%	GCM1885C2A390JA16#		
			47pF	±5%	GCM1885C2A470JA16#		
			56pF	±5%	GCM1885C2A560JA16#		
			68pF	±5%	GCM1885C2A680JA16#		
			82pF	±5%	GCM1885C2A820JA16#		
			100pF	±5%	GCM1885C2A101JA16#		
			120pF	±5%	GCM1885C2A121JA16#		
			150pF	±5%	GCM1885C2A151JA16#		
			180pF	±5%	GCM1885C2A181JA16#		
			220pF	±5%	GCM1885C2A221JA16#		
			270pF	±5%	GCM1885C2A271JA16#		
			330pF	±5%	GCM1885C2A331JA16#		
			390pF	±5%	GCM1885C2A391JA16#		
			470pF	±5%	GCM1885C2A471JA16#		
			560pF	±5%	GCM1885C2A561JA16#		
			680pF	±5%	GCM1885C2A681JA16#		
			820pF	±5%	GCM1885C2A821JA16#		
			1000pF	±5%	GCM1885C2A102JA16#		
			1200pF	±5%	GCM1885C2A122JA16#		
			1500pF	±5%	GCM1885C2A152JA16#		
		U2J			1000pF	±5%	GCM1887U2A102JA16#
					1200pF	±5%	GCM1887U2A122JA16#

Part number # indicates the package specification code.

GRT Series
 GCM Series
 GC3 Series
 GCJ Series
 GCD Series
 GCE Series
 NMF Series
 KCM Series
 KC3 Series
 KCA Series
 GCG Series
 Caution/Notice

GCM Series Temperature Compensating Type Part Number List

(→ 1.6×0.8mm)

T max.	Rated Voltage	TC Code	Cap.	Tol.	Part Number
0.9mm	100Vdc	U2J	1500pF	±5%	GCM1887U2A152JA16#
			1800pF	±5%	GCM1887U2A182JA16#
			2200pF	±5%	GCM1887U2A222JA16#
			2700pF	±5%	GCM1887U2A272JA16#
			3300pF	±5%	GCM1887U2A332JA16#
			3900pF	±5%	GCM1887U2A392JA16#
			4700pF	±5%	GCM1887U2A472JA16#
			5600pF	±5%	GCM1887U2A562JA16#
			6800pF	±5%	GCM1887U2A682JA16#
			8200pF	±5%	GCM1887U2A822JA16#
			10000pF	±5%	GCM1887U2A103JA16#
			50Vdc	COG	1.0pF
2.0pF	±0.25pF	GCM1885C1H2R0CA16#			
3.0pF	±0.25pF	GCM1885C1H3R0CA16#			
4.0pF	±0.25pF	GCM1885C1H4R0CA16#			
5.0pF	±0.25pF	GCM1885C1H5R0CA16#			
6.0pF	±0.5pF	GCM1885C1H6R0DA16#			
7.0pF	±0.5pF	GCM1885C1H7R0DA16#			
8.0pF	±0.5pF	GCM1885C1H8R0DA16#			
9.0pF	±0.5pF	GCM1885C1H9R0DA16#			
10pF	±5%	GCM1885C1H100JA16#			
12pF	±5%	GCM1885C1H120JA16#			
15pF	±5%	GCM1885C1H150JA16#			
18pF	±5%	GCM1885C1H180JA16#			
22pF	±5%	GCM1885C1H220JA16#			
27pF	±5%	GCM1885C1H270JA16#			
33pF	±5%	GCM1885C1H330JA16#			
39pF	±5%	GCM1885C1H390JA16#			
47pF	±5%	GCM1885C1H470JA16#			
56pF	±5%	GCM1885C1H560JA16#			
68pF	±5%	GCM1885C1H680JA16#			
82pF	±5%	GCM1885C1H820JA16#			
100pF	±5%	GCM1885C1H101JA16#			
120pF	±5%	GCM1885C1H121JA16#			
150pF	±5%	GCM1885C1H151JA16#			
180pF	±5%	GCM1885C1H181JA16#			
220pF	±5%	GCM1885C1H221JA16#			
270pF	±5%	GCM1885C1H271JA16#			
330pF	±5%	GCM1885C1H331JA16#			
390pF	±5%	GCM1885C1H391JA16#			
470pF	±5%	GCM1885C1H471JA16#			
560pF	±5%	GCM1885C1H561JA16#			
680pF	±5%	GCM1885C1H681JA16#			
820pF	±5%	GCM1885C1H821JA16#			
1000pF	±5%	GCM1885C1H102JA16#			
1200pF	±5%	GCM1885C1H122JA16#			
1500pF	±5%	GCM1885C1H152JA16#			
1800pF	±5%	GCM1885C1H182JA16#			
2200pF	±5%	GCM1885C1H222JA16#			
2700pF	±5%	GCM1885C1H272JA16#			
3300pF	±5%	GCM1885C1H332JA16#			
3900pF	±5%	GCM1885C1H392JA16#			
U2J	100Vdc	1000pF			±5%
		1200pF	±5%	GCM1887U1H122JA16#	

T max.	Rated Voltage	TC Code	Cap.	Tol.	Part Number
0.9mm	50Vdc	U2J	1500pF	±5%	GCM1887U1H152JA16#
			1800pF	±5%	GCM1887U1H182JA16#
			2200pF	±5%	GCM1887U1H222JA16#
			2700pF	±5%	GCM1887U1H272JA16#
			3300pF	±5%	GCM1887U1H332JA16#
			3900pF	±5%	GCM1887U1H392JA16#
			4700pF	±5%	GCM1887U1H472JA16#
			5600pF	±5%	GCM1887U1H562JA16#
			6800pF	±5%	GCM1887U1H682JA16#
			8200pF	±5%	GCM1887U1H822JA16#
			10000pF	±5%	GCM1887U1H103JA16#

2.0×1.25mm

T max.	Rated Voltage	TC Code	Cap.	Tol.	Part Number		
0.7mm	100Vdc	COG	100pF	±5%	GCM2165C2A101JA16#		
			120pF	±5%	GCM2165C2A121JA16#		
			150pF	±5%	GCM2165C2A151JA16#		
			180pF	±5%	GCM2165C2A181JA16#		
			220pF	±5%	GCM2165C2A221JA16#		
			270pF	±5%	GCM2165C2A271JA16#		
			330pF	±5%	GCM2165C2A331JA16#		
			390pF	±5%	GCM2165C2A391JA16#		
			470pF	±5%	GCM2165C2A471JA16#		
			560pF	±5%	GCM2165C2A561JA16#		
			680pF	±5%	GCM2165C2A681JA16#		
			820pF	±5%	GCM2165C2A821JA16#		
			1000pF	±5%	GCM2165C2A102JA16#		
			1200pF	±5%	GCM2165C2A122JA16#		
			1500pF	±5%	GCM2165C2A152JA16#		
			1800pF	±5%	GCM2165C2A182JA16#		
			2200pF	±5%	GCM2165C2A222JA16#		
			2700pF	±5%	GCM2165C2A272JA16#		
			3300pF	±5%	GCM2165C2A332JA16#		
			50Vdc	COG	4700pF	±5%	GCM2165C1H472JA16#
					5600pF	±5%	GCM2165C1H562JA16#
0.95mm	100Vdc	ZLM	1000pF	±10%	GCM2199E2A102KA05#		
				±20%	GCM2199E2A102MA05#		
			1100pF	±10%	GCM2199E2A112KA05#		
				±20%	GCM2199E2A112MA05#		
			1200pF	±10%	GCM2199E2A122KA05#		
				±20%	GCM2199E2A122MA05#		
			1300pF	±10%	GCM2199E2A132KA05#		
				±20%	GCM2199E2A132MA05#		
			1500pF	±10%	GCM2199E2A152KA05#		
				±20%	GCM2199E2A152MA05#		
			80Vdc	COG	15000pF	±5%	GCM2195C1K153JA16#
			63Vdc	COG	15000pF	±5%	GCM2195C1J153JA16#
50Vdc	COG	5600pF	±5%	GCM2195C1H562JA16#			
		6800pF	±5%	GCM2195C1H682JA16#			
		8200pF	±5%	GCM2195C1H822JA16#			
		10000pF	±5%	GCM2195C1H103JA16#			
		12000pF	±5%	GCM2195C1H123JA16#			
		15000pF	±5%	GCM2195C1H153JA16#			

Part number # indicates the package specification code.

GCM Series Temperature Compensating Type Part Number List

(→ 2.0×1.25mm)

T max.	Rated Voltage	TC Code	Cap.	Tol.	Part Number		
1.0mm	630Vdc	COG	10pF	±5%	GCM21A5C2J100JX01#		
			12pF	±5%	GCM21A5C2J120JX01#		
			15pF	±5%	GCM21A5C2J150JX01#		
			18pF	±5%	GCM21A5C2J180JX01#		
			22pF	±5%	GCM21A5C2J220JX01#		
			27pF	±5%	GCM21A5C2J270JX01#		
			33pF	±5%	GCM21A5C2J330JX01#		
			39pF	±5%	GCM21A5C2J390JX01#		
			47pF	±5%	GCM21A5C2J470JX01#		
			56pF	±5%	GCM21A5C2J560JX01#		
			68pF	±5%	GCM21A5C2J680JX01#		
			82pF	±5%	GCM21A5C2J820JX01#		
			100pF	±5%	GCM21A5C2J101JX01#		
			120pF	±5%	GCM21A5C2J121JX01#		
			150pF	±5%	GCM21A5C2J151JX01#		
			180pF	±5%	GCM21A5C2J181JX01#		
			220pF	±5%	GCM21A5C2J221JX01#		
			270pF	±5%	GCM21A5C2J271JX01#		
			330pF	±5%	GCM21A5C2J331JX01#		
			390pF	±5%	GCM21A5C2J391JX01#		
			470pF	±5%	GCM21A5C2J471JX01#		
			560pF	±5%	GCM21A5C2J561JX01#		
			250Vdc	COG	10pF	±5%	GCM21A5C2E100JX01#
					12pF	±5%	GCM21A5C2E120JX01#
					15pF	±5%	GCM21A5C2E150JX01#
					18pF	±5%	GCM21A5C2E180JX01#
					22pF	±5%	GCM21A5C2E220JX01#
					27pF	±5%	GCM21A5C2E270JX01#
					33pF	±5%	GCM21A5C2E330JX01#
					39pF	±5%	GCM21A5C2E390JX01#
	47pF	±5%			GCM21A5C2E470JX01#		
	56pF	±5%			GCM21A5C2E560JX01#		
	68pF	±5%			GCM21A5C2E680JX01#		
	82pF	±5%			GCM21A5C2E820JX01#		
	100pF	±5%			GCM21A5C2E101JX01#		
	120pF	±5%			GCM21A5C2E121JX01#		
	150pF	±5%			GCM21A5C2E151JX01#		
	180pF	±5%			GCM21A5C2E181JX01#		
	220pF	±5%			GCM21A5C2E221JX01#		
	270pF	±5%			GCM21A5C2E271JX01#		
	330pF	±5%			GCM21A5C2E331JX01#		
	390pF	±5%			GCM21A5C2E391JX01#		
	470pF	±5%	GCM21A5C2E471JX01#				
	560pF	±5%	GCM21A5C2E561JX01#				
	680pF	±5%	GCM21A5C2E681JX01#				
	820pF	±5%	GCM21A5C2E821JX01#				
	1000pF	±5%	GCM21A5C2E102JX01#				
	1200pF	±5%	GCM21A5C2E122JX01#				
	1500pF	±5%	GCM21A5C2E152JX01#				
	1800pF	±5%	GCM21A5C2E182JX01#				
2200pF	±5%	GCM21A5C2E222JX01#					
2700pF	±5%	GCM21A5C2E272JX01#					
U2J	COG	100pF	±5%	GCM21A7U2E101JX01#			
		120pF	±5%	GCM21A7U2E121JX01#			

T max.	Rated Voltage	TC Code	Cap.	Tol.	Part Number			
1.0mm	250Vdc	U2J	150pF	±5%	GCM21A7U2E151JX01#			
			180pF	±5%	GCM21A7U2E181JX01#			
			220pF	±5%	GCM21A7U2E221JX01#			
			270pF	±5%	GCM21A7U2E271JX01#			
			330pF	±5%	GCM21A7U2E331JX01#			
			390pF	±5%	GCM21A7U2E391JX01#			
			470pF	±5%	GCM21A7U2E471JX01#			
			560pF	±5%	GCM21A7U2E561JX01#			
			680pF	±5%	GCM21A7U2E681JX01#			
			820pF	±5%	GCM21A7U2E821JX01#			
			1000pF	±5%	GCM21A7U2E102JX01#			
			1200pF	±5%	GCM21A7U2E122JX01#			
			1500pF	±5%	GCM21A7U2E152JX01#			
			1800pF	±5%	GCM21A7U2E182JX01#			
			2200pF	±5%	GCM21A7U2E222JX01#			
			1.4mm	80Vdc	COG	1800pF	±5%	GCM21B5C1K183JA16#
						2000pF	±5%	GCM21B5C1K203JA16#
						2200pF	±5%	GCM21B5C1K223JA16#
				63Vdc	COG	1800pF	±5%	GCM21B5C1J183JA16#
						2000pF	±5%	GCM21B5C1J203JA16#
2200pF	±5%	GCM21B5C1J223JA16#						
50Vdc	COG	1800pF	±5%	GCM21B5C1H183JA16#				
		2200pF	±5%	GCM21B5C1H223JA16#				
		1.45mm	630Vdc	COG	680pF	±5%	GCM21B5C2J681JX03#	
820pF	±5%				GCM21B5C2J821JX03#			
1000pF	±5%				GCM21B5C2J102JX03#			
1200pF	±5%				GCM21B5C2J122JX03#			
250Vdc	COG			3300pF	±5%	GCM21B5C2E332JX01#		
				3900pF	±5%	GCM21B5C2E392JX01#		
U2J	COG	2700pF	±5%	GCM21B7U2E272JX03#				
		3300pF	±5%	GCM21B7U2E332JX03#				
		3900pF	±5%	GCM21B7U2E392JX03#				
		4700pF	±5%	GCM21B7U2E472JX03#				
U2J	COG	2700pF	±5%	GCM21B7U2E272JX03#				
		5600pF	±5%	GCM21B7U2E562JX03#				

3.2×1.6mm

T max.	Rated Voltage	TC Code	Cap.	Tol.	Part Number		
0.95mm	100Vdc	COG	3900pF	±5%	GCM3195C2A392JA16#		
			4700pF	±5%	GCM3195C2A472JA16#		
			5600pF	±5%	GCM3195C2A562JA16#		
			6800pF	±5%	GCM3195C2A682JA16#		
			8200pF	±5%	GCM3195C2A822JA16#		
			10000pF	±5%	GCM3195C2A103JA16#		
			80Vdc	COG	3300pF	±5%	GCM3195C1K333JA16#
					10pF	±5%	GCM31A5C3A100JX01#
					12pF	±5%	GCM31A5C3A120JX01#
					15pF	±5%	GCM31A5C3A150JX01#
1.0mm	1000Vdc	COG	18pF	±5%	GCM31A5C3A180JX01#		
			22pF	±5%	GCM31A5C3A220JX01#		
			27pF	±5%	GCM31A5C3A270JX01#		
			33pF	±5%	GCM31A5C3A330JX01#		

Part number # indicates the package specification code.

GRT Series
 GCM Series
 GC3 Series
 GCJ Series
 GCD Series
 GCE Series
 NMF Series
 KCM Series
 KC3 Series
 KCA Series
 GCG Series
 Caution/Notice

GCM Series Temperature Compensating Type Part Number List

(→ 3.2×1.6mm)

T max.	Rated Voltage	TC Code	Cap.	Tol.	Part Number	T max.	Rated Voltage	TC Code	Cap.	Tol.	Part Number		
1.0mm	1000Vdc	COG	39pF	±5%	GCM31A5C3A390JX01#	1.0mm	630Vdc	COG	560pF	±5%	GCM31A5C2J561JX01#		
			47pF	±5%	GCM31A5C3A470JX01#				680pF	±5%	GCM31A5C2J681JX01#		
			56pF	±5%	GCM31A5C3A560JX01#				820pF	±5%	GCM31A5C2J821JX01#		
			68pF	±5%	GCM31A5C3A680JX01#				1000pF	±5%	GCM31A5C2J102JX01#		
			82pF	±5%	GCM31A5C3A820JX01#				1200pF	±5%	GCM31A5C2J122JX01#		
			100pF	±5%	GCM31A5C3A101JX01#				1500pF	±5%	GCM31A5C2J152JX01#		
			120pF	±5%	GCM31A5C3A121JX01#				1800pF	±5%	GCM31A5C2J182JX01#		
			150pF	±5%	GCM31A5C3A151JX01#				U2J	10pF	±5%	GCM31A7U2J100JX01#	
			180pF	±5%	GCM31A5C3A181JX01#					12pF	±5%	GCM31A7U2J120JX01#	
			220pF	±5%	GCM31A5C3A221JX01#					15pF	±5%	GCM31A7U2J150JX01#	
			270pF	±5%	GCM31A5C3A271JX01#					18pF	±5%	GCM31A7U2J180JX01#	
			330pF	±5%	GCM31A5C3A331JX01#					22pF	±5%	GCM31A7U2J220JX01#	
			390pF	±5%	GCM31A5C3A391JX01#					27pF	±5%	GCM31A7U2J270JX01#	
			470pF	±5%	GCM31A5C3A471JX01#					33pF	±5%	GCM31A7U2J330JX01#	
			U2J	10pF	±5%					GCM31A7U3A100JX01#	39pF	±5%	GCM31A7U2J390JX01#
				12pF	±5%					GCM31A7U3A120JX01#	47pF	±5%	GCM31A7U2J470JX01#
				15pF	±5%					GCM31A7U3A150JX01#	56pF	±5%	GCM31A7U2J560JX01#
				18pF	±5%					GCM31A7U3A180JX01#	68pF	±5%	GCM31A7U2J680JX01#
				22pF	±5%					GCM31A7U3A220JX01#	82pF	±5%	GCM31A7U2J820JX01#
				27pF	±5%					GCM31A7U3A270JX01#	100pF	±5%	GCM31A7U2J101JX01#
				33pF	±5%					GCM31A7U3A330JX01#	120pF	±5%	GCM31A7U2J121JX01#
				39pF	±5%				GCM31A7U3A390JX01#	150pF	±5%	GCM31A7U2J151JX01#	
				47pF	±5%				GCM31A7U3A470JX01#	180pF	±5%	GCM31A7U2J181JX01#	
				56pF	±5%				GCM31A7U3A560JX01#	220pF	±5%	GCM31A7U2J221JX01#	
				68pF	±5%				GCM31A7U3A680JX01#	270pF	±5%	GCM31A7U2J271JX01#	
				82pF	±5%				GCM31A7U3A820JX01#	330pF	±5%	GCM31A7U2J331JX01#	
				100pF	±5%				GCM31A7U3A101JX01#	390pF	±5%	GCM31A7U2J391JX01#	
	120pF	±5%		GCM31A7U3A121JX01#	470pF		±5%	GCM31A7U2J471JX01#					
	150pF	±5%		GCM31A7U3A151JX01#	560pF		±5%	GCM31A7U2J561JX01#					
	180pF	±5%		GCM31A7U3A181JX01#	680pF		±5%	GCM31A7U2J681JX01#					
	220pF	±5%		GCM31A7U3A221JX01#	820pF		±5%	GCM31A7U2J821JX01#					
	270pF	±5%		GCM31A7U3A271JX01#	1000pF		±5%	GCM31A7U2J102JX01#					
	330pF	±5%		GCM31A7U3A331JX01#	1200pF		±5%	GCM31A7U2J122JX01#					
	630Vdc	COG		10pF	±5%		GCM31A5C2J100JX01#	250Vdc	COG	10pF	±5%	GCM31A5C2E100JX01#	
			12pF	±5%	GCM31A5C2J120JX01#		12pF			±5%	GCM31A5C2E120JX01#		
			15pF	±5%	GCM31A5C2J150JX01#		15pF			±5%	GCM31A5C2E150JX01#		
			18pF	±5%	GCM31A5C2J180JX01#		18pF			±5%	GCM31A5C2E180JX01#		
			22pF	±5%	GCM31A5C2J220JX01#		22pF			±5%	GCM31A5C2E220JX01#		
			27pF	±5%	GCM31A5C2J270JX01#		27pF			±5%	GCM31A5C2E270JX01#		
			33pF	±5%	GCM31A5C2J330JX01#		33pF			±5%	GCM31A5C2E330JX01#		
			39pF	±5%	GCM31A5C2J390JX01#		39pF			±5%	GCM31A5C2E390JX01#		
			47pF	±5%	GCM31A5C2J470JX01#		47pF			±5%	GCM31A5C2E470JX01#		
			56pF	±5%	GCM31A5C2J560JX01#		56pF			±5%	GCM31A5C2E560JX01#		
			68pF	±5%	GCM31A5C2J680JX01#		68pF			±5%	GCM31A5C2E680JX01#		
			82pF	±5%	GCM31A5C2J820JX01#		82pF			±5%	GCM31A5C2E820JX01#		
			100pF	±5%	GCM31A5C2J101JX01#		100pF			±5%	GCM31A5C2E101JX01#		
		120pF	±5%	GCM31A5C2J121JX01#	120pF		±5%	GCM31A5C2E121JX01#					
150pF		±5%	GCM31A5C2J151JX01#	150pF	±5%	GCM31A5C2E151JX01#							
180pF		±5%	GCM31A5C2J181JX01#	180pF	±5%	GCM31A5C2E181JX01#							
220pF		±5%	GCM31A5C2J221JX01#	220pF	±5%	GCM31A5C2E221JX01#							
270pF		±5%	GCM31A5C2J271JX01#	270pF	±5%	GCM31A5C2E271JX01#							
330pF		±5%	GCM31A5C2J331JX01#	330pF	±5%	GCM31A5C2E331JX01#							
390pF		±5%	GCM31A5C2J391JX01#	390pF	±5%	GCM31A5C2E391JX01#							
470pF	±5%	GCM31A5C2J471JX01#	470pF	±5%	GCM31A5C2E471JX01#								

GRT Series
 GCM Series
 GC3 Series
 GCJ Series
 GCD Series
 GCE Series
 NMF Series
 KCM Series
 KC3 Series
 KCA Series
 GCG Series
 ⚠Caution / Notice

Part number # indicates the package specification code.

GCM Series Temperature Compensating Type Part Number List

(→ 3.2×1.6mm)

T max.	Rated Voltage	TC Code	Cap.	Tol.	Part Number			
1.0mm	250Vdc	COG	330pF	±5%	GCM31A5C2E331JX01#			
			390pF	±5%	GCM31A5C2E391JX01#			
			470pF	±5%	GCM31A5C2E471JX01#			
			560pF	±5%	GCM31A5C2E561JX01#			
			680pF	±5%	GCM31A5C2E681JX01#			
			820pF	±5%	GCM31A5C2E821JX01#			
			1000pF	±5%	GCM31A5C2E102JX01#			
			1200pF	±5%	GCM31A5C2E122JX01#			
			1500pF	±5%	GCM31A5C2E152JX01#			
			1800pF	±5%	GCM31A5C2E182JX01#			
			2200pF	±5%	GCM31A5C2E222JX01#			
			2700pF	±5%	GCM31A5C2E272JX01#			
			3300pF	±5%	GCM31A5C2E332JX01#			
			3900pF	±5%	GCM31A5C2E392JX01#			
			4700pF	±5%	GCM31A5C2E472JX01#			
			5600pF	±5%	GCM31A5C2E562JX01#			
			6800pF	±5%	GCM31A5C2E682JX01#			
			U2J	2700pF	±5%	GCM31A7U2E272JX01#		
		3300pF		±5%	GCM31A7U2E332JX01#			
		3900pF		±5%	GCM31A7U2E392JX01#			
		4700pF		±5%	GCM31A7U2E472JX01#			
		5600pF		±5%	GCM31A7U2E562JX01#			
		1.25mm		1000Vdc	COG	560pF	±5%	GCM31B5C3A561JX01#
						680pF	±5%	GCM31B5C3A681JX01#
						390pF	±5%	GCM31B7U3A391JX01#
					U2J	470pF	±5%	GCM31B7U3A471JX01#
						560pF	±5%	GCM31B7U3A561JX01#
			680pF			±5%	GCM31B7U3A681JX01#	
630Vdc	COG		2200pF	±5%	GCM31B5C2J222JX01#			
			2700pF	±5%	GCM31B5C2J272JX01#			
			U2J	2700pF	±5%	GCM31B7U2J272JX01#		
	3300pF			±5%	GCM31B7U2J332JX01#			
	250Vdc			COG	8200pF	±5%	GCM31B5C2E822JX01#	
			10000pF		±5%	GCM31B5C2E103JX01#		
12000pF		±5%	GCM31B5C2E123JX01#					
U2J		6800pF	±5%	GCM31B7U2E682JX01#				
		8200pF	±5%	GCM31B7U2E822JX01#				
		10000pF	±5%	GCM31B7U2E103JX01#				
1.8mm	1000Vdc	COG	820pF	±5%	GCM31C5C3A821JX03#			
			1000pF	±5%	GCM31C5C3A102JX03#			
		U2J	820pF	±5%	GCM31C7U3A821JX03#			
			1000pF	±5%	GCM31C7U3A102JX03#			
	630Vdc	COG	3300pF	±5%	GCM31C5C2J332JX03#			
			U2J	3900pF	±5%	GCM31C7U2J392JX03#		
		4700pF		±5%	GCM31C7U2J472JX03#			
	250Vdc	COG	15000pF	±5%	GCM31C5C2E153JX03#			

T max.	Rated Voltage	TC Code	Cap.	Tol.	Part Number
1.0mm	630Vdc	U2J	2200pF	±5%	GCM32A7U2J222JX01#
1.25mm	1000Vdc	U2J	1200pF	±5%	GCM32B7U3A122JX01#
	630Vdc	U2J	5600pF	±5%	GCM32B7U2J562JX01#
1.5mm	1000Vdc	U2J	1500pF	±5%	GCM32Q7U3A152JX01#
	630Vdc	U2J	6800pF	±5%	GCM32Q7U2J682JX01#
2.0mm	1000Vdc	U2J	1800pF	±5%	GCM32D7U3A182JX01#
			2200pF	±5%	GCM32D7U3A222JX01#
	630Vdc	U2J	8200pF	±5%	GCM32D7U2J822JX01#
			10000pF	±5%	GCM32D7U2J103JX01#

4.5×3.2mm

T max.	Rated Voltage	TC Code	Cap.	Tol.	Part Number
1.5mm	1000Vdc	U2J	2700pF	±5%	GCM43Q7U3A272JX01#
			3300pF	±5%	GCM43Q7U3A332JX01#
	630Vdc	U2J	12000pF	±5%	GCM43Q7U2J123JX01#
2.0mm	1000Vdc	U2J	3900pF	±5%	GCM43D7U3A392JX01#
			4700pF	±5%	GCM43D7U3A472JX01#
			630Vdc	U2J	15000pF
	18000pF	±5%			GCM43D7U2J183JX01#
	22000pF	±5%	GCM43D7U2J223JX01#		

5.7×5.0mm

T max.	Rated Voltage	TC Code	Cap.	Tol.	Part Number
1.5mm	1000Vdc	U2J	5600pF	±5%	GCM55Q7U3A562JX01#
			6800pF	±5%	GCM55Q7U3A682JX01#
	630Vdc	U2J	27000pF	±5%	GCM55Q7U2J273JX01#
2.0mm	1000Vdc	U2J	8200pF	±5%	GCM55D7U3A822JX01#
			10000pF	±5%	GCM55D7U3A103JX01#
			630Vdc	U2J	33000pF
	39000pF	±5%			GCM55D7U2J393JX01#
	47000pF	±5%	GCM55D7U2J473JX01#		

3.2×2.5mm

T max.	Rated Voltage	TC Code	Cap.	Tol.	Part Number
1.0mm	630Vdc	U2J	1200pF	±5%	GCM32A7U2J122JX01#
			1500pF	±5%	GCM32A7U2J152JX01#
			1800pF	±5%	GCM32A7U2J182JX01#

Part number # indicates the package specification code.

GRT Series
 GCM Series
 GC3 Series
 GCJ Series
 GCD Series
 GCE Series
 NMF Series
 KCM Series
 KC3 Series
 KCA Series
 GCG Series
 Caution/ Notice

GCM Series High Dielectric Constant Type Part Number List

0.6×0.3mm

T max.	Rated Voltage	TC Code	Cap.	Tol.	Part Number
0.33mm	25Vdc	X7R	100pF	±10%	GCM033R71E101KA03#
			150pF	±10%	GCM033R71E151KA03#
			220pF	±10%	GCM033R71E221KA03#
			330pF	±10%	GCM033R71E331KA03#
			470pF	±10%	GCM033R71E471KA03#
			680pF	±10%	GCM033R71E681KA03#
			1000pF	±10%	GCM033R71E102KA03#
			1500pF	±10%	GCM033R71E152KA03#
			2200pF	±10%	GCM033R71E222KE02#
			3300pF	±10%	GCM033R71E332KE02#
	16Vdc	X7R	330pF	±10%	GCM033R71C331KA03#
			680pF	±10%	GCM033R71C681KA03#
			2200pF	±10%	GCM033R71C222KA55#
			3300pF	±10%	GCM033R71C332KA55#
			10Vdc	X7R	4700pF
6800pF	±10%	GCM033R71A682KA03#			
10000pF	±10%	GCM033R71A103KA03#			

1.0×0.5mm

T max.	Rated Voltage	TC Code	Cap.	Tol.	Part Number		
0.55mm	100Vdc	X7R	220pF	±10%	GCM155R72A221KA37#		
			330pF	±10%	GCM155R72A331KA37#		
			470pF	±10%	GCM155R72A471KA37#		
			680pF	±10%	GCM155R72A681KA37#		
			1000pF	±10%	GCM155R72A102KA37#		
			1500pF	±10%	GCM155R72A152KA37#		
			2200pF	±10%	GCM155R72A222KA37#		
			3300pF	±10%	GCM155R72A332KA37#		
			4700pF	±10%	GCM155R72A472KA37#		
			50Vdc	X8L	33000pF	±10%	GCM155L8EH333KE07#
					47000pF	±10%	GCM155L8EH473KE07#
					68000pF	±10%	GCM155L8EH683KE07#
					0.10μF	±10%	GCM155L8EH104KE07#
					X7R	220pF	±10%
				330pF		±10%	GCM155R71H331KA37#
	470pF	±10%		GCM155R71H471KA37#			
	680pF	±10%		GCM155R71H681KA37#			
	1000pF	±10%		GCM155R71H102KA37#			
	1500pF	±10%		GCM155R71H152KA37#			
	2200pF	±10%	GCM155R71H222KA37#				
	3300pF	±10%	GCM155R71H332KA37#				
	4700pF	±10%	GCM155R71H472KA37#				
	6800pF	±10%	GCM155R71H682KA55#				
	10000pF	±10%	GCM155R71H103KA55#				
	15000pF	±10%	GCM155R71H153KA55#				
22000pF	±10%	GCM155R71H223KA55#					
33000pF	±10%	GCM155R71H333KE02#					
47000pF	±10%	GCM155R71H473KE02#					
68000pF	±10%	GCM155R71H683KE02#					
0.10μF	±10%	GCM155R71H104KE02#					

T max.	Rated Voltage	TC Code	Cap.	Tol.	Part Number	
0.55mm	25Vdc	X8L	0.10μF	±10%	GCM155L81E104KE02#	
			X7R	10000pF	±10%	GCM155R71E103KA37#
				15000pF	±10%	GCM155R71E153KA55#
				22000pF	±10%	GCM155R71E223KA55#
				33000pF	±10%	GCM155R71E333KA55#
	47000pF	±10%		GCM155R71E473KA55#		
	16Vdc	X7R	33000pF	±10%	GCM155R71C333KA37#	
			47000pF	±10%	GCM155R71C473KA37#	
			68000pF	±10%	GCM155R71C683KA55#	
			0.10μF	±10%	GCM155R71C104KA55#	
0.15μF			±10%	GCM155R71C154KE02#		
0.6mm	10Vdc	X7S	0.47μF	±10%	GCM155C71A474KE36#	
			0.68μF	±10%	GCM155C71A684KE38#	
0.7mm	10Vdc	X7S	0.68μF	±10%	GCM155C71A684KE38#	
			1.0μF	±10%	GCM155C71A105KE38#	

1.6×0.8mm

T max.	Rated Voltage	TC Code	Cap.	Tol.	Part Number	
0.9mm	100Vdc	X7R	1000pF	±10%	GCM188R72A102KA37#	
			1500pF	±10%	GCM188R72A152KA37#	
			2200pF	±10%	GCM188R72A222KA37#	
			3300pF	±10%	GCM188R72A332KA37#	
			4700pF	±10%	GCM188R72A472KA37#	
			6800pF	±10%	GCM188R72A682KA37#	
			10000pF	±10%	GCM188R72A103KA37#	
			15000pF	±10%	GCM188R72A153KA37#	
			22000pF	±10%	GCM188R72A223KA37#	
			50Vdc	X7R	0.22μF	±10%
	X7R	0.22μF			±10%	GCM188R71E224KA55#
		0.47μF			±10%	GCM188R71E474KA64#
		1.0μF			±10%	GCM188R71E105KA64#
		X7R		0.33μF	±10%	GCM188R71C334KA37#
	0.47μF			±10%	GCM188R71C474KA55#	
	1.0μF			±10%	GCM188R71C105KA64#	
	6.3Vdc			X7R	2.2μF	±10%

2.0×1.25mm

T max.	Rated Voltage	TC Code	Cap.	Tol.	Part Number
0.7mm	100Vdc	X7R	6800pF	±10%	GCM216R72A682KA37#
			10000pF	±10%	GCM216R72A103KA37#
			15000pF	±10%	GCM216R72A153KA37#
			22000pF	±10%	GCM216R72A223KA37#
0.95mm	100Vdc	X7R	33000pF	±10%	GCM219R72A333KA37#
			50Vdc	X7R	0.33μF
	25Vdc	X7R	0.47μF	±10%	GCM219R71E474KA55#
			16Vdc	X7R	0.68μF
1.0μF	±10%	GCM219R71C105KA37#			
1.4mm	100Vdc	X7R	47000pF	±10%	GCM21BR72A473KA37#
			68000pF	±10%	GCM21BR72A683KA37#
			0.10μF	±10%	GCM21BR72A104KA37#

Part number # indicates the package specification code.

GCM Series High Dielectric Constant Type Part Number List

(→ 2.0×1.25mm)

T max.	Rated Voltage	TC Code	Cap.	Tol.	Part Number
1.4mm	50Vdc	X7R	0.22µF	±10%	GCM21BR71H224KA37#
			0.47µF	±10%	GCM21BR71H474KA55#
			1.0µF	±10%	GCM21BR71H105KA03#
	35Vdc	X8L	2.2µF	±10%	GCM21BL8EG225KE07#
			X7R	0.68µF	±10%
		X7S	1.0µF	±10%	GCM21BR7YA105KA55#
			1.5µF	±10%	GCM21BR7YA155KA54#
			2.2µF	±10%	GCM21BC7YA225KE02#
			25Vdc	X8L	1.5µF
	X7R	0.15µF	±10%	GCM21BR71E154KA37#	
		0.22µF	±10%	GCM21BR71E224KA37#	
		0.33µF	±10%	GCM21BR71E334KA37#	
		0.68µF	±10%	GCM21BR71E684KA55#	
		1.0µF	±10%	GCM21BR71E105KA56#	
		1.5µF	±10%	GCM21BR71E155KA54#	
		2.2µF	±10%	GCM21BR71E225KA73#	
		16Vdc	X7R	2.2µF	±10%
	4.7µF	±10%		GCM21BR71C475KA73#	
	10Vdc	X7R	2.2µF	±10%	GCM21BR71A225KA37#
			10µF	±10%	GCM21BR71A106KE22#
X7S		4.7µF	±10%	GCM21BC71A475KA73#	
6.3Vdc	X7R	10µF	±10%	GCM21BR70J106KE22#	
1.45mm	100Vdc	X7S	1.0µF	±10%	GCM21BC72A105KE36#
	35Vdc	X8L	4.7µF	±10%	GCM21BL8EG475KE08#
		X7S	4.7µF	±10%	GCM21BC7YA475KE36#
	25Vdc	X8L	4.7µF	±10%	GCM21BL8EF475KE08#
		X7S	4.7µF	±10%	GCM21BC71E475KE36#
16Vdc	X7S	10µF	±10%	GCM21BC71C106KE36#	

3.2×2.5mm

T max.	Rated Voltage	TC Code	Cap.	Tol.	Part Number
2.2mm	100Vdc	X8L	4.7µF	±10%	GCM32DL8EL475KE07#
		X7S	4.7µF	±10%	GCM32DC72A475KE02#
	16Vdc	X7R	10µF	±10%	GCM32DR71C106KA37#
2.7mm	50Vdc	X8L	10µF	±10%	GCM32EL8EH106KA07#
		X7R	4.7µF	±10%	GCM32ER71H475KA55#
		X7S	10µF	±10%	GCM32EC71H106KA03#
	35Vdc	X7S	10µF	±10%	GCM32EC7YA106KA03#
	25Vdc	X7R	10µF	±10%	GCM32ER71E106KA57#
	16Vdc	X7R	22µF	±20%	GCM32ER71C226ME19#
	10Vdc	X7R	22µF	±20%	GCM32ER71A226ME12#
2.85mm	25Vdc	X8L	22µF	±10%	GCM32EL8EF226KE08#
		X7S	22µF	±10%	GCM32EC71E226KE36#
	6.3Vdc	X7R	47µF	±20%	GCM32ER70J476ME19#

3.2×1.6mm

T max.	Rated Voltage	TC Code	Cap.	Tol.	Part Number
1.25mm	100Vdc	X7R	0.22µF	±10%	GCM31MR72A224KA37#
	50Vdc	X7R	0.33µF	±10%	GCM31MR71H334KA37#
			0.47µF	±10%	GCM31MR71H474KA37#
			0.68µF	±10%	GCM31MR71H684KA55#
1.8mm	100Vdc	X8L	2.2µF	±10%	GCM31CL8EL225KE07#
		X7R	1.0µF	±10%	GCM31CR72A105KA03#
		X7S	2.2µF	±10%	GCM31CC72A225KE02#
	50Vdc	X7R	2.2µF	±10%	GCM31CR71H225KA55#
		X7S	4.7µF	±10%	GCM31CC71H475KA03#
	25Vdc	X7R	4.7µF	±10%	GCM31CR71E475KA55#
	16Vdc	X7R	4.7µF	±10%	GCM31CR71C475KA37#
			10µF	±10%	GCM31CR71C106KA64#
	10Vdc	X7R	10µF	±10%	GCM31CR71A106KA64#
	22µF		±10%	GCM31CR71A226KE02#	
6.3Vdc	X7R	22µF	±20%	GCM31CR70J226ME23#	
1.9mm	25Vdc	X7S	10µF	±10%	GCM31CC71E106KA03#

Part number # indicates the package specification code.

High Effective Capacitance & High Ripple Current Chip Multilayer Ceramic Capacitors for Automotive

GC3 Series



This is a high ripple resistance product for automotive excellent in DC bias characteristics.

Features

- 1 When a DC bias is applied, a capacitance higher than conventional products (X7R characteristics) can be acquired.

When DC600V is applied, about twice the capacitance can be secured.

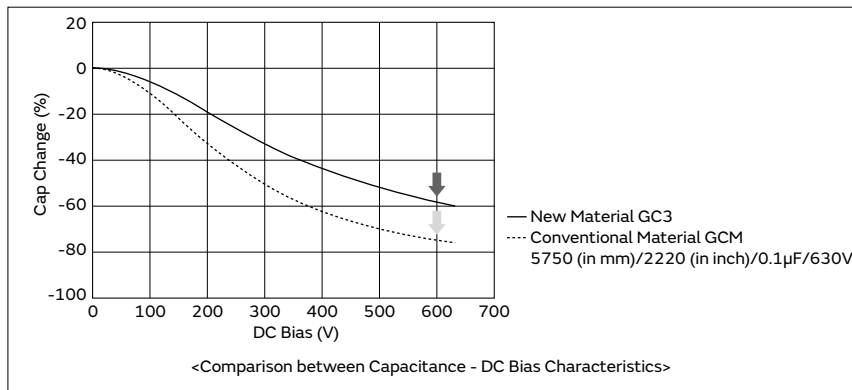

- 2 Improved ripple resistance performance compared to conventional products (X7R characteristics).

In the case of a product with a capacitance of 0.1μF, when the exothermic temperature reaches 20°C at frequency f=300kHz, the amount of resistance of a product with conventional material is 1.8Arms; however, the new material is 2.3Arms.

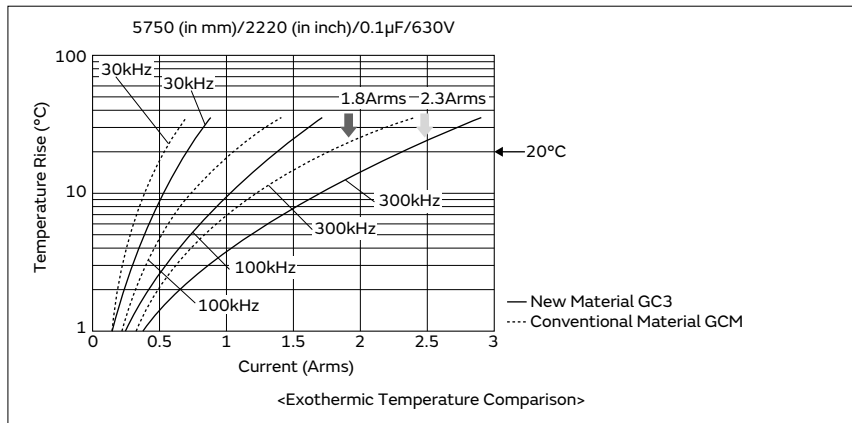

- 3 This product has a noise reduction effect.

Since dielectric materials that enable a reduction of noise are used, this product is more effective for reducing noise compared to the GCM series for automotive.

Specifications

Size	2.0×1.25mm to 5.7×5.0mm
Rated Voltage	250Vdc to 630Vdc
Capacitance	10000pF to 1.0μF
Main Applications	For PFC (Power Factor Correction) Circuits of Power Supplies, EMI Suppression and Smoothing Circuits of automotive



GRT Series
 GCM Series
GC3 Series
 GCJ Series
 GCD Series
 GCE Series
 NMF Series
 KCM Series
 KC3 Series
 KCA Series
 GCG Series
 ⚠Caution / Notice

GC3 Series High Dielectric Constant Type Part Number List

2.0×1.25mm

T max.	Rated Voltage	TC Code	Cap.	Tol.	Part Number
1.0mm	250Vdc	X7T	10000pF	±10%	GC321AD72E103KX01#
			15000pF	±10%	GC321AD72E153KX01#
1.45mm	250Vdc	X7T	22000pF	±10%	GC321BD72E223KX03#

T max.	Rated Voltage	TC Code	Cap.	Tol.	Part Number
2.7mm	250Vdc	X7T	1.0μF	±10%	GC355XD72E105KX05#

3.2×1.6mm

T max.	Rated Voltage	TC Code	Cap.	Tol.	Part Number
1.0mm	450Vdc	X7T	10000pF	±10%	GC331AD72W103KX01#
			15000pF	±10%	GC331AD72W153KX01#
	250Vdc	X7T	33000pF	±10%	GC331AD72E333KX01#
1.25mm	630Vdc	X7T	10000pF	±10%	GC331BD72J103KX01#
	450Vdc	X7T	22000pF	±10%	GC331BD72W223KX01#
			33000pF	±10%	GC331BD72W333KX01#
	250Vdc	X7T	47000pF	±10%	GC331BD72E473KX01#
1.8mm	630Vdc	X7T	15000pF	±10%	GC331CD72J153KX03#
	450Vdc	X7T	47000pF	±10%	GC331CD72W473KX03#
	250Vdc	X7T	68000pF	±10%	GC331CD72E683KX03#

3.2×2.5mm

T max.	Rated Voltage	TC Code	Cap.	Tol.	Part Number
1.5mm	630Vdc	X7T	22000pF	±10%	GC332QD72J223KX01#
	250Vdc	X7T	0.10μF	±10%	GC332QD72E104KX01#
2.0mm	630Vdc	X7T	33000pF	±10%	GC332DD72J333KX01#
			47000pF	±10%	GC332DD72J473KX01#
	450Vdc	X7T	68000pF	±10%	GC332DD72W683KX01#
			0.10μF	±10%	GC332DD72W104KX01#
	250Vdc	X7T	0.15μF	±10%	GC332DD72E154KX01#

4.5×3.2mm

T max.	Rated Voltage	TC Code	Cap.	Tol.	Part Number
1.5mm	250Vdc	X7T	0.22μF	±10%	GC343QD72E224KX01#
2.0mm	630Vdc	X7T	68000pF	±10%	GC343DD72J683KX01#
	450Vdc	X7T	0.15μF	±10%	GC343DD72W154KX01#
	250Vdc	X7T	0.33μF	±10%	GC343DD72E334KX01#

5.7×5.0mm

T max.	Rated Voltage	TC Code	Cap.	Tol.	Part Number
2.0mm	630Vdc	X7T	0.10μF	±10%	GC355DD72J104KX01#
			0.15μF	±10%	GC355DD72J154KX01#
	450Vdc	X7T	0.22μF	±10%	GC355DD72W224KX01#
			0.33μF	±10%	GC355DD72W334KX01#
			0.47μF	±10%	GC355DD72W474KX01#
	250Vdc	X7T	0.47μF	±10%	GC355DD72E474KX01#
0.68μF			±10%	GC355DD72E684KX01#	
2.7mm	630Vdc	X7T	0.22μF	±10%	GC355XD72J224KX05#

Part number # indicates the package specification code.

GRT Series
 GCM Series
 GC3 Series
 GCJ Series
 GCD Series
 GCE Series
 NMF Series
 KCM Series
 KC3 Series
 KCA Series
 GCG Series
 ⚠Caution/Notice

Soft Termination Chip Multilayer Ceramic Capacitors for Automotive

GCJ Series



Cracking caused by flexing stress after board mounting is minimized due to resin external electrodes!

Features

① The resin external electrodes suppress cracks by board deflection.

Cracking of the ceramic element is suppressed by the resin of the external electrodes, which releases the stress.

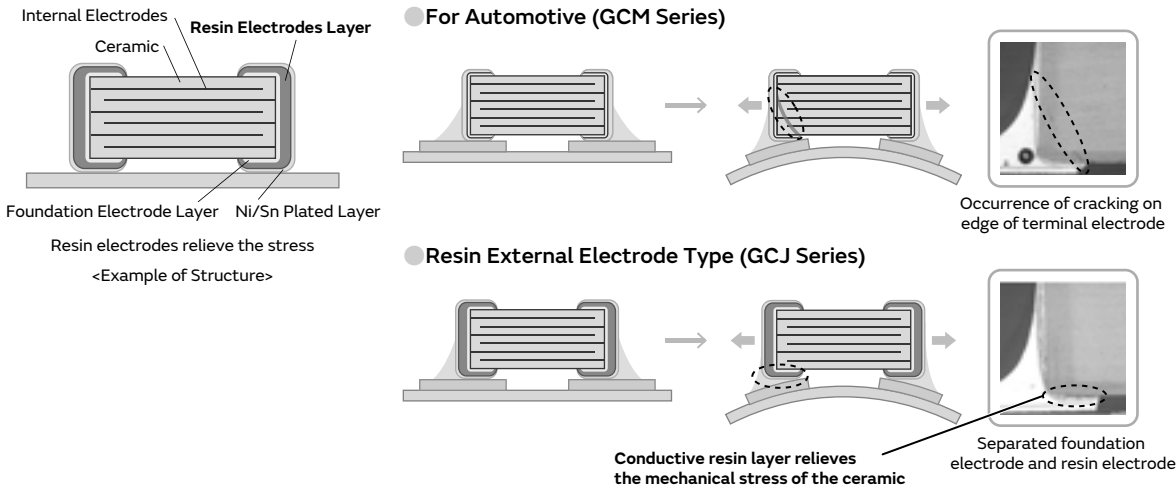

Note: Cracks may occur in the capacitor body if excessive stress beyond the "guaranteed range of board bending strength (*)" provided in the specifications is applied. Capacitors with cracks in them may cause a drop in insulation resistance, which could lead to a short circuit.
 (*) For details on the guaranteed range of board bending strength, check the "Detailed Specification Sheet" on the Product Details Page.

② Suppresses the occurrence of cracking caused by deflection stress at the time of board mounting, etc.

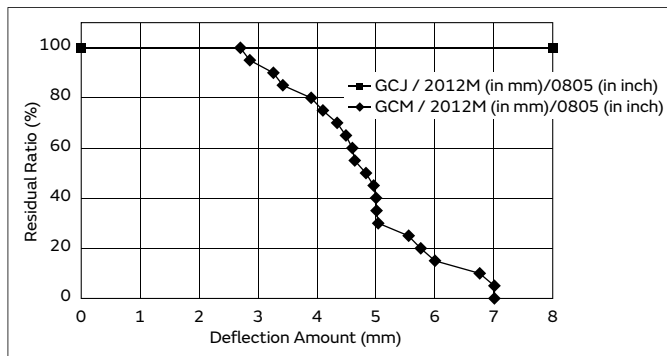

Due to the specification of the measuring instrument, measurements can be performed up to 8mm.

③ Ideal for automotive.

This AEC-Q200 conforming product is ideal for the ECU, control circuits of headlights, etc. of automotive.

Specifications

Size	1.6×0.8mm to 5.7×5.0mm
Rated Voltage	6.3Vdc to 1000Vdc
Capacitance	220pF to 47μF
Main Applications	Battery Lines and Powertrains for automotive

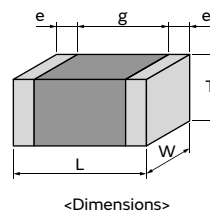

GRT Series
 GCM Series
 GC3 Series
 GCJ Series
 GCD Series
 GCE Series
 NMF Series
 KCM Series
 KC3 Series
 KCA Series
 GCG Series
 ⚠Caution / Notice

GCJ Series High Dielectric Constant Type **Power-train** **AEC-Q200** **Fail safe** **Deflecting crack** Part Number List

1.6×0.8mm

T max.	Rated Voltage	TC Code	Cap.	Tol.	Part Number	
0.9mm	100Vdc	X8L	0.10μF	±10%	GCJ188L8EL104KA07#	
			X8R	1000pF	±10%	GCJ188R92A102KA01#
				1200pF	±10%	GCJ188R92A122KA01#
				1500pF	±10%	GCJ188R92A152KA01#
				1800pF	±10%	GCJ188R92A182KA01#
				2200pF	±10%	GCJ188R92A222KA01#
				2700pF	±10%	GCJ188R92A272KA01#
				3300pF	±10%	GCJ188R92A332KA01#
				3900pF	±10%	GCJ188R92A392KA01#
				4700pF	±10%	GCJ188R92A472KA01#
				5600pF	±10%	GCJ188R92A562KA01#
				6800pF	±10%	GCJ188R92A682KA01#
		8200pF		±10%	GCJ188R92A822KA01#	
		X7R	1000pF	±10%	GCJ188R72A102KA01#	
			1200pF	±10%	GCJ188R72A122KA01#	
			1500pF	±10%	GCJ188R72A152KA01#	
			1800pF	±10%	GCJ188R72A182KA01#	
			2200pF	±10%	GCJ188R72A222KA01#	
			2700pF	±10%	GCJ188R72A272KA01#	
			3300pF	±10%	GCJ188R72A332KA01#	
			3900pF	±10%	GCJ188R72A392KA01#	
			4700pF	±10%	GCJ188R72A472KA01#	
			5600pF	±10%	GCJ188R72A562KA01#	
			6800pF	±10%	GCJ188R72A682KA01#	
			8200pF	±10%	GCJ188R72A822KA01#	
		X8L	1000pF	±10%	GCJ188L81H102KA01#	
			1200pF	±10%	GCJ188L81H122KA01#	
			1500pF	±10%	GCJ188L81H152KA01#	
			1800pF	±10%	GCJ188L81H182KA01#	
			2200pF	±10%	GCJ188L81H222KA01#	
			2700pF	±10%	GCJ188L81H272KA01#	
			3300pF	±10%	GCJ188L81H332KA01#	
			3900pF	±10%	GCJ188L81H392KA01#	
			4700pF	±10%	GCJ188L81H472KA01#	
			5600pF	±10%	GCJ188L81H562KA01#	
			0.10μF	±10%	GCJ188R72A104KA01#	
			X8L	1000pF	±10%	GCJ188L81H102KA01#
		1200pF		±10%	GCJ188L81H122KA01#	
		1500pF		±10%	GCJ188L81H152KA01#	
		1800pF		±10%	GCJ188L81H182KA01#	
		2200pF		±10%	GCJ188L81H222KA01#	
		2700pF		±10%	GCJ188L81H272KA01#	
		3300pF		±10%	GCJ188L81H332KA01#	
		3900pF		±10%	GCJ188L81H392KA01#	
		4700pF		±10%	GCJ188L81H472KA01#	
		5600pF		±10%	GCJ188L81H562KA01#	
		0.10μF		±10%	GCJ188R72A104KA01#	

T max.	Rated Voltage	TC Code	Cap.	Tol.	Part Number	
0.9mm	50Vdc	X8L	6800pF	±10%	GCJ188L81H682KA01#	
			8200pF	±10%	GCJ188L81H822KA01#	
			10000pF	±10%	GCJ188L81H103KA01#	
			12000pF	±10%	GCJ188L81H123KA01#	
			15000pF	±10%	GCJ188L81H153KA01#	
			18000pF	±10%	GCJ188L81H183KA01#	
			22000pF	±10%	GCJ188L81H223KA01#	
			0.15μF	±10%	GCJ188L8EH154KA07#	
			0.22μF	±10%	GCJ188L8EH224KA07#	
			X8R	4700pF	±10%	GCJ188R91H472KA01#
				10000pF	±10%	GCJ188R91H103KA01#
				0.10μF	±10%	GCJ188R91H104KA01#
		0.12μF		±10%	GCJ188R91H124KA01#	
		0.15μF		±10%	GCJ188R91H154KA01#	
		0.18μF		±10%	GCJ188R91H184KA01#	
		0.22μF		±10%	GCJ188R91H224KA01#	
		X7R		1000pF	±10%	GCJ188R71H102KA01#
				1200pF	±10%	GCJ188R71H122KA01#
				1500pF	±10%	GCJ188R71H152KA01#
				1800pF	±10%	GCJ188R71H182KA01#
				2200pF	±10%	GCJ188R71H222KA01#
			2700pF	±10%	GCJ188R71H272KA01#	
			3300pF	±10%	GCJ188R71H332KA01#	
			3900pF	±10%	GCJ188R71H392KA01#	
			4700pF	±10%	GCJ188R71H472KA01#	
			5600pF	±10%	GCJ188R71H562KA01#	
			6800pF	±10%	GCJ188R71H682KA01#	
			8200pF	±10%	GCJ188R71H822KA01#	
		X8L	33000pF	±10%	GCJ188L8YA333KA01#	
			39000pF	±10%	GCJ188L8YA393KA01#	
			56000pF	±10%	GCJ188L8YA563KA01#	
			68000pF	±10%	GCJ188L8YA683KA01#	
			X8L	33000pF	±10%	GCJ188L81E333KA01#
				39000pF	±10%	GCJ188L81E393KA01#
				56000pF	±10%	GCJ188L81E563KA01#
				68000pF	±10%	GCJ188L81E683KA01#
				82000pF	±10%	GCJ188L81E823KA01#
				0.15μF	±10%	GCJ188L81E154KA01#
				0.18μF	±10%	GCJ188L81E184KA01#
				0.22μF	±10%	GCJ188L81E224KA01#

Part number # indicates the package specification code.

GRT Series
 GCM Series
 GC3 Series
 GCJ Series
 GCD Series
 GCE Series
 NMF Series
 KCM Series
 KC3 Series
 KCA Series
 GCG Series
 Caution/ Notice

GCJ Series High Dielectric Constant Type Part Number List

(→ 1.6×0.8mm)

T max.	Rated Voltage	TC Code	Cap.	Tol.	Part Number		
0.9mm	25Vdc	X8R	0.33μF	±10%	GCJ188R91E334KA01#		
			0.39μF	±10%	GCJ188R91E394KA01#		
			0.47μF	±10%	GCJ188R91E474KA01#		
		16Vdc	X8L	X7R	1000pF	±10%	GCJ188R71E102KA01#
					1200pF	±10%	GCJ188R71E122KA01#
					1500pF	±10%	GCJ188R71E152KA01#
				1800pF	±10%	GCJ188R71E182KA01#	
				2200pF	±10%	GCJ188R71E222KA01#	
				2700pF	±10%	GCJ188R71E272KA01#	
				3300pF	±10%	GCJ188R71E332KA01#	
				3900pF	±10%	GCJ188R71E392KA01#	
				4700pF	±10%	GCJ188R71E472KA01#	
				5600pF	±10%	GCJ188R71E562KA01#	
				6800pF	±10%	GCJ188R71E682KA01#	
				8200pF	±10%	GCJ188R71E822KA01#	
				10000pF	±10%	GCJ188R71E103KA01#	
				12000pF	±10%	GCJ188R71E123KA01#	
				15000pF	±10%	GCJ188R71E153KA01#	
				18000pF	±10%	GCJ188R71E183KA01#	
				22000pF	±10%	GCJ188R71E223KA01#	
				27000pF	±10%	GCJ188R71E273KA01#	
				33000pF	±10%	GCJ188R71E333KA01#	
				39000pF	±10%	GCJ188R71E393KA01#	
				47000pF	±10%	GCJ188R71E473KA01#	
				56000pF	±10%	GCJ188R71E563KA12#	
				68000pF	±10%	GCJ188R71E683KA12#	
				82000pF	±10%	GCJ188R71E823KA12#	
	0.10μF			±10%	GCJ188R71E104KA12#		
	0.12μF			±10%	GCJ188R71E124KA01#		
	0.15μF			±10%	GCJ188R71E154KA01#		
	0.18μF	±10%	GCJ188R71E184KA12#				
	0.22μF	±10%	GCJ188R71E224KA12#				
	1.0μF	±10%	GCJ188R71E105KA01#				
	16Vdc	X8L	X7R	33000pF	±10%	GCJ188L81C333KA01#	
				39000pF	±10%	GCJ188L81C393KA01#	
				47000pF	±10%	GCJ188L81C473KA01#	
			56000pF	±10%	GCJ188L81C563KA01#		
			68000pF	±10%	GCJ188L81C683KA01#		
			82000pF	±10%	GCJ188L81C823KA01#		
			0.10μF	±10%	GCJ188L81C104KA01#		
			0.12μF	±10%	GCJ188L81C124KA01#		
			0.15μF	±10%	GCJ188L81C154KA01#		
			0.18μF	±10%	GCJ188L81C184KA01#		
			0.22μF	±10%	GCJ188L81C224KA01#		
			X7R	X7R	10000pF	±10%	GCJ188R71C103KA01#
27000pF					±10%	GCJ188R71C273KA01#	
33000pF					±10%	GCJ188R71C333KA01#	
39000pF				±10%	GCJ188R71C393KA01#		
47000pF		±10%		GCJ188R71C473KA01#			
56000pF		±10%		GCJ188R71C563KA01#			
68000pF		±10%		GCJ188R71C683KA01#			
82000pF		±10%		GCJ188R71C823KA01#			
0.10μF		±10%		GCJ188R71C104KA01#			
0.12μF		±10%		GCJ188R71C124KA01#			

T max.	Rated Voltage	TC Code	Cap.	Tol.	Part Number			
0.9mm	16Vdc	X7R	0.15μF	±10%	GCJ188R71C154KA01#			
			0.18μF	±10%	GCJ188R71C184KA01#			
			0.22μF	±10%	GCJ188R71C224KA01#			
			0.27μF	±10%	GCJ188R71C274KA01#			
			0.33μF	±10%	GCJ188R71C334KA01#			
			0.39μF	±10%	GCJ188R71C394KA12#			
			0.47μF	±10%	GCJ188R71C474KA12#			
			10Vdc	X7R	0.12μF	±10%	GCJ188R71A124KA01#	
					0.15μF	±10%	GCJ188R71A154KA01#	
					0.18μF	±10%	GCJ188R71A184KA01#	
					0.22μF	±10%	GCJ188R71A224KA01#	
					2.2μF	±10%	GCJ188R70J225KE01#	
					3.3μF	±10%	GCJ188L8EC335KE08#	
			1.0mm	6.3Vdc	X8L	4.7μF	±10%	GCJ188M8EC475KE08#
						3.3μF	±10%	GCJ188C70J335KE02#
X7S	4.7μF	±10%			GCJ188C70J475KE02#			

2.0×1.25mm

T max.	Rated Voltage	TC Code	Cap.	Tol.	Part Number		
0.7mm	100Vdc	X7R	1000pF	±10%	GCJ216R72A102KA01#		
			1200pF	±10%	GCJ216R72A122KA01#		
			1500pF	±10%	GCJ216R72A152KA01#		
			1800pF	±10%	GCJ216R72A182KA01#		
			2200pF	±10%	GCJ216R72A222KA01#		
			2700pF	±10%	GCJ216R72A272KA01#		
			3300pF	±10%	GCJ216R72A332KA01#		
			3900pF	±10%	GCJ216R72A392KA01#		
			4700pF	±10%	GCJ216R72A472KA01#		
			5600pF	±10%	GCJ216R72A562KA01#		
			6800pF	±10%	GCJ216R72A682KA01#		
			8200pF	±10%	GCJ216R72A822KA01#		
			10000pF	±10%	GCJ216R72A103KA01#		
			12000pF	±10%	GCJ216R72A123KA01#		
			15000pF	±10%	GCJ216R72A153KA01#		
			18000pF	±10%	GCJ216R72A183KA01#		
			22000pF	±10%	GCJ216R72A223KA01#		
			50Vdc	X7R	330pF	±10%	GCJ216R71H331KA01#
					390pF	±10%	GCJ216R71H391KA01#
					470pF	±10%	GCJ216R71H471KA01#
					560pF	±10%	GCJ216R71H561KA01#
					680pF	±10%	GCJ216R71H681KA01#
					820pF	±10%	GCJ216R71H821KA01#
					470pF	±10%	GCJ216R71E471KA01#
					560pF	±10%	GCJ216R71E561KA01#
					680pF	±10%	GCJ216R71E681KA01#
					820pF	±10%	GCJ216R71E821KA01#
25Vdc	X7R	220pF	±10%	GCJ219R72A221KA01#			
		270pF	±10%	GCJ219R72A271KA01#			
		330pF	±10%	GCJ219R72A331KA01#			
		390pF	±10%	GCJ219R72A391KA01#			
		470pF	±10%	GCJ219R72A471KA01#			
		560pF	±10%	GCJ219R72A561KA01#			

Part number # indicates the package specification code.

GRT Series
 GCM Series
 GC3 Series
 GCJ Series
 GCD Series
 GCE Series
 NMF Series
 KCM Series
 KC3 Series
 KCA Series
 GCG Series
 ⚠Caution / Notice

GCJ Series High Dielectric Constant Type **Power-train** **AEC-Q200** **Fail safe** **Deflecting crack** Part Number List

(→ 2.0×1.25mm)

T max.	Rated Voltage	TC Code	Cap.	Tol.	Part Number	
0.95mm	100Vdc	X7R	680pF	±10%	GCJ219R72A681KA01#	
			820pF	±10%	GCJ219R72A821KA01#	
			27000pF	±10%	GCJ219R72A273KA01#	
			33000pF	±10%	GCJ219R72A333KA01#	
			39000pF	±10%	GCJ219R72A393KA01#	
	50Vdc	X7R	27000pF	±10%	GCJ219R71H273KA01#	
			33000pF	±10%	GCJ219R71H333KA01#	
			39000pF	±10%	GCJ219R71H393KA01#	
			0.33μF	±10%	GCJ219R71H334KA12#	
	25Vdc	X7R	0.33μF	±10%	GCJ219R71E334KA01#	
			0.47μF	±10%	GCJ219R71E474KA12#	
	16Vdc	X7R	0.68μF	±10%	GCJ219R71C684KA01#	
			0.82μF	±10%	GCJ219R71C824KA01#	
			1.0μF	±10%	GCJ219R71C105KA01#	
	1.0mm	250Vdc	X7R	1000pF	±10%	GCJ21AR72E102KXJ1#
				1500pF	±10%	GCJ21AR72E152KXJ1#
				2200pF	±10%	GCJ21AR72E222KXJ1#
				3300pF	±10%	GCJ21AR72E332KXJ1#
				4700pF	±10%	GCJ21AR72E472KXJ1#
				6800pF	±10%	GCJ21AR72E682KXJ1#
10000pF				±10%	GCJ21AR72E103KXJ3#	
1.45mm	250Vdc	X7R	15000pF	±10%	GCJ21BR72E153KXJ3#	
			22000pF	±10%	GCJ21BR72E223KXJ3#	
			47000pF	±10%	GCJ21BR72A473KA01#	
	100Vdc	X7R	56000pF	±10%	GCJ21BR72A563KA01#	
			68000pF	±10%	GCJ21BR72A683KA01#	
			82000pF	±10%	GCJ21BR72A823KA01#	
			0.10μF	±10%	GCJ21BR72A104KA01#	
			27000pF	±10%	GCJ21BL81H273KA01#	
	50Vdc	X8L	33000pF	±10%	GCJ21BL81H333KA01#	
			39000pF	±10%	GCJ21BL81H393KA01#	
			47000pF	±10%	GCJ21BL81H473KA01#	
			56000pF	±10%	GCJ21BL81H563KA01#	
			68000pF	±10%	GCJ21BL81H683KA01#	
			82000pF	±10%	GCJ21BL81H823KA01#	
			0.10μF	±10%	GCJ21BL81H104KA01#	
			47000pF	±10%	GCJ21BR71H473KA01#	
			56000pF	±10%	GCJ21BR71H563KA01#	
			68000pF	±10%	GCJ21BR71H683KA01#	
	35Vdc	X8L	82000pF	±10%	GCJ21BR71H823KA01#	
			0.10μF	±10%	GCJ21BR71H104KA01#	
0.12μF			±10%	GCJ21BR71H124KA01#		
0.15μF			±10%	GCJ21BR71H154KA01#		
0.18μF			±10%	GCJ21BR71H184KA01#		
0.22μF			±10%	GCJ21BR71H224KA01#		
0.47μF			±10%	GCJ21BR71H474KA12#		
1.0μF			±10%	GCJ21BR71H105KA01#		
0.12μF			±10%	GCJ21BL8YA124KA01#		
0.15μF			±10%	GCJ21BL8YA154KA01#		
25Vdc	X8L	0.18μF	±10%	GCJ21BL8YA184KA01#		
		0.22μF	±10%	GCJ21BL8YA224KA01#		
		0.33μF	±10%	GCJ21BL8YA334KA01#		
		0.47μF	±10%	GCJ21BL8YA474KA01#		
		0.12μF	±10%	GCJ21BL81E124KA01#		

T max.	Rated Voltage	TC Code	Cap.	Tol.	Part Number		
1.45mm	25Vdc	X8L	0.15μF	±10%	GCJ21BL81E154KA01#		
			0.18μF	±10%	GCJ21BL81E184KA01#		
			0.22μF	±10%	GCJ21BL81E224KA01#		
			0.27μF	±10%	GCJ21BL81E274KA01#		
			0.33μF	±10%	GCJ21BL81E334KA01#		
			0.39μF	±10%	GCJ21BL81E394KA01#		
			0.47μF	±10%	GCJ21BL81E474KA01#		
			0.68μF	±10%	GCJ21BL81E684KA01#		
			0.82μF	±10%	GCJ21BL81E824KA01#		
			1.0μF	±10%	GCJ21BL81E105KA01#		
			16Vdc	X8L	27000pF	±10%	GCJ21BR71E273KA01#
					56000pF	±10%	GCJ21BR71E563KA01#
					68000pF	±10%	GCJ21BR71E683KA01#
					82000pF	±10%	GCJ21BR71E823KA01#
					0.10μF	±10%	GCJ21BR71E104KA01#
	0.27μF	±10%			GCJ21BR71E274KA01#		
	0.39μF	±10%			GCJ21BR71E394KA01#		
	0.56μF	±10%			GCJ21BR71E564KA12#		
	0.68μF	±10%			GCJ21BR71E684KA12#		
	0.82μF	±10%			GCJ21BR71E824KA12#		
	10Vdc	X7R	1.0μF	±10%	GCJ21BR71E105KA12#		
			1.5μF	±10%	GCJ21BR71E155KA01#		
			2.2μF	±10%	GCJ21BR71E225KA01#		
			0.56μF	±10%	GCJ21BL81C564KA01#		
			0.68μF	±10%	GCJ21BL81C684KA01#		
			0.82μF	±10%	GCJ21BL81C824KA01#		
			1.0μF	±10%	GCJ21BL81C105KA01#		
			0.27μF	±10%	GCJ21BR71C274KA01#		
			0.33μF	±10%	GCJ21BR71C334KA01#		
			0.39μF	±10%	GCJ21BR71C394KA01#		
	1.5mm	100Vdc	X7S	1.0μF	±10%	GCJ21BC72A105KE02#	
				2.2μF	±10%	GCJ21BR71A225KA01#	
				10μF	±10%	GCJ21BR71A106KE01#	
				0.27μF	±10%	GCJ21BR71C274KA01#	
				0.33μF	±10%	GCJ21BR71C334KA01#	

3.2×1.6mm

T max.	Rated Voltage	TC Code	Cap.	Tol.	Part Number
0.95mm	100Vdc	X7R	0.10μF	±10%	GCJ319R72A104KA01#
1.25mm	1000Vdc	X7R	1000pF	±10%	GCJ31BR73A102KXJ1#
			1500pF	±10%	GCJ31BR73A152KXJ1#
			2200pF	±10%	GCJ31BR73A222KXJ1#
			3300pF	±10%	GCJ31BR73A332KXJ1#
			4700pF	±10%	GCJ31BR73A472KXJ1#
	630Vdc	X7R	1000pF	±10%	GCJ31BR72J102KXJ1#
			1500pF	±10%	GCJ31BR72J152KXJ1#
			2200pF	±10%	GCJ31BR72J222KXJ1#
			3300pF	±10%	GCJ31BR72J332KXJ1#
			4700pF	±10%	GCJ31BR72J472KXJ1#

Part number # indicates the package specification code.

GRT Series
 GCM Series
 GC3 Series
 GCJ Series
 GCD Series
 GCE Series
 NMF Series
 KCM Series
 KC3 Series
 KCA Series
 GCG Series
 Caution/Notice

GCJ Series High Dielectric Constant Type Part Number List

(→ 3.2×1.6mm)

T max.	Rated Voltage	TC Code	Cap.	Tol.	Part Number	
1.25mm	630Vdc	X7R	6800pF	±10%	GCJ31BR72J682KXJ1#	
			10000pF	±10%	GCJ31BR72J103KXJ1#	
	250Vdc	X7R	15000pF	±10%	GCJ31BR72E153KXJ1#	
			22000pF	±10%	GCJ31BR72E223KXJ1#	
			68000pF	±10%	GCJ31BR72E683KXJ1#	
1.35mm	100Vdc	X7R	0.15μF	±10%	GCJ31MR72A154KA01#	
			0.18μF	±10%	GCJ31MR72A184KA01#	
			0.22μF	±10%	GCJ31MR72A224KA01#	
	50Vdc	X7R	0.27μF	±10%	GCJ31MR71H274KA01#	
			0.39μF	±10%	GCJ31MR71H394KA01#	
			0.47μF	±10%	GCJ31MR71H474KA01#	
			0.56μF	±10%	GCJ31MR71H564KA12#	
			0.68μF	±10%	GCJ31MR71H684KA12#	
			0.82μF	±10%	GCJ31MR71H824KA12#	
			1.0μF	±10%	GCJ31MR71H105KA12#	
	25Vdc	X7R	0.12μF	±10%	GCJ31MR71E124KA01#	
			0.15μF	±10%	GCJ31MR71E154KA01#	
			0.18μF	±10%	GCJ31MR71E184KA01#	
			0.22μF	±10%	GCJ31MR71E224KA01#	
			1.5μF	±10%	GCJ31MR71E155KA12#	
			2.2μF	±10%	GCJ31MR71E225KA12#	
			3.3μF	±10%	GCJ31MR71E335KA12#	
	16Vdc	X7R	1.5μF	±10%	GCJ31MR71C155KA01#	
	1.8mm	1000Vdc	X7R	6800pF	±10%	GCJ31CR73A682KXJ3#
				10000pF	±10%	GCJ31CR73A103KXJ3#
630Vdc		X7R	15000pF	±10%	GCJ31CR72J153KXJ3#	
			22000pF	±10%	GCJ31CR72J223KXJ3#	
			33000pF	±10%	GCJ31CR72E333KXJ3#	
250Vdc		X7R	47000pF	±10%	GCJ31CR72E473KXJ3#	
			0.10μF	±10%	GCJ31CR72E104KXJ3#	
1.9mm	100Vdc	X8L	1.0μF	±10%	GCJ31CL8EL105KA07#	
		X7R	1.0μF	±10%	GCJ31CR72A105KA01#	
	50Vdc	X7R	1.5μF	±10%	GCJ31CR71H155KA12#	
			2.2μF	±10%	GCJ31CR71H225KA12#	
			4.7μF	±10%	GCJ31CC71H475KA01#	
	35Vdc	X8L	0.56μF	±10%	GCJ31CL8YA564KA01#	
			0.68μF	±10%	GCJ31CL8YA684KA01#	
			0.82μF	±10%	GCJ31CL8YA824KA01#	
			1.0μF	±10%	GCJ31CL8YA105KA01#	
	25Vdc	X8L	0.56μF	±10%	GCJ31CL81E564KA01#	
			0.68μF	±10%	GCJ31CL81E684KA01#	
			0.82μF	±10%	GCJ31CL81E824KA01#	
		X7R	4.7μF	±10%	GCJ31CR71E475KA12#	
		16Vdc	X8L	3.3μF	±10%	GCJ31CL81C335KA01#
	4.7μF			±10%	GCJ31CL81C475KA01#	
	X7R		3.3μF	±10%	GCJ31CR71C335KA01#	
			X7R	4.7μF	±10%	GCJ31CR71C475KA01#
			X7R	10μF	±10%	GCJ31CR71C106KA15#
	10Vdc	X8L	22μF	±10%	GCJ31CL8ED226KE07#	
			X7R	6.8μF	±10%	GCJ31CR71A685KA13#
			10μF	±10%	GCJ31CR71A106KA13#	
			22μF	±10%	GCJ31CR71A226KE01#	
6.3Vdc	X7R	22μF	±10%	GCJ31CR70J226KE01#		
2.0mm	25Vdc	X8L	10μF	±10%	GCJ31CL8EF106KA08#	

T max.	Rated Voltage	TC Code	Cap.	Tol.	Part Number
2.0mm	25Vdc	X7S	10μF	±10%	GCJ31CC71E106KA15#

3.2×2.5mm

T max.	Rated Voltage	TC Code	Cap.	Tol.	Part Number		
1.5mm	630Vdc	X7R	6800pF	±10%	GCJ32QR72J682KXJ1#		
			10000pF	±10%	GCJ32QR72J103KXJ1#		
	250Vdc	X7R	68000pF	±10%	GCJ32QR72E683KXJ1#		
			0.15μF	±10%	GCJ32QR72E154KXJ1#		
2.0mm	1000Vdc	X7R	15000pF	±10%	GCJ32DR73A153KXJ1#		
			22000pF	±10%	GCJ32DR73A223KXJ1#		
			630Vdc	X7R	15000pF	±10%	GCJ32DR72J153KXJ1#
					22000pF	±10%	GCJ32DR72J223KXJ1#
			X7R	33000pF	±10%	GCJ32DR72J333KXJ1#	
			X7R	47000pF	±10%	GCJ32DR72J473KXJ1#	
	250Vdc	X7R	0.10μF	±10%	GCJ32DR72E104KXJ1#		
			0.22μF	±10%	GCJ32DR72E224KXJ1#		
	2.3mm	100Vdc	X8L	2.2μF	±10%	GCJ32DL8EL225KA07#	
			X7R	2.2μF	±10%	GCJ32DR72A225KA01#	
X7S			4.7μF	±10%	GCJ32DC72A475KE01#		
2.8mm	50Vdc	X7R	4.7μF	±10%	GCJ32ER71H475KA12#		
			X7S	10μF	±10%	GCJ32EC71H106KA01#	
	25Vdc	X8L	4.7μF	±10%	GCJ32EL81E475KA01#		
			6.8μF	±10%	GCJ32ER91C685KE01#		
	16Vdc	X8R	10μF	±10%	GCJ32ER91C106KE01#		
			X7R	22μF	±10%	GCJ32ER71C226KE01#	
6.3Vdc	X7R	47μF	±10%	GCJ32ER70J476KE01#			
2.85mm	25Vdc	X8L	22μF	±10%	GCJ32EL8EF226KE08#		
		X7S	22μF	±10%	GCJ32EC71E226KE02#		

4.5×3.2mm

T max.	Rated Voltage	TC Code	Cap.	Tol.	Part Number
1.5mm	630Vdc	X7R	68000pF	±10%	GCJ43QR72J683KXJ1#
	250Vdc	X7R	0.15μF	±10%	GCJ43QR72E154KXJ1#
2.0mm	1000Vdc	X7R	33000pF	±10%	GCJ43DR73A333KXJ1#
			47000pF	±10%	GCJ43DR73A473KXJ1#
	630Vdc	X7R	33000pF	±10%	GCJ43DR72J333KXJ1#
			47000pF	±10%	GCJ43DR72J473KXJ1#
			0.10μF	±10%	GCJ43DR72J104KXJ1#
			0.22μF	±10%	GCJ43DR72E224KXJ1#
250Vdc	X7R	0.33μF	±10%	GCJ43DR72E334KXJ1#	
		0.47μF	±10%	GCJ43DR72E474KXJ1#	

5.7×5.0mm

T max.	Rated Voltage	TC Code	Cap.	Tol.	Part Number
2.0mm	1000Vdc	X7R	68000pF	±10%	GCJ55DR73A683KXJ1#
			0.10μF	±10%	GCJ55DR73A104KXJ1#
	630Vdc	X7R	0.10μF	±10%	GCJ55DR72J104KXJ1#
			0.15μF	±10%	GCJ55DR72J154KXJ1#

Part number # indicates the package specification code.

GRT Series

GCM Series

GC3 Series

GCJ Series

GCD Series

GCE Series

NMF Series

KCM Series

KC3 Series

KCA Series

GCG Series

⚠Caution/
 Notice

GCJ Series High Dielectric Constant Type Part Number List

(→ 5.7×5.0mm)

T max.	Rated Voltage	TC Code	Cap.	Tol.	Part Number
2.0mm	630Vdc	X7R	0.22μF	±10%	GCJ55DR72J224KXJ1#
			0.33μF	±10%	GCJ55DR72E334KXJ1#
	250Vdc	X7R	0.47μF	±10%	GCJ55DR72E474KXJ1#
			0.68μF	±10%	GCJ55DR72E684KXJ1#
			1.0μF	±10%	GCJ55DR72E105KXJ1#

MLSC Design Chip Multilayer Ceramic Capacitors for Automotive

GCD Series



Prevents momentary dielectric breakdown by a 2-element array structure!

Features

1 Prevents momentary dielectric breakdown by a 2-element array structure!

This product consists of 2 elements arranged in 1 capacitor. It is structured so that even when 1 element is shorted, the other capacitor element will not short.

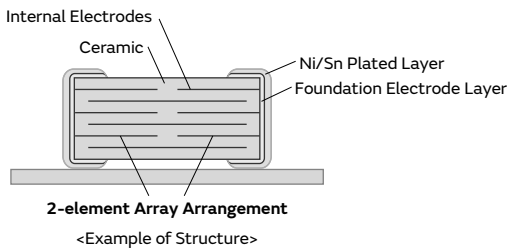

2 This AEC-Q200 conforming product is ideal for the battery lines of automotive.

Space can be reduced in battery lines where 2 capacitors are arranged in an array.

Specifications

Size	1.6×0.8mm to 2.0×1.25mm
Rated Voltage	16Vdc to 100Vdc
Capacitance	1000pF to 0.50μF
Main Applications	Battery Lines and Powertrains for automotive

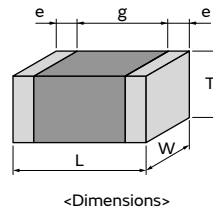

GRT Series

GCM Series

GC3 Series

GCJ Series

GCD Series

GCE Series

NMF Series

KCM Series

KC3 Series

KCA Series

GCG Series

⚠Caution /Notice

45

GRT Series

GCM Series

GC3 Series

G CJ Series

GCD Series

GCE Series

NMF Series

KCM Series

KC3 Series

KCA Series

GCG Series

⚠Caution/
 Notice

GCD Series High Dielectric Constant Type Power-train AEC-Q200 Fail safe Deflecting crack Part Number List

1.6×0.8mm

T max.	Rated Voltage	TC Code	Cap.	Tol.	Part Number		
0.9mm	100Vdc	X7R	1000pF	±10%	GCD188R72A102KA01#		
			1200pF	±10%	GCD188R72A122KA01#		
			1500pF	±10%	GCD188R72A152KA01#		
			1800pF	±10%	GCD188R72A182KA01#		
			2200pF	±10%	GCD188R72A222KA01#		
			2700pF	±10%	GCD188R72A272KA01#		
			3300pF	±10%	GCD188R72A332KA01#		
			3900pF	±10%	GCD188R72A392KA01#		
			4700pF	±10%	GCD188R72A472KA01#		
			5600pF	±10%	GCD188R72A562KA01#		
			6800pF	±10%	GCD188R72A682KA01#		
			8200pF	±10%	GCD188R72A822KA01#		
			10000pF	±10%	GCD188R72A103KA01#		
			12000pF	±10%	GCD188R72A123KA01#		
			15000pF	±10%	GCD188R72A153KA01#		
			18000pF	±10%	GCD188R72A183KA01#		
			22000pF	±10%	GCD188R72A223KA01#		
			50Vdc	X7R	1000pF	±10%	GCD188R71H102KA01#
					1200pF	±10%	GCD188R71H122KA01#
					1500pF	±10%	GCD188R71H152KA01#
					1800pF	±10%	GCD188R71H182KA01#
					2200pF	±10%	GCD188R71H222KA01#
2700pF	±10%	GCD188R71H272KA01#					
3300pF	±10%	GCD188R71H332KA01#					
3900pF	±10%	GCD188R71H392KA01#					
4700pF	±10%	GCD188R71H472KA01#					
5600pF	±10%	GCD188R71H562KA01#					
6800pF	±10%	GCD188R71H682KA01#					
8200pF	±10%	GCD188R71H822KA01#					
10000pF	±10%	GCD188R71H103KA01#					
12000pF	±10%	GCD188R71H123KA01#					
15000pF	±10%	GCD188R71H153KA01#					
18000pF	±10%	GCD188R71H183KA01#					
22000pF	±10%	GCD188R71H223KA01#					
25Vdc	X7R	27000pF			±10%	GCD188R71E273KA01#	
		33000pF			±10%	GCD188R71E333KA01#	
		39000pF			±10%	GCD188R71E393KA01#	
		47000pF			±10%	GCD188R71E473KA01#	

T max.	Rated Voltage	TC Code	Cap.	Tol.	Part Number
0.7mm	100Vdc	X7R	5600pF	±10%	GCD216R72A562KA01#
0.95mm	100Vdc	X7R	6800pF	±10%	GCD219R72A682KA01#
1.4mm	100Vdc	X7R	8200pF	±10%	GCD21BR72A822KA01#
			10000pF	±10%	GCD21BR72A103KA01#
			12000pF	±10%	GCD21BR72A123KA01#
			15000pF	±10%	GCD21BR72A153KA01#
			18000pF	±10%	GCD21BR72A183KA01#
			22000pF	±10%	GCD21BR72A223KA01#
			27000pF	±10%	GCD21BR72A273KA01#
			33000pF	±10%	GCD21BR72A333KA01#
			39000pF	±10%	GCD21BR72A393KA01#
			47000pF	±10%	GCD21BR72A473KA01#
			56000pF	±10%	GCD21BR72A563KA01#
			68000pF	±10%	GCD21BR72A683KA01#
			82000pF	±10%	GCD21BR72A823KA01#
			0.10μF	±10%	GCD21BR72A104KA01#
	50Vdc	X7R	15000pF	±10%	GCD21BR71H153KA01#
			18000pF	±10%	GCD21BR71H183KA01#
			22000pF	±10%	GCD21BR71H223KA01#
			27000pF	±10%	GCD21BR71H273KA01#
			33000pF	±10%	GCD21BR71H333KA01#
			39000pF	±10%	GCD21BR71H393KA01#
			47000pF	±10%	GCD21BR71H473KA01#
			56000pF	±10%	GCD21BR71H563KA01#
0.10μF	±10%	GCD21BR71H683KA01#			
		GCD21BR71H823KA01#			
			0.10μF	±10%	GCD21BR71H104KA01#

2.0×1.25mm

T max.	Rated Voltage	TC Code	Cap.	Tol.	Part Number
0.7mm	100Vdc	X7R	1000pF	±10%	GCD216R72A102KA01#
			1200pF	±10%	GCD216R72A122KA01#
			1500pF	±10%	GCD216R72A152KA01#
			1800pF	±10%	GCD216R72A182KA01#
			2200pF	±10%	GCD216R72A222KA01#
			2700pF	±10%	GCD216R72A272KA01#
			3300pF	±10%	GCD216R72A332KA01#
			3900pF	±10%	GCD216R72A392KA01#
			4700pF	±10%	GCD216R72A472KA01#

Part number # indicates the package specification code.

Soft Termination MLSC Design Chip Multilayer Ceramic Capacitors for Automotive

GCE Series



Further improved safety performance with a combination of a 2-element array structure & resin external electrodes!

Features

① Avoid instantaneous dielectric breakdown with the 2-element array structure

This product is configured with 2 elements arranged in one capacitor. Even if one element short circuits, the other element in the capacitor does not short.

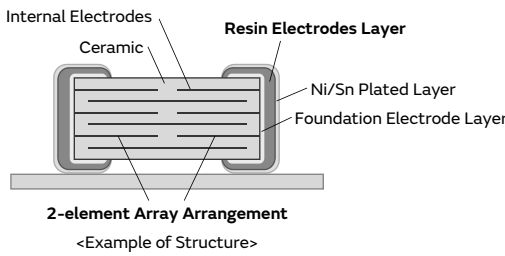

② Provides additional safety performance in combination with resin electrodes

Adopting resin electrodes as the external electrodes will suppress the occurrence of cracking in the capacitor by mechanical stress.

● For Automotive (GCM Series)

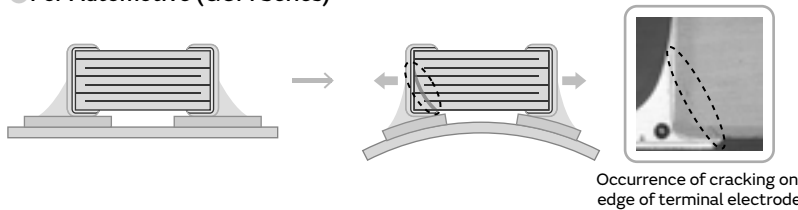

● Fail Safe Design (GCE Series)

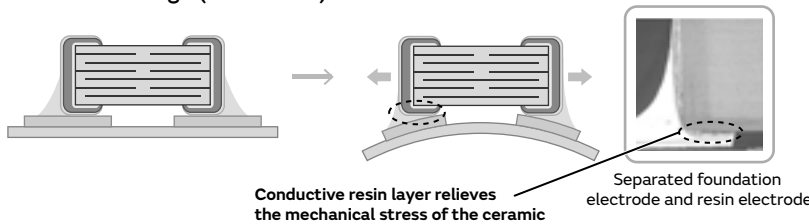

Note: Cracks may occur in the capacitor body if excessive stress beyond the "guaranteed range of board bending strength (*)" provided in the specifications is applied. Capacitors with cracks in them may cause a drop in insulation resistance, which could lead to a short circuit.

(*) For details on the guaranteed range of board bending strength, check the "Detailed Specification Sheet" on the Product Details Page.

③ Ideal for battery lines of on-board applications

Space can be reduced for battery lines, when 2 capacitors are configured in an array.

Specifications

Size	1.6×0.8mm to 2.0×1.25mm
Rated Voltage	25Vdc to 100Vdc
Capacitance	220pF to 0.10μF
Main Applications	For automotive, Battery lines, power trains

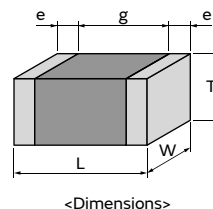

GRT Series

GCM Series

GC3 Series

G CJ Series

GCD Series

GCE Series

NMF Series

KCM Series

KC3 Series

KCA Series

GCG Series

⚠Caution/
 Notice

GCE Series High Dielectric Constant Type Part Number List

1.6×0.8mm

T max.	Rated Voltage	TC Code	Cap.	Tol.	Part Number		
0.9mm	100Vdc	X7R	1000pF	±10%	GCE188R72A102KA01#		
			1200pF	±10%	GCE188R72A122KA01#		
			1500pF	±10%	GCE188R72A152KA01#		
			1800pF	±10%	GCE188R72A182KA01#		
			2200pF	±10%	GCE188R72A222KA01#		
			2700pF	±10%	GCE188R72A272KA01#		
			3300pF	±10%	GCE188R72A332KA01#		
			3900pF	±10%	GCE188R72A392KA01#		
			4700pF	±10%	GCE188R72A472KA01#		
			5600pF	±10%	GCE188R72A562KA01#		
			6800pF	±10%	GCE188R72A682KA01#		
			8200pF	±10%	GCE188R72A822KA01#		
			10000pF	±10%	GCE188R72A103KA01#		
			12000pF	±10%	GCE188R72A123KA01#		
			15000pF	±10%	GCE188R72A153KA01#		
			18000pF	±10%	GCE188R72A183KA01#		
			22000pF	±10%	GCE188R72A223KA01#		
			50Vdc	X7R	1000pF	±10%	GCE188R71H102KA01#
					1200pF	±10%	GCE188R71H122KA01#
					1500pF	±10%	GCE188R71H152KA01#
					1800pF	±10%	GCE188R71H182KA01#
					2200pF	±10%	GCE188R71H222KA01#
2700pF	±10%	GCE188R71H272KA01#					
3300pF	±10%	GCE188R71H332KA01#					
3900pF	±10%	GCE188R71H392KA01#					
4700pF	±10%	GCE188R71H472KA01#					
5600pF	±10%	GCE188R71H562KA01#					
6800pF	±10%	GCE188R71H682KA01#					
8200pF	±10%	GCE188R71H822KA01#					
10000pF	±10%	GCE188R71H103KA01#					
12000pF	±10%	GCE188R71H123KA01#					
15000pF	±10%	GCE188R71H153KA01#					
18000pF	±10%	GCE188R71H183KA01#					
22000pF	±10%	GCE188R71H223KA01#					
25Vdc	X7R	27000pF			±10%	GCE188R71E273KA01#	
		33000pF			±10%	GCE188R71E333KA01#	
		39000pF			±10%	GCE188R71E393KA01#	
		47000pF			±10%	GCE188R71E473KA01#	

T max.	Rated Voltage	TC Code	Cap.	Tol.	Part Number			
0.7mm	100Vdc	X7R	5600pF	±10%	GCE216R72A562KA01#			
0.95mm	100Vdc	X7R	220pF	±10%	GCE219R72A221KA01#			
			270pF	±10%	GCE219R72A271KA01#			
			330pF	±10%	GCE219R72A331KA01#			
			390pF	±10%	GCE219R72A391KA01#			
			470pF	±10%	GCE219R72A471KA01#			
			560pF	±10%	GCE219R72A561KA01#			
			680pF	±10%	GCE219R72A681KA01#			
			820pF	±10%	GCE219R72A821KA01#			
			6800pF	±10%	GCE219R72A682KA01#			
			1.45mm	100Vdc	X7R	8200pF	±10%	GCE21BR72A822KA01#
						10000pF	±10%	GCE21BR72A103KA01#
12000pF	±10%	GCE21BR72A123KA01#						
15000pF	±10%	GCE21BR72A153KA01#						
18000pF	±10%	GCE21BR72A183KA01#						
22000pF	±10%	GCE21BR72A223KA01#						
27000pF	±10%	GCE21BR72A273KA01#						
33000pF	±10%	GCE21BR72A333KA01#						
39000pF	±10%	GCE21BR72A393KA01#						
47000pF	±10%	GCE21BR72A473KA01#						
56000pF	±10%	GCE21BR72A563KA01#						
68000pF	±10%	GCE21BR72A683KA01#						
82000pF	±10%	GCE21BR72A823KA01#						
0.10μF	±10%	GCE21BR72A104KA01#						
50Vdc	X7R	15000pF				±10%	GCE21BR71H153KA01#	
		18000pF		±10%	GCE21BR71H183KA01#			
		22000pF		±10%	GCE21BR71H223KA01#			
		27000pF		±10%	GCE21BR71H273KA01#			
		33000pF		±10%	GCE21BR71H333KA01#			
		39000pF		±10%	GCE21BR71H393KA01#			
		47000pF		±10%	GCE21BR71H473KA01#			
		56000pF		±10%	GCE21BR71H563KA01#			
		68000pF		±10%	GCE21BR71H683KA01#			
		82000pF		±10%	GCE21BR71H823KA01#			
		0.10μF		±10%	GCE21BR71H104KA01#			

2.0×1.25mm

T max.	Rated Voltage	TC Code	Cap.	Tol.	Part Number
0.7mm	100Vdc	X7R	1000pF	±10%	GCE216R72A102KA01#
			1200pF	±10%	GCE216R72A122KA01#
			1500pF	±10%	GCE216R72A152KA01#
			1800pF	±10%	GCE216R72A182KA01#
			2200pF	±10%	GCE216R72A222KA01#
			2700pF	±10%	GCE216R72A272KA01#
			3300pF	±10%	GCE216R72A332KA01#
			3900pF	±10%	GCE216R72A392KA01#
			4700pF	±10%	GCE216R72A472KA01#

Part number # indicates the package specification code.

Very Large Current 3 Terminals Low ESL Chip Multilayer Ceramic Capacitors for Automotive (EMIFIL®)

NFM Series



This is the most suitable Low ESL capacitors for noise measurement and power decoupling of highspeed electrical devices.

Features

① Low ESL

Since the equivalent series inductance (ESL) is low and excellent in high frequency characteristics, this capacitor is suitable for power supply decoupling of high-speed operation electronic equipment.

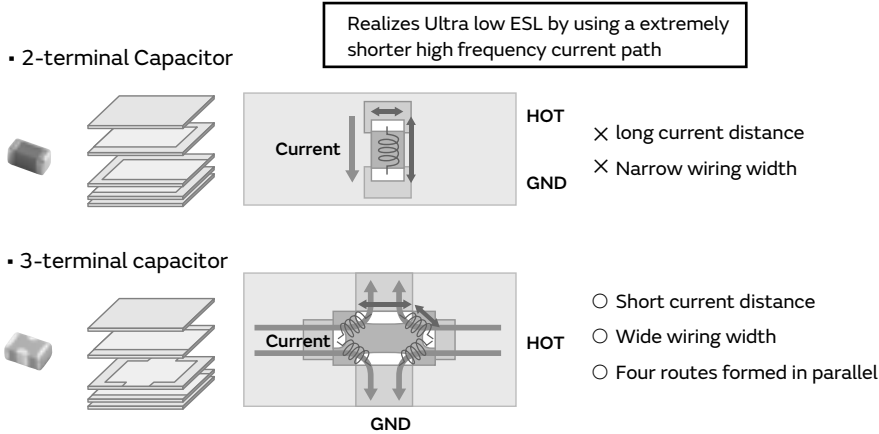

② Contributes to a reduction in the number of components.

The number of components can be reduced by using low ESL capacitors, while maintaining functions equivalent to 2-terminal capacitor.

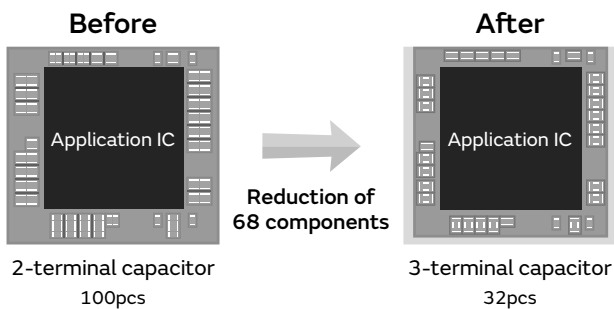

③ Contributes to noise suppression

Example of noise suppression effect

Specifications

Size	2.0×1.25mm to 3.2×1.6mm
Rated Voltage	10Vdc to 100Vdc
Capacitance	220pF to 1.0μF
Main Applications	Safety equipment, Drive system control, Information and Comfort equipment

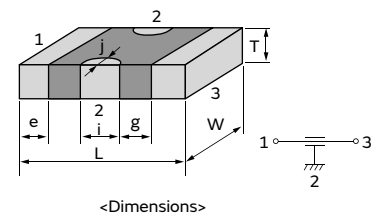

GRT Series
 GCM Series
 GC3 Series
 GCJ Series
 GCD Series
 GCE Series
 NFM Series
 KCM Series
 KC3 Series
 KCA Series
 GCG Series
 △Caution /Notice

GRT Series

GCM Series

GC3 Series

GCJ Series

GCD Series

GCE Series

NMF Series

KCM Series

KC3 Series

KCA Series

GCG Series

Caution/
 Notice

NFM Series     **Part Number List**

2.0×1.25mm

T max.	Rated Voltage	Cap.	Tol.	Part Number	
0.95mm	50Vdc	220pF	±20%	NFM21HC221R1H3#	
		470pF	±20%	NFM21HC471R1H3#	
		1000pF	±20%	NFM21HC102R1H3#	
		2200pF	±20%	NFM21HC222R1H3#	
		22000pF	±20%	NFM21HC223R1H3#	
	16Vdc	1.0μF	±20%	NFM21HC105R1C3#	
	10Vdc	0.10μF	±20%	NFM21HC104R1A3#	
		0.22μF	±20%	NFM21HC224R1A3#	
		0.47μF	±20%	NFM21HC474R1A3#	

3.2×1.6mm

T max.	Rated Voltage	Cap.	Tol.	Part Number	
1.5mm	100Vdc	10000pF	±20%	NFM31HK103R2A3#	D3
	50Vdc	10000pF	±20%	NFM31HK103R1H3#	D3
		15000pF	±20%	NFM31HK153R1H3#	D3
		22000pF	±20%	NFM31HK223R1H3#	D3
		0.10μF	±20%	NFM31HK104R1H3#	

Metal Terminal Type Multilayer Ceramic Capacitors for Automotive

KCM Series



Bonding the metal terminals to external electrodes solves design issues by mounting large size MLCC!

Features

① **Bond metal terminals to the external electrodes of chips.**

The stress applied to the chip is relieved by the elastic action of the metal terminal.

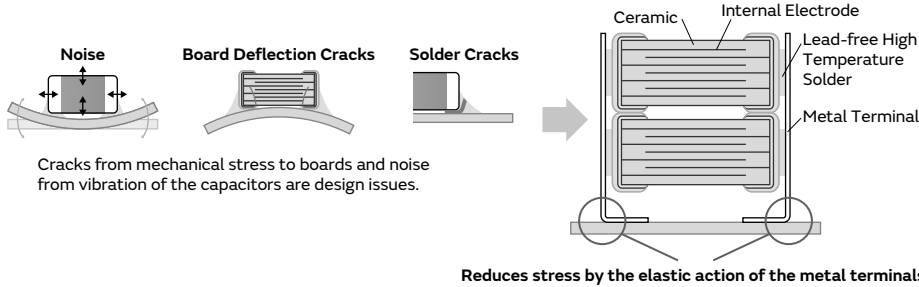

② **Substantially reduces noise, board deflection cracks and soldering cracks.**

This product is not damaged even with a board deflection of 6 mm.
 Solder cracks do not occur even with 2,000 cycles of heat stress.

● **Comparison of Noise Reduction Effects**

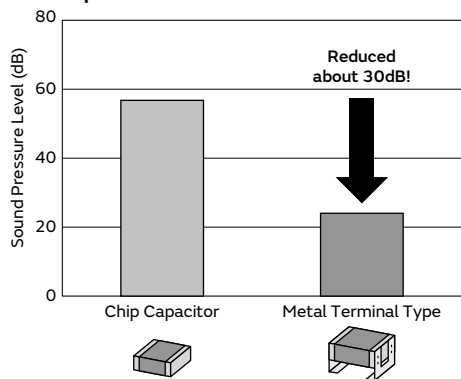

Evaluation Items: 5750 (in mm)/2220 (in inch) size/DC630V/220nF
 Test Method: DC50V, AC10Vp-p/3kHz
 Test Board: Glass Epoxy Board (T=1.6mm)
 Test Quantity: 3pc
 Distance Between Microphone and Board: 5mm

Note: Results Using Murata's Evaluation Board

● **Reduces Stress Caused by Board Deflection**

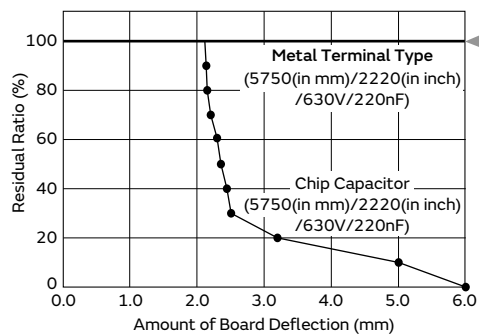

No damage, even with 6 mm board deflection!!

● **Suppresses Solder Cracks Caused by Heat Stress**

Chip Size	Chip Only (5750 (in mm)/2220 (in inch) size)		Metal Terminal Type (5750 (in mm)/2220 (in inch) size)	
1000 Cycles				
2000 Cycles				

Compared with chips only, this product is excellent in solder cracking resistance.

Test Condition: -55 to +125°C, 5min., (Liquid Phase)
 Board Used: Glass Epoxy Board (FR-4)

GRT Series

GCM Series

GC3 Series

GCJ Series

GCD Series

GCE Series

NMF Series

KCM Series

KC3 Series

KCA Series

GCG Series

Caution/
 Notice

③ **2 chips can be stacked.**

Realize large capacity by stacking 2 capacitors.

Specifications

Size	6.1×5.3mm
Rated Voltage	25Vdc to 100Vdc
Capacitance	4.7μF to 100μF
Main Applications	For drive system control of engine ECU For other drive system controls and safety devices

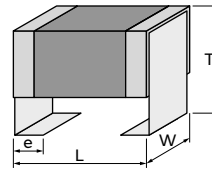

<Dimensions>

KCM Series High Dielectric Constant Type Part Number List

6.1×5.3mm

T max.	Rated Voltage	TC Code	Cap.	Tol.	Part Number
3.0mm	100Vdc	X7R	4.7μF	±10%	KCM55LR72A475KH01#
	63Vdc	X7R	4.7μF	±10%	KCM55LR71J475KH01#
	50Vdc	X7R	4.7μF	±10%	KCM55LR71H475KH01#
			10μF	±10%	KCM55LR71H106KH01#
	35Vdc	X7R	10μF	±10%	KCM55LR7YA106KH01#
			15μF	±10%	KCM55LR7YA156KH01#
25Vdc	X7R	15μF	±10%	KCM55LR71E156KH01#	
3.9mm	100Vdc	X7R	6.8μF	±10%	KCM55QR72A685KH01#
			10μF	±10%	KCM55QR72A106KH01#
	63Vdc	X7R	10μF	±10%	KCM55QR71J106KH01#
	50Vdc	X7R	17μF	±10%	KCM55QR71H176KH01#
	35Vdc	X7R	17μF	±10%	KCM55QR7YA176KH01#
			22μF	±10%	KCM55QR7YA226KH01#
	25Vdc	X7R	22μF	±10%	KCM55QR71E226KH01#
			33μF	±10%	KCM55QR71E336KH01#
			X7S	47μF	±10%
5.0mm	100Vdc	X7R	10μF	±20%	KCM55TR72A106MH01#
	50Vdc	X7R	22μF	±20%	KCM55TR71H226MH01#
	35Vdc	X7R	22μF	±20%	KCM55TR7YA226MH01#
			33μF	±20%	KCM55TR7YA336MH01#
	25Vdc	X7R	33μF	±20%	KCM55TR71E336MH01#
6.7mm	100Vdc	X7R	15μF	±20%	KCM55WR72A156MH01#
			22μF	±20%	KCM55WR72A226MH01#
	63Vdc	X7R	22μF	±20%	KCM55WR71J226MH01#
	50Vdc	X7R	33μF	±20%	KCM55WR71H336MH01#
	35Vdc	X7R	47μF	±20%	KCM55WR7YA476MH01#
	25Vdc	X7R	47μF	±20%	KCM55WR71E476MH01#
			68μF	±20%	KCM55WR71E686MH01#
			X7S	100μF	±20%

GRT Series
 GCM Series
 GC3 Series
 GCJ Series
 GCD Series
 GCE Series
 NMF Series
 KCM Series
 KC3 Series
 KCA Series
 GCG Series
 △Caution /Notice

GRT Series

GCM Series

GC3 Series

GCM Series

GCD Series

GCE Series

NMF Series

KCM Series

KC3 Series

KCA Series

GCG Series

Caution/Notice

High Effective Capacitance & High Allowable Ripple Current Metal Terminal Type Multilayer Ceramic Capacitors for Automotive

KC3 Series



Bonding the metal terminals to external electrodes solves design issues by mounting large size MLCC!

Features

1 Bond Metal Terminals to External Electrodes of Chips

This product has high resistance to heat and mechanical impact and greatly reduces acoustic noise of boards by ceramics.

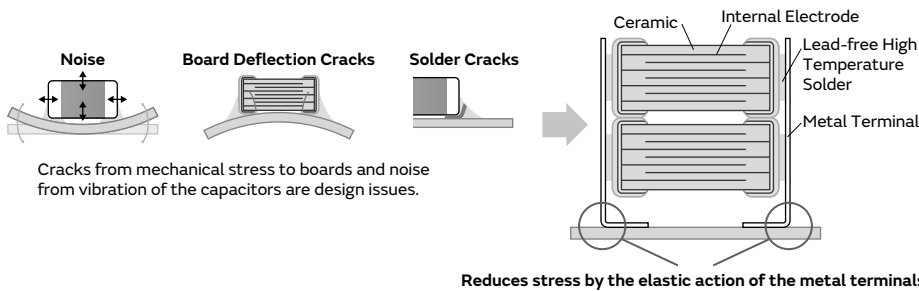

2 Stacking of Chips

Achieve high capacity by stacking 2 capacitors.

● Comparison of Noise Reduction Effects

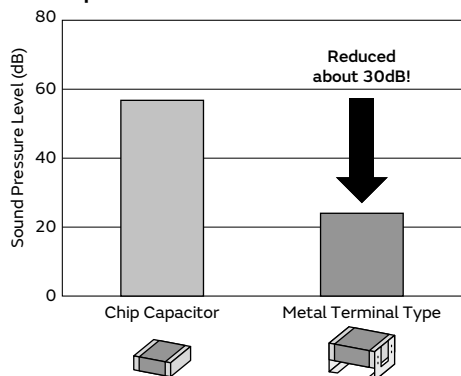

Evaluation Items: 5750 (in mm)/2220 (in inch) size/DC630V/220nF
 Test Method: DC50V, AC10Vp-p/3kHz
 Test Board: Glass Epoxy Board (T=1.6mm)
 Test Quantity: 3pc
 Distance Between Microphone and Board: 5mm

Note: Results Using Murata's Evaluation Board

● Reduces Stress Caused by Board Deflection

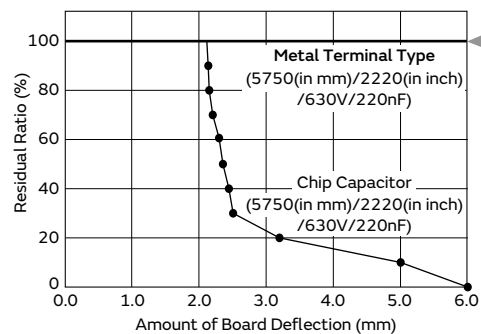

No damage, even with 6 mm board deflection!!

● Suppresses Solder Cracks Caused by Heat Stress

Chip Size	Chip Only (5750 (in mm)/2220 (in inch) size)	Metal Terminal Type (5750 (in mm)/2220 (in inch) size)
1000 Cycles	 ↑ Solder Crack	
2000 Cycles	 ↑ Solder Crack	

Compared with chips only, this product is excellent in solder cracking resistance.

Test Condition: -55 to +125°C, 5min., (Liquid Phase)
 Board Used: Glass Epoxy Board (FR-4)

3 Adopted Low Dielectric Constant Materials

Improved effective capacity and ripple resistant performance, compared to conventional products (X7R characteristics).

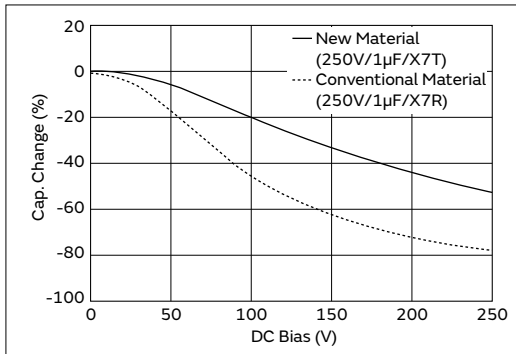

4 2 chips can be stacked

Realize large capacity by stacking 2 capacitors.

Specifications

Size	6.1×5.3mm
Rated Voltage	250Vdc to 630Vdc
Capacitance	0.10µF to 2.2µF
Main Applications	For drive system control of engine ECU For other drive system controls and safety devices

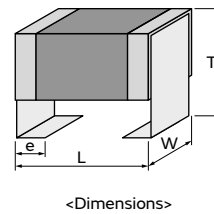

GRT Series

GCM Series

GC3 Series

G CJ Series

GCD Series

GCE Series

NMF Series

KCM Series

KC3 Series

KCA Series

GCG Series

⚠Caution /Notice

55

KC3 Series High Dielectric Constant Type Part Number List

6.1×5.3mm

T max.	Rated Voltage	TC Code	Cap.	Tol.	Part Number
3.0mm	630Vdc	X7T	0.10μF	±10%	KC355LD72J104KH01#
			0.15μF	±10%	KC355LD72J154KH01#
			0.33μF	±10%	KC355LD7LQ334KV01#
			0.47μF	±10%	KC355LD7LQ474KV01#
	450Vdc	X7T	0.22μF	±10%	KC355LD72W224KH01#
			0.33μF	±10%	KC355LD72W334KH01#
			0.47μF	±10%	KC355LD72W474KH01#
			0.68μF	±10%	KC355LD7LP684KV01#
	250Vdc	X7T	0.47μF	±10%	KC355LD72E474KH01#
			0.68μF	±10%	KC355LD72E684KH01#
3.9mm	630Vdc	X7T	0.22μF	±10%	KC355QD72J224KH01#
			0.27μF	±10%	KC355QD72J274KH01#
			0.56μF	±10%	KC355QD7LQ564KV01#
	450Vdc	X7T	0.56μF	±10%	KC355QD72W564KH01#
			1μF	±10%	KC355QD7LP105KV01#
	250Vdc	X7T	1.0μF	±10%	KC355QD72E105KH01#
	5.0mm	630Vdc	X7T	0.68μF	±20%
1μF				±20%	KC355TD7LQ105MV01#
450Vdc		X7T	0.68μF	±20%	KC355TD72W684MH01#
			1.0μF	±20%	KC355TD72W105MH01#
			1.5μF	±20%	KC355TD7LP155MV01#
250Vdc		X7T	1.5μF	±20%	KC355TD72E155MH01#
6.7mm		630Vdc	X7T	0.47μF	±20%
	0.56μF			±20%	KC355WD72J564MH01#
	1.2μF			±20%	KC355WD7LQ125MV01#
	450Vdc	X7T	1.2μF	±20%	KC355WD72W125MH01#
			2.2μF	±20%	KC355WD7LP225MV01#
	250Vdc	X7T	2.2μF	±20%	KC355WD72E225MH01#

GRT Series
 GCM Series
 GC3 Series
 GCJ Series
 GCD Series
 GCE Series
 NMF Series
 KCM Series
 KC3 Series
 KCA Series
 GCG Series
 Caution/Notice

Safety Standard Certified Metal Terminal Type Multilayer Ceramic Capacitors for Automotive

KCA Series



For Automotive IEC60384-14 X1/Y2 Class Certified Product (Basic insulation product)

Features

- ① **International Standard (IEC60384-14) certified product: Rated voltage AC250V (r.m.s.).**

Please down load Safety Standard Certification (Type MF: X1,Y2) from Web site.

- ② **Best suitable for class Y2 capacitors.**

AC250V (r.m.s.)-rated voltage, withstand voltage of AC2000V (r.m.s.) guaranteed for 60 seconds.

● **OBC (On Board Charger)**

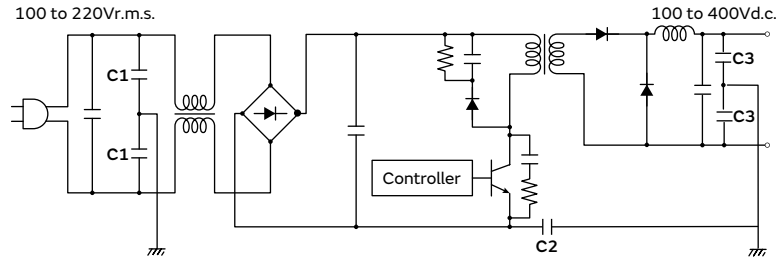

No.	Application
C1	Y Cap (Primary)
C2	Primary-Secondary Coupling
C3	Y Cap (Secondary)

- ③ **Best suitable for DC input common mode noise filters.**

DC630V-rated voltage, withstand voltage of DC2700V guaranteed for 60 seconds.

● **Inverter**

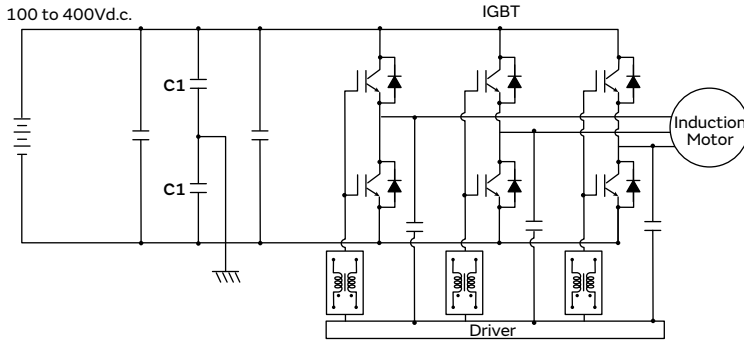

No.	Application
C1	Common mode noise filters

● **DC-DC Converter**

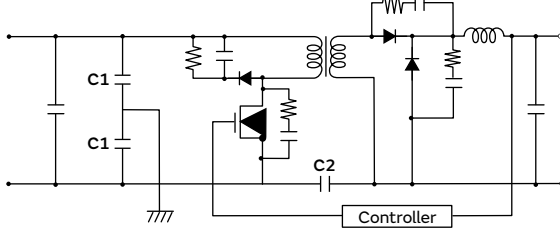

No.	Application
C1	Common mode noise filters
C2	Primary-Secondary Coupling

GRT Series
 GCM Series
 GC3 Series
 GCJ Series
 GCD Series
 GCE Series
 NMF Series
 KCM Series
 KC3 Series
 KCA Series
 GCG Series
 ⚠Caution / Notice

GRT Series

GCM Series

GC3 Series

GCM Series

GCD Series

GCE Series

NMF Series

KCM Series

KC3 Series

KCA Series

GCG Series

Caution/ Notice

4 Bond metal terminals to the external electrodes of chips.

The stress applied to the chip is relieved by the elastic action of the metal terminal.

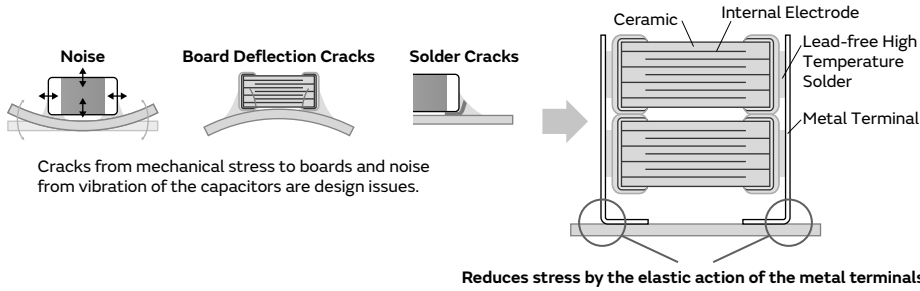

5 Substantially reduces board deflection cracks and soldering cracks.

This product is not damaged even with a board deflection of 6 mm. Solder cracks do not occur even with 2,000 cycles of heat stress.

● Reduces Stress Caused by Board Deflection

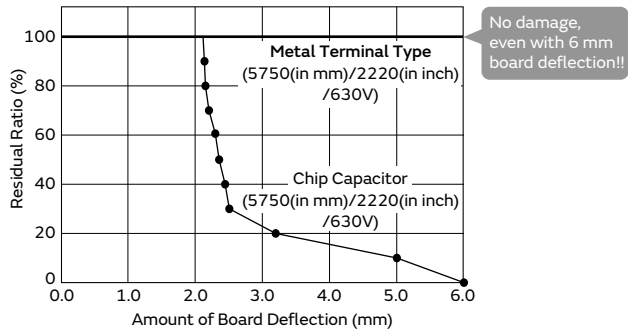

● Suppresses Solder Cracks Caused by Heat Stress

Chip Size	Chip Only (5750 (in mm)/2220 (in inch) size)	Metal Terminal Type (5750 (in mm)/2220 (in inch) size)
1000 Cycles	 ↑ Solder Crack	
2000 Cycles	 ↑ Solder Crack	

Compared with chips only, this product is excellent in solder cracking resistance.

Test Condition: -55 to +125°C, 5min., (Liquid Phase)
 Board Used: Glass Epoxy Board (FR-4)

6 2 chips can be stacked.

Realize large capacity by stacking 2 capacitors.

Specifications

Size	6.1×5.3mm
Rated Voltage	250Vac (r.m.s.)
Capacitance	100pF to 10000pF
Main Applications	Battery chargers, Inverter, DC-DC converters

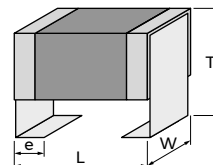

<Dimensions>

KCA Series Temperature Compensating Type Part Number List

6.1×5.3mm

T max.	Rated Voltage	TC Code	Cap.	Tol.	Part Number
3.0mm	250Vac(r.m.s.)	U2J	100pF	±10%	KCA55L7UMF101KH01#
			150pF	±10%	KCA55L7UMF151KH01#
			220pF	±10%	KCA55L7UMF221KH01#
			330pF	±10%	KCA55L7UMF331KH01#
			470pF	±10%	KCA55L7UMF471KH01#
			680pF	±10%	KCA55L7UMF681KH01#
			1000pF	±10%	KCA55L7UMF102KH01#
			1500pF	±10%	KCA55L7UMF152KH01#
			2200pF	±10%	KCA55L7UMF222KH01#
			3300pF	±10%	KCA55L7UMF332KH01#
3.9mm	250Vac(r.m.s.)	U2J	4700pF	±10%	KCA55Q7UMF472KH01#
5.0mm	250Vac(r.m.s.)	U2J	6800pF	±20%	KCA55T7UMF682MH01#
6.7mm	250Vac(r.m.s.)	U2J	10000pF	±20%	KCA55W7UMF103MH01#

GRT Series

GCM Series

GC3 Series

GCC Series

GCD Series

GCE Series

NMF Series

KCM Series

KC3 Series

KCA Series

GCG Series

⚠Caution /Notice

GRT Series

GCM Series

GC3 Series

GCM Series

GCD Series

GCE Series

NMF Series

KCM Series

KC3 Series

KCA Series

GCG Series

Caution/Notice

AgPd Termination Conductive Glue Mounting Chip Multilayer Ceramic Capacitors for Automotive

GCG Series



Improved mechanical and thermal strength by adopting AgPd external electrodes, which can be mounted with a conductive glue!

Features

1 Limited to Conductive Glue Mounting

This capacitor can be mounted with a conductive adhesive* in powertrains and safety devices of automotive.

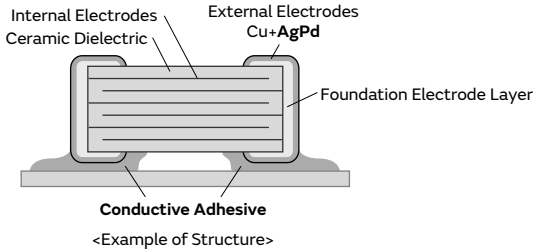

2 Adopted AgPd external electrodes

Adopted AgPd, which is excellent in bonding strength with a conductive adhesive.

3 Compatible up to 150°C

This capacitor lineup with X8L and X8R characteristics can be used in high temperature environments, such as in ABS and transmission control.

* This product is for use exclusively with conductive glue mounting. It cannot be used with any mounting methods other than conductive glue mounting.

Using solder to mount the product can result in insufficient wetting, insufficient bonding strength, and/or leaching of the Ag/Pd External Electrodes (terminations), which can cause quality problems such as the chip coming loose.

Specifications

Size	1.0×0.5mm to 3.2×2.5mm
Rated Voltage	6.3Vdc to 100Vdc
Capacitance	1.0pF to 47μF
Main Applications	For automotive, power trains, sensors

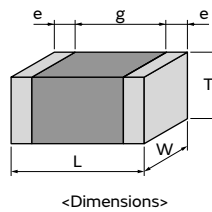

GCG Series Temperature Compensating Type Power-train AEC-Q200 Deflecting crack Soldering crack Limited to conductive glue mounting Part Number List

1.0×0.5mm

T max.	Rated Voltage	TC Code	Cap.	Tol.	Part Number
0.55mm	50Vdc	X8G	120pF	±5%	GCG1555G1H121JA01#
			150pF	±5%	GCG1555G1H151JA01#
			180pF	±5%	GCG1555G1H181JA01#
			220pF	±5%	GCG1555G1H221JA01#
			270pF	±5%	GCG1555G1H271JA01#
			330pF	±5%	GCG1555G1H331JA01#
			390pF	±5%	GCG1555G1H391JA01#
			470pF	±5%	GCG1555G1H471JA01#

T max.	Rated Voltage	TC Code	Cap.	Tol.	Part Number
0.7mm	50Vdc	X8G	2700pF	±5%	GCG2165G1H272JA01#
			3300pF	±5%	GCG2165G1H332JA01#
			3900pF	±5%	GCG2165G1H392JA01#
			4700pF	±5%	GCG2165G1H472JA01#
0.95mm	50Vdc	X8G	5600pF	±5%	GCG2195G1H562JA01#
			6800pF	±5%	GCG2195G1H682JA01#
			8200pF	±5%	GCG2195G1H822JA01#
			10000pF	±5%	GCG2195G1H103JA01#

1.6×0.8mm

T max.	Rated Voltage	TC Code	Cap.	Tol.	Part Number
0.9mm	50Vdc	X8G	10pF	±5%	GCG1885G1H100JA01#
			12pF	±5%	GCG1885G1H120JA01#
			15pF	±5%	GCG1885G1H150JA01#
			18pF	±5%	GCG1885G1H180JA01#
			22pF	±5%	GCG1885G1H220JA01#
			27pF	±5%	GCG1885G1H270JA01#
			33pF	±5%	GCG1885G1H330JA01#
			39pF	±5%	GCG1885G1H390JA01#
			47pF	±5%	GCG1885G1H470JA01#
			56pF	±5%	GCG1885G1H560JA01#
			68pF	±5%	GCG1885G1H680JA01#
			82pF	±5%	GCG1885G1H820JA01#
			100pF	±5%	GCG1885G1H101JA01#
			120pF	±5%	GCG1885G1H121JA01#
			150pF	±5%	GCG1885G1H151JA01#
			180pF	±5%	GCG1885G1H181JA01#
			220pF	±5%	GCG1885G1H221JA01#
			270pF	±5%	GCG1885G1H271JA01#
			330pF	±5%	GCG1885G1H331JA01#
			390pF	±5%	GCG1885G1H391JA01#
			470pF	±5%	GCG1885G1H471JA01#
			560pF	±5%	GCG1885G1H561JA01#
			680pF	±5%	GCG1885G1H681JA01#
			820pF	±5%	GCG1885G1H821JA01#
			1000pF	±5%	GCG1885G1H102JA01#
			1200pF	±5%	GCG1885G1H122JA01#
1500pF	±5%	GCG1885G1H152JA01#			
1800pF	±5%	GCG1885G1H182JA01#			
2200pF	±5%	GCG1885G1H222JA01#			

2.0×1.25mm

T max.	Rated Voltage	TC Code	Cap.	Tol.	Part Number
0.7mm	50Vdc	X8G	1000pF	±5%	GCG2165G1H102JA01#
			1200pF	±5%	GCG2165G1H122JA01#
			1500pF	±5%	GCG2165G1H152JA01#
			1800pF	±5%	GCG2165G1H182JA01#
			2200pF	±5%	GCG2165G1H222JA01#

Part number # indicates the package specification code.

GCG Series High Dielectric Constant Type Power-train AEC-Q200 Defecting crack Soldering crack Limited to conductive glue mounting Part Number List

1.0×0.5mm

T max.	Rated Voltage	TC Code	Cap.	Tol.	Part Number		
0.55mm	50Vdc	X7R	220pF	±10%	GCG155R71H221KA01#		
			270pF	±10%	GCG155R71H271KA01#		
			330pF	±10%	GCG155R71H331KA01#		
			390pF	±10%	GCG155R71H391KA01#		
			470pF	±10%	GCG155R71H471KA01#		
			560pF	±10%	GCG155R71H561KA01#		
			680pF	±10%	GCG155R71H681KA01#		
			820pF	±10%	GCG155R71H821KA01#		
			1000pF	±10%	GCG155R71H102KA01#		
			1200pF	±10%	GCG155R71H122KA01#		
			1500pF	±10%	GCG155R71H152KA01#		
			1800pF	±10%	GCG155R71H182KA01#		
			2200pF	±10%	GCG155R71H222KA01#		
			2700pF	±10%	GCG155R71H272KA01#		
			3300pF	±10%	GCG155R71H332KA01#		
			3900pF	±10%	GCG155R71H392KA01#		
			4700pF	±10%	GCG155R71H472KA01#		
			25Vdc	X8L	5600pF	±10%	GCG155L81E562KA01#
					6800pF	±10%	GCG155L81E682KA01#
					8200pF	±10%	GCG155L81E822KA01#
	10000pF	±10%			GCG155L81E103KA01#		
	X7R	5600pF		±10%	GCG155R71E562KA01#		
		6800pF		±10%	GCG155R71E682KA01#		
		8200pF		±10%	GCG155R71E822KA01#		
		10000pF		±10%	GCG155R71E103KA01#		
		16Vdc		X8L	15000pF	±10%	GCG155L81C153KA01#
					18000pF	±10%	GCG155L81C183KA01#
					22000pF	±10%	GCG155L81C223KA01#
					27000pF	±10%	GCG155L81C273KA01#
	33000pF		±10%		GCG155L81C333KA01#		
	39000pF		±10%		GCG155L81C393KA01#		
	47000pF		±10%		GCG155L81C473KA01#		
	X7R		15000pF		±10%	GCG155R71C153KA01#	
			18000pF	±10%	GCG155R71C183KA01#		
			22000pF	±10%	GCG155R71C223KA01#		
			27000pF	±10%	GCG155R71C273KA01#		
	0.10μF		X7R	33000pF	±10%	GCG155R71C333KA01#	
		39000pF		±10%	GCG155R71C393KA01#		
		47000pF		±10%	GCG155R71C473KA01#		
		56000pF		±10%	GCG155R71C563KA01#		
		68000pF		±10%	GCG155R71C683KA01#		
		82000pF		±10%	GCG155R71C823KA01#		
		0.10μF		±10%	GCG155R71C104KA01#		

1.6×0.8mm

T max.	Rated Voltage	TC Code	Cap.	Tol.	Part Number
0.9mm	100Vdc	X8R	1000pF	±10%	GCG188R92A102KA01#
			1200pF	±10%	GCG188R92A122KA01#
			1500pF	±10%	GCG188R92A152KA01#
			1800pF	±10%	GCG188R92A182KA01#

T max.	Rated Voltage	TC Code	Cap.	Tol.	Part Number
0.9mm	100Vdc	X8R	2200pF	±10%	GCG188R92A222KA01#
			2700pF	±10%	GCG188R92A272KA01#
			3300pF	±10%	GCG188R92A332KA01#
			3900pF	±10%	GCG188R92A392KA01#
			4700pF	±10%	GCG188R92A472KA01#
			5600pF	±10%	GCG188R92A562KA01#
			6800pF	±10%	GCG188R92A682KA01#
			8200pF	±10%	GCG188R92A822KA01#
			10000pF	±10%	GCG188R92A103KA01#
			12000pF	±10%	GCG188R92A123KA01#
			15000pF	±10%	GCG188R92A153KA01#
			18000pF	±10%	GCG188R92A183KA01#
			22000pF	±10%	GCG188R92A223KA01#
			27000pF	±10%	GCG188R92A273KA01#
			33000pF	±10%	GCG188R92A333KA01#
			39000pF	±10%	GCG188R92A393KA01#
			47000pF	±10%	GCG188R92A473KA01#
			56000pF	±10%	GCG188R92A563KA01#
			68000pF	±10%	GCG188R92A683KA01#
			0.10μF	±10%	GCG188R92A104KA03#
	50Vdc	X8L	220pF	±10%	GCG188L81H221KA01#
			270pF	±10%	GCG188L81H271KA01#
			330pF	±10%	GCG188L81H331KA01#
			390pF	±10%	GCG188L81H391KA01#
			470pF	±10%	GCG188L81H471KA01#
			560pF	±10%	GCG188L81H561KA01#
			680pF	±10%	GCG188L81H681KA01#
			820pF	±10%	GCG188L81H821KA01#
			1000pF	±10%	GCG188L81H102KA01#
			1200pF	±10%	GCG188L81H122KA01#
			1500pF	±10%	GCG188L81H152KA01#
			1800pF	±10%	GCG188L81H182KA01#
		X8R	1200pF	±10%	GCG188R91H122KA03#
			1500pF	±10%	GCG188R91H152KA03#
			2200pF	±10%	GCG188R91H222KA03#
			2700pF	±10%	GCG188R91H272KA03#
			3300pF	±10%	GCG188R91H332KA03#
			3900pF	±10%	GCG188R91H392KA03#
			4700pF	±10%	GCG188R91H472KA03#
			5600pF	±10%	GCG188R91H562KA03#
			6800pF	±10%	GCG188R91H682KA03#
			8200pF	±10%	GCG188R91H822KA03#
			10000pF	±10%	GCG188R91H103KA03#
			12000pF	±10%	GCG188R91H123KA03#
15000pF	±10%	GCG188R91H153KA03#			
18000pF	±10%	GCG188R91H183KA03#			
22000pF	±10%	GCG188R91H223KA03#			
0.15μF	±10%	GCG188L8EH154KA07#			
0.22μF	±10%	GCG188L8EH224KA07#			

Part number # indicates the package specification code.

GRT Series

GCM Series

GC3 Series

G CJ Series

GCD Series

GCE Series

NMF Series

KCM Series

KC3 Series

KCA Series

GCG Series

⚠Caution/ Notice

GCG Series High Dielectric Constant Type Part Number List

(→ 1.6×0.8mm)

T max.	Rated Voltage	TC Code	Cap.	Tol.	Part Number	
0.9mm	50Vdc	X8R	5600pF	±10%	GCG188R91H562KA03#	
			6800pF	±10%	GCG188R91H682KA03#	
			8200pF	±10%	GCG188R91H822KA03#	
			10000pF	±10%	GCG188R91H103KA03#	
			15000pF	±10%	GCG188R91H153KA03#	
			22000pF	±10%	GCG188R91H223KA03#	
			33000pF	±10%	GCG188R91H333KA03#	
			47000pF	±10%	GCG188R91H473KA03#	
			0.10μF	±10%	GCG188R91H104KA01#	
			0.12μF	±10%	GCG188R91H124KA01#	
			0.15μF	±10%	GCG188R91H154KA01#	
			0.18μF	±10%	GCG188R91H184KA01#	
			0.22μF	±10%	GCG188R91H224KA01#	
			X7R	10000pF	±10%	GCG188R71H103KA01#
				15000pF	±10%	GCG188R71H153KA01#
		22000pF		±10%	GCG188R71H223KA01#	
		27000pF		±10%	GCG188R71H273KA12#	
		33000pF		±10%	GCG188R71H333KA12#	
		39000pF		±10%	GCG188R71H393KA12#	
		47000pF		±10%	GCG188R71H473KA12#	
		56000pF		±10%	GCG188R71H563KA12#	
		68000pF		±10%	GCG188R71H683KA12#	
		82000pF		±10%	GCG188R71H823KA12#	
		0.10μF		±10%	GCG188R71H104KA01#	
		0.15μF		±10%	GCG188R71H154KA01#	
		0.22μF	±10%	GCG188R71H224KA01#		
		25Vdc	X8R	1000pF	±10%	GCG188R91E102KA01#
	1200pF			±10%	GCG188R91E122KA01#	
	1500pF			±10%	GCG188R91E152KA01#	
	1800pF			±10%	GCG188R91E182KA01#	
	2200pF			±10%	GCG188R91E222KA01#	
	2700pF			±10%	GCG188R91E272KA01#	
	3300pF			±10%	GCG188R91E332KA01#	
	3900pF			±10%	GCG188R91E392KA01#	
	4700pF			±10%	GCG188R91E472KA01#	
	5600pF			±10%	GCG188R91E562KA01#	
	6800pF			±10%	GCG188R91E682KA01#	
	8200pF			±10%	GCG188R91E822KA01#	
	10000pF			±10%	GCG188R91E103KA01#	
	15000pF			±10%	GCG188R91E153KA01#	
	22000pF			±10%	GCG188R91E223KA01#	
	33000pF		±10%	GCG188R91E333KA01#		
	47000pF		±10%	GCG188R91E473KA01#		
	68000pF		±10%	GCG188R91E683KA03#		
	0.33μF		±10%	GCG188R91E334KA01#		
	0.39μF		±10%	GCG188R91E394KA01#		
	0.47μF		±10%	GCG188R91E474KA01#		
X7R	0.12μF		±10%	GCG188R71E124KA12#		
	0.15μF		±10%	GCG188R71E154KA12#		
	0.18μF		±10%	GCG188R71E184KA12#		
	0.22μF		±10%	GCG188R71E224KA12#		
	16Vdc		X8L	0.15μF	±10%	GCG188L81C154KA01#
				0.22μF	±10%	GCG188L81C224KA01#
X8L		0.15μF	±10%	GCG188L81C154KA01#		
		1.0μF	±10%	GCG188L8EE105KA07#		

T max.	Rated Voltage	TC Code	Cap.	Tol.	Part Number
0.9mm	16Vdc	X8R	6800pF	±10%	GCG188R91C683KA01#
			0.10μF	±10%	GCG188R91C104KA01#
		X7R	1.0μF	±10%	GCG188R71C105KA01#
	10Vdc	X7S	2.2μF	±10%	GCG188C71A225KE01#
	6.3Vdc	X7R	2.2μF	±10%	GCG188R70J225KE01#

2.0×1.25mm

T max.	Rated Voltage	TC Code	Cap.	Tol.	Part Number		
0.95mm	50Vdc	X8R	18000pF	±10%	GCG219R91H183KA03#		
1.45mm	100Vdc	X7R	10000pF	±10%	GCG21BR72A103KA01#		
			50Vdc	X8L	27000pF	±10%	GCG21BL81H273KA01#
			33000pF		±10%	GCG21BL81H333KA01#	
			39000pF		±10%	GCG21BL81H393KA01#	
			47000pF		±10%	GCG21BL81H473KA01#	
			0.10μF		±10%	GCG21BL81H104KA03#	
			1.0μF		±10%	GCG21BL8EH105KA07#	
		X8R	56000pF		±10%	GCG21BR91H563KA03#	
			68000pF	±10%	GCG21BR91H683KA03#		
			0.10μF	±10%	GCG21BR91H104KA03#		
			X7R	0.15μF	±10%	GCG21BR71H154KA01#	
				0.18μF	±10%	GCG21BR71H184KA01#	
				0.22μF	±10%	GCG21BR71H224KA01#	
		0.33μF		±10%	GCG21BR71H334KA01#		
		0.47μF		±10%	GCG21BR71H474KA01#		
	1.0μF	±10%		GCG21BR71H105KA01#			
	1.0μF	±10%		GCG21BR7YA105KA01#			
	35Vdc	X8L	0.68μF	±10%	GCG21BL8EG684KA07#		
			1.0μF	±10%	GCG21BL8EG105KA07#		
			X7R	0.68μF	±10%	GCG21BR7YA684KA01#	
		1.0μF		±10%	GCG21BR7YA105KA01#		
		25Vdc		X8L	0.10μF	±10%	GCG21BL81E104KA01#
			0.33μF		±10%	GCG21BL81E334KA01#	
	X8R		39000pF		±10%	GCG21BR91E393KA01#	
			82000pF		±10%	GCG21BR91E823KA01#	
			0.15μF		±10%	GCG21BR91E154KA03#	
			0.18μF		±10%	GCG21BR91E184KA03#	
			0.22μF	±10%	GCG21BR91E224KA03#		
			0.68μF	±10%	GCG21BR91E684KE01#		
			1.0μF	±10%	GCG21BR91E105KE01#		
			X7R	0.27μF	±10%	GCG21BR71E274KA01#	
				0.33μF	±10%	GCG21BR71E334KA01#	
	0.39μF			±10%	GCG21BR71E394KA01#		
	0.47μF			±10%	GCG21BR71E474KA01#		
	0.56μF			±10%	GCG21BR71E564KA01#		
	0.68μF			±10%	GCG21BR71E684KA01#		
	16Vdc	X8L	0.27μF	±10%	GCG21BR71E274KA01#		
			1.0μF	±10%	GCG21BR71E105KA12#		
			0.33μF	±10%	GCG21BL81C334KA01#		
			0.39μF	±10%	GCG21BL81C394KA01#		
			0.47μF	±10%	GCG21BL81C474KA01#		
			0.56μF	±10%	GCG21BL81C564KA01#		
			0.68μF	±10%	GCG21BL81C684KA01#		
			0.82μF	±10%	GCG21BL81C824KA01#		

Part number # indicates the package specification code.

GRT Series
 GCM Series
 GC3 Series
 GCG Series
 GCD Series
 GCE Series
 NMF Series
 KCM Series
 KC3 Series
 KCA Series
 GCG Series
 ⚠Caution / Notice

GRT Series

GCM Series

GC3 Series

GCG Series

GCD Series

GCE Series

NMF Series

KCM Series

KC3 Series

KCA Series

GCG Series

⚠Caution/
 Notice

GCG Series High Dielectric Constant Type Part Number List

(→ 2.0×1.25mm)

T max.	Rated Voltage	TC Code	Cap.	Tol.	Part Number
1.45mm	16Vdc	X7R	4.7μF	±10%	GCG21BR71C475KA12#
	10Vdc	X7R	10μF	±10%	GCG21BR71A106KE01#
	6.3Vdc	X8L	10μF	±10%	GCG21BL8EC106KE07#
		X7R	10μF	±10%	GCG21BR70J106KE01#

3.2×1.6mm

T max.	Rated Voltage	TC Code	Cap.	Tol.	Part Number	
1.35mm	50Vdc	X8R	0.22μF	±10%	GCG31MR91H224KA03#	
			0.33μF	±10%	GCG31MR91H334KA03#	
		25Vdc	X8R	0.15μF	±10%	GCG31MR91E154KA01#
				0.22μF	±10%	GCG31MR91E224KA01#
	X7R		0.33μF	±10%	GCG31MR91E334KA01#	
			1.0μF	±10%	GCG31MR71E105KA01#	
	16Vdc	X8L	1.2μF	±10%	GCG31MR71E125KA01#	
			1.5μF	±10%	GCG31MR71E155KA01#	
			2.2μF	±10%	GCG31MR71E225KA12#	
			1.0μF	±10%	GCG31ML81C105KA01#	
		X7R	1.5μF	±10%	GCG31ML81C155KA01#	
			0.68μF	±10%	GCG31CR91E684KA03#	
3.3μF			±10%	GCG31CR71E335KA01#		
3.9μF			±10%	GCG31CR71E395KA01#		
1.9mm	25Vdc	X8R	4.7μF	±10%	GCG31CR71E475KA01#	
			3.3μF	±10%	GCG31CL81C335KA01#	
		X8L	4.7μF	±10%	GCG31CL81C475KA01#	
			0.68μF	±10%	GCG31CR91C684KA01#	
	X8R	1.0μF	±10%	GCG31CR91C105KA01#		
		22μF	±10%	GCG31CR70J226KE01#		

3.2×2.5mm

T max.	Rated Voltage	TC Code	Cap.	Tol.	Part Number
2.3mm	25Vdc	X7R	3.3μF	±10%	GCG32DR71E335KA01#
2.8mm	50Vdc	X8L	10μF	±10%	GCG32EL8EH106KA07#
		X7S	10μF	±10%	GCG32EC71H106KA01#
	35Vdc	X8L	10μF	±10%	GCG32EL8EG106KA07#
		X7S	10μF	±10%	GCG32EC7YA106KA01#
	25Vdc	X7R	4.7μF	±10%	GCG32ER71E475KA01#
			10μF	±10%	GCG32ER71E106KA12#
	16Vdc	X8R	6.8μF	±10%	GCG32ER91C685KE01#
			10μF	±10%	GCG32ER91C106KE01#
	6.3Vdc	X7R	47μF	±10%	GCG32ER70J476KE01#

**GRT, GCM, GC3, GCJ, GCD, GCE,
 NFM, KCM, KC3, KCA, GCG**

⚠Caution/Notice



⚠Caution

Notice

Storage and Operation Conditions 66

Rating 66

 1. Temperature Dependent Characteristics 66

 2. Measurement of Capacitance 66

 3. Applied Voltage and Applied Current 67

 4. Type of Applied Voltage and Self-heating Temperature 67

 5. DC Voltage and AC Voltage Characteristics 69

 6. Capacitance Aging 69

 7. Vibration and Shock 70

Soldering and Mounting 70

 1. Mounting Position 70

 2. Information before Mounting 71

 3. Maintenance of the Mounting (pick and place) Machine 71

 4-1. Reflow Soldering 72

 4-2. Flow Soldering 73

 4-3. Correction of Soldered Portion 74

 5. Washing 75

 6. Electrical Test on Printed Circuit Board 75

 7. Printed Circuit Board Cropping 75

 8. Assembly 78

 9. Selection of Conductive Adhesive, Mounting Process, and Bonding Strength 79

 10. Moisture Proof Process 79

 11. Application 79

Other 79

 1. Under Operation of Equipment 79

 2. Other 79

Rating 80

 1. Operating Temperature 80

 2. Atmosphere Surroundings (gaseous and liquid) 80

 3. Piezo-electric Phenomenon 80

Soldering and Mounting 80

 1. PCB Design 80

 1. Notice for Pattern Forms 80

 2. Land Dimensions 81

 3. Board Design 83

 2. Adhesive Application 83

 3. Adhesive Curing 84

 4. Flux for Flow Soldering 84

 5. Flow Soldering 84

 6. Reflow Soldering 84

 7. Washing 85

 8. Coating 85

Other 85

 1. Transportation 85

 2. Characteristics Evaluation in the Actual System 85

GRT Series

GCM Series

GC3 Series

GCJ Series

GCD Series

GCE Series

NFM Series

KCM Series

KC3 Series

KCA Series

GCG Series

⚠Caution / Notice

GRT Series
 GCM Series
 GC3 Series
 GCJ Series
 GCD Series
 GCE Series
 NMF Series
 KCM Series
 KC3 Series
 KCA Series
 GCG Series
 ⚠Caution

⚠Caution

Storage and Operation Conditions

1. The performance of chip multilayer ceramic capacitors and chip EMIFIL[®] NFM series (henceforth just “capacitors”) may be affected by the storage conditions.
 - 1-1. Store the capacitors in the following conditions:
 Room Temperature of +5°C to +40°C and a Relative Humidity of 20% to 70%.
 - (1) High temperature and humidity conditions may accelerate the deterioration of solderability due to oxidation of the terminal electrodes and deterioration of taping/packaging performance. Therefore, maintain the appropriate storage temperature and humidity.
 - (2) Prolonged storage may cause oxidation of the electrodes and deterioration of the packaging materials. If more than six months have elapsed since delivery, check the mounting before use. If more than one year has elapsed since delivery, also check the solderability before use.
 - (3) Store the capacitors in the original packaging without opening the smallest packing unit. Do not exceed the above atmospheric conditions for any length of time.
 - 1-2. Corrosive gas can react with the termination (external) electrodes or lead wires of capacitors, and result in poor solderability. Do not store the capacitors in an atmosphere consisting of corrosive gas (e.g., hydrogen sulfide, sulfur dioxide, chlorine, ammonia gas, etc.).
 - 1-3. Due to moisture condensation caused by rapid humidity changes, or the photochemical change caused by direct sunlight on the terminal electrodes and/or the resin/epoxy coatings, the solderability and electrical performance may deteriorate. Do not store capacitors under direct sunlight or in high humidity conditions.
- <Applicable to GCG Series>**
- 1-4. After unpacking, immediately reseal, or store in a desiccator containing a desiccant.

Rating

1. Temperature Dependent Characteristics

1. The electrical characteristics of a capacitor can change with temperature.
 - 1-1. For capacitors having larger temperature dependency, the capacitance may change with temperature changes.
 The following actions are recommended in order to ensure suitable capacitance values.
 - (1) Select a suitable capacitance for the operating temperature range.
 - (2) The capacitance may change within the rated temperature.
 When you use a high dielectric constant type capacitor in a circuit that needs a tight (narrow) capacitance tolerance (e.g., a time-constant circuit), please carefully consider the temperature characteristics, and carefully confirm the various characteristics in actual use conditions and the actual system.

[Example of Temperature Characteristics X7R(R7)]

Sample: 0.1μF, Rated Voltage 50VDC

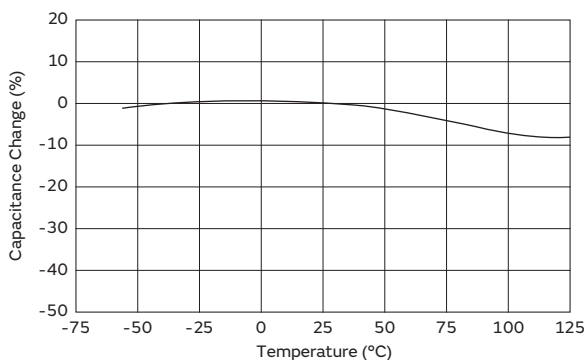

[Example of Temperature Characteristics X5R (R6)]

Sample: 22μF, Rated Voltage 4VDC

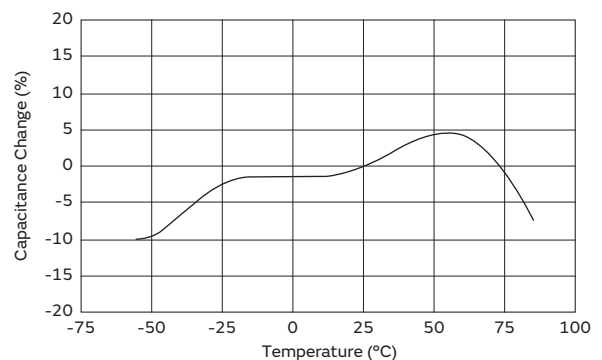

2. Measurement of Capacitance

1. Measure capacitance with the voltage and frequency specified in the product specifications.
 - 1-1. The output voltage of the measuring equipment may decrease occasionally when capacitance is high. Please confirm whether a prescribed measured voltage is impressed to the capacitor.
 - 1-2. The capacitance values of high dielectric constant type capacitors change depending on the AC voltage applied. Please consider the AC voltage characteristics when selecting a capacitor to be used in an AC circuit.

Continued on the following page. ↗

⚠Caution

Continued from the preceding page. ↘

3. Applied Voltage and Applied Current

1. Do not apply a voltage to the capacitor that exceeds the rated voltage as called out in the specifications.
 - 1-1. Applied voltage between the terminals of a capacitor shall be less than or equal to the rated voltage.
 - (1) When AC voltage is superimposed on DC voltage, the zero-to-peak voltage shall not exceed the rated DC voltage.
 When AC voltage or pulse voltage is applied, the peak-to-peak voltage shall not exceed the rated DC voltage.
 - (2) Abnormal voltages (surge voltage, static electricity, pulse voltage, etc.) shall not exceed the rated DC voltage.

Typical Voltage Applied to the DC Capacitor

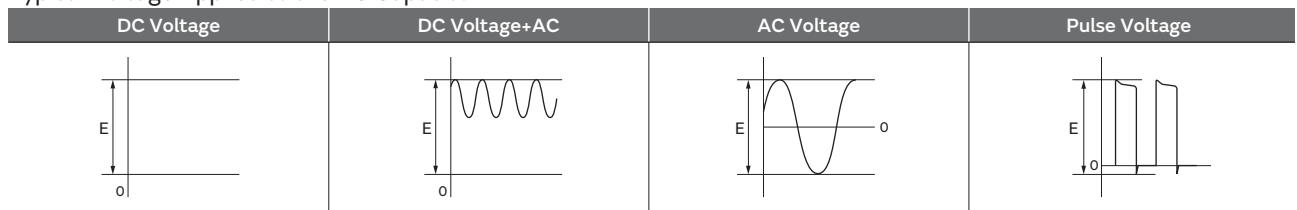

(E: Maximum possible applied voltage.)

- 1-2. Influence of over voltage
 Over voltage that is applied to the capacitor may result in an electrical short circuit caused by the breakdown of the internal dielectric layers. The time duration until breakdown depends on the applied voltage and the ambient temperature.
2. Use a safety standard certified capacitor in a power supply input circuit (AC filter), as it is also necessary to consider the withstand voltage and impulse withstand voltage defined for each device.

<Applicable to NFM Series>

3. The capacitors also have rated currents.
 The current flowing between the terminals of a capacitor shall be less than or equal to the rated current. Using the capacitor beyond this range could lead to excessive heat.

4. Type of Applied Voltage and Self-heating Temperature

1. Confirm the operating conditions to make sure that no large current is flowing into the capacitor due to the continuous application of an AC voltage or pulse voltage.
 When a DC rated voltage product is used in an AC voltage circuit or a pulse voltage circuit, the AC current or pulse current will flow into the capacitor; therefore check the self-heating condition.
 Please confirm the surface temperature of the capacitor so that the temperature remains within the upper limits of the operating temperature, including the rise in temperature due to self-heating. When the capacitor is used with a high-frequency voltage or pulse voltage, heat may be generated by dielectric loss.

<Applicable to Rated Voltage of less than 100VDC>

- 1-1. The load should be contained so that the self-heating of the capacitor body remains below 20°C, when measuring at an ambient temperature of 25°C.

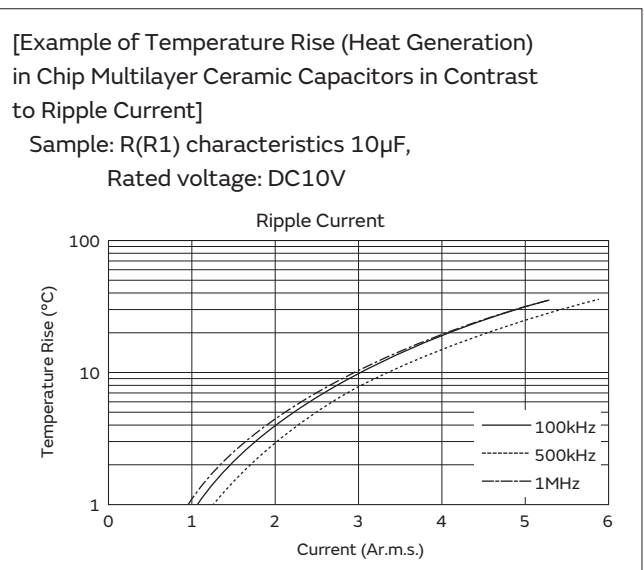

Continued on the following page. ↗

GRT Series
 GCM Series
 GC3 Series
 GCJ Series
 GCD Series
 GCE Series
 NMF Series
 KCM Series
 KC3 Series
 KCA Series
 GCG Series
 ⚠Caution

⚠Caution

Continued from the preceding page. ↘

<Applicable to Temperature Characteristics X7R(R7), X7T(D7) beyond Rated Voltage of 250VDC>

1-2. The load should be contained so that the self-heating of the capacitor body remains below 20°C, when measuring at an ambient temperature of 25°C. In addition, use a K thermocouple of $\varnothing 0.1\text{mm}$ with less heat capacity when measuring, and measure in a condition where there is no effect from the radiant heat of other components or air flow caused by convection. Excessive generation of heat may cause deterioration of the characteristics and reliability of the capacitor. (Absolutely do not perform measurements while the cooling fan is operating, as an accurate measurement may not be performed.)

<Applicable to Temperature Characteristics U2J(7U), COG(5C) beyond Rated Voltage of 250VDC>

1-3. Since the self-heating is low in the low loss series, the allowable power becomes extremely high compared to the common X7R(R7) characteristics. However, when a load with self-heating of 20°C is applied at the rated voltage, the allowable power may be exceeded. When the capacitor is used in a high-frequency voltage circuit of 1kHz or more, the frequency of the applied voltage should be less than 500kHz sine wave (less than 100kHz for a product with rated voltage of DC3.15kV), to limit the voltage load so that the load remains within the derating shown in the following figure. In the case of non-sine wave, high-frequency components exceeding the fundamental frequency may be included. In such a case, please contact Murata. The excessive generation of heat may cause deterioration of the characteristics and reliability of the capacitor. (Absolutely do not perform measurements while the cooling fan is operating, as an accurate measurement may not be performed.)

[Sine-wave frequency VS allowable voltage]

The surface temperature of the capacitor: 125°C or less (including self-heating)

COG (5C) char., Rated Voltage: DC250V
 1206/3216 (in inch/mm) size

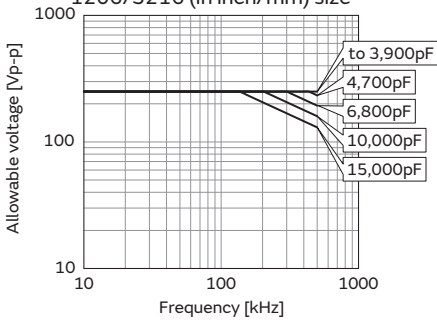

COG char., Rated Voltage: DC630V

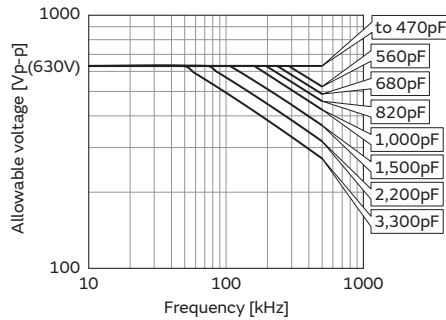

COG char., Rated Voltage: DC1kV

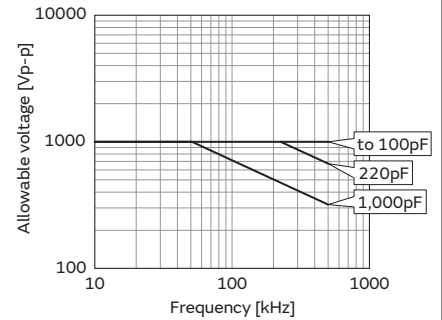

U2J(7U) char., Rated Voltage: DC250V

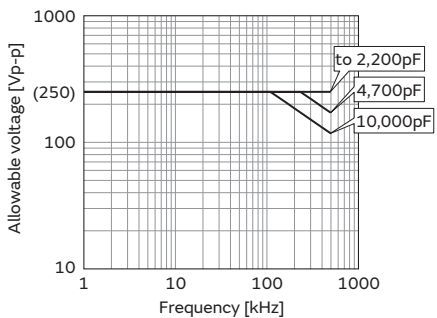

U2J(7U) char., Rated Voltage: DC630V

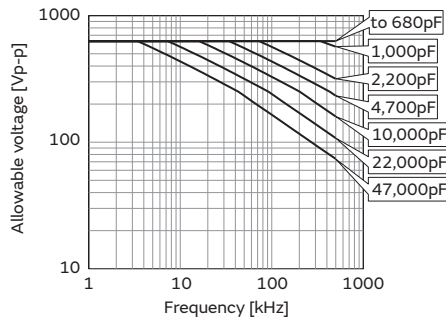

U2J(7U) char., Rated Voltage: DC1kV

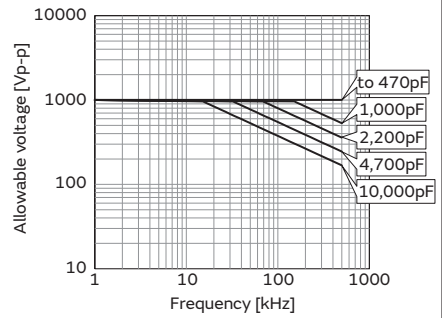

Continued on the following page. ↗



Continued from the preceding page. ↘

5. DC Voltage and AC Voltage Characteristics

1. The capacitance value of a high dielectric constant type capacitor changes depending on the DC voltage applied. Please consider the DC voltage characteristics when a capacitor is selected for use in a DC circuit.

1-1. The capacitance of ceramic capacitors may change sharply depending on the applied voltage (see figure). Please confirm the following in order to secure the capacitance.

- (1) Determine whether the capacitance change caused by the applied voltage is within the allowed range.
- (2) In the DC voltage characteristics, the rate of capacitance change becomes larger as voltage increases, even if the applied voltage is below the rated voltage. When a high dielectric constant type capacitor is used in a circuit that requires a tight (narrow) capacitance tolerance (e.g., a time constant circuit), please carefully consider the voltage characteristics, and confirm the various characteristics in the actual operating conditions of the system.

2. The capacitance values of high dielectric constant type capacitors changes depending on the AC voltage applied. Please consider the AC voltage characteristics when selecting a capacitor to be used in an AC circuit.

[Example of DC Voltage Characteristics]

Sample: R(R1) Characteristics 0.1 μ F,
 Rated Voltage 50VDC

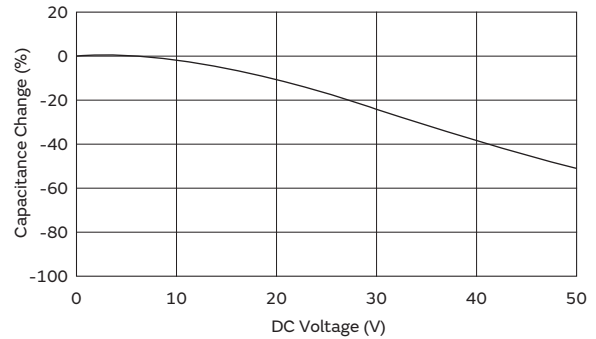

[Example of AC Voltage Characteristics]

Sample: X7R(R7) Characteristics 10 μ F,
 Rated Voltage 6.3VDC

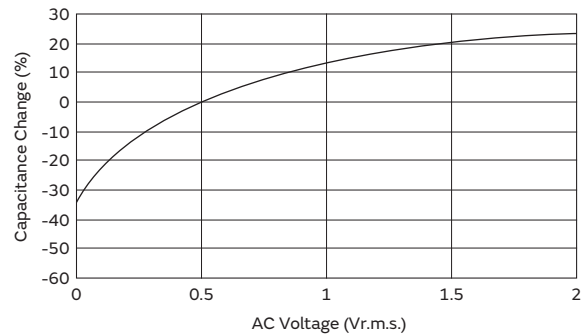

6. Capacitance Aging

1. The high dielectric constant type capacitors have the Characteristics in which the capacitance value decreases with the passage of time.

When you use high dielectric constant type capacitors in a circuit that needs a tight (narrow) capacitance tolerance (e.g., a time-constant circuit), please carefully consider the characteristics of these capacitors, such as their aging, voltage, and temperature characteristics. In addition, check capacitors using your actual appliances at the intended environment and operating conditions.

[Example of Change Over Time (Aging Characteristics)]

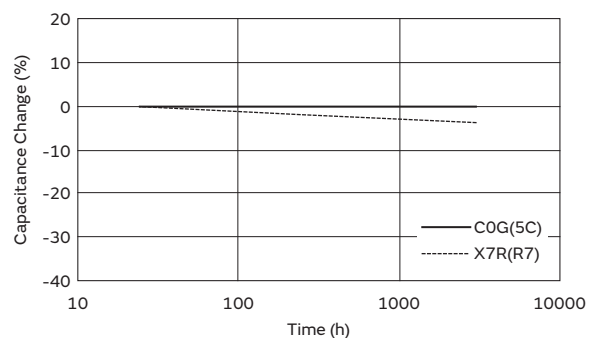

Continued on the following page. ↗

GRT Series

GCM Series

GC3 Series

GCJ Series

GCD Series

GCE Series

NMF Series

KCM Series

KC3 Series

KCA Series

GCG Series

⚠Caution

69

GRT Series
 GCM Series
 GC3 Series
 GCJ Series
 GCD Series
 GCE Series
 NMF Series
 KCM Series
 KC3 Series
 KCA Series
 GCG Series
 ⚠Caution

⚠Caution

Continued from the preceding page. ↘

7. Vibration and Shock

1. Please confirm the kind of vibration and/or shock, its condition, and any generation of resonance.
 Please mount the capacitor so as not to generate resonance, and do not allow any impact on the terminals.
2. Mechanical shock due to being dropped may cause damage or a crack in the dielectric material of the capacitor.
 Do not use a dropped capacitor because the quality and reliability may be deteriorated.
3. When printed circuit boards are piled up or handled, the corner of another printed circuit board should not be allowed to hit the capacitor, in order to avoid a crack or other damage to the capacitor.

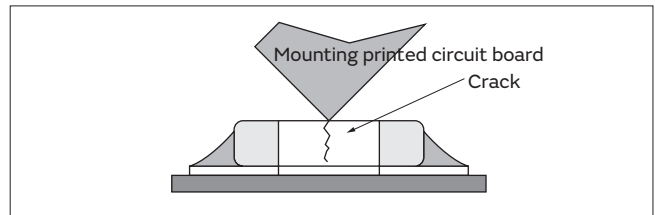
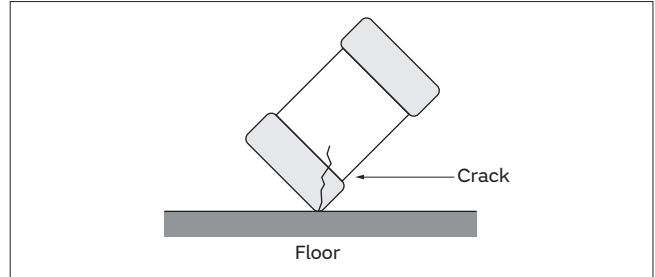

Soldering and Mounting

1. Mounting Position

1. Confirm the best mounting position and direction that minimizes the stress imposed on the capacitor during flexing or bending of the printed circuit board.
 - 1-1. Choose a mounting position that minimizes the stress imposed on the chip during flexing or bending of the board.

<Applicable to NFM Series>

2. If you mount the capacitor near components that generate heat, take note of the heat from the other components and carefully check the self-heating of the capacitor before using.
 If there is significant heat radiation from other components, it could lower the insulation resistance of the capacitor or produce excessive heat.

[Component Direction]

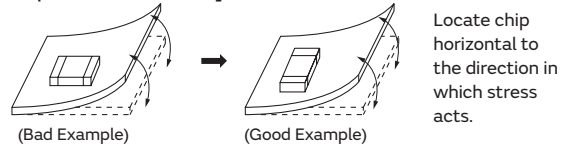

[Chip Mounting Close to Board Separation Point]

It is effective to implement the following measures, to reduce stress in separating the board.
 It is best to implement all of the following three measures; however, implement as many measures as possible to reduce stress.

Contents of Measures	Stress Level
(1) Turn the mounting direction of the component parallel to the board separation surface.	A > D *1
(2) Add slits in the board separation part.	A > B
(3) Keep the mounting position of the component away from the board separation surface.	A > C

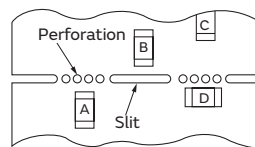

*1 A > D is valid when stress is added vertically to the perforation as with Hand Separation.
 If a Cutting Disc is used, stress will be diagonal to the PCB, therefore A > D is invalid.

[Mounting Capacitors Near Screw Holes]

When a capacitor is mounted near a screw hole, it may be affected by the board deflection that occurs during the tightening of the screw. Mount the capacitor in a position as far away from the screw holes as possible.

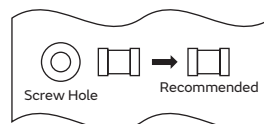

Continued on the following page. ↗

△Caution

Continued from the preceding page. ↘

2. Information before Mounting

1. Do not re-use capacitors that were removed from the equipment.
2. Confirm capacitance characteristics under actual applied voltage.
3. Confirm the mechanical stress under actual process and equipment use.
4. Confirm the rated capacitance, rated voltage and other electrical characteristics before assembly.
5. Prior to use, confirm the solderability of capacitors that were in long-term storage.
6. Prior to measuring capacitance, carry out a heat treatment for capacitors that were in long-term storage.
7. The use of Sn-Zn based solder will deteriorate the reliability of the MLCC.

Please contact our sales representative or product engineers on the use of Sn-Zn based solder in advance.

8. We have also produced a DVD which shows a summary of our recommendations, regarding the precautions for mounting. Please contact our sales representative to request the DVD.

3. Maintenance of the Mounting (pick and place) Machine

1. Make sure that the following excessive forces are not applied to the capacitors. Check the mounting in the actual device under actual use conditions ahead of time.

1-1. In mounting the capacitors on the printed circuit board, any bending force against them shall be kept to a minimum to prevent them from any damage or cracking. Please take into account the following precautions and recommendations for use in your process.

- (1) Adjust the lowest position of the pickup nozzle so as not to bend the printed circuit board.

2. Dirt particles and dust accumulated in the suction nozzle and suction mechanism prevent the nozzle from moving smoothly. This creates excessive force on the capacitor during mounting, causing cracked chips. Also, the locating claw, when worn out, imposes uneven forces on the chip when positioning, causing cracked chips. The suction nozzle and the locating claw must be maintained, checked, and replaced periodically.

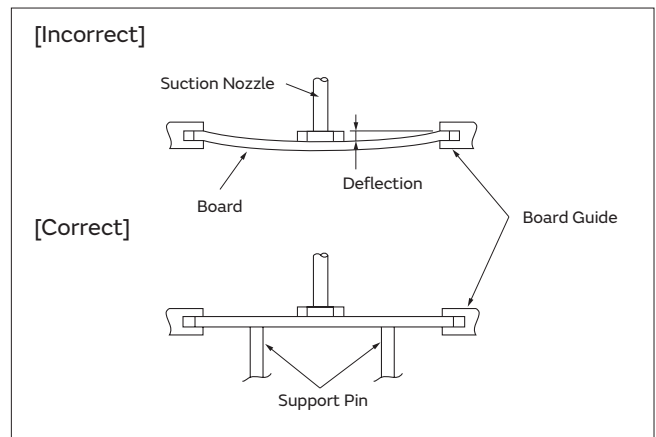

Continued on the following page. ↗

GRT Series

GCM Series

GC3 Series

GCJ Series

GCD Series

GCE Series

NMF Series

KCM Series

KC3 Series

KCA Series

GCG Series

△Caution

71

GRT Series
 GCM Series
 GC3 Series
 GCJ Series
 GCD Series
 GCE Series
 NMF Series
 KCM Series
 KC3 Series
 KCA Series
 GCG Series
 ⚠Caution

⚠Caution

Continued from the preceding page. ↘

4-1. Reflow Soldering

- When sudden heat is applied to the components, the mechanical strength of the components will decrease because a sudden temperature change causes deformation inside the components. In order to prevent mechanical damage to the components, preheating is required for both the components and the PCB. Preheating conditions are shown in table 1. It is required to keep the temperature differential between the solder and the components surface (ΔT) as small as possible.
- When components are immersed in solvent after mounting, be sure to maintain the temperature difference (ΔT) between the component and the solvent within the range shown in table 1.

Table 1

Series	Chip Dimension Code (L/W)	Temperature Differential
GRT/GCM/GC3/GCD/GCE/GCJ/NFM	03/15/18/21/31	$\Delta T \leq 190^\circ\text{C}$
GRT/GCM/GCJ	32/43/55	$\Delta T \leq 130^\circ\text{C}$
KCM/KC3/KCA	55	

Recommended Conditions

	Pb-Sn Solder	Lead Free Solder
Peak Temperature	230 to 250°C	240 to 260°C
Atmosphere	Air	Air or N ₂

Pb-Sn Solder: Sn-37Pb

Lead Free Solder: Sn-3.0Ag-0.5Cu

- When a capacitor is mounted at a temperature lower than the peak reflow temperature recommended by the solder manufacturer, the following quality problems can occur. Consider factors such as the placement of peripheral components and the reflow temperature setting to prevent the capacitor's reflow temperature from dropping below the peak temperature specified. Be sure to evaluate the mounting situation beforehand and verify that none of the following problems occur.
 - Drop in solder wettability
 - Solder voids
 - Possible occurrence of whiskering
 - Drop in bonding strength
 - Drop in self-alignment properties
 - Possible occurrence of tombstones and/or shifting on the land patterns of the circuit board

- Drop in solder wettability
- Solder voids
- Possible occurrence of whiskering
- Drop in bonding strength
- Drop in self-alignment properties
- Possible occurrence of tombstones and/or shifting on the land patterns of the circuit board

4. Optimum Solder Amount for Reflow Soldering

- Overly thick application of solder paste results in a excessive solder fillet height. This makes the chip more susceptible to mechanical and thermal stress on the board and may cause the chips to crack.

[Example of Temperature Conditions for Reflow Soldering]

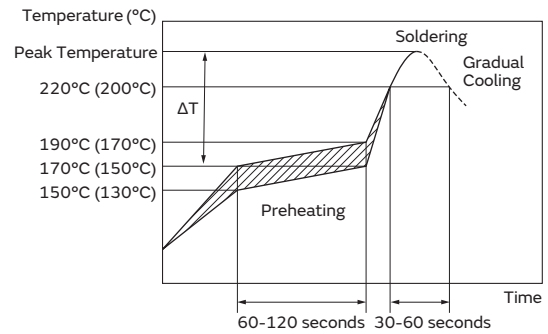

Temperature
 Incase of Lead Free Solder
 (): In case of Pb-Sn Solder

[Allowable Reflow Soldering Temperature and Time]

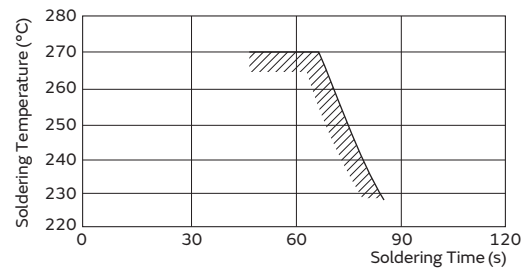

In the case of repeated soldering, the accumulated soldering time must be within the range shown above.

- Too little solder paste results in a lack of adhesive strength on the termination, which may result in chips breaking loose from the PCB.
- Please confirm that solder has been applied smoothly to the termination.

<Applicable to NFM Series>

[Guideline of solder paste thickness]

100-150 μm : NFM21HC/31HK

NFM21HC

NFM31HK

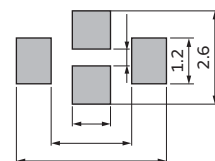
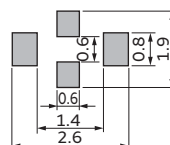

Inverting the PCB

Make sure not to impose any abnormal mechanical shocks to the PCB.

Continued on the following page. ↗



Continued from the preceding page. ↘

4-2. Flow Soldering

1. Do not apply flow soldering to chips not listed in table 2.

Table 2

Series	Chip Dimension Code (L/W)	Temperature Differential
GRT/GCM/GC3/GCD (Except for characteristics of X8L(L8), X8G(5G), CHA(OC), X8R(R9))	18/21/31	$\Delta T \leq 150^\circ\text{C}$
GCJ (Rated Voltage 250VDC or more)		
NFM		

- When sudden heat is applied to the components, the mechanical strength of the components will decrease because a sudden temperature change causes deformation inside the components. In order to prevent mechanical damage to the components, preheating is required for both of the components and the PCB. Preheating conditions are shown in table 2. It is required to keep the temperature differential between the solder and the components surface (ΔT) as low as possible.
- Excessively long soldering time or high soldering temperature can result in leaching of the terminations, causing poor adhesion or a reduction in capacitance value due to loss of contact between the inner electrodes and terminations.
- When components are immersed in solvent after mounting, be sure to maintain the temperature differential (ΔT) between the component and solvent within the range shown in the table 2.

Recommended Conditions

	Pb-Sn Solder	Lead Free Solder
Preheating Peak Temperature	90 to 110°C	100 to 120°C 140 to 160°C (NFM)
Soldering Peak Temperature	240 to 250°C	250 to 260°C
Atmosphere	Air	Air or N ₂

Pb-Sn Solder: Sn-37Pb

Lead Free Solder: Sn-3.0Ag-0.5Cu

5. Optimum Solder Amount for Flow Soldering

- The top of the solder fillet should be lower than the thickness of the components. If the solder amount is excessive, the risk of cracking is higher during board bending or any other stressful condition.

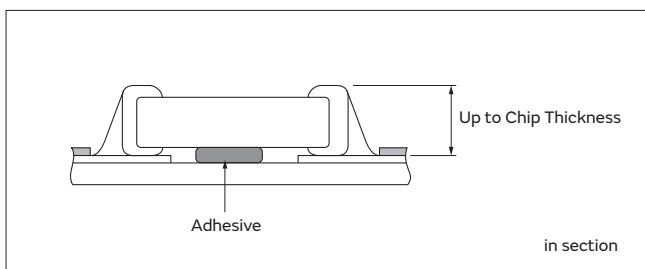

[Example of Temperature Conditions for Flow Soldering]

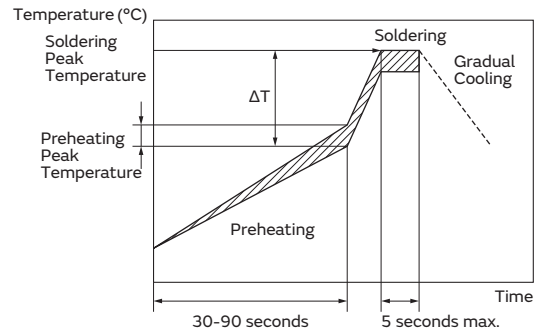

[Allowable Flow Soldering Temperature and Time]

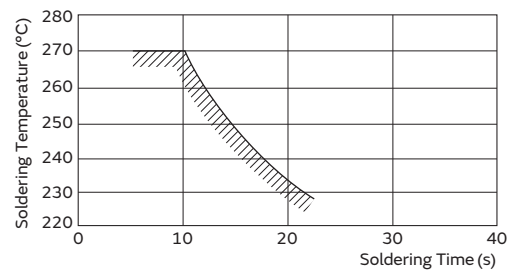

In the case of repeated soldering, the accumulated soldering time must be within the range shown above.

<Applicable to NFM Series>

[NFM31HK Series]

Apply 0.06mg of bonding agent at each chip. Do not cover electrodes.

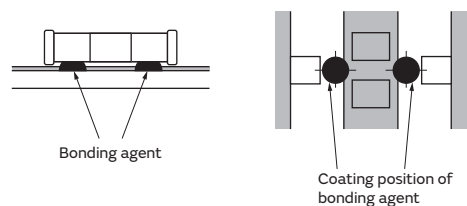

Continued on the following page. ↗

GRT Series
 GCM Series
 GC3 Series
 GCJ Series
 GCD Series
 GCE Series
 NMF Series
 KCM Series
 KC3 Series
 KCA Series
 GCG Series
 ⚠Caution

⚠Caution

Continued from the preceding page. ↘

4-3. Correction of Soldered Portion

When sudden heat is applied to the capacitor, distortion caused by the large temperature difference occurs internally, and can be the cause of cracks. Capacitors also tend to be affected by mechanical and thermal stress depending on the board preheating temperature or the soldering fillet shape, and can be the cause of cracks. Please refer to "1. PCB Design" or "3. Optimum solder amount" for the solder amount and the fillet shapes.

1. Correction with a Soldering Iron

- 1-1. In order to reduce damage to the capacitor, be sure to preheat the capacitor and the mounting board. Preheat to the temperature range shown in Table 3. A hot plate, hot air type preheater, etc. can be used for preheating.

Table 3

Series	Chip Dimension Code (L/W)	Temperature of Soldering Iron Tip	Preheating Temperature	Temperature Differential (ΔT)	Atmosphere
GRT/GCM/GC3/GCD/GCE/GCJ	03/15/18/21/31	350°C max.	150°C min.	$\Delta T \leq 190^\circ\text{C}$	Air
GRT/GCM/GCJ	32/43/55	280°C max.	150°C min.	$\Delta T \leq 130^\circ\text{C}$	Air
NFM	21/31	350°C max.	150°C min.	$\Delta T \leq 190^\circ\text{C}$	Air

*Applicable for both Pb-Sn and Lead Free Solder.

Pb-Sn Solder: Sn-37Pb

Lead Free Solder: Sn-3.0Ag-0.5Cu

*Please manage ΔT in the temperature of soldering iron and the preheating temperature.

2. Correction with Spot Heater

Compared to local heating with a soldering iron, hot air heating by a spot heater heats the overall component and board, therefore, it tends to lessen the thermal shock. In the case of a high density mounted board, a spot heater can also prevent concerns of the soldering iron making direct contact with the component.

- 2-1. If the distance from the hot air outlet of the spot heater to the component is too close, cracks may occur due to thermal shock. To prevent this problem, follow the conditions shown in Table 4.

- 2-2. In order to create an appropriate solder fillet shape, it is recommended that hot air be applied at the angle shown in Figure 1.

3. Optimum solder amount when re-working with a soldering iron

- 3-1. If the solder amount is excessive, the risk of cracking is higher during board bending or any other stressful condition.

Too little solder amount results in a lack of adhesive strength on the outer electrode termination, which may result in chips breaking loose from the PCB. Please confirm that solder has been applied smoothly is and rising to the end surface of the chip.

- 1-2. After soldering, do not allow the component/PCB to cool down rapidly.
 1-3. Perform the corrections with a soldering iron as quickly as possible. If the soldering iron is applied too long, there is a possibility of causing solder leaching on the terminal electrodes, which will cause deterioration of the adhesive strength and other problems.

Table 4

Distance	5mm or more
Hot Air Application Angle	45° *Figure 1
Hot Air Temperature Nozzle Outlet	400°C max.
Application Time	Less than 10 seconds (1206 (3216 in mm) size or smaller)
	Less than 30 seconds (1210 (3225 in mm) size or larger)

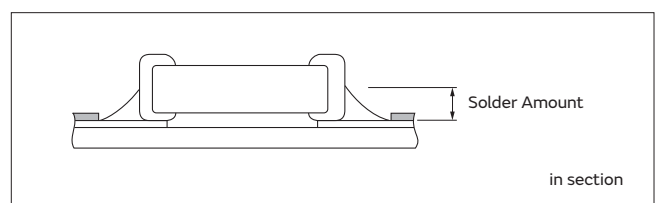
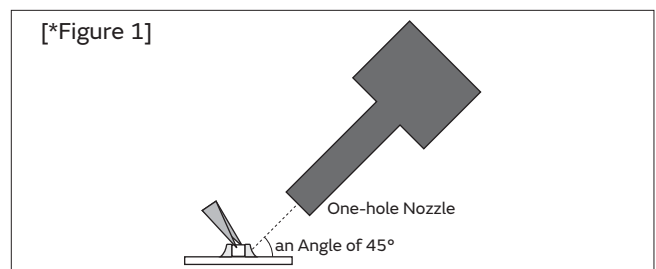

Continued on the following page. ↗

Caution

Continued from the preceding page. ↘

- 3-2. A soldering iron with a tip of $\phi 3\text{mm}$ or smaller should be used. It is also necessary to keep the soldering iron from touching the components during the re-work.
- 3-3. Solder wire with $\phi 0.5\text{mm}$ or smaller is required for soldering.

<Applicable to KCM/KC3/KCA Series>

4. For the shape of the soldering iron tip, refer to the figure on the right.

Regarding the type of solder, use a wire diameter of $\phi 0.5\text{mm}$ or less (rosin core wire solder).

4-1. How to Apply the Soldering Iron

Apply the tip of the soldering iron against the lower end of the metal terminal.

- 1) In order to prevent cracking caused by sudden heating of the ceramic device, do not touch the ceramic base directly.
- 2) In order to prevent deviations and dislocating of the chip, do not touch the junction of the chip and the metal terminal, and the metal portion on the outside directly.

4-2. Appropriate Amount of Solder

The amount of solder for corrections by soldering iron, should be lower than the height of the lower side of the chip.

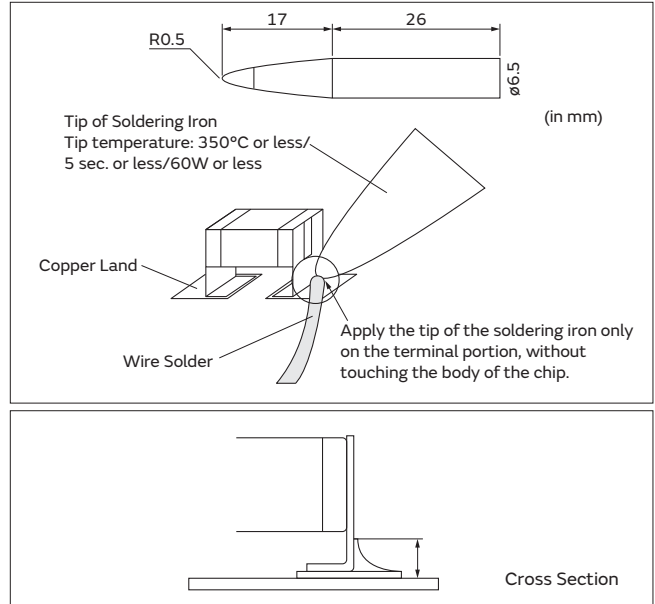

5. Washing

Excessive ultrasonic oscillation during cleaning can cause the PCBs to resonate, resulting in cracked chips or broken solder joints. Before starting your production process, test your cleaning equipment/process to insure it does not degrade the capacitors.

6. Electrical Test on Printed Circuit Board

1. Confirm position of the support pin or specific jig, when inspecting the electrical performance of a capacitor after mounting on the printed circuit board.

1-1. Avoid bending the printed circuit board by the pressure of a test-probe, etc.

The thrusting force of the test probe can flex the PCB, resulting in cracked chips or open solder joints. Provide support pins on the back side of the PCB to prevent warping or flexing. Install support pins as close to the test-probe as possible.

1-2. Avoid vibration of the board by shock when a test-probe contacts a printed circuit board.

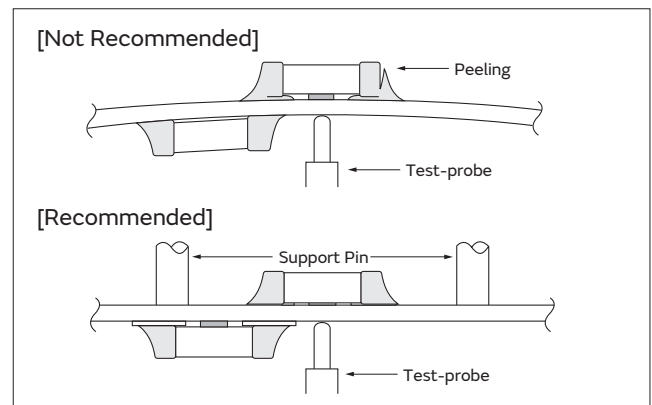

7. Printed Circuit Board Cropping

1. After mounting a capacitor on a printed circuit board, do not apply any stress to the capacitor that causes bending or twisting the board.

- 1-1. In cropping the board, the stress as shown at right may cause the capacitor to crack. Avoid this type of stress to a capacitor.

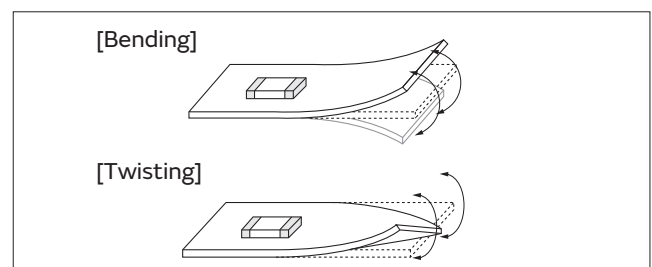

Continued on the following page. ↗

GRT Series

GCM Series

GC3 Series

GCC Series

GCD Series

GCE Series

NMF Series

KCM Series

KC3 Series

KCA Series

GCG Series

Caution

75

GRT Series
 GCM Series
 GC3 Series
 GCJ Series
 GCD Series
 GCE Series
 NMF Series
 KCM Series
 KC3 Series
 KCA Series
 GCG Series
 ⚠Caution

⚠Caution

Continued from the preceding page. ↘

2. Check the cropping method for the printed circuit board in advance.

2-1. Printed circuit board cropping shall be carried out by using a jig or an apparatus (Disc separator, router type separator, etc.) to prevent the mechanical stress that can occur to the board.

Board Separation Method	Hand Separation Nipper Separation	(1) Board Separation Jig	Board Separation Apparatus	
			(2) Disc Separator	(3) Router Type Separator
Level of stress on board	High	Medium	Medium	Low
Recommended	×	△*	△*	○
Notes	Hand and nipper separation apply a high level of stress. Use another method.	<ul style="list-style-type: none"> · Board handling · Board bending direction · Layout of capacitors 	<ul style="list-style-type: none"> · Board handling · Layout of slits · Design of V groove · Arrangement of blades · Controlling blade life 	Board handling

* When a board separation jig or disc separator is used, if the following precautions are not observed, a large board deflection stress will occur and the capacitors may crack. Use router type separator if at all possible.

(1) Example of a suitable jig

[In the case of Single-side Mounting]

An outline of the board separation jig is shown as follows. Recommended example: Stress on the component mounting position can be minimized by holding the portion close to the jig, and bend in the direction towards the side where the capacitors are mounted. Not recommended example: The risk of cracks occurring in the capacitors increases due to large stress being applied to the component mounting position, if the portion away from the jig is held and bent in the direction opposite the side where the capacitors are mounted.

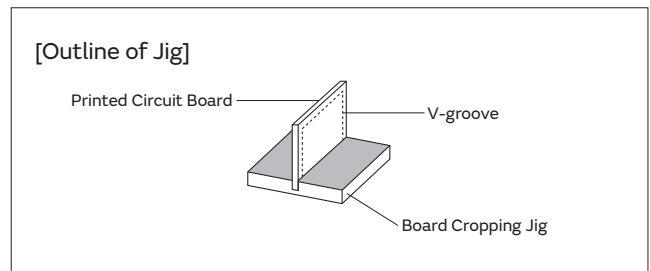

Hand Separation

Recommended	Not Recommended

[In the case of Double-sided Mounting]

Since components are mounted on both sides of the board, the risk of cracks occurring can not be avoided with the above method. Therefore, implement the following measures to prevent stress from being applied to the components.

(Measures)

- (1) Consider introducing a router type separator. If it is difficult to introduce a router type separator, implement the following measures. (Refer to item 1. Mounting Position)
- (2) Mount the components parallel to the board separation surface.
- (3) When mounting components near the board separation point, add slits in the separation position near the component.
- (4) Keep the mounting position of the components away from the board separation point.

Continued on the following page. ↗



Continued from the preceding page. ↘

(2) Example of a Disc Separator

An outline of a disc separator is shown as follows. As shown in the Principle of Operation, the top blade and bottom blade are aligned with the V-grooves on the printed circuit board to separate the board.

In the following case, board deflection stress will be applied and cause cracks in the capacitors.

- (1) When the adjustment of the top and bottom blades are misaligned, such as deviating in the top-bottom, left-right or front-rear directions
- (2) The angle of the V groove is too low, depth of the V groove is too shallow, or the V groove is misaligned top-bottom

IF V groove is too deep, it is possible to brake when you handle and carry it. Carefully design depth of the V groove with consideration about strength of material of the printed circuit board.

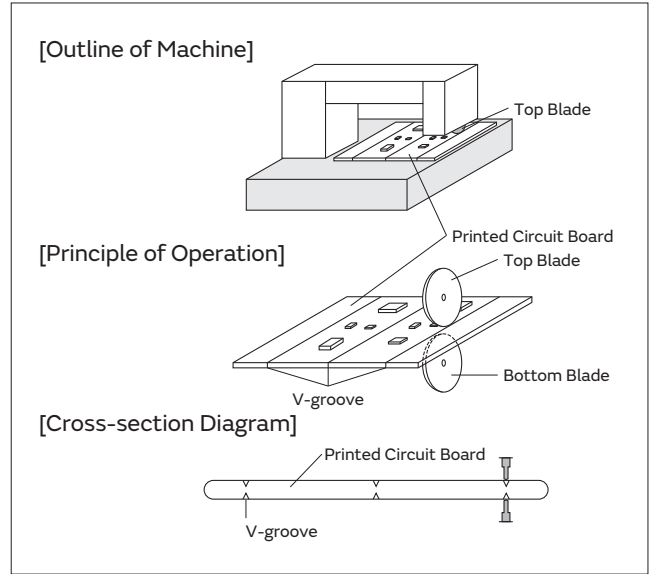

Disc Separator

Recommended	Not Recommended		
	Top-bottom Misalignment	Left-right Misalignment	Front-rear Misalignment
<p>Top Blade</p> <p>Bottom Blade</p>	<p>Top Blade</p> <p>Bottom Blade</p>	<p>Top Blade</p> <p>Bottom Blade</p>	<p>Top Blade</p> <p>Bottom Blade</p>

V-groove Design

Example of Recommended V-groove Design	Not Recommended			
	Left-right Misalignment	Low-Angle	Depth too Shallow	Depth too Deep

(3) Example of Router Type Separator

The router type separator performs cutting by a router rotating at a high speed. Since the board does not bend in the cutting process, stress on the board can be suppressed during board separation.

When attaching or removing boards to/from the router type separator, carefully handle the boards to prevent bending.

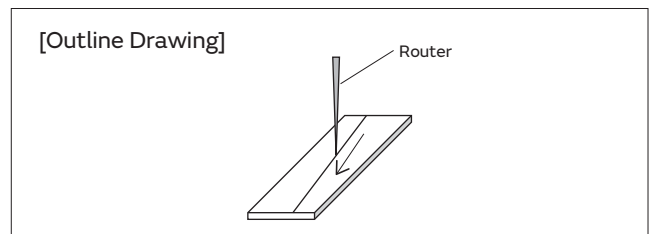

Continued on the following page. ↗

GRT Series
 GCM Series
 GC3 Series
 GCJ Series
 GCD Series
 GCE Series
 NMF Series
 KCM Series
 KC3 Series
 KCA Series
 GCG Series



⚠Caution

Continued from the preceding page. ↘

8. Assembly

1. Handling

If a board mounted with capacitors is held with one hand, the board may bend. Firmly hold the edges of the board with both hands when handling.

If a board mounted with capacitors is dropped, cracks may occur in the capacitors.

Do not use dropped boards, as there is a possibility that the quality of the capacitors may be impaired.

2. Attachment of Other Components

2-1. Mounting of Other Components

Pay attention to the following items, when mounting other components on the back side of the board after capacitors have been mounted on the opposite side. When the bottom dead point of the suction nozzle is set too low, board deflection stress may be applied to the capacitors on the back side (bottom side), and cracks may occur in the capacitors.

· After the board is straightened, set the bottom dead point of the nozzle on the upper surface of the board.

· Periodically check and adjust the bottom dead point.

2-2. Inserting Components with Leads into Boards

When inserting components (transformers, IC, etc.) into boards, bending the board may cause cracks in the capacitors or cracks in the solder.

Pay attention to the following.

· Increase the size of the holes to insert the leads, to reduce the stress on the board during insertion.

· Fix the board with support pins or a dedicated jig before insertion.

· Support below the board so that the board does not bend. When using support pins on the board, periodically confirm that there is no difference in the height of each support pin.

2-3. Attaching/Removing Sockets and/or Connectors

Insertion and removal of sockets and connectors, etc., might cause the board to bend. Please insure that the board does not warp during insertion and removal of sockets and connectors, etc., or the bending may damage mounted components on the board.

2-4. Tightening Screws

The board may be bent, when tightening screws, etc. during the attachment of the board to a shield or chassis.

Pay attention to the following items before performing the work.

· Plan the work to prevent the board from bending.

· Use a torque screwdriver, to prevent over-tightening of the screws.

· The board may bend after mounting by reflow soldering, etc. Please note, as stress may be applied to the chips by forcibly flattening the board when tightening the screws.

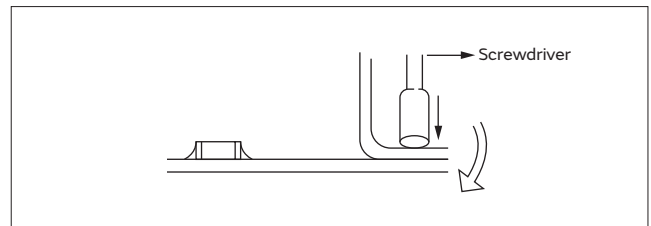
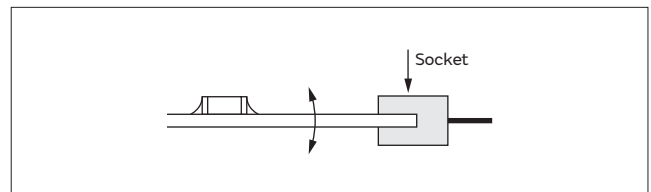
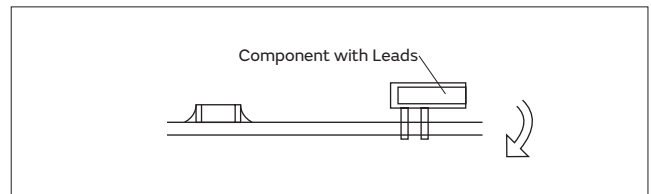
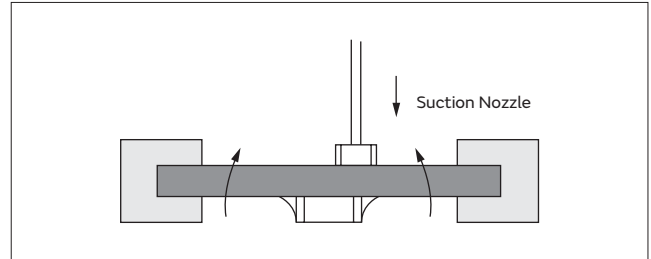

Continued on the following page. ↗



Continued from the preceding page. ↘

<Applicable to GCG Series>

9. Selection of Conductive Adhesive, Mounting Process, and Bonding Strength

The acquired bonding strength may change greatly depending on the conductive adhesive to be used.

Be sure to confirm if the desired performance can be acquired in the assumed mounting process with the conductive adhesive to be used.

10. Moisture Proof Process

In order to prevent the occurrence of migration, perform a moisture proof process, such as applying a resin coating or enclosing with a dry inert gas.

11. Application

This product is limited to conductive glue mounting. When performing solder mounting, contact Murata in advance.

Other

1. Under Operation of Equipment

- 1-1. Do not touch a capacitor directly with bare hands during operation in order to avoid the danger of an electric shock.
- 1-2. Do not allow the terminals of a capacitor to come in contact with any conductive objects (short-circuit). Do not expose a capacitor to a conductive liquid, including any acid or alkali solutions.
- 1-3. Confirm the environment in which the equipment will operate is under the specified conditions. Do not use the equipment under the following environments.
 - (1) Being splattered with water or oil.
 - (2) Being exposed to direct sunlight.
 - (3) Being exposed to ozone, ultraviolet rays, or radiation.
 - (4) Being exposed to toxic gas (e.g., hydrogen sulfide, sulfur dioxide, chlorine, ammonia gas, etc.)
 - (5) Any vibrations or mechanical shocks exceeding the specified limits.
 - (6) Moisture condensing environments.
- 1-4. Use damp proof countermeasures if using under any conditions that can cause condensation.

2. Other

- 2-1. In an Emergency
 - (1) If the equipment should generate smoke, fire, or smell, immediately turn off or unplug the equipment. If the equipment is not turned off or unplugged, the hazards may be worsened by supplying continuous power.
 - (2) In this type of situation, do not allow face and hands to come in contact with the capacitor or burns may be caused by the capacitor's high temperature.

2-2. Disposal of Waste

When capacitors are disposed of, they must be burned or buried by an industrial waste vendor with the appropriate licenses.

2-3. Circuit Design

- (1) Addition of Fail Safe Function
Capacitors that are cracked by dropping or bending of the board may cause deterioration of the insulation resistance, and result in a short. If the circuit being used may cause an electrical shock, smoke or fire when a capacitor is shorted, be sure to install fail-safe functions, such as a fuse, to prevent secondary accidents.
- (2) Capacitors used to prevent electromagnetic interference in the primary AC side circuit, or as a connection/insulation, must be a safety standard certified product, or satisfy the contents stipulated in the Electrical Appliance and Material Safety Law. Install a fuse for each line in case of a short.
- (3) The GC3, GCD, GCE, GCG, GCJ, GCM, KC3, and KCM series are not safety standard certified products.

2-4. Remarks

Failure to follow the cautions may result, worst case, in a short circuit and smoking when the product is used.

The above notices are for standard applications and conditions. Contact us when the products are used in special mounting conditions.

Select optimum conditions for operation as they determine the reliability of the product after assembly.

The data herein are given in typical values, not guaranteed ratings.

GRT Series

GCM Series

GC3 Series

GCJ Series

GCD Series

GCE Series

NMF Series

KCM Series

KC3 Series

KCA Series

GCG Series

⚠Caution

Notice

Rating

1. Operating Temperature

1. The operating temperature limit depends on the capacitor.
 - 1-1. Do not apply temperatures exceeding the upper operating temperature.
It is necessary to select a capacitor with a suitable rated temperature that will cover the operating temperature range.
It is also necessary to consider the temperature distribution in equipment and the seasonal temperature variable factor.
 - 1-2. Consider the self-heating factor of the capacitor.
The surface temperature of the capacitor shall not exceed the maximum operating temperature including self-heating.

2. Atmosphere Surroundings (gaseous and liquid)

1. Restriction on the operating environment of capacitors.
 - 1-1. Capacitors, when used in the above, unsuitable, operating environments may deteriorate due to the corrosion of the terminations and the penetration of moisture into the capacitor.
 - 1-2. The same phenomenon as the above may occur when the electrodes or terminals of the capacitor are subject to moisture condensation.
 - 1-3. The deterioration of characteristics and insulation resistance due to the oxidization or corrosion of terminal electrodes may result in breakdown when the capacitor is exposed to corrosive or volatile gases or solvents for long periods of time.

3. Piezo-electric Phenomenon

1. When using high dielectric constant type capacitors in AC or pulse circuits, the capacitor itself vibrates at specific frequencies and noise may be generated.
Moreover, when the mechanical vibration or shock is added to the capacitor, noise may occur.

Soldering and Mounting

1. PCB Design

1. Notice for Pattern Forms
 - 1-1. Unlike leaded components, chip components are susceptible to flexing stresses since they are mounted directly on the substrate.
They are also more sensitive to mechanical and thermal stresses than leaded components.
Excess solder fillet height can multiply these stresses and cause chip cracking. When designing substrates, take land patterns and dimensions into consideration to eliminate the possibility of excess solder fillet height.
 - 1-2. There is a possibility of chip cracking caused by PCB expansion/contraction with heat, because stress on a chip is different depending on PCB material and structure. When the thermal expansion coefficient greatly differs between the board used for mounting and the chip, it will cause cracking of the chip due to the thermal expansion and contraction. When capacitors are mounted on a fluorine resin printed circuit board or on a single-layered glass epoxy board, it may also cause cracking of the chip for the same reason.

<Applicable to NFM Series>



- 1-3. Because noise is suppressed by shunting unwanted high-frequency components to the ground, when designing a land for the NFM series, design the ground pattern to be as large as possible in order to better bring out this characteristic.
As shown in the figure below, noise countermeasures can be made more effective by using a via to connect the ground pattern on the chip mounting surface to a larger ground pattern on the inner layer.

Continued on the following page. ↗

Notice

Continued from the preceding page. ↘

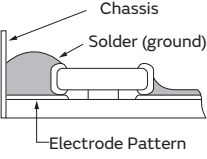
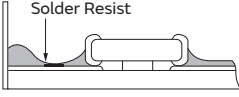
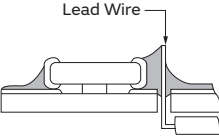
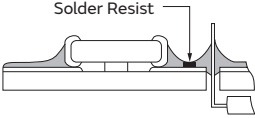
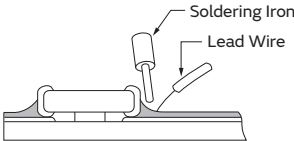
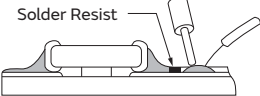
Pattern Forms

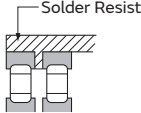
	Prohibited	Correct
Placing Close to Chassis	 <p style="text-align: right;">in section</p>	 <p style="text-align: right;">in section</p>
Placing of Chip Components and Leaded Components	 <p style="text-align: right;">in section</p>	 <p style="text-align: right;">in section</p>
Placing of Leaded Components after Chip Component	 <p style="text-align: right;">in section</p>	 <p style="text-align: right;">in section</p>
Lateral Mounting		

2. Land Dimensions

2-1. Please refer to the land dimensions in table 1 for flow soldering, table 2 for reflow soldering.
 Please confirm the suitable land dimension by evaluating of the actual SET / PCB.

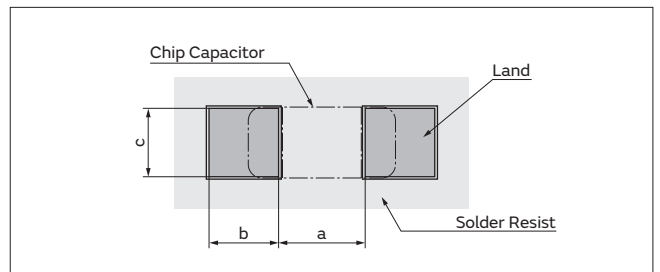

Table 1 Flow Soldering Method

Series	Chip Dimension Code (L/W)	Chip (L×W)	a	b	c
GRT/GCM/GC3/GCD/GCJ (Rated Voltage: above 250VDC (for GCJ alone))	18	1.6×0.8	0.6 to 1.0	0.8 to 0.9	0.6 to 0.8
	21	2.0×1.25	1.0 to 1.2	0.9 to 1.0	0.8 to 1.1
	31	3.2×1.6	2.2 to 2.6	1.0 to 1.1	1.0 to 1.4

Flow soldering can only be used for products with a chip size from 1.6x0.8mm to 3.2x1.6mm.

(in mm)

Table 2 Reflow Soldering Method

Series	Chip Dimension Code (L/W)	Chip (L×W)	a	b	c
GRT/GCM/GC3/ GCD/GCE/GCJ	03	0.6×0.3	0.2 to 0.3	0.2 to 0.35	0.2 to 0.4
	15	1.0×0.5	0.3 to 0.5	0.35 to 0.45	0.4 to 0.6
	18	1.6×0.8	0.6 to 0.8	0.6 to 0.7	0.6 to 0.8
	21	2.0×1.25	1.0 to 1.2	0.6 to 0.7	0.8 to 1.1
	31	3.2×1.6	2.2 to 2.4	0.8 to 0.9	1.0 to 1.4
	32	3.2×2.5	2.0 to 2.4	1.0 to 1.2	1.8 to 2.3
	43	4.5×3.2	3.0 to 3.5	1.2 to 1.4	2.3 to 3.0
	55	5.7×5.0	4.0 to 4.6	1.4 to 1.6	3.5 to 4.8

(in mm)

Continued on the following page. ↗

Notice

Continued from the preceding page. ↘

<Applicable to Part Number KCM/KC3/KCA>

Series	Chip Dimension Code (L/W)	Chip (L×W)	a	b	c
KCM/KC3	55	5.7×5.0	2.6	2.7	5.6
KCA	55	5.7×5.0	3.2	2.7	5.6

(in mm)

<Applicable to beyond Rated Voltage of 200VDC>

2-2. Dimensions of Slit (Example)

Preparing the slit helps flux cleaning and resin coating on the back of the capacitor.

However, the length of the slit design should be as short as possible to prevent mechanical damage in the capacitor.

A longer slit design might receive more severe mechanical stress from the PCB.

Recommended slit design is shown in the Table.

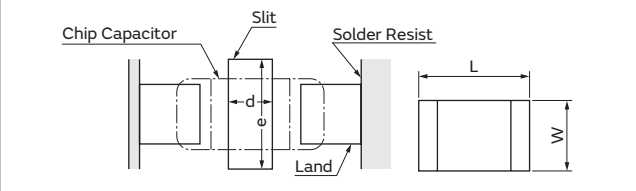

L×W	d	e
1.6×0.8	—	—
2.0×1.25	—	—
3.2×1.6	1.0 to 2.0	3.2 to 3.7
3.2×2.5	1.0 to 2.0	4.1 to 4.6
4.5×2.0	1.0 to 2.8	3.6 to 4.1
4.5×3.2	1.0 to 2.8	4.8 to 5.3
5.7×2.8	1.0 to 4.0	4.4 to 4.9
5.7×5.0	1.0 to 4.0	6.6 to 7.1

(in mm)

<Applicable to NFM Series>

Land Pattern + Solder Resist
 Land Pattern
 Solder Resist
 (in mm)

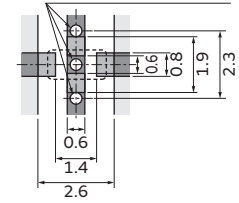
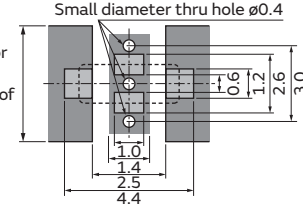
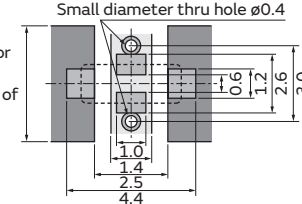
Series	Land Dimensions	
NFM21HC	<p>● Reflow Soldering</p> <p>NFM21HC</p> <p>Small diameter thru hole $\phi 0.4$</p> 	
	<p>● Reflow Soldering Chip mounting side</p> <p>NFM31HK*1</p> <p>Small diameter thru hole $\phi 0.4$</p> <p>10mm or more (in case of 10A)</p>  <p>*1 For large current design, width of signal land pattern should be wider not less than 1mm per 1A (1mm/A). For example, in case of 10A, signal land pattern width should be 10mm or more. (1mm/A*10A=10mm)</p>	<p>● Flow Soldering Chip mounting side</p> <p>NFM31HK*1</p> <p>Small diameter thru hole $\phi 0.4$</p> <p>10mm or more (in case of 10A)</p>  <p>*1 For large current design, width of signal land pattern should be wider not less than 1mm per 1A (1mm/A). For example, in case of 10A, signal land pattern width should be 10mm or more. (1mm/A*10A=10mm)</p>

Continued on the following page. ↗

Notice

Continued from the preceding page. ↘

3. Board Design

When designing the board, keep in mind that the amount of strain which occurs will increase depending on the size and material of the board.

[Relationship with amount of strain to the board thickness, length, width, etc.]

$$\epsilon = \frac{3PL}{2Ewh^2}$$

Relationship between load and strain

- ε: Strain on center of board (μst)
- L: Distance between supporting points (mm)
- w: Board width (mm)
- h: Board thickness (mm)
- E: Elastic modulus of board (N/m²=Pa)
- Y: Deflection (mm)
- P: Load (N)

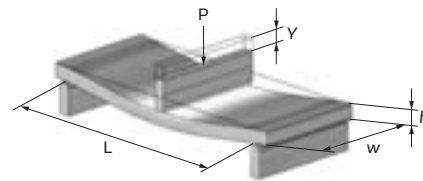

When the load is constant, the following relationship can be established.

- As the distance between the supporting points (L) increases, the amount of strain also increases.
→Reduce the distance between the supporting points.
- As the elastic modulus (E) decreases, the amount of strain increases.
→Increase the elastic modulus.
- As the board width (w) decreases, the amount of strain increases.
→Increase the width of the board.
- As the board thickness (h) decreases, the amount of strain increases.
→Increase the thickness of the board.
Since the board thickness is squared, the effect on the amount of strain becomes even greater.

2. Adhesive Application

If you want to temporarily attach the capacitor to the board using an adhesive agent before soldering the capacitor, first be sure that the conditions are appropriate for affixing the capacitor. If the dimensions of the land, the type of adhesive, the amount of coating, the contact surface area, the curing temperature, or other conditions are inappropriate, the characteristics of the capacitor may deteriorate.

1. Selection of Adhesive

1-1. Depending on the type of adhesive, there may be a decrease in insulation resistance. In addition, there is a chance that the capacitor might crack from contractile stress due to the difference in the contraction rate of the capacitor and the adhesive.

1-2. If there is not enough adhesive, the contact surface area is too small, or the curing temperature or curing time are inadequate, the adhesive strength will be insufficient and the capacitor may loosen or become disconnected during transportation or soldering. If there is too much adhesive, for example if it overflows onto the land, the result could be soldering defects, loss of electrical connection, insufficient curing, or slippage after the capacitor is mounted.

Furthermore, if the curing temperature is too high or the curing time is too long, not only will the adhesive

strength be reduced, but solderability may also suffer due to the effects of oxidation on the terminations (outer electrodes) of the capacitor and the land surface on the board.

(1) Selection of Adhesive

Epoxy resins are a typical class of adhesive.

To select the proper adhesive, consider the following points.

- 1) There must be enough adhesive strength to prevent the component from loosening or slipping during the mounting process.
- 2) The adhesive strength must not decrease when exposed to moisture during soldering.
- 3) The adhesive must have good coatability and shape retention properties.
- 4) The adhesive must have a long pot life.
- 5) The curing time must be short.
- 6) The adhesive must not be corrosive to the exterior of the capacitor or the board.
- 7) The adhesive must have good insulation properties.
- 8) The adhesive must not emit toxic gases or otherwise be harmful to health.
- 9) The adhesive must be free of halogenated compounds.

Continued on the following page. ↗

GRT Series

GCM Series

GC3 Series

GCJ Series

GCD Series

GCE Series

NMF Series

KCM Series

KC3 Series

KCA Series

GCG Series

Notice

Notice

Continued from the preceding page. ↘

(2) Use the following illustration as a guide to the amount of adhesive to apply.

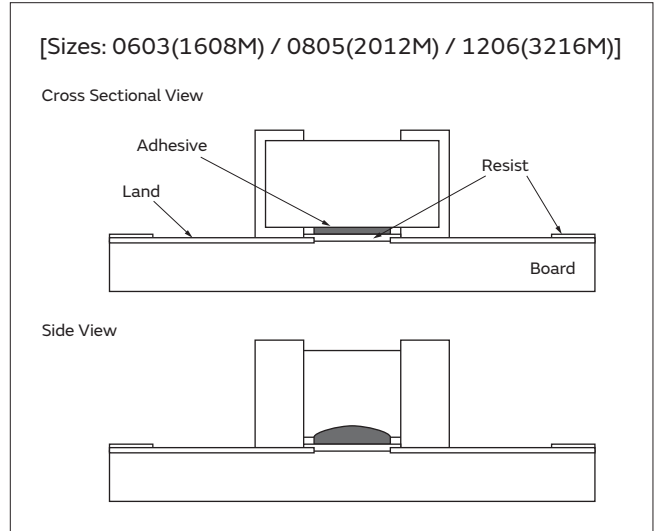

3. Adhesive Curing

1. Insufficient curing of the adhesive can cause chips to disconnect during flow soldering and causes deterioration in the insulation resistance between the terminations due to moisture absorption.
 Control curing temperature and time in order to prevent insufficient hardening.

4. Flux for Flow Soldering

1. An excessive amount of flux generates a large quantity of flux gas, which can cause a deterioration of solderability, so apply flux thinly and evenly throughout. (A foaming system is generally used for flow soldering.)
2. Flux containing too high a percentage of halide may cause corrosion of the terminations unless there is sufficient cleaning. Use flux with a halide content of 0.1% max.
3. Do not use strong acidic flux.

4. Do not use water-soluble flux.*
 (*Water-soluble flux can be defined as non-rosin type flux including wash-type flux and non-wash-type flux.)

5. Flow Soldering

- Set temperature and time to ensure that leaching of the termination does not exceed 25% of the chip end area as a single chip (full length of the edge A-B-C-D shown at right) and 25% of the length A-B shown as mounted on substrate.

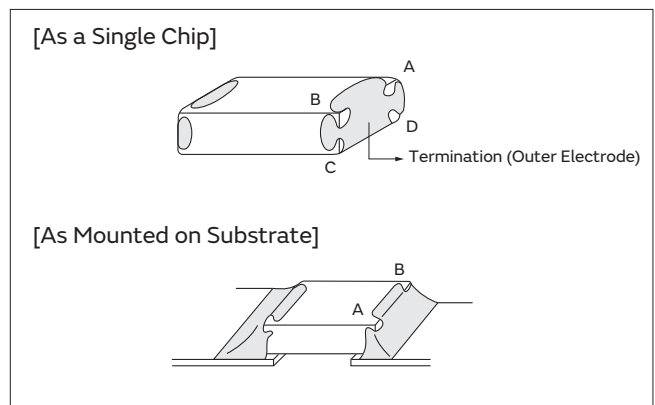

6. Reflow Soldering

The halogen system substance and organic acid are included in solder paste, and a chip corrodes by this kind of solder paste.

- Do not use strong acid flux.
- Do not use water-soluble flux*.
 (*Water-soluble flux can be defined as non-rosin type flux including wash-type flux and non-wash-type flux.)

Continued on the following page. ↗

Notice

Continued from the preceding page. ↘

7. Washing

1. Please evaluate the capacitor using actual cleaning equipment and conditions to confirm the quality, and select the solvent for cleaning.
2. Unsuitable cleaning solvent may leave residual flux or other foreign substances, causing deterioration of electrical characteristics and the reliability of the capacitors.

8. Coating

1. A crack may be caused in the capacitor due to the stress of the thermal contraction of the resin during curing process.
The stress is affected by the amount of resin and curing contraction.
Select a resin with low curing contraction.
The difference in the thermal expansion coefficient between a coating resin or a molding resin and the capacitor may cause the destruction and deterioration of the capacitor such as a crack or peeling, and lead to the deterioration of insulation resistance or dielectric breakdown.

3. Select the proper cleaning conditions.
3-1. Improper cleaning conditions (excessive or insufficient) may result in deterioration of the performance of the capacitors.

Select a resin for which the thermal expansion coefficient is as close to that of the capacitor as possible.
A silicone resin can be used as an under-coating to buffer against the stress.

2. Select a resin that is less hygroscopic.
Using hygroscopic resins under high humidity conditions may cause the deterioration of the insulation resistance of a capacitor.
An epoxy resin can be used as a less hygroscopic resin.
3. The halogen system substance and organic acid are included in coating material, and a chip corrodes by the kind of Coating material.
Do not use strong acid type.

Other

1. Transportation

1. The performance of a capacitor may be affected by the conditions during transportation.
1-1. The capacitors shall be protected against excessive temperature, humidity, and mechanical force during transportation.
(1) Climatic condition
 - low air temperature: -40°C
 - change of temperature air/air: -25°C/+25°C
 - low air pressure: 30 kPa
 - change of air pressure: 6 kPa/min.
(2) Mechanical condition
Transportation shall be done in such a way that the boxes are not deformed and forces are not directly passed on to the inner packaging.
- 1-2. Do not apply excessive vibration, shock, or pressure to the capacitor.
(1) When excessive mechanical shock or pressure is applied to a capacitor, chipping or cracking may occur in the ceramic body of the capacitor.
(2) When the sharp edge of an air driver, a soldering iron, tweezers, a chassis, etc. impacts strongly on the surface of the capacitor, the capacitor may crack and short-circuit.
- 1-3. Do not use a capacitor to which excessive shock was applied by dropping, etc.
A capacitor dropped accidentally during processing may be damaged.

2. Characteristics Evaluation in the Actual System

1. Evaluate the capacitor in the actual system, to confirm that there is no problem with the performance and specification values in a finished product before using.
2. Since a voltage dependency and temperature dependency exists in the capacitance of high dielectric type ceramic capacitors, the capacitance may change depending on the operating conditions in the actual system. Therefore, be sure to evaluate the various characteristics, such as the leakage current and noise absorptivity, which will affect the capacitance value of the capacitor.
3. In addition, voltages exceeding the predetermined surge may be applied to the capacitor by the inductance in the actual system. Evaluate the surge resistance in the actual system as required.

<Applicable to NFM Series>

4. The effects of noise suppression can vary depending on the usage conditions, including differences in the circuit or IC to be used, the type of noise, the shape of the pattern to be mounted, and the mounting location. Be sure to verify the effect on the actual device in advance.

GRT Series

GCM Series

GC3 Series

GCJ Series

GCD Series

GCE Series

NMF Series

KCM Series

KC3 Series

KCA Series

GCG Series

Notice

Design Support Tool "SimSurfing"

<http://www.murata.com/simsurfing/>

This is the latest tool to get the electrical characteristics for Capacitors, Inductors, and EMI Suppression Filters, and to simulate Thermistors' behavior !



Characteristics viewer
 You can easily search and download the following data for Multilayer Ceramic Capacitors, Polymer Capacitors, EMI Suppression Filters (Three-terminal Capacitors, Ferrite Beads) and Power/RF Inductors.

Components performance simulator
 You can search by the simulation on simple circuits for Thermistors.

Selection tool
 You can select Medium voltage Capacitors and Power Inductors according to conditions of use.
 * Medium voltage: Rated Voltage 250V and over

Search tool
 You can search the Murata timing device (CERALOCK® and crystal units) that is most suitable for your IC and access information about the recommended circuit constant setting.

If you register as a "my Murata" user (<https://my.murata.com/en/web/mymurata/>), you can use Enhanced SimSurfing.

Usage example of "Multilayer Ceramic Capacitors"

1 Select the products

- (1) By performance/type
- (2) By part number

2 Show graph

Click each button on each tab of [Basic], [S-parameter] and [Detailed].

3 Data download

- Click each purple button in this area.
- Click "CSV output" button.

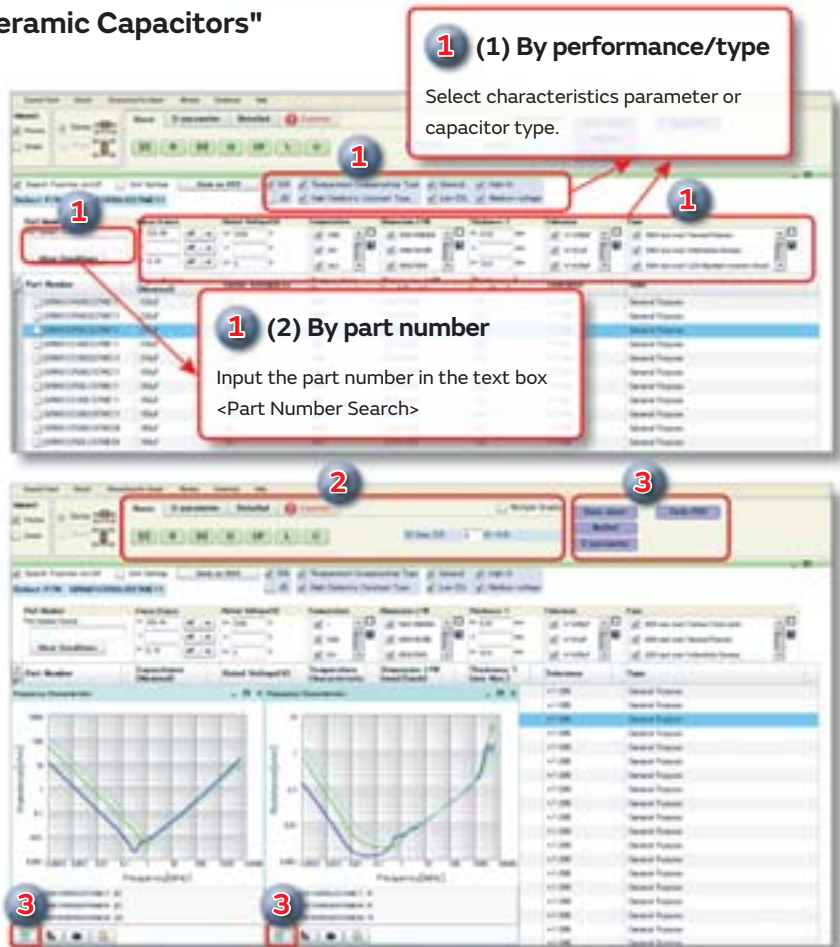

1 (1) By performance/type
 Select characteristics parameter or capacitor type.

1 (2) By part number
 Input the part number in the text box <Part Number Search>

2
 Click each button on each tab of [Basic], [S-parameter] and [Detailed].

3
 Click each purple button in this area. Click "CSV output" button.

* Images are as of October 2015. Be assured that this software will be updated frequently.

<http://www.murata.com/simsurfing/>

Web page Introduction

muRata Product Search



1 Search by Part Number <http://psearch.en.murata.com/capacitor/partnumber/>



You can search for capacitors by specifying the alphanumeric characters in the part number. The packing codes shown contain the substitute character "#". If you enter the official packing code, part numbers that contain that packing code will be matched.

2 Search by Specifications <http://psearch.en.murata.com/capacitor/spec/smd/>



You can search for SMD, lead type, or screw termination type capacitors by indicating specifications such as application, capacitance, rated voltage, or temperature characteristics.

You can narrow your search by entering values of ranges, and by specifying product characteristics.

The items for narrowing searches are linked, so specifying one condition causes selectable options for the other items to allow input only of conditions that match the relevant part numbers.

3 Search in the Lineups <http://psearch.en.murata.com/capacitor/lineup/>

You can search for capacitors by specifying the series lineup.

You can also confirm items such as characteristics and applications on each series page.

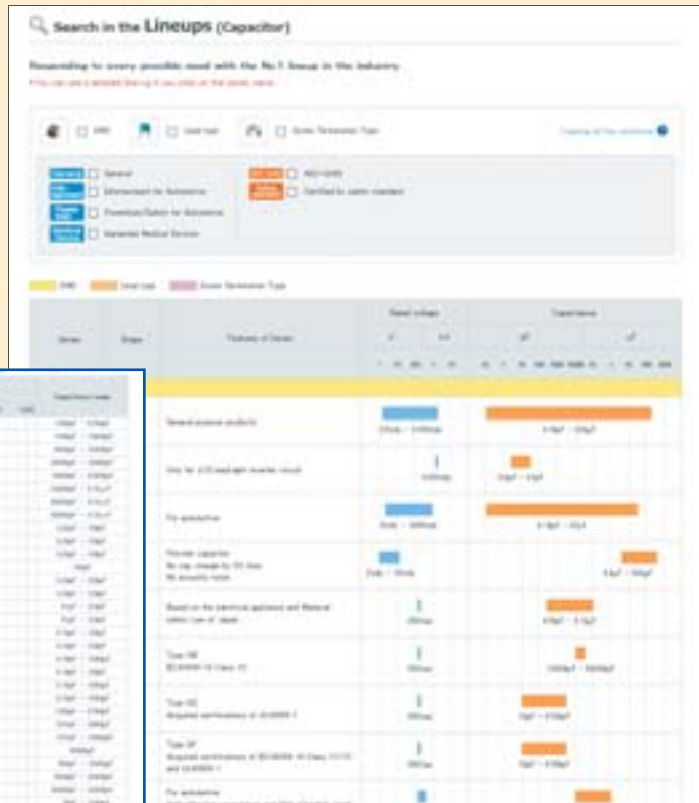

Capacitance chart in Series page.

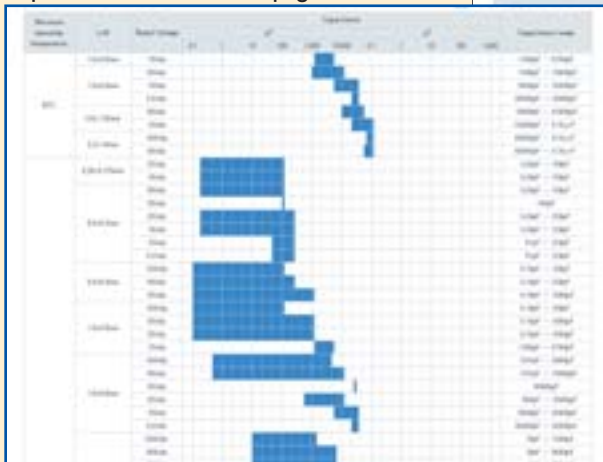

[Search result]

Compares the characteristics of the checked part numbers.

Displays the number of hits for the current search conditions in real time.

Clicking on each search condition button brings up a menu, allowing you to narrow the search results to match the selected condition in real time.

Click "Current search terms" to display a menu, from which you can confirm the current conditions for narrowing the search results.

Click the ▲ mark for each item to switch between ascending and descending display.

Click a product name to display a details page listing more in-depth information (→ P22).

You can download detailed spec sheets.

Icons enable you to check the status and characteristics of products at a glance.

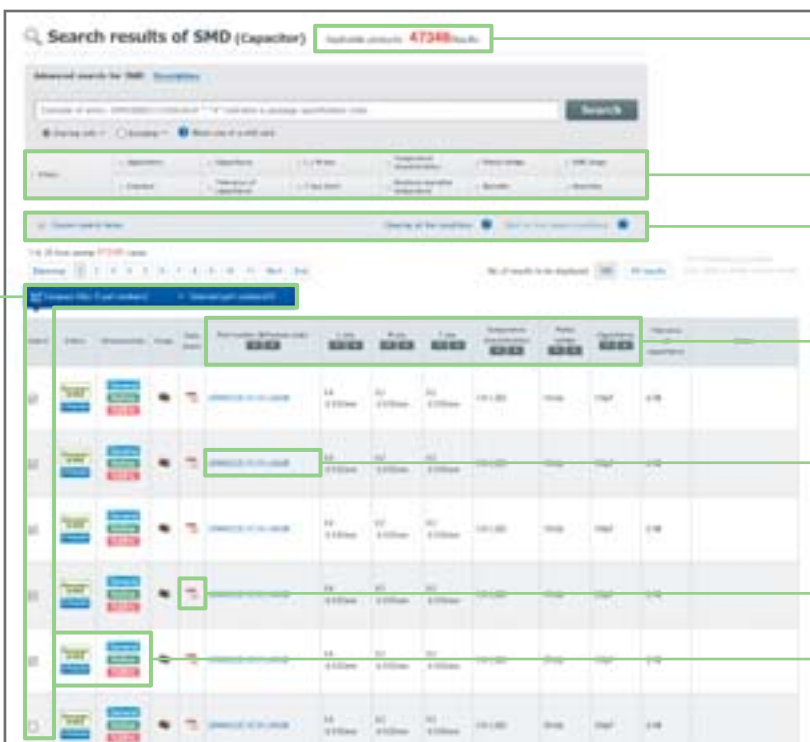

Global Locations

For details please visit www.murata.com



⚠ Note

1 Export Control

For customers outside Japan:

No Murata products should be used or sold, through any channels, for use in the design, development, production, utilization, maintenance or operation of, or otherwise contribution to (1) any weapons (Weapons of Mass Destruction [nuclear, chemical or biological weapons or missiles] or conventional weapons) or (2) goods or systems specially designed or intended for military end-use or utilization by military end-users.

For customers in Japan:

For products which are controlled items subject to the "Foreign Exchange and Foreign Trade Law" of Japan, the export license specified by the law is required for export.

2 Please contact our sales representatives or product engineers before using the products in this catalog for the applications listed below, which require especially high reliability for the prevention of defects which might directly damage a third party's life, body or property, or when one of our products is intended for use in applications other than those specified in this catalog.

- ① Aircraft equipment
- ② Aerospace equipment
- ③ Undersea equipment
- ④ Power plant equipment
- ⑤ Medical equipment
- ⑥ Transportation equipment (vehicles, trains, ships, etc.)
- ⑦ Traffic signal equipment
- ⑧ Disaster prevention / crime prevention equipment
- ⑨ Data-processing equipment
- ⑩ Application of similar complexity and/or reliability requirements to the applications listed above

3 Product specifications in this catalog are as of May 2017. They are subject to change or our products in it may be discontinued without advance notice. Please check with our sales representatives or product engineers before ordering. If there are any questions, please contact our sales representatives or product engineers.

4 Please read rating and ⚠CAUTION (for storage, operating, rating, soldering, mounting and handling) in this catalog to prevent smoking and/or burning, etc.

5 This catalog has only typical specifications. Therefore, please approve our product specifications or transact the approval sheet for product specifications before ordering.

6 Please note that unless otherwise specified, we shall assume no responsibility whatsoever for any conflict or dispute that may occur in connection with the effect of our and/or a third party's intellectual property rights and other related rights in consideration of your use of our products and/or information described or contained in our catalogs. In this connection, no representation shall be made to the effect that any third parties are authorized to use the rights mentioned above under licenses without our consent.

7 No ozone depleting substances (ODS) under the Montreal Protocol are used in our manufacturing process.

Murata Manufacturing Co., Ltd.

www.murata.com

muRata
INNOVATOR IN ELECTRONICS

Looking for pricing, stock, or lifecycle information?

Click below to explore more details on WIN SOURCE:

- ⊖ [View GCM32ER70J476ME19L on WIN SOURCE](#)
- ⊖ [Murata Electronics North America Information](#)

Optimize Your Supply Chain with WIN SOURCE Solutions

- ✓ Global Sourcing Solution
- ✓ Obsolete Management
- ✓ Cost Control Management
- ✓ Shortage Management
- ✓ Alternative Solution
- ✓ Excess Inventory Management