



**THE DATASHEET OF  
MOC8101-X017T**





## Optocoupler, Phototransistor Output, no Base Connection

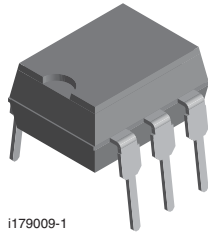

i179009-1

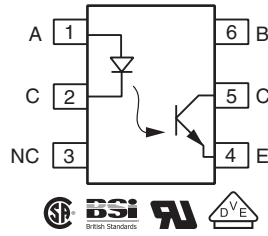

### FEATURES

- Isolation test voltage, 5300 V<sub>RMS</sub>
- No base terminal connection for improved common mode interface immunity
- Long term stability
- Industry standard dual in line package
- Compliant to RoHS Directive 2002/95/EC and in accordance to WEEE 2002/96/EC



RoHS COMPLIANT

### DESCRIPTION

The MOC8101, MOC8102, MOC8103, MOC8104, MOC8105 family optocoupler consisting of a gallium arsenide infrared emitting diode optically coupled to a silicon planar phototransistor detector in a plastic plug-in DIP-6 package.

The coupling device is suitable for signal transmission between two electrically separated circuits. The potential difference between the circuits to be coupled should not exceed the maximum permissible reference voltages.

The base terminal of the MOC8101, MOC8102, MOC8103, MOC8104, MOC8105 is not connected, resulting in a substantially improved common mode interference immunity.

### AGENCY APPROVALS

- UL1577, file no. E52744 system code H or J, double protection
- CSA 93751
- BSI IEC 60950; IEC 60065
- DIN EN 60747-5-5 (VDE 0884) available with option 1

| ORDERING INFORMATION     |   |               |               |              |               |           |         |   |                |   |   |   |               |         |          |          |          |
|--------------------------|---|---------------|---------------|--------------|---------------|-----------|---------|---|----------------|---|---|---|---------------|---------|----------|----------|----------|
| M                        | O | C             | 8             | 1            | 0             | #         | -       | # | X              | 0 | # | # | T             | DIP-#   | Option 6 | Option 7 | Option 9 |
| PART NUMBER              |   |               |               |              |               |           | CTR BIN |   | PACKAGE OPTION |   |   |   | TAPE AND REEL | 7.62 mm | 10.16 mm | > 0.7 mm | > 0.1 mm |
| AGENCY CERTIFIED/PACKAGE |   | CTR (%)       |               |              |               |           |         |   |                |   |   |   |               |         |          |          |          |
|                          |   | 10 mA         |               |              |               |           |         |   |                |   |   |   |               |         |          |          |          |
| UL, CSA, BSI             |   | 50 to 80      | 73 to 117     | 108 to 173   | 160 to 256    | 65 to 133 |         |   |                |   |   |   |               |         |          |          |          |
| DIP-6                    |   | MOC8101       | MOC8102       | MOC8103      | MOC8104       | MOC8105   |         |   |                |   |   |   |               |         |          |          |          |
| DIP-6, 400 mil, option 6 |   | -             | MOC8102-X006  | -            | -             | -         |         |   |                |   |   |   |               |         |          |          |          |
| SMD-6, option 9          |   | MOC8101-X009  | MOC8102-X009  | -            | -             | -         |         |   |                |   |   |   |               |         |          |          |          |
| VDE, UL, CSA, BSI        |   | 50 to 80      | 73 to 117     | 108 to 173   | 160 to 256    | 65 to 133 |         |   |                |   |   |   |               |         |          |          |          |
| DIP-6                    |   | MOC8101-X001  | -             | MOC8103-X001 | -             | -         |         |   |                |   |   |   |               |         |          |          |          |
| DIP-6, 400 mil           |   | -             | MOC8102-X016  | -            | MOC8104-X016  | -         |         |   |                |   |   |   |               |         |          |          |          |
| SMD-6, option 7          |   | MOC8101-X017T | MOC8102-X017T | -            | -             | -         |         |   |                |   |   |   |               |         |          |          |          |
| SMD-6, option 9          |   | -             | -             | -            | MOC8104-X019T | -         |         |   |                |   |   |   |               |         |          |          |          |

### Note

- Additional options may be possible, please contact sales office.



| ABSOLUTE MAXIMUM RATINGS (T <sub>amb</sub> = 25 °C, unless otherwise specified) |   |                   |                    |                  |
|---|---|-------------------|--------------------|------------------|
| PARAMETER   | TEST CONDITION  | SYMBOL            | VALUE              | UNIT             |
| <b>INPUT</b>  |   |                   |                    |                  |
| Reverse voltage   |   | V <sub>R</sub>    | 6.0                | V                |
| Forward continuous current  |   | I <sub>F</sub>    | 60                 | mA               |
| Surge forward current   | t ≤ 10 μs   | I <sub>FSM</sub>  | 2.5                | A                |
| Power dissipation   |   | P <sub>diss</sub> | 100                | mW               |
| Derate linearly from 25°C   |   |                   | 1.33               | mW/°C            |
| <b>OUTPUT</b>   |   |                   |                    |                  |
| Collector emitter breakdown voltage   |   | BV <sub>CEO</sub> | 30                 | V                |
| Emitter collector breakdown voltage   |   | BV <sub>ECO</sub> | 7.0                | V                |
| Collector current   |   | I <sub>C</sub>    | 50                 | mA               |
| Derate linearly from 25°C   |   |                   | 2.0                | mW/°C            |
| Power dissipation   |   | P <sub>diss</sub> | 150                | mW               |
| <b>COUPLER</b>  |   |                   |                    |                  |
| Isolation test voltage  |   | V <sub>ISO</sub>  | 5300               | V <sub>RMS</sub> |
| Creepage distance   |   |                   | ≥ 7.0              | mm               |
|   |   |                   | 8.0 <sup>(2)</sup> | mm               |
| Clearance distance  |   |                   | ≥ 7.0              | mm               |
|   |   |                   | 8.0 <sup>(2)</sup> | mm               |
| Isolation thickness between emitter and detector                                |   |                   | ≥ 0.4              | mm               |
| Comparative tracking index per DIN IEC 112/VDE 0303, part 1                     |   | CTI               | 175                |                  |
| Isolation resistance  | V <sub>IO</sub> = 500 V   | R <sub>IO</sub>   | 10 <sup>12</sup>   | Ω                |
| Derate linearly from 25 °C  |   |                   | 3.33               | mW/°C            |
| Total power dissipation   |   | P <sub>tot</sub>  | 250                | mW               |
| Storage temperature   |   | T <sub>stg</sub>  | - 55 to + 150      | °C               |
| Operating temperature   |   | T <sub>amb</sub>  | - 55 to + 100      | °C               |
| Junction temperature  |   | T <sub>j</sub>    | 100                | °C               |
| Soldering temperature <sup>(1)</sup>  | max. 10 s, dip soldering;<br>distance to seating plane ≥ 1.5 mm | T <sub>slid</sub> | 260                | °C               |

**Notes**

- Stresses in excess of the absolute maximum ratings can cause permanent damage to the device. Functional operation of the device is not implied at these or any other conditions in excess of those given in the operational sections of this document. Exposure to absolute maximum ratings for extended periods of the time can adversely affect reliability.
- (1) Refer to reflow profile for soldering conditions for surface mounted devices (SMD). Refer to wave profile for soldering conditions for through hole devices (DIP).
- (2) Applies to wide bending option 6.

| ELECTRICAL CHARACTERISTICS (T <sub>amb</sub> = 25 °C, unless otherwise specified) |   |         |                    |      |      |      |      |
|---|---|---------|--------------------|------|------|------|------|
| PARAMETER   | TEST CONDITION                                    | PART    | SYMBOL             | MIN. | TYP. | MAX. | UNIT |
| <b>INPUT</b>  |   |         |                    |      |      |      |      |
| Forward voltage   | I <sub>F</sub> = 10 mA                            |         | V <sub>F</sub>     |      | 1.25 | 1.5  | V    |
| Breakdown voltage   | I <sub>R</sub> = 10 μA                            |         | V <sub>BR</sub>    | 6.0  |      |      | V    |
| Reverse current   | V <sub>R</sub> = 6.0 V                            |         | I <sub>R</sub>     |      | 0.01 | 10   | μA   |
| Capacitance   | V <sub>R</sub> = 0 V, f = 1.0 MHz                 |         | C <sub>O</sub>     |      | 25   |      | pF   |
| Thermal resistance  |   |         | R <sub>thja</sub>  |      | 750  |      | K/W  |
| <b>OUTPUT</b>   |   |         |                    |      |      |      |      |
| Collector emitter capacitance   | V <sub>CE</sub> = 5.0 V, f = 1.0 MHz              |         | C <sub>CE</sub>    |      | 5.2  |      | pF   |
| Collector emitter dark current  | V <sub>CE</sub> = 10 V, T <sub>amp</sub> = 25 °C  | MOC8101 | I <sub>CEO1</sub>  |      | 1.0  | 50   | nA   |
|   | V <sub>CE</sub> = 10 V, T <sub>amp</sub> = 100 °C | MOC8102 | I <sub>CEO1</sub>  |      | 1.0  |      | μA   |
| Collector emitter breakdown voltage   | I <sub>C</sub> = 1.0 mA                           |         | BV <sub>CEO</sub>  | 30   |      |      | V    |
| Emitter collector breakdown voltage   | I <sub>E</sub> = 100 μA                           |         | BV <sub>ECO</sub>  | 7.0  |      |      | V    |
| Thermal resistance  |   |         | R <sub>thja</sub>  |      | 500  |      | K/W  |
| <b>COUPLER</b>  |   |         |                    |      |      |      |      |
| Saturation voltage collector emitter  | I <sub>F</sub> = 5.0 mA                           |         | V <sub>CEsat</sub> |      | 0.25 | 0.4  | V    |
| Coupling capacitance  |   |         | C <sub>C</sub>     |      | 0.6  |      | pF   |

**Note**

- Minimum and maximum values are testing requirements. Typical values are characteristics of the device and are the result of engineering evaluation. Typical values are for information only and are not part of the testing requirements.



| CURRENT TRANSFER RATIO ( $T_{amb} = 25\text{ }^{\circ}\text{C}$ , unless otherwise specified) |   |         |        |      |      |      |      |
|---|---|---------|--------|------|------|------|------|
| PARAMETER   | TEST CONDITION                                | PART    | SYMBOL | MIN. | TYP. | MAX. | UNIT |
| Current transfer ratio  | $V_{CE} = 10\text{ V}$ , $I_F = 10\text{ mA}$ | MOC8101 | CTR    | 50   |      | 80   | %    |
|   |   | MOC8102 | CTR    | 73   |      | 117  | %    |
|   |   | MOC8103 | CTR    | 108  |      | 173  | %    |
|   |   | MOC8104 | CTR    | 160  |      | 256  | %    |
|   |   | MOC8105 | CTR    | 65   |      | 133  | %    |

| SWITCHING CHARACTERISTICS ( $T_{amb} = 25\text{ }^{\circ}\text{C}$ , unless otherwise specified) |  |           |      |      |      |               |  |
|--|--|-----------|------|------|------|---------------|--|
| PARAMETER  | TEST CONDITION   | SYMBOL    | MIN. | TYP. | MAX. | UNIT          |  |
| Turn-on time   | $V_{CC} = 10\text{ V}$ , $I_C = 2.0\text{ mA}$ , $R_L = 100\text{ }\Omega$ | $t_{on}$  |      | 3.0  |      | $\mu\text{s}$ |  |
| Turn-off time  | $V_{CC} = 10\text{ V}$ , $I_C = 2.0\text{ mA}$ , $R_L = 100\text{ }\Omega$ | $t_{off}$ |      | 2.3  |      | $\mu\text{s}$ |  |
| Rise time  | $V_{CC} = 10\text{ V}$ , $I_C = 2.0\text{ mA}$ , $R_L = 100\text{ }\Omega$ | $t_r$     |      | 2.0  |      | $\mu\text{s}$ |  |
| Fall time  | $V_{CC} = 10\text{ V}$ , $I_C = 2.0\text{ mA}$ , $R_L = 100\text{ }\Omega$ | $t_f$     |      | 2.0  |      | $\mu\text{s}$ |  |
| Cut off frequency  |  | $f_{co}$  |      | 250  |      | kHz           |  |

**TYPICAL CHARACTERISTICS** ( $T_{amb} = 25\text{ }^{\circ}\text{C}$ , unless otherwise specified)

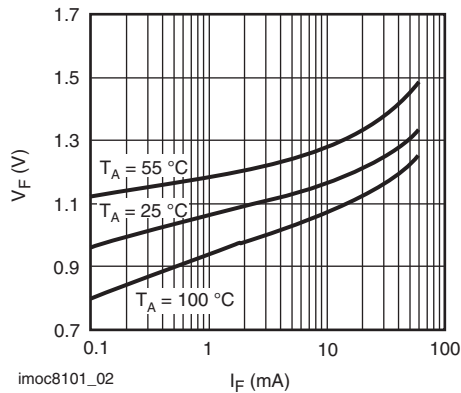

imoc8101\_02

Fig. 1 - Forward Voltage vs. Forward Current

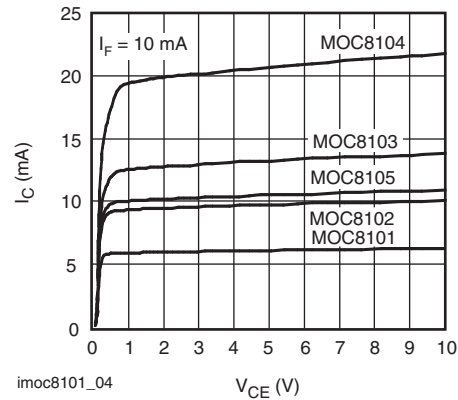

imoc8101\_04

Fig. 3 - Collector Current vs. Collector Emitter Voltage

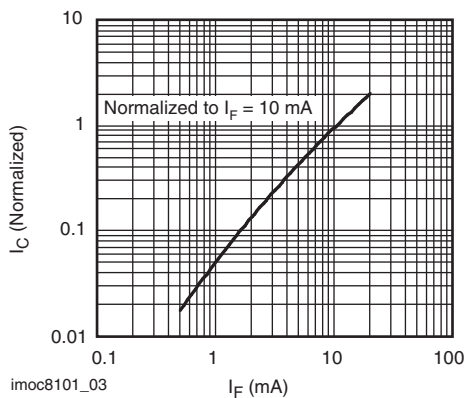

imoc8101\_03

Fig. 2 - Collector Current vs. LED Forward Current

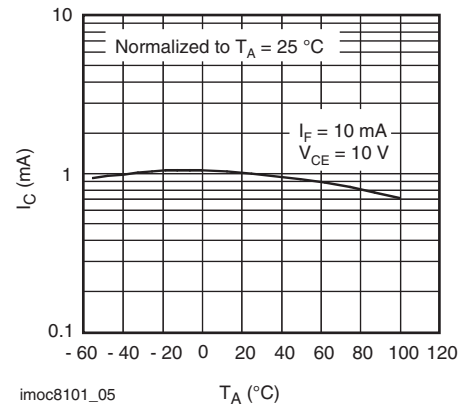

imoc8101\_05

Fig. 4 - Collector Current vs. Ambient Temperature

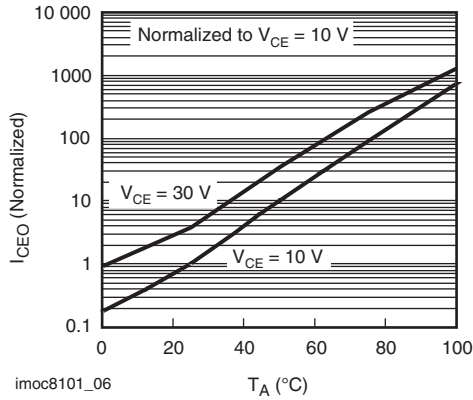

Fig. 5 - Collector Emitter Dark Current vs. Ambient Temperature

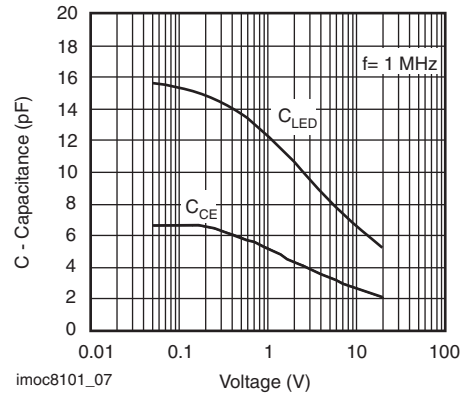
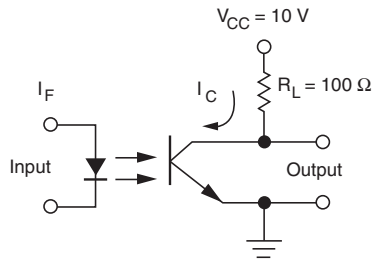
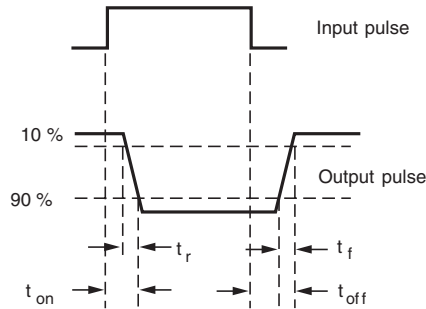

Fig. 6 - Capacitance vs. Voltage



Test circuit

imoc81010\_01



Waveforms

Fig. 7 - Switching Time Test Circuit and Waveforms



## PACKAGE DIMENSIONS in millimeters

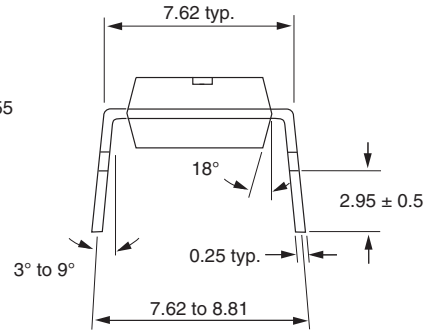
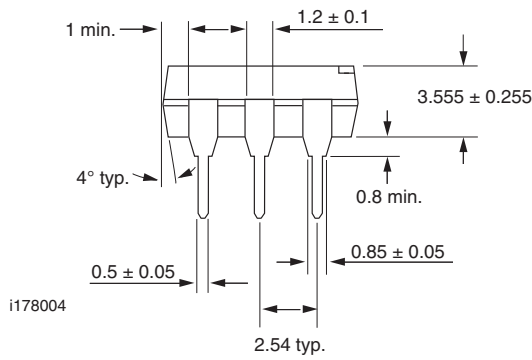
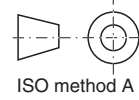
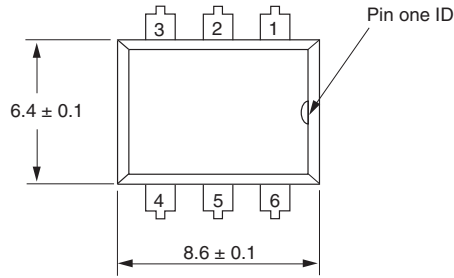

i178004

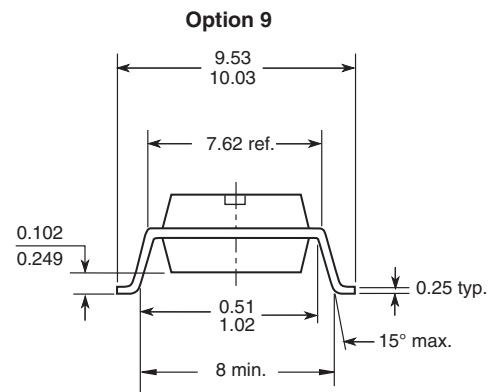
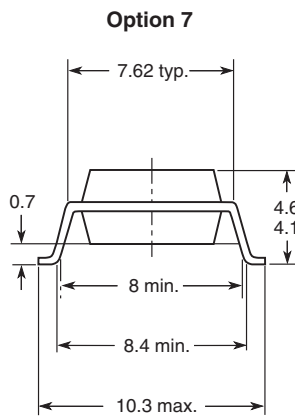
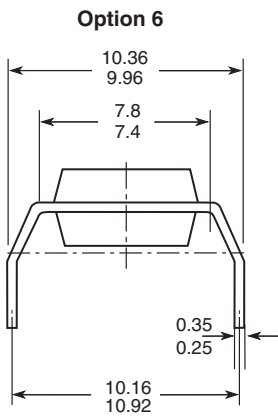

18450





## **Disclaimer**

ALL PRODUCT, PRODUCT SPECIFICATIONS AND DATA ARE SUBJECT TO CHANGE WITHOUT NOTICE TO IMPROVE RELIABILITY, FUNCTION OR DESIGN OR OTHERWISE.

Vishay Intertechnology, Inc., its affiliates, agents, and employees, and all persons acting on its or their behalf (collectively, "Vishay"), disclaim any and all liability for any errors, inaccuracies or incompleteness contained in any datasheet or in any other disclosure relating to any product.

Vishay makes no warranty, representation or guarantee regarding the suitability of the products for any particular purpose or the continuing production of any product. To the maximum extent permitted by applicable law, Vishay disclaims (i) any and all liability arising out of the application or use of any product, (ii) any and all liability, including without limitation special, consequential or incidental damages, and (iii) any and all implied warranties, including warranties of fitness for particular purpose, non-infringement and merchantability.

Statements regarding the suitability of products for certain types of applications are based on Vishay's knowledge of typical requirements that are often placed on Vishay products in generic applications. Such statements are not binding statements about the suitability of products for a particular application. It is the customer's responsibility to validate that a particular product with the properties described in the product specification is suitable for use in a particular application. Parameters provided in datasheets and / or specifications may vary in different applications and performance may vary over time. All operating parameters, including typical parameters, must be validated for each customer application by the customer's technical experts. Product specifications do not expand or otherwise modify Vishay's terms and conditions of purchase, including but not limited to the warranty expressed therein.

Except as expressly indicated in writing, Vishay products are not designed for use in medical, life-saving, or life-sustaining applications or for any other application in which the failure of the Vishay product could result in personal injury or death. Customers using or selling Vishay products not expressly indicated for use in such applications do so at their own risk. Please contact authorized Vishay personnel to obtain written terms and conditions regarding products designed for such applications.

No license, express or implied, by estoppel or otherwise, to any intellectual property rights is granted by this document or by any conduct of Vishay. Product names and markings noted herein may be trademarks of their respective owners.

## Looking for pricing, stock, or lifecycle information?

Click below to explore more details on WIN SOURCE:

 [View MOC8101-X017T on WIN SOURCE](#)

 [Vishay Information](#)

## Optimize Your Supply Chain with WIN SOURCE Solutions

-  Global Sourcing Solution
-  Obsolete Management
-  Cost Control Management
-  Shortage Management
-  Alternative Solution
-  Excess Inventory Management