



**THE DATASHEET OF  
BUS1DJC3GWZ-E2**



# 1ch Ultra Small High Side Load Switch

**BUS1DJC0GWZ BUS1DJC3GWZ**

## General Description

BUS1DJC0GWZ and BUS1DJC3GWZ are low ON-Resistance high-side power switch P-channel MOSFETs. It comes in ultra-small package for portable digital applications. This switch IC operates on low input voltages ranging from 1.1V to 5.0V and exhibits a typical ON-resistance of 63 mΩ at 3.3V. The turn ON time of the device can be controlled to avoid inrush current.

## Features

- P-MOSFET high-side load switch
- Low input voltage
- Ultra low bias current
- Ultra low standby current
- Built-in discharge circuit
- Built-in soft start circuit
- Built-in short circuit protection
- Input logic : Active-High
- Ultra small package
- ESD protection

## Applications

- Digital cameras
- Mobile phones
- Smart phones
- Portable devices
- Digital video cameras

## Typical Application Circuits

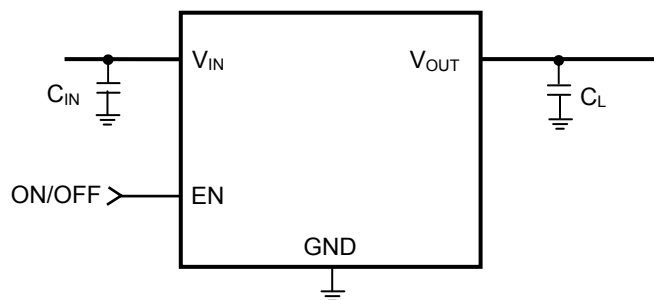

Figure 1. Typical Application Circuits

## Key Specifications

■ Input Voltage Range:	1.1V to 5.0V
■ R <sub>ON</sub> (at V <sub>IN</sub> =1.2V):	140mΩ (Typ)
■ R <sub>ON</sub> (at V <sub>IN</sub> =3.3V):	63mΩ (Typ)
■ Bias Current:	0.35μA(Typ)
■ Standby Current:	0.01μA (Typ)
■ Operating Temperature Range:	-30°C to +85°C

## Package

UCSP30L1

W(Typ) x D(Typ) x H(Max)  
0.8mm x 0.8mm x 0.35mm

Pin Configurations

B	EN	GND
A	V <sub>IN</sub>	V <sub>OUT</sub>
	2	1

Top View

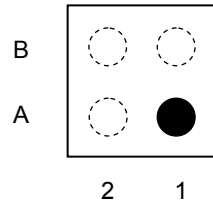

Top View

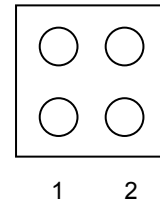

Bottom View

Figure 2. Pin Configuration

Pin Descriptions

Pin No.	Pin Name	Pin Function
A1	V <sub>OUT</sub>	Switch output
A2	V <sub>IN</sub>	Switch input
B1	GND	Ground
B2	EN	Enable input

Block Diagram

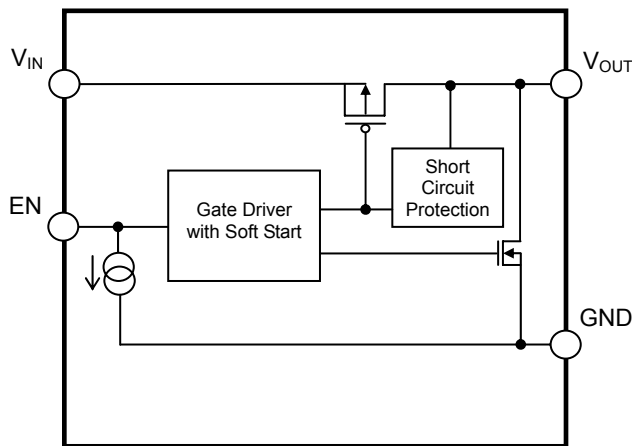

Figure 3. Block Diagram

**Absolute Maximum Ratings** (Ta = 25°C)

Parameter	Symbol	Rating	Unit
Switch Input Voltage	V <sub>IN</sub>	-0.3 to +5.5	V
Switch Output Voltage	V <sub>OUT</sub>	-0.3 to V <sub>IN</sub> +0.3	V
Enable Input Voltage	V <sub>EN</sub>	-0.3 to +5.5	V
Power Dissipation	P <sub>d</sub>	0.41 <sup>(Note 1)</sup>	W
Operating Temperature Range	Topr	-30 to +85	°C
Storage Temperature Range	Tstg	-55 to +125	°C
Junction Temperature	Tjmax	125	°C

(Note 1) Derate by 4.1mW/°C when operating above 25°C. (When mounted on a 9 layer glass-epoxy board with 63mm x 55mm x 1.6mm dimension.)  
**Caution:** Operating the IC over the absolute maximum ratings may damage the IC. The damage can either be a short circuit between pins or an open circuit between pins and the internal circuitry. Therefore, it is important to consider circuit protection measures, such as adding a fuse, in case the IC is operated over the absolute maximum ratings.

**Recommended Operating Conditions** (Ta= -30°C to +85°C)

Parameter	Symbol	Min	Typ	Max	Unit
Switch Input Voltage	V <sub>IN</sub>	1.1	-	5.0	V
Output Current	I <sub>OUT</sub>	-	-	2 <sup>(Note 2)</sup>	A

(Note 2) Not to exceed Pd and ASO.

**Electrical Characteristics** (Unless otherwise specified, V<sub>IN</sub>=3.3V, V<sub>EN</sub>=3.3V, Ta=25°C)

Parameter	Symbol	Min	Typ	Max	Unit	Conditions
Operating Current	I <sub>IN</sub>	-	0.35	1	µA	V <sub>EN</sub> =3.3V, I <sub>OUT</sub> =0A
OFF Supply Current	I <sub>IN_OFF</sub>	-	0.01	1	µA	V <sub>EN</sub> =0V, V <sub>OUT</sub> =OPEN
Leakage Current	I <sub>IN_Leak</sub>	-	0.01	1	µA	V <sub>EN</sub> =0V, V <sub>OUT</sub> =0V
ON-Resistance 1	R <sub>ON1</sub>	-	140	245	mΩ	V <sub>IN</sub> =1.2V
ON-Resistance 2	R <sub>ON2</sub>	-	80	125	mΩ	V <sub>IN</sub> =1.8V
ON-Resistance 3	R <sub>ON3</sub>	-	63	85	mΩ	V <sub>IN</sub> =3.3V
ON-Resistance 4	R <sub>ON4</sub>	-	58	80	mΩ	V <sub>IN</sub> =5.0V
EN High Voltage	V <sub>EN_High</sub>	0.85	-	5.0	V	
EN Low Voltage	V <sub>EN_Low</sub>	-0.3	-	0.4	V	
EN Bias Current	I <sub>EN</sub>	-	0.7	1.5	µA	V <sub>EN</sub> =3.3V
Discharge ON-Resistance	R <sub>ON_DIS</sub>	50	80	110	Ω	V <sub>EN</sub> =0V

**BUS1DJC0GWZ**

Parameter	Symbol	Min	Typ	Max	Unit	Conditions
Turn-ON Time 1	t <sub>ON1</sub>	-	32	-	µsec	V <sub>IN</sub> =1.2V, R <sub>L</sub> =510Ω, C <sub>L</sub> =0.1µF
Turn-ON Time 2	t <sub>ON2</sub>	-	12	-	µsec	V <sub>IN</sub> =3.3V, R <sub>L</sub> =510Ω, C <sub>L</sub> =0.1µF
Turn-OFF Time	t <sub>OFF</sub>	-	25	-	µsec	V <sub>IN</sub> =3.3V, R <sub>L</sub> =510Ω, C <sub>L</sub> =0.1µF

**BUS1DJC3GWZ**

Parameter	Symbol	Min	Typ	Max	Unit	Conditions
Turn-ON Time 1	t <sub>ON1</sub>	-	510	-	µsec	V <sub>IN</sub> =1.2V, R <sub>L</sub> =510Ω, C <sub>L</sub> =0.1µF
Turn-ON Time 2	t <sub>ON2</sub>	-	190	-	µsec	V <sub>IN</sub> =3.3V, R <sub>L</sub> =510Ω, C <sub>L</sub> =0.1µF
Turn-OFF Time	t <sub>OFF</sub>	-	25	-	µsec	V <sub>IN</sub> =3.3V, R <sub>L</sub> =510Ω, C <sub>L</sub> =0.1µF

Measurement Circuit

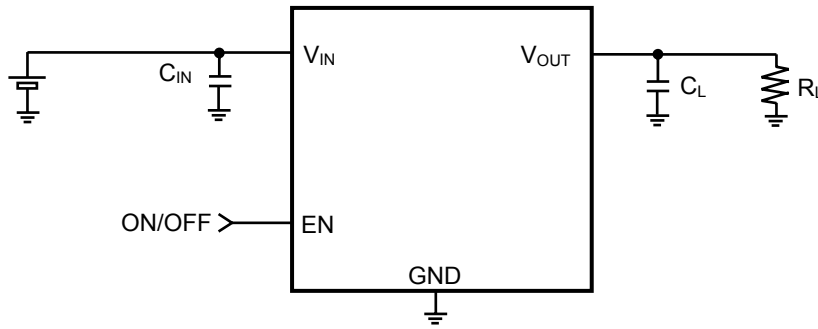

Figure 4. Measurement Circuit

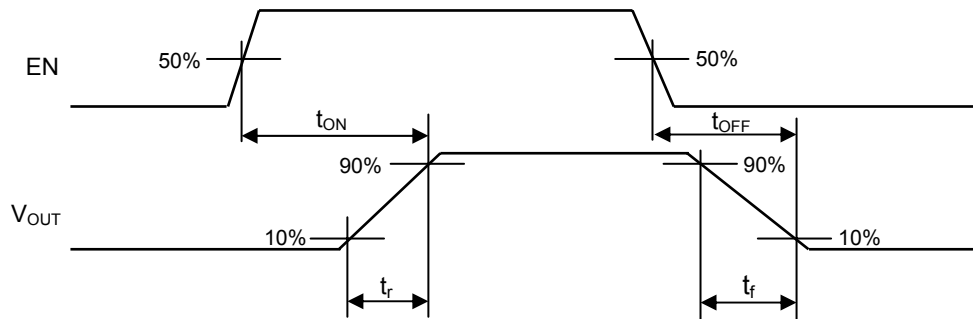

Figure 5. Timing Diagram

**Typical Performance Curves**

(Unless otherwise specified,  $T_a=25^\circ\text{C}$ ,  $V_{EN}=3.3\text{V}$ ,  $V_{IN}=3.3\text{V}$ )

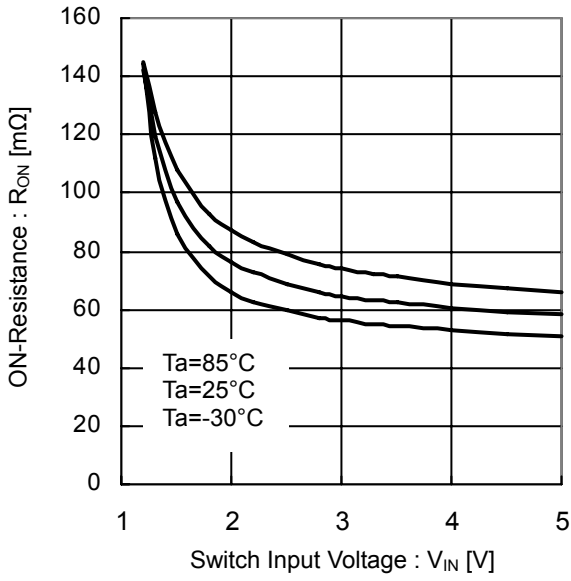

Figure 6. ON-Resistance vs Switch Input Voltage

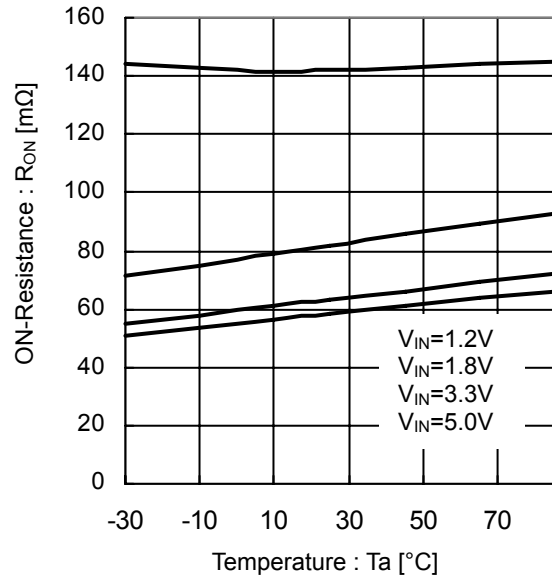

Figure 7. ON-Resistance vs Temperature

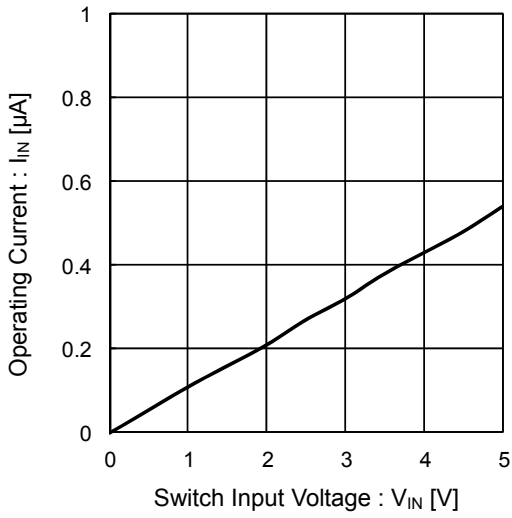

Figure 8. Operating Current vs Switch Input Voltage

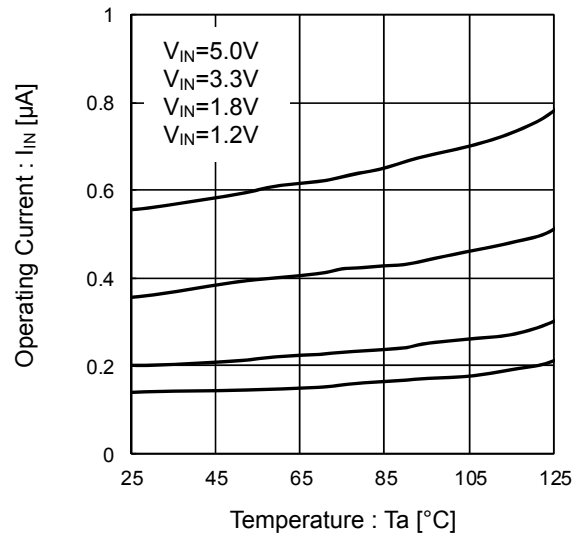

Figure 9. Operating Current vs Temperature

Typical Performance Curves - continued

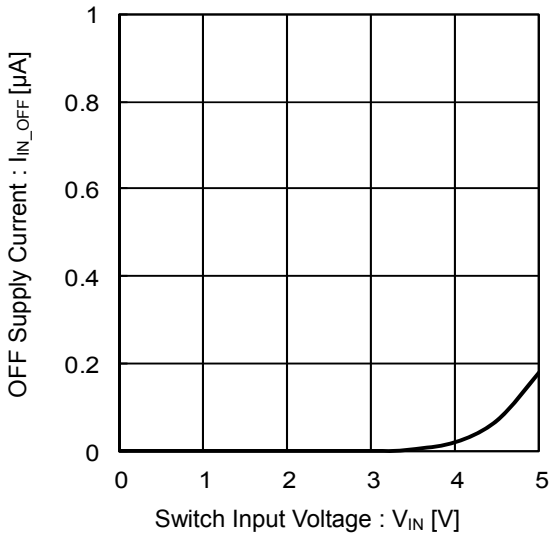

Figure 10. OFF Supply Current vs Switch Input Voltage ( $V_{EN}=0V$ )

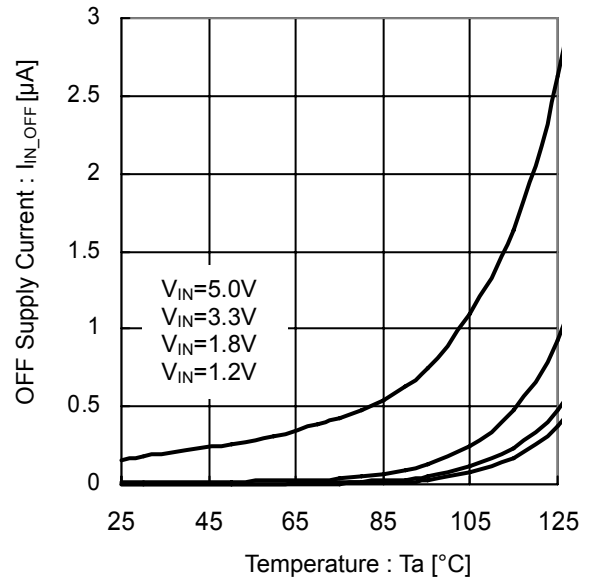

Figure 11. OFF Supply Current vs Temperature ( $V_{EN}=0V$ )

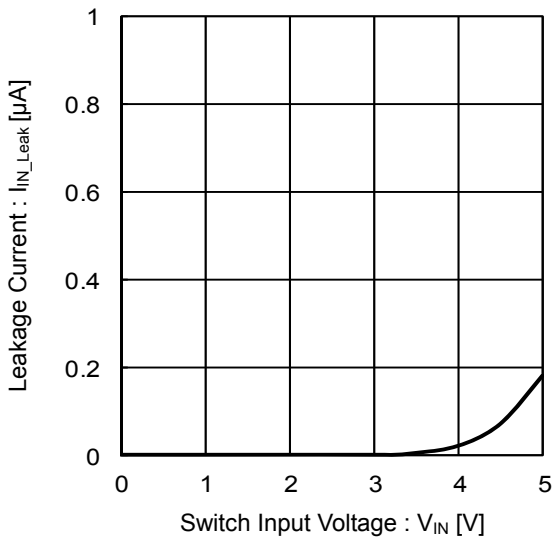

Figure 12. Leakage Current vs Switch Input Voltage ( $V_{EN}=0V, V_{OUT}=0V$ )

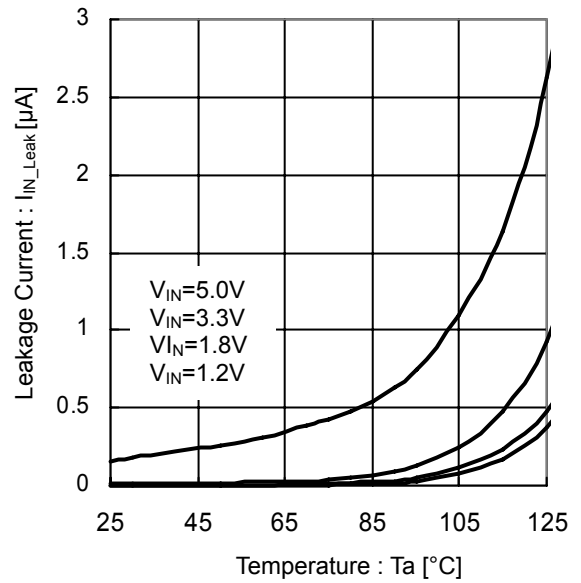

Figure 13. Leakage Current vs Temperature ( $V_{EN}=0V, V_{OUT}=0V$ )

Typical Performance Curves – continued

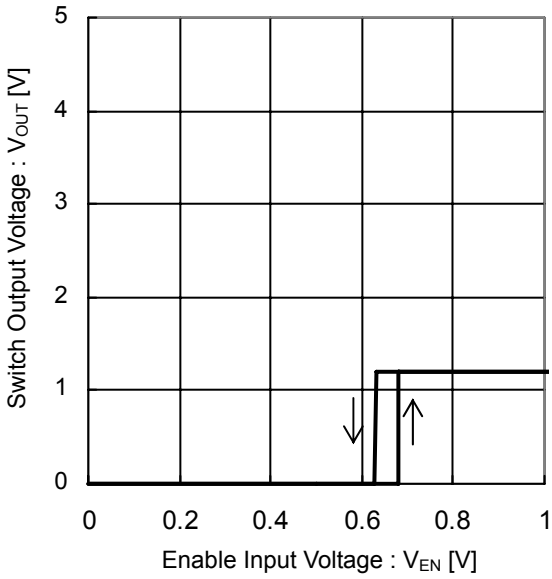

Figure 14. Switch Output Voltage vs Enable Input Voltage ( $V_{IN}=1.2V$ )

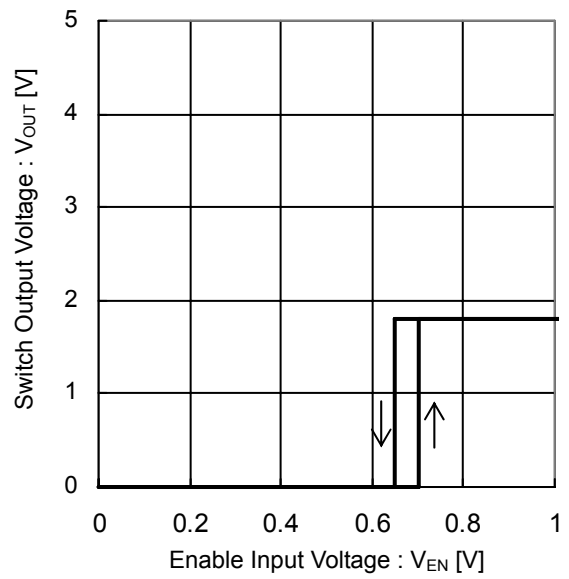

Figure 15. Switch Output Voltage vs Enable Input Voltage ( $V_{IN}=1.8V$ )

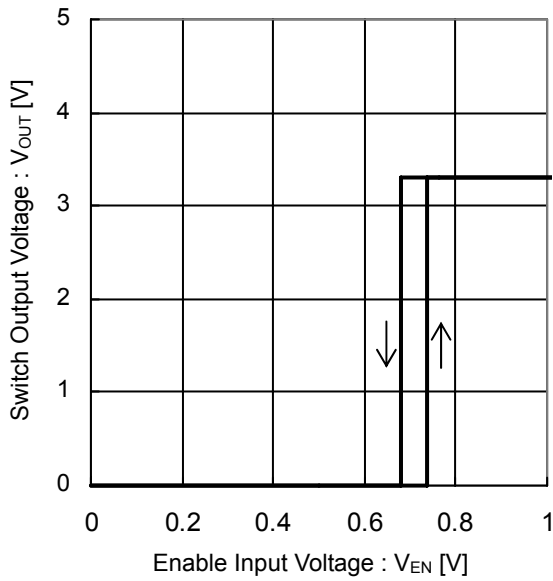

Figure 16. Switch Output Voltage vs Enable Input Voltage ( $V_{IN}=3.3V$ )

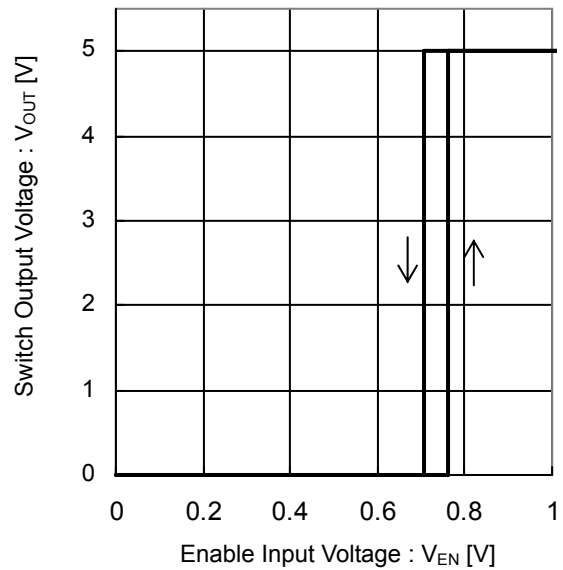

Figure 17. Switch Output Voltage vs Enable Input Voltage ( $V_{IN}=5.0V$ )

Typical Performance Curves – continued

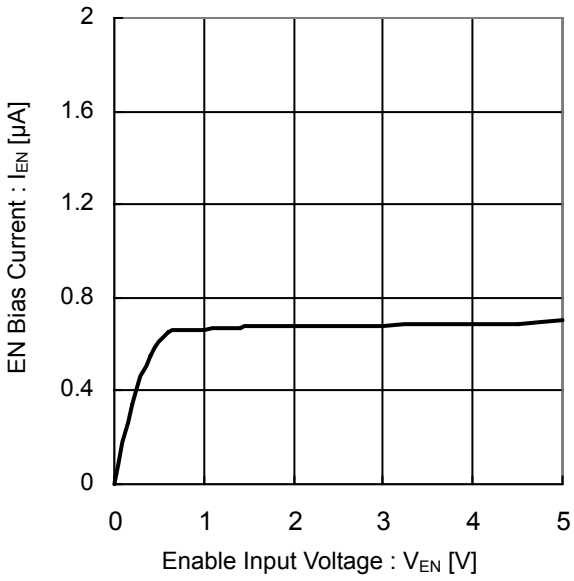

Figure 18. EN Bias Current vs Enable Input Voltage

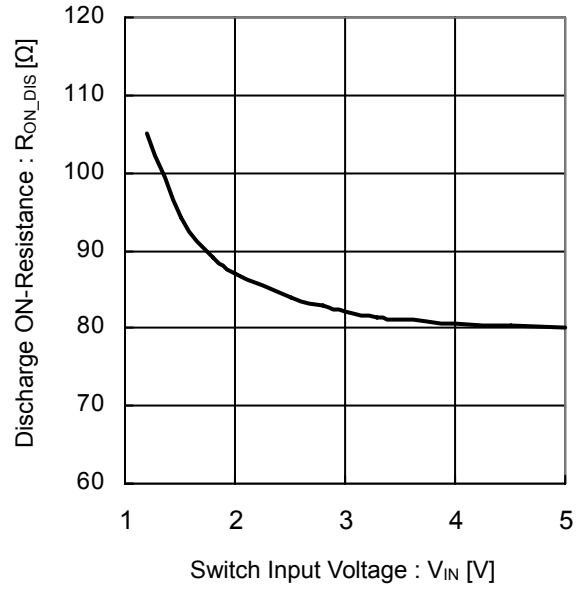

Figure 19. Discharge ON-Resistance vs Switch Input Voltage

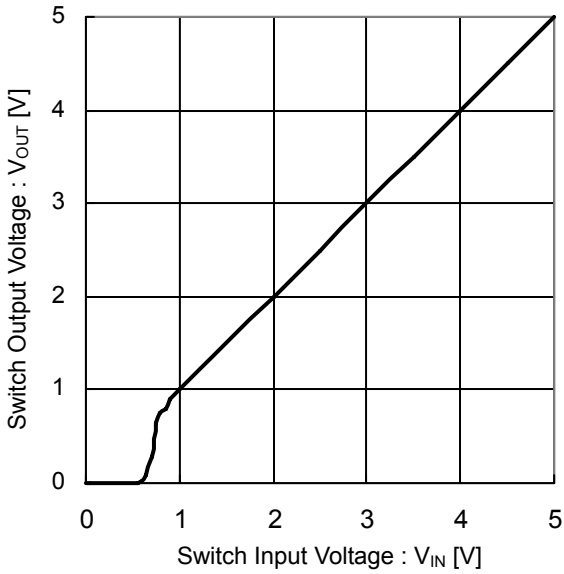

Figure 20. Switch Output Voltage vs Switch Input Voltage ( $V_{EN}=3.3V$ )

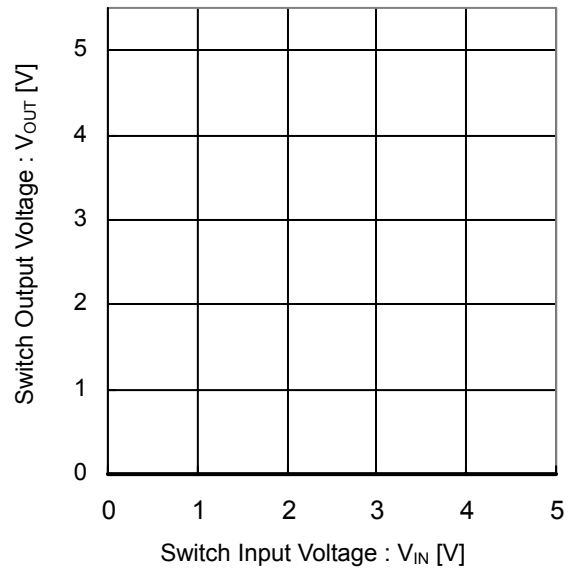

Figure 21. Switch Output Voltage vs Switch Input Voltage ( $V_{EN}=0V$ )

Typical Performance Curves – continued

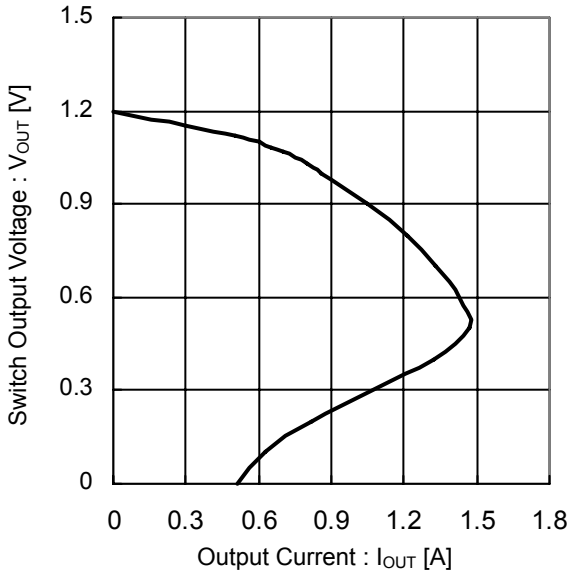

Figure 22. Switch Output Voltage vs Output Current ( $V_{IN}=1.2V$ )

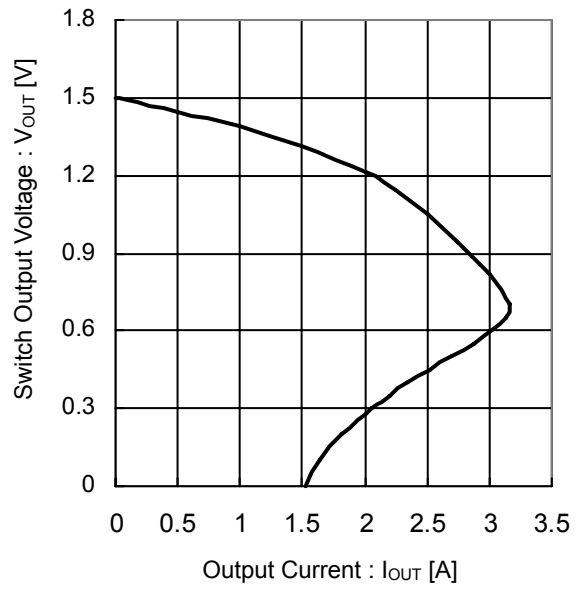

Figure 23. Switch Output Voltage vs Output Current ( $V_{IN}=1.5V$ )

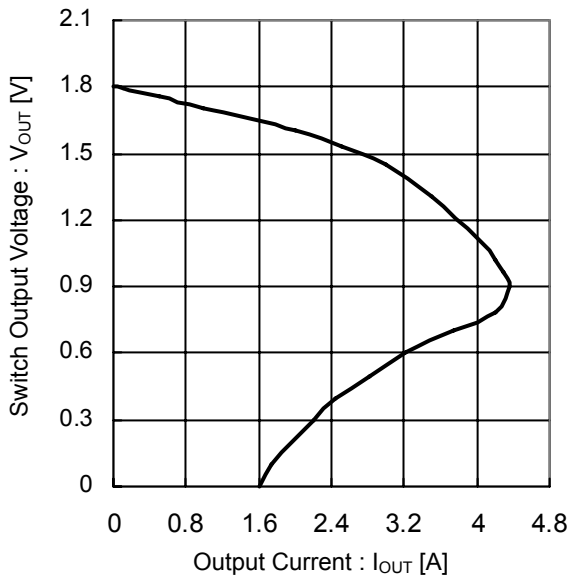

Figure 24. Switch Output Voltage vs Output Current ( $V_{IN}=1.8V$ )

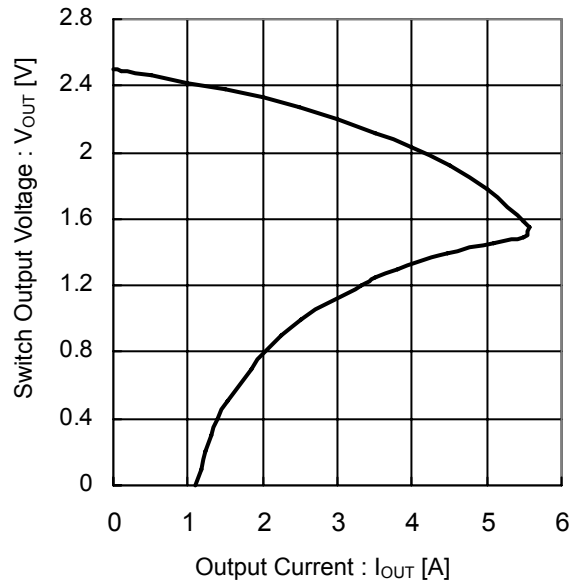

Figure 25. Switch Output Voltage vs Output Current ( $V_{IN}=2.5V$ )

Typical Performance Curves – continued

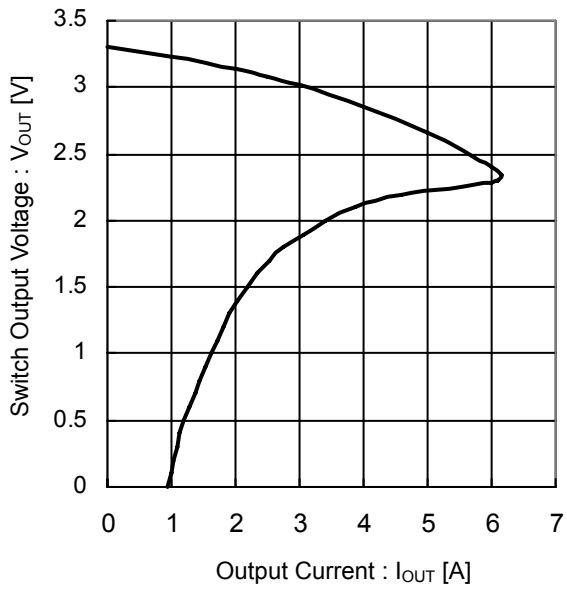

Figure 26. Switch Output Voltage vs Output Current ( $V_{IN}=3.3V$ )

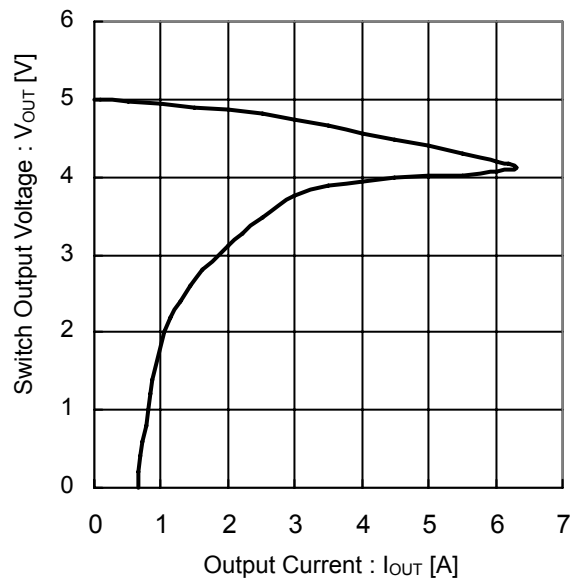

Figure 27. Switch Output Voltage vs Output Current ( $V_{IN}=5.0V$ )

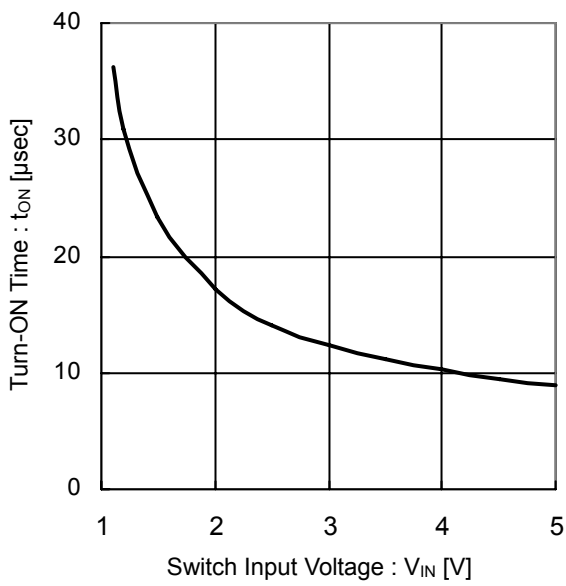

Figure 28. Turn-ON Time vs Switch Input Voltage (BUS1DJC0GWZ)

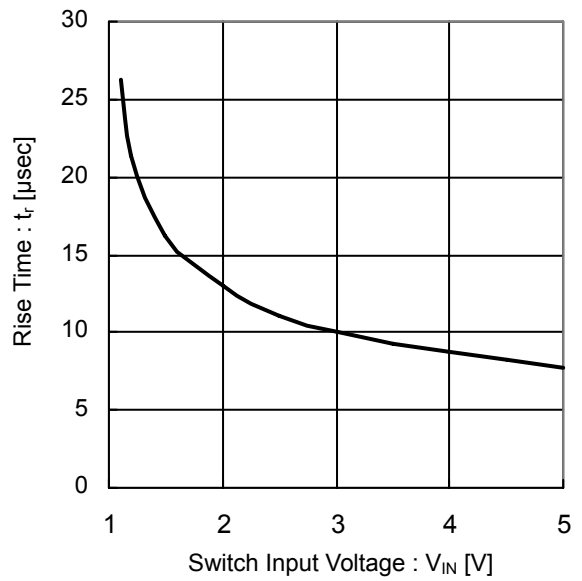

Figure 29. Rise Time vs Switch Input Voltage (BUS1DJC0GWZ)

Typical Performance Curves – continued

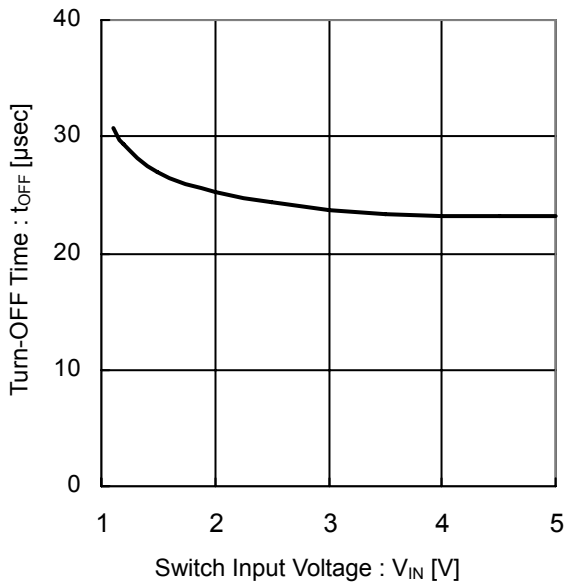

Figure 30. Turn-OFF Time vs Switch Input Voltage (BUS1DJC0GWZ)

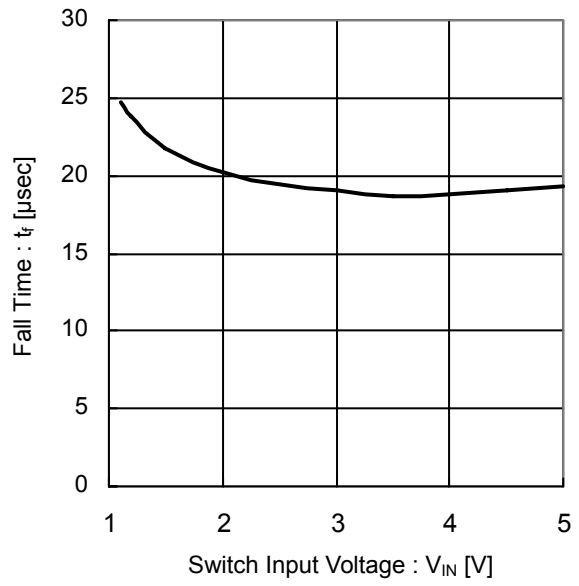

Figure 31. Fall Time vs Switch Input Voltage (BUS1DJC0GWZ)

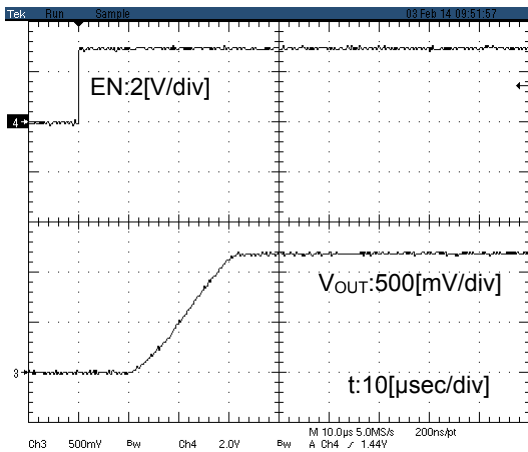

Figure 32. Turn ON Response 1 (BUS1DJC0GWZ V<sub>IN</sub>=1.2V)

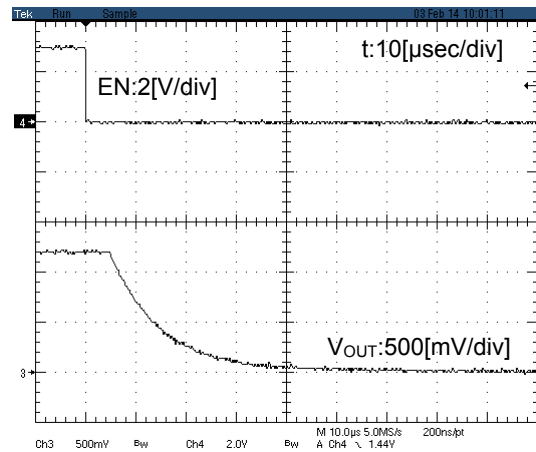

Figure 33. Turn OFF Response 1 (BUS1DJC0GWZ V<sub>IN</sub>=1.2V)

Typical Performance Curves – continued

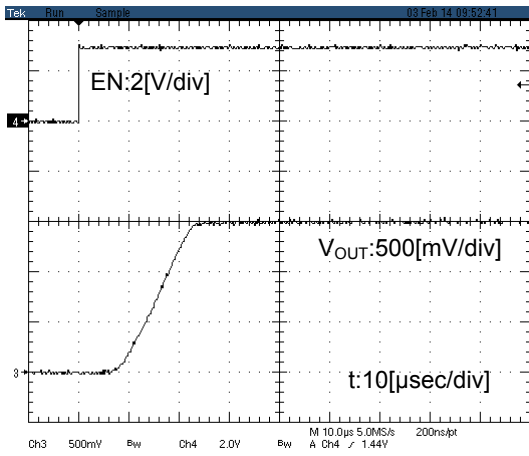

Figure 34. Turn ON Response 2  
(BUS1DJC0GWZ  $V_{IN}=1.5V$ )

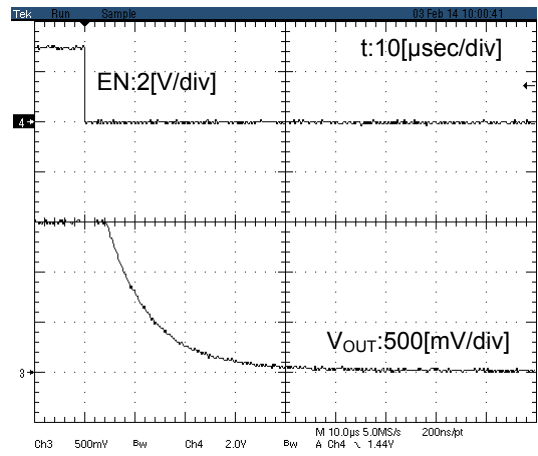

Figure 35. Turn OFF Response 2  
(BUS1DJC0GWZ  $V_{IN}=1.5V$ )

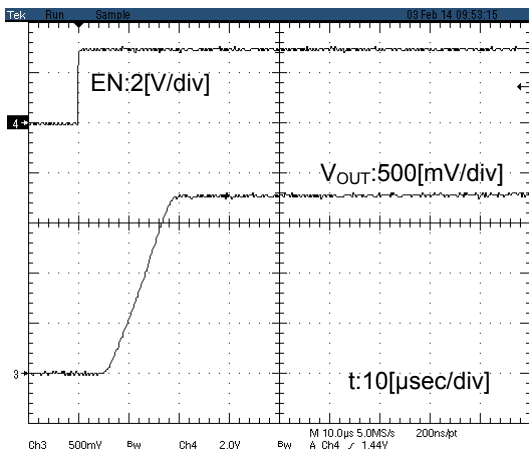

Figure 36. Turn ON Response 3  
(BUS1DJC0GWZ  $V_{IN}=1.8V$ )

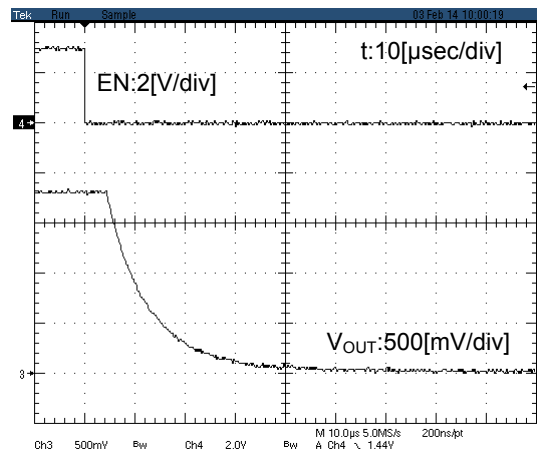

Figure 37. Turn OFF Response 3  
(BUS1DJC0GWZ  $V_{IN}=1.8V$ )

Typical Performance Curves – continued

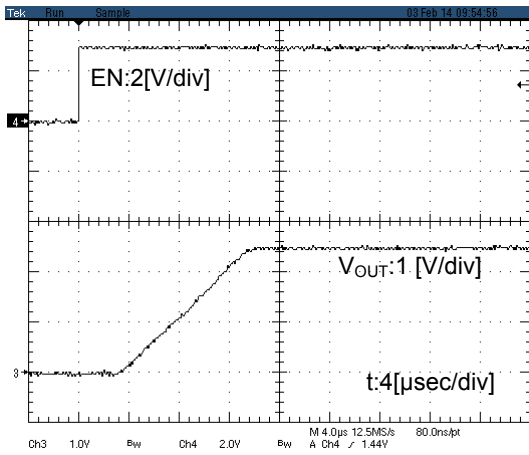

Figure 38. Turn ON Response 4  
(BUS1DJC0GWZ  $V_{IN}=2.5V$ )

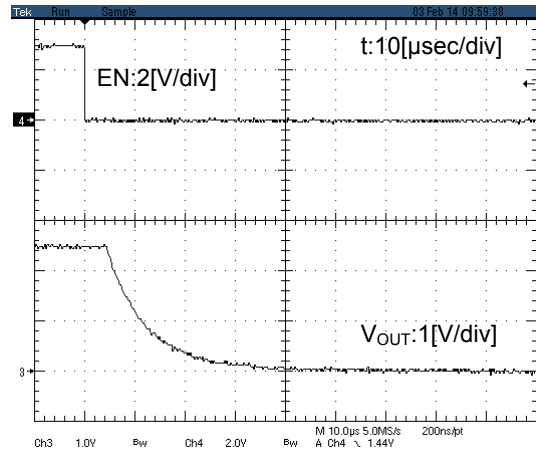

Figure 39. Turn OFF Response 4  
(BUS1DJC0GWZ  $V_{IN}=2.5V$ )

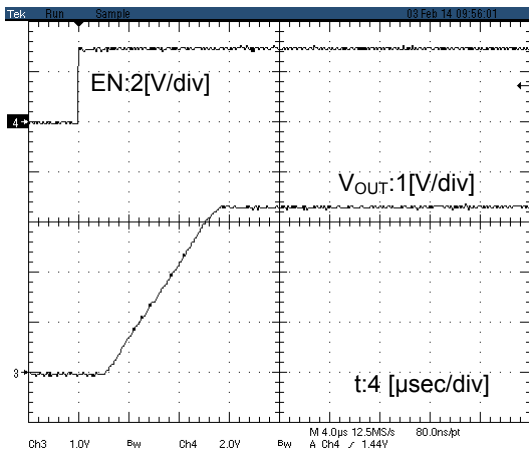

Figure 40. Turn ON Response 5  
(BUS1DJC0GWZ  $V_{IN}=3.3V$ )

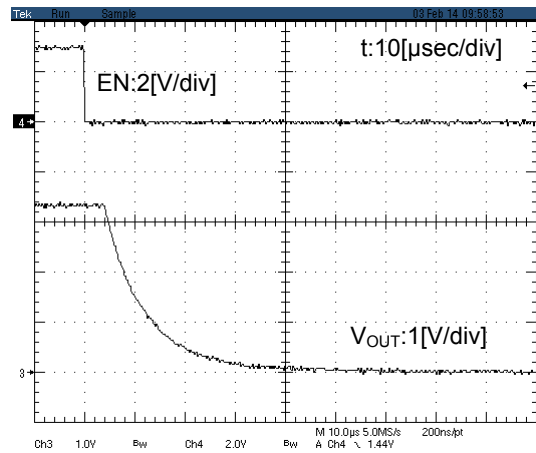

Figure 41. Turn OFF Response 5  
(BUS1DJC0GWZ  $V_{IN}=3.3V$ )

Typical Performance Curves – continued

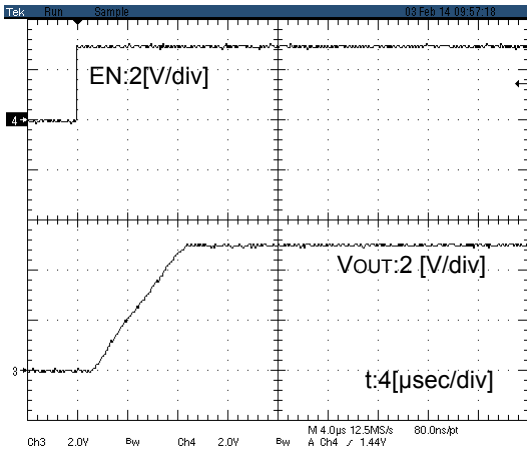

Figure.42 Turn on response 6  
(BUS1DJC0GWZ VIN=5.0V)

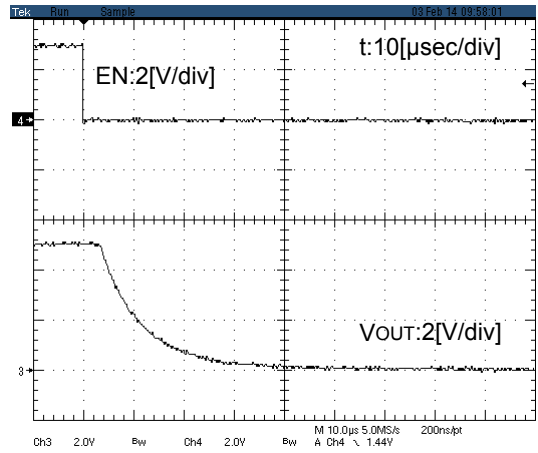

Figure.43 Turn off response 6  
(BUS1DJC0GWZ VIN=5.0V)

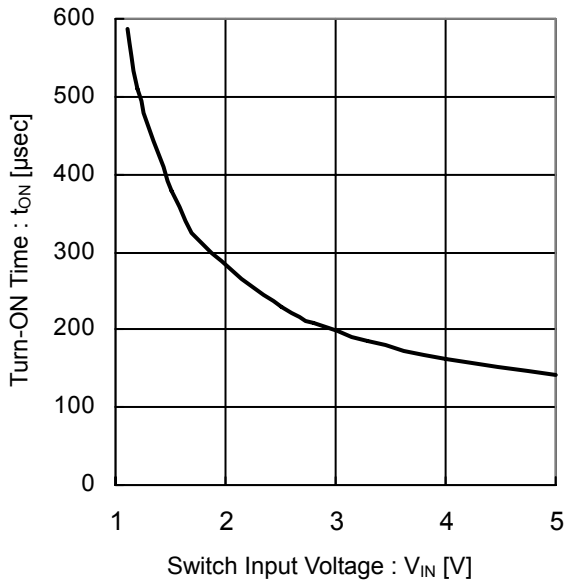

Figure 44. Turn-ON Time vs Switch Input Voltage  
(BUS1DJC3GWZ)

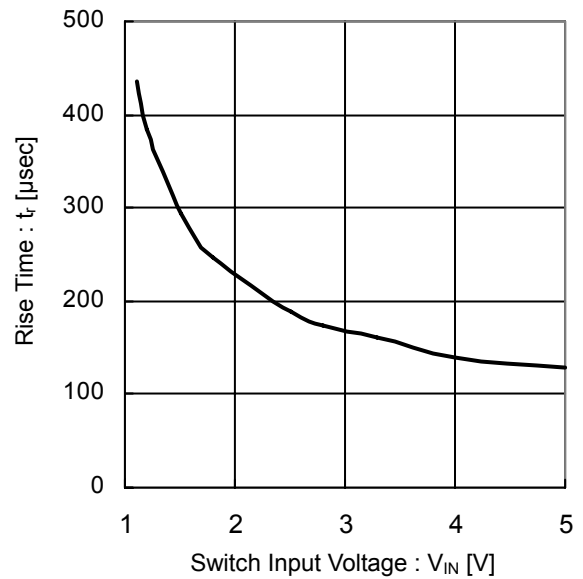

Figure 45. Rise Time vs Switch Input Voltage  
(BUS1DJC3GWZ)

Typical Performance Curves – continued

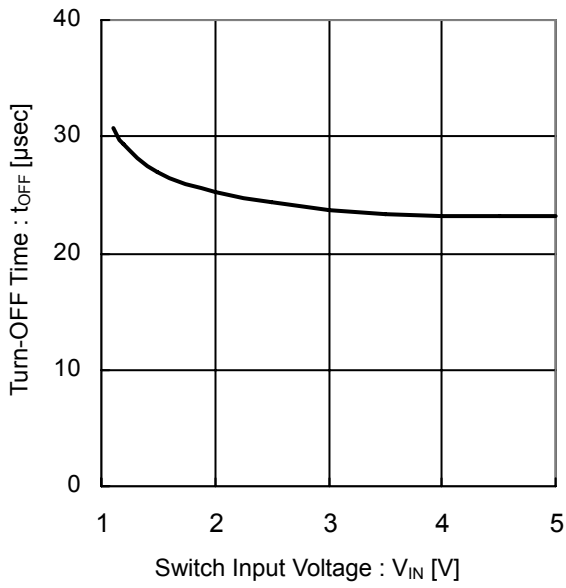

Figure 46. Turn-OFF Time vs Switch Input Voltage (BUS1DJC3GWZ)

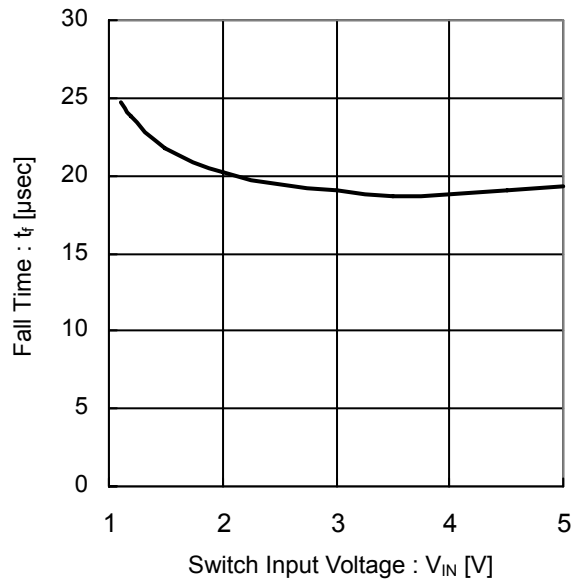

Figure 47. Fall Time vs Switch Input Voltage (BUS1DJC3GWZ)

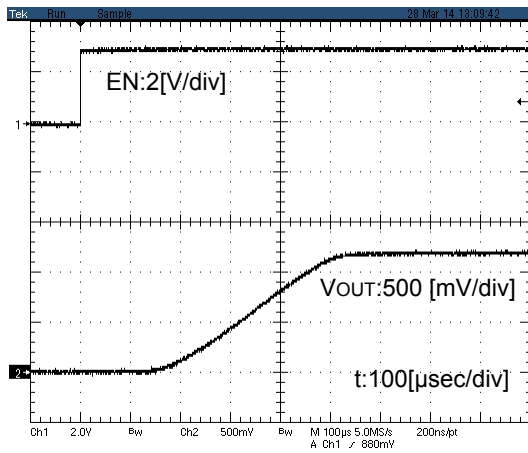

Figure.48 Turn on response 7 (BUS1DJC3GWZ VIN=1.2V)

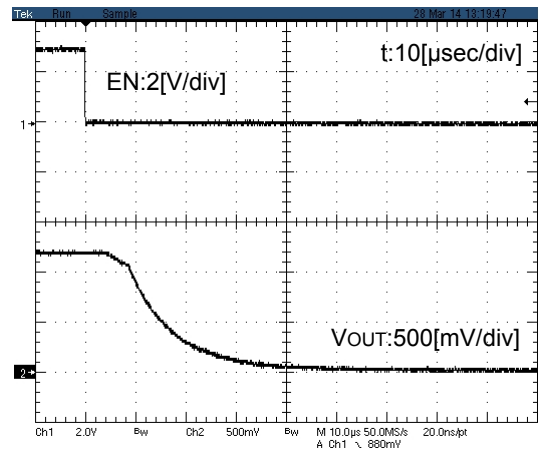

Figure.49 Turn off response 7 (BUS1DJC3GWZ VIN=1.2V)

Typical Performance Curves – continued

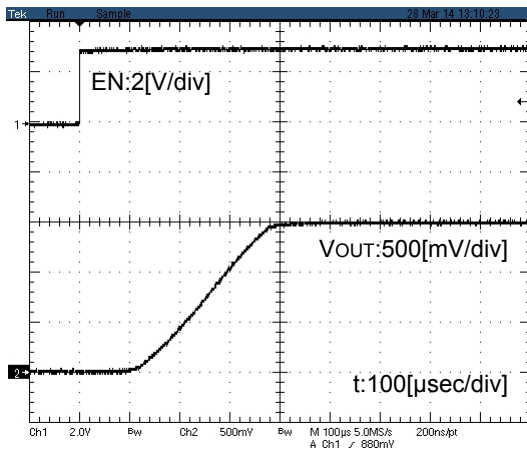

Figure.50 Turn on response 8  
(BUS1DJC3GWZ VIN=1.5V)

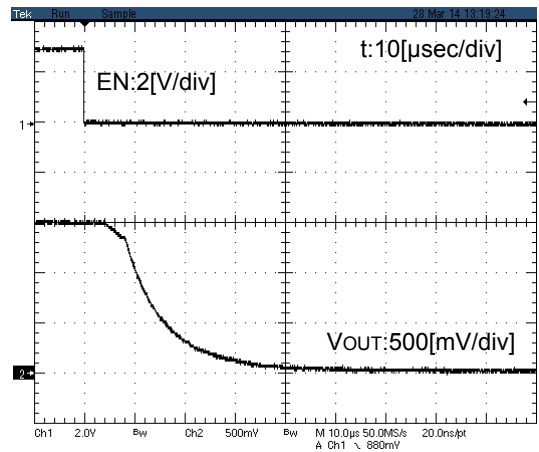

Figure.51 Turn off response 8  
(BUS1DJC3GWZ VIN=1.5V)

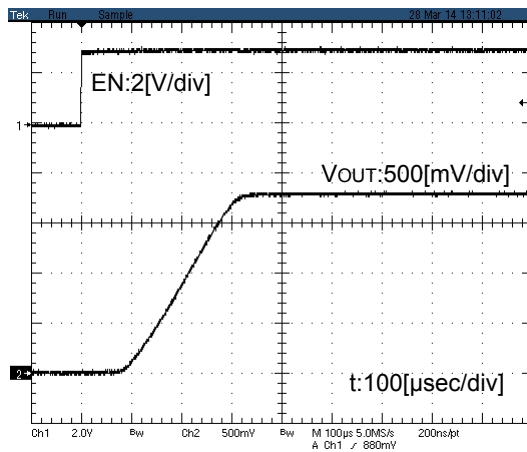

Figure.52 Turn on response 9  
(BUS1DJC3GWZ VIN=1.8V)

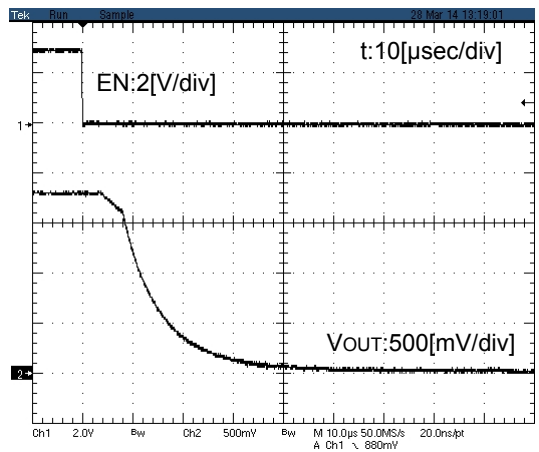

Figure.53 Turn off response 9  
(BUS1DJC3GWZ VIN=1.8V)

Typical Performance Curves – continued

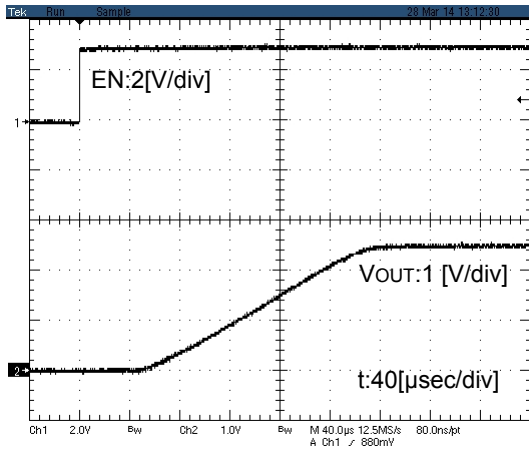

Figure.54 Turn on response 10  
(BUS1DJC3GWZ VIN=2.5V)

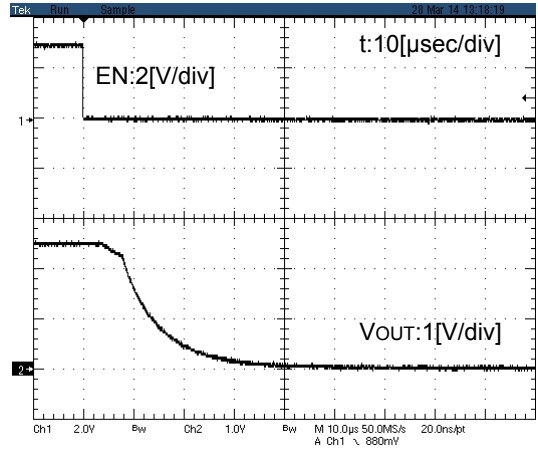

Figure.55 Turn off response 10  
(BUS1DJC3GWZ VIN=2.5V)

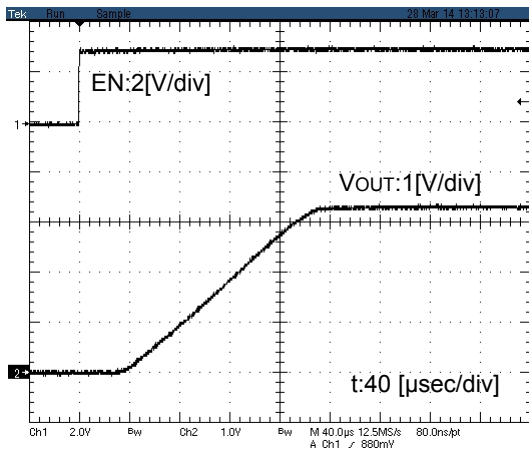

Figure.56 Turn on response 11  
(BUS1DJC3GWZ VIN=3.3V)

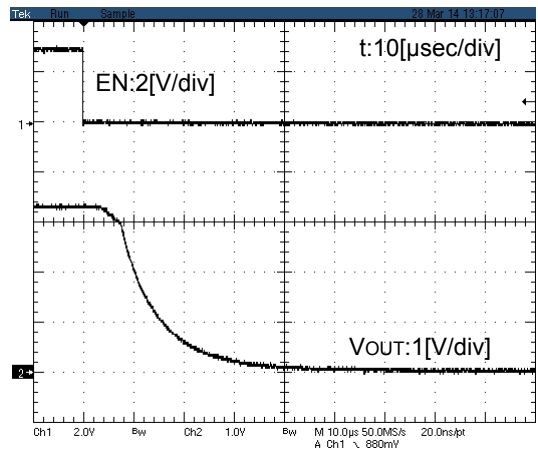

Figure.57 Turn off response 11  
(BUS1DJC3GWZ VIN=3.3V)

Typical Performance Curves – continued

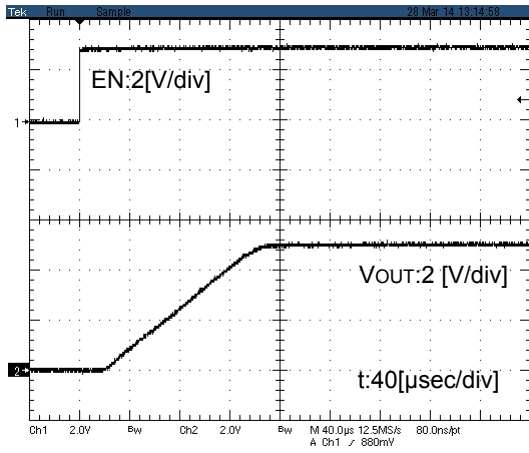

Figure.58 Turn on response 12  
(BUS1DJC3GWZ VIN=5V)

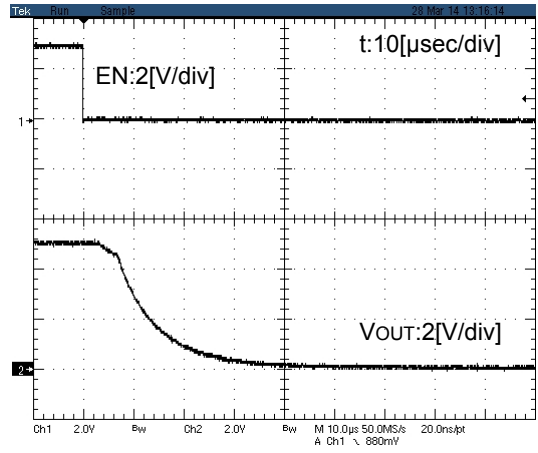

Figure.59 Turn off response 12  
(BUS1DJC3GWZ VIN=5V)

**Application Information**

It is recommended that an input bypass/decoupling capacitor (over 0.1μF) is placed near the IC between the V<sub>IN</sub> and GND pins. The capacitor between V<sub>IN</sub> and GND pins is necessary when there is high impedance on the power supply or if the power trace is long. Larger capacitance value (0.1μF to 100μF) would result to better line regulation and will improve power characteristics during load change. However, IC operation must be confirmed by mounting the device on an actual application board.

**Power Dissipation**

An estimation of heat reduction characteristics and internal power consumption of the IC are shown below. Use these for reference. It is recommended to measure Pd on a set board since power dissipation changes substantially according to the implementation conditions (board size, board thickness, metal wiring rate, number of layers and through holes, etc.). Exceeding the power dissipation of IC may lead to degradation of the original IC performance, such as reduction in current capability of the device. It is recommended to provide sufficient margin within the power dissipation rating for usage.

Calculation of the internal power consumption of IC (P)

$$P = R_{ON} \times I_{OUT} \times I_{OUT}$$

Where:

R<sub>ON</sub> is the ON-state resistance

I<sub>OUT</sub> is the Average output current

○ Measurement Conditions

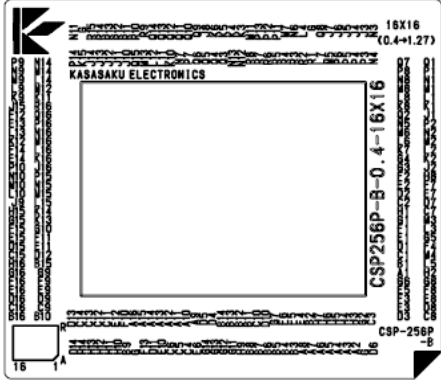
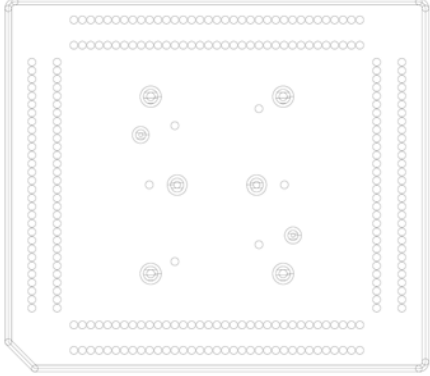
Layout of Board for Measurement	Evaluation Board	
	 <p style="text-align: center;">Top Layer (Top View)</p>	 <p style="text-align: center;">Bottom Layer (Top View)</p>
Measurement State	With board implemented (Wind speed 0 m/s)	
Board Material	Glass epoxy resin (9 layers)	
Board Size	63 mm x 55 mm x 1.6 mm	
Wiring Rate	Top layer	Metal (GND) wiring rate: Approx. 0%
	Bottom layer	Metal (GND) wiring rate: Approx. 50%
Through Hole	Diameter 0.5mm x 6 holes	
Power Dissipation	0.41W	
Thermal Resistance	θ <sub>ja</sub> =243.9°C/W	

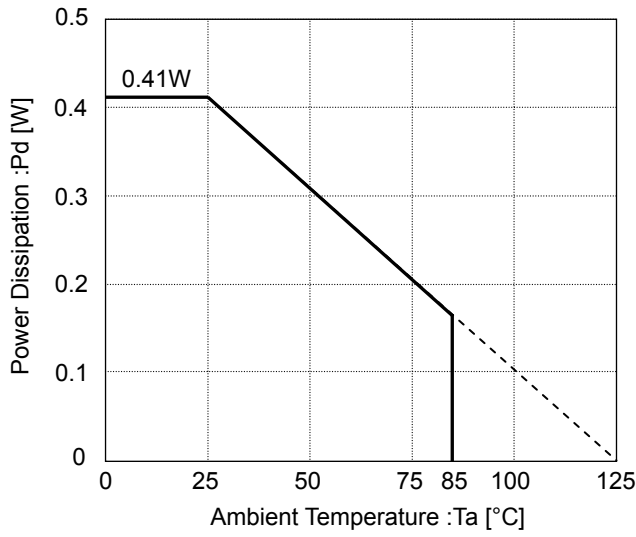

\* Please design the margin so that P is less than Pd (P < Pd) within the usage temperature range

Figure 60. UCSP30L1(BUS1DJC0GWZ/ BUS1DJC3GWZ) Power Dissipation Heat Reduction Characteristics (Reference)

I/O Equivalence Circuits

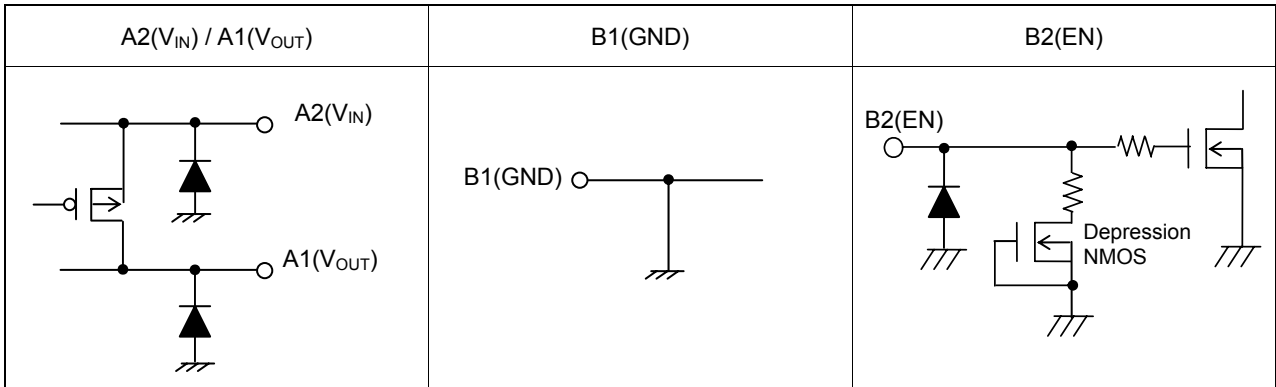

## Operational Notes

### 1. Reverse Connection of Power Supply

Connecting the power supply in reverse polarity can damage the IC. Take precautions against reverse polarity when connecting the power supply, such as mounting an external diode between the power supply and the IC's power supply terminals.

### 2. Power Supply Lines

Design the PCB layout pattern to provide low impedance supply lines. Separate the ground and supply lines of the digital and analog blocks to prevent noise in the ground and supply lines of the digital block from affecting the analog block. Furthermore, connect a capacitor to ground at all power supply pins. Consider the effect of temperature and aging on the capacitance value when using electrolytic capacitors.

### 3. Ground Voltage

Ensure that no pins are at a voltage below that of the ground pin at any time, even during transient condition.

### 4. Ground Wiring Pattern

When using both small-signal and large-current ground traces, the two ground traces should be routed separately but connected to a single ground at the reference point of the application board to avoid fluctuations in the small-signal ground caused by large currents. Also ensure that the ground traces of external components do not cause variations on the ground voltage. The ground lines must be as short and thick as possible to reduce line impedance.

### 5. Thermal Consideration

Should by any chance the power dissipation rating be exceeded the rise in temperature of the chip may result in deterioration of the properties of the chip. The absolute maximum rating of the Pd stated in this specification is when the IC is mounted on a glass epoxy board. In case of exceeding this absolute maximum rating, increase the board size and copper area to prevent exceeding the Pd rating.

### 6. Recommended Operating Conditions

These conditions represent a range within which the expected characteristics of the IC can be approximately obtained. The electrical characteristics are guaranteed under the conditions of each parameter.

### 7. Inrush Current

When power is first supplied to the IC, it is possible that the internal logic may be unstable and inrush current may flow instantaneously due to the internal powering sequence and delays, especially if the IC has more than one power supply. Therefore, give special consideration to power coupling capacitance, power wiring, width of ground wiring, and routing of connections.

### 8. Operation Under Strong Electromagnetic Field

Operating the IC in the presence of a strong electromagnetic field may cause the IC to malfunction.

### 9. Testing on Application Boards

When testing the IC on an application board, connecting a capacitor directly to a low-impedance output pin may subject the IC to stress. Always discharge capacitors completely after each process or step. The IC's power supply should always be turned OFF completely before connecting or removing it from the test setup during the inspection process. To prevent damage from static discharge, ground the IC during assembly and use similar precautions during transport and storage.

### 10. Inter-pin Short and Mounting Errors

Ensure that the direction and position are correct when mounting the IC on the PCB. Incorrect mounting may result in damaging the IC. Avoid nearby pins being shorted to each other especially to ground, power supply and output pin. Inter-pin shorts could be due to many reasons such as metal particles, water droplets (in very humid environment) and unintentional solder bridge deposited in between pins during assembly to name a few.

**Operational Notes – continued****11. Unused Input Terminals**

Input terminals of an IC are often connected to the gate of a MOS transistor. The gate has extremely high impedance and extremely low capacitance. If left unconnected, the electric field from the outside can easily charge it. The small charge acquired in this way is enough to produce a significant effect on the conduction through the transistor and cause unexpected operation of the IC. So unless otherwise specified, unused input terminals should be connected to the power supply or ground line.

**12. Regarding the Input Pin of the IC**

In the construction of this IC, P-N junctions are inevitably formed creating parasitic diodes or transistors. The operation of these parasitic elements can result in mutual interference among circuits, operational faults, or physical damage. Therefore, conditions which cause these parasitic elements to operate, such as applying a voltage to an input pin lower than the ground voltage should be avoided. Furthermore, do not apply a voltage to the input pins when no power supply voltage is applied to the IC. Even if the power supply voltage is applied, make sure that the input pins have voltages within the values specified in the electrical characteristics of this IC.

**13. Ceramic Capacitor**

When using a ceramic capacitor, determine the dielectric constant considering the change of capacitance with temperature and the decrease in nominal capacitance due to DC bias and others.

**14. Area of Safe Operation (ASO)**

Operate the IC such that the output voltage, output current, and power dissipation are all within the Area of Safe Operation (ASO).

Ordering Information

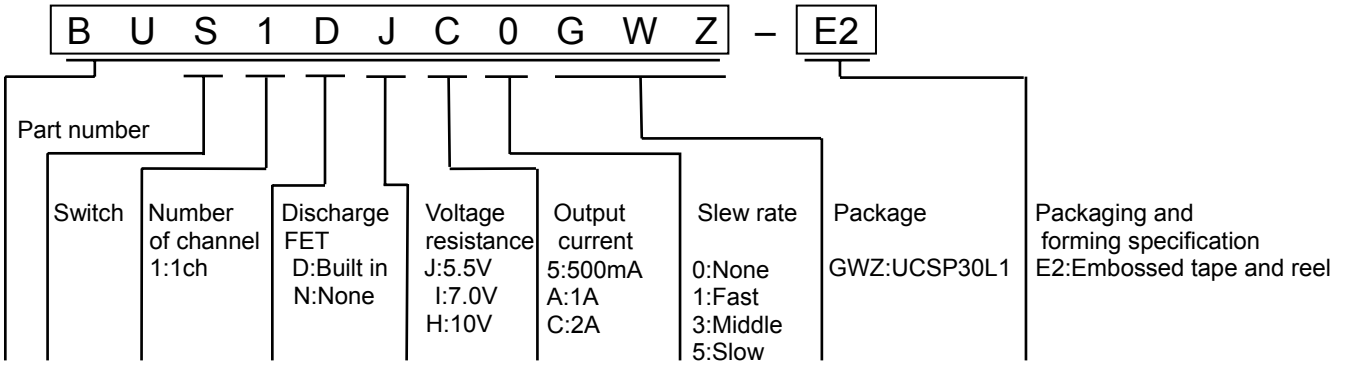

Marking Diagram

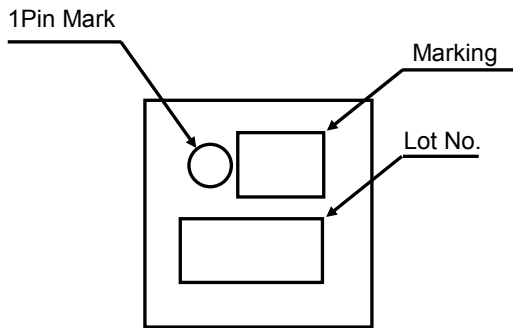

Part No.	Marking
BUS1DJC0GWZ	GV
BUS1DJC3GWZ	GX

Physical Dimension, Tape and Reel Information

UCSP30L1(BUS1DJC0GWZ / BUS1DJC3GWZ)

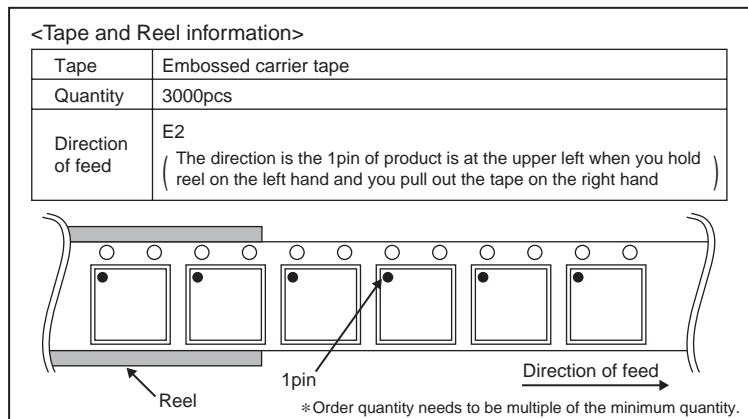
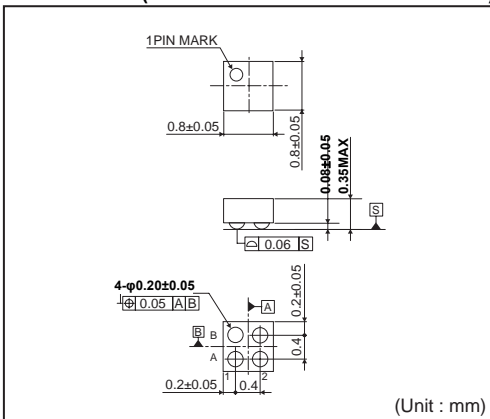

Revision History

Date	Revision	Changes
11.Mar.2014	001	New Release
8.Apr.2014	002	Added BUS1DJC3GWZ

# Notice

## Precaution on using ROHM Products

- Our Products are designed and manufactured for application in ordinary electronic equipments (such as AV equipment, OA equipment, telecommunication equipment, home electronic appliances, amusement equipment, etc.). If you intend to use our Products in devices requiring extremely high reliability (such as medical equipment <sup>(Note 1)</sup>, transport equipment, traffic equipment, aircraft/spacecraft, nuclear power controllers, fuel controllers, car equipment including car accessories, safety devices, etc.) and whose malfunction or failure may cause loss of human life, bodily injury or serious damage to property ("Specific Applications"), please consult with the ROHM sales representative in advance. Unless otherwise agreed in writing by ROHM in advance, ROHM shall not be in any way responsible or liable for any damages, expenses or losses incurred by you or third parties arising from the use of any ROHM's Products for Specific Applications.

(Note1) Medical Equipment Classification of the Specific Applications

JAPAN	USA	EU	CHINA
CLASS III	CLASS III	CLASS II b	CLASS III
CLASS IV		CLASS III	

- ROHM designs and manufactures its Products subject to strict quality control system. However, semiconductor products can fail or malfunction at a certain rate. Please be sure to implement, at your own responsibilities, adequate safety measures including but not limited to fail-safe design against the physical injury, damage to any property, which a failure or malfunction of our Products may cause. The following are examples of safety measures:
  - Installation of protection circuits or other protective devices to improve system safety
  - Installation of redundant circuits to reduce the impact of single or multiple circuit failure
- Our Products are designed and manufactured for use under standard conditions and not under any special or extraordinary environments or conditions, as exemplified below. Accordingly, ROHM shall not be in any way responsible or liable for any damages, expenses or losses arising from the use of any ROHM's Products under any special or extraordinary environments or conditions. If you intend to use our Products under any special or extraordinary environments or conditions (as exemplified below), your independent verification and confirmation of product performance, reliability, etc. prior to use, must be necessary:
  - Use of our Products in any types of liquid, including water, oils, chemicals, and organic solvents
  - Use of our Products outdoors or in places where the Products are exposed to direct sunlight or dust
  - Use of our Products in places where the Products are exposed to sea wind or corrosive gases, including Cl<sub>2</sub>, H<sub>2</sub>S, NH<sub>3</sub>, SO<sub>2</sub>, and NO<sub>2</sub>
  - Use of our Products in places where the Products are exposed to static electricity or electromagnetic waves
  - Use of our Products in proximity to heat-producing components, plastic cords, or other flammable items
  - Sealing or coating our Products with resin or other coating materials
  - Use of our Products without cleaning residue of flux (even if you use no-clean type fluxes, cleaning residue of flux is recommended); or Washing our Products by using water or water-soluble cleaning agents for cleaning residue after soldering
  - Use of the Products in places subject to dew condensation
- The Products are not subject to radiation-proof design.
- Please verify and confirm characteristics of the final or mounted products in using the Products.
- In particular, if a transient load (a large amount of load applied in a short period of time, such as pulse. is applied, confirmation of performance characteristics after on-board mounting is strongly recommended. Avoid applying power exceeding normal rated power; exceeding the power rating under steady-state loading condition may negatively affect product performance and reliability.
- De-rate Power Dissipation (Pd) depending on Ambient temperature (Ta). When used in sealed area, confirm the actual ambient temperature.
- Confirm that operation temperature is within the specified range described in the product specification.
- ROHM shall not be in any way responsible or liable for failure induced under deviant condition from what is defined in this document.

## Precaution for Mounting / Circuit board design

- When a highly active halogenous (chlorine, bromine, etc.) flux is used, the residue of flux may negatively affect product performance and reliability.
- In principle, the reflow soldering method must be used on a surface-mount products, the flow soldering method must be used on a through hole mount products. If the flow soldering method is preferred on a surface-mount products, please consult with the ROHM representative in advance.

For details, please refer to ROHM Mounting specification

**Precautions Regarding Application Examples and External Circuits**

1. If change is made to the constant of an external circuit, please allow a sufficient margin considering variations of the characteristics of the Products and external components, including transient characteristics, as well as static characteristics.
2. You agree that application notes, reference designs, and associated data and information contained in this document are presented only as guidance for Products use. Therefore, in case you use such information, you are solely responsible for it and you must exercise your own independent verification and judgment in the use of such information contained in this document. ROHM shall not be in any way responsible or liable for any damages, expenses or losses incurred by you or third parties arising from the use of such information.

**Precaution for Electrostatic**

This Product is electrostatic sensitive product, which may be damaged due to electrostatic discharge. Please take proper caution in your manufacturing process and storage so that voltage exceeding the Products maximum rating will not be applied to Products. Please take special care under dry condition (e.g. Grounding of human body / equipment / solder iron, isolation from charged objects, setting of Ionizer, friction prevention and temperature / humidity control).

**Precaution for Storage / Transportation**

1. Product performance and soldered connections may deteriorate if the Products are stored in the places where:
  - [a] the Products are exposed to sea winds or corrosive gases, including Cl<sub>2</sub>, H<sub>2</sub>S, NH<sub>3</sub>, SO<sub>2</sub>, and NO<sub>2</sub>
  - [b] the temperature or humidity exceeds those recommended by ROHM
  - [c] the Products are exposed to direct sunshine or condensation
  - [d] the Products are exposed to high Electrostatic
2. Even under ROHM recommended storage condition, solderability of products out of recommended storage time period may be degraded. It is strongly recommended to confirm solderability before using Products of which storage time is exceeding the recommended storage time period.
3. Store / transport cartons in the correct direction, which is indicated on a carton with a symbol. Otherwise bent leads may occur due to excessive stress applied when dropping of a carton.
4. Use Products within the specified time after opening a humidity barrier bag. Baking is required before using Products of which storage time is exceeding the recommended storage time period.

**Precaution for Product Label**

QR code printed on ROHM Products label is for ROHM's internal use only.

**Precaution for Disposition**

When disposing Products please dispose them properly using an authorized industry waste company.

**Precaution for Foreign Exchange and Foreign Trade act**

Since concerned goods might be fallen under listed items of export control prescribed by Foreign exchange and Foreign trade act, please consult with ROHM in case of export.

**Precaution Regarding Intellectual Property Rights**

1. All information and data including but not limited to application example contained in this document is for reference only. ROHM does not warrant that foregoing information or data will not infringe any intellectual property rights or any other rights of any third party regarding such information or data.
2. ROHM shall not have any obligations where the claims, actions or demands arising from the combination of the Products with other articles such as components, circuits, systems or external equipment (including software).
3. No license, expressly or implied, is granted hereby under any intellectual property rights or other rights of ROHM or any third parties with respect to the Products or the information contained in this document. Provided, however, that ROHM will not assert its intellectual property rights or other rights against you or your customers to the extent necessary to manufacture or sell products containing the Products, subject to the terms and conditions herein.

**Other Precaution**

1. This document may not be reprinted or reproduced, in whole or in part, without prior written consent of ROHM.
2. The Products may not be disassembled, converted, modified, reproduced or otherwise changed without prior written consent of ROHM.
3. In no event shall you use in any way whatsoever the Products and the related technical information contained in the Products or this document for any military purposes, including but not limited to, the development of mass-destruction weapons.
4. The proper names of companies or products described in this document are trademarks or registered trademarks of ROHM, its affiliated companies or third parties.

**General Precaution**

1. Before you use our Products, you are requested to carefully read this document and fully understand its contents. ROHM shall not be in any way responsible or liable for failure, malfunction or accident arising from the use of any ROHM's Products against warning, caution or note contained in this document.
2. All information contained in this document is current as of the issuing date and subject to change without any prior notice. Before purchasing or using ROHM's Products, please confirm the latest information with a ROHM sales representative.
3. The information contained in this document is provided on an "as is" basis and ROHM does not warrant that all information contained in this document is accurate and/or error-free. ROHM shall not be in any way responsible or liable for any damages, expenses or losses incurred by you or third parties resulting from inaccuracy or errors of or concerning such information.

## Looking for pricing, stock, or lifecycle information?

Click below to explore more details on WIN SOURCE:

- ⊖ [View BUS1DJC3GWZ-E2 on WIN SOURCE](#)
- ⊖ [Rohm Semiconductor](#) Information

## Optimize Your Supply Chain with WIN SOURCE Solutions

- ✓ Global Sourcing Solution
- ✓ Obsolete Management
- ✓ Cost Control Management
- ✓ Shortage Management
- ✓ Alternative Solution
- ✓ Excess Inventory Management