

FEATURES

- AEC-Q100 Qualified for Automotive Applications
- Sample Rate: 200ksps
- 16-Bit No Missing Codes and ± 2 LSB Max INL
- 8-Channel Multiplexer with:
 - Single-Ended or Differential Inputs and
 - Unipolar or Bipolar Conversion Modes
- SPI/MICROWIRE Serial I/O
- Signal-to-Noise Ratio: 89dB
- Single 5V Operation
- On-Chip or External Reference
- Low Power: 1.3mA at 200ksps, 0.76mA at 100ksps
- Sleep Mode
- Automatic Nap Mode Between Conversions
- 16-Pin Narrow SSOP Package

APPLICATIONS

- Industrial Process Control
- High Speed Data Acquisition
- Battery Operated Systems
- Multiplexed Data Acquisition Systems
- Imaging Systems

DESCRIPTION

The **LTC[®]1863/LTC1867** are pin-compatible, 8-channel 12-/16-bit A/D converters with serial I/O, and an internal reference. The ADCs typically draw only 1.3mA from a single 5V supply.

The 8-channel input multiplexer can be configured for either single-ended or differential inputs and unipolar or bipolar conversions (or combinations thereof). The automatic nap and sleep modes benefit power sensitive applications.

The LTC1867's DC performance is outstanding with a ± 2 LSB INL specification and no missing codes over temperature. The signal-to-noise ratio (SNR) for the LTC1867 is typically 89dB, with the internal reference.

Housed in a compact, narrow 16-pin SSOP package, the LTC1863/LTC1867 can be used in space-sensitive as well as low-power applications.

All registered trademarks and trademarks are the property of their respective owners.

BLOCK DIAGRAM

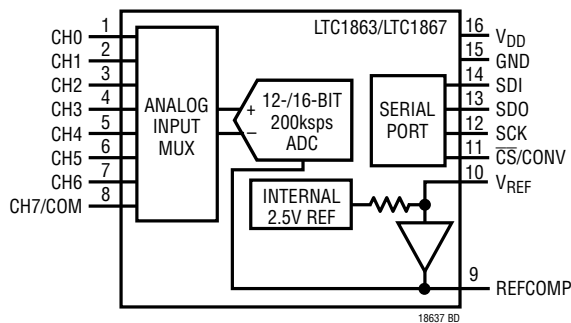

**Integral Nonlinearity vs Output Code
(LTC1867)**

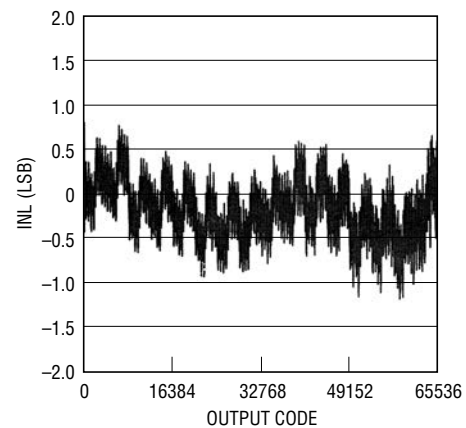

18637 G01

LTC1863/LTC1867

ABSOLUTE MAXIMUM RATINGS

(Note 1, 2)

Supply Voltage (V_{DD})	-0.3V to 6V
Analog Input Voltage	
CH0-CH7/COM (Note 3)	-0.3V to ($V_{DD} + 0.3V$)
V_{REF} , REFCOMP (Note 4)	-0.3V to ($V_{DD} + 0.3V$)
Digital Input Voltage (SDI, SCK, \overline{CS} /CONV)	
(Note 4)	-0.3V to 10V
Digital Output Voltage (SDO)	-0.3V to ($V_{DD} + 0.3V$)
Power Dissipation	500mW
Operating Temperature Range	
LTC1863C/LTC1867C/LTC1867AC	0°C to 70°C
LTC1863I/LTC1867I/LTC1867AI	-40°C to 85°C
Storage Temperature Range	-65°C to 150°C
Lead Temperature (Soldering, 10 sec).....	300°C

PIN CONFIGURATION

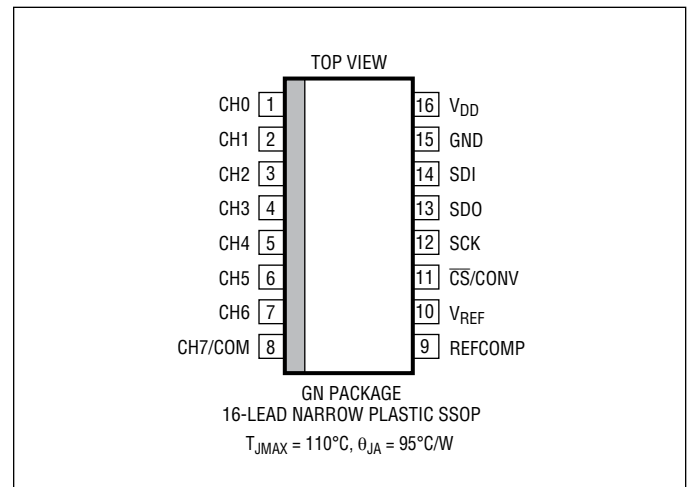

ORDER INFORMATION

LEAD FREE FINISH	TAPE AND REEL	PART MARKING*	PACKAGE DESCRIPTION	TEMPERATURE RANGE
LTC1863CGN#PBF	LTC1863CGN#TRPBF	1863	16-Lead Narrow Plastic SSOP	0°C to 70°C
LTC1863IGN#PBF	LTC1863IGN#TRPBF	1863	16-Lead Narrow Plastic SSOP	-40°C to 85°C
LTC1867CGN#PBF	LTC1867CGN#TRPBF	1867	16-Lead Narrow Plastic SSOP	0°C to 70°C
LTC1867IGN#PBF	LTC1867IGN#TRPBF	1867	16-Lead Narrow Plastic SSOP	-40°C to 85°C
LTC1867ACGN#PBF	LTC1867ACGN#TRPBF	1867	16-Lead Narrow Plastic SSOP	0°C to 70°C
LTC1867AIGN#PBF	LTC1867AIGN#TRPBF	1867	16-Lead Narrow Plastic SSOP	-40°C to 85°C

AUTOMOTIVE PRODUCTS**

LTC1863IGN#WPBF	LTC1863IGN#WTRPBF	1863	16-Lead Narrow Plastic SSOP	-40°C to 85°C
LTC1867IGN#WPBF	LTC1867IGN#WTRPBF	1867	16-Lead Narrow Plastic SSOP	-40°C to 85°C
LTC1867AIGN#WPBF	LTC1867AIGN#WTRPBF	1867	16-Lead Narrow Plastic SSOP	-40°C to 85°C

Contact the factory for parts specified with wider operating temperature ranges. *The temperature grade is identified by a label on the shipping container.

Tape and reel specifications. Some packages are available in 500 unit reels through designated sales channels with #TRMPBF suffix.

**Versions of this part are available with controlled manufacturing to support the quality and reliability requirements of automotive applications. These models are designated with a #W suffix. Only the automotive grade products shown are available for use in automotive applications. Contact your local Analog Devices account representative for specific product ordering information and to obtain the specific Automotive Reliability reports for these models.

CONVERTER CHARACTERISTICS

The ● denotes the specifications which apply over the full operating temperature range, otherwise specifications are at $T_A = 25^\circ\text{C}$. With external reference (Notes 5, 6)

PARAMETER	CONDITIONS		LTC1863			LTC1867			LTC1867A			UNITS
			MIN	TYP	MAX	MIN	TYP	MAX	MIN	TYP	MAX	
Resolution		●	12			16			16			Bits
No Missing Codes		●	12			15			16			Bits
Integral Linearity Error	Unipolar (Note 7)	●			±1			±4			±2	LSB
	Bipolar	●			±1			±4			±2.5	LSB
Differential Linearity Error		●			±1	-2		3	-1		1.75	LSB
Transition Noise				0.1			0.74			0.74		LSB _{RMS}
Offset Error	Unipolar (Note 8)	●			±3			±32			±32	LSB
	Bipolar	●			±4			±64			±64	LSB
Offset Error Match	Unipolar				±1			±2			±2	LSB
	Bipolar				±1			±2			±2	LSB

CONVERTER CHARACTERISTICS

The ● denotes the specifications which apply over the full operating temperature range, otherwise specifications are at $T_A = 25^\circ\text{C}$. With external reference (Notes 5, 6)

PARAMETER	CONDITIONS		LTC1863			LTC1867			LTC1867A			UNITS
			MIN	TYP	MAX	MIN	TYP	MAX	MIN	TYP	MAX	
Offset Error Drift				±0.5			±0.5			±0.5		ppm/°C
Gain Error	Unipolar				±6			±96			±64	LSB
	Bipolar				±6			±96			±64	LSB
Gain Error Match					±1			±4			±2	LSB
Gain Error Tempco	Internal Reference			±15			±15			±15		ppm/°C
	External Reference			±2.7			±2.7			±2.7		ppm/°C
Power Supply Sensitivity	$V_{DD} = 4.75\text{V} - 5.25\text{V}$			±1			±5			±5		LSB

DYNAMIC ACCURACY (Note 5)

SYMBOL	PARAMETER	CONDITIONS	LTC1863			LTC1867/LTC1867A			UNITS
			MIN	TYP	MAX	MIN	TYP	MAX	
SNR	Signal-to-Noise Ratio	1kHz Input Signal		73.6			89		dB
S/(N+D)	Signal-to-(Noise + Distortion) Ratio	1kHz Input Signal		73.5			88		dB
THD	Total Harmonic Distortion	1kHz Input Signal, Up to 5th Harmonic		-94.5			-95		dB
	Peak Harmonic or Spurious Noise	1kHz Input Signal		-94.5			-95		dB
	Channel-to-Channel Isolation	100kHz Input Signal		-100			-117		dB
	Full Power Bandwidth	-3dB Point		1.25			1.25		MHz

LTC1863/LTC1867

ANALOG INPUT

The ● denotes the specifications which apply over the full operating temperature range, otherwise specifications are at $T_A = 25^\circ\text{C}$. (Note 5)

SYMBOL	PARAMETER	CONDITIONS	LTC1863/LTC1867/LTC1867A			UNITS
			MIN	TYP	MAX	
	Analog Input Range	Unipolar Mode (Note 9) Bipolar Mode	● ●	0-4.096 ± 2.048		V V
C_{IN}	Analog Input Capacitance for CH0 to CH7/COM	Between Conversions (Sample Mode) During Conversions (Hold Mode)		32 4		pF pF
t_{ACQ}	Sample-and-Hold Acquisition Time		●	1.5 1.1		μs
	Input Leakage Current	On Channels, $CHX = 0V$ or V_{DD}	●		± 1	μA

INTERNAL REFERENCE CHARACTERISTICS (Note 5)

PARAMETER	CONDITIONS	LTC1863/LTC1867/LTC1867A			UNITS
		MIN	TYP	MAX	
V_{REF} Output Voltage	$I_{OUT} = 0$	2.48	2.5	2.52	V
V_{REF} Output Tempco	$I_{OUT} = 0$		± 15		ppm/ $^\circ\text{C}$
V_{REF} Line Regulation	$4.75V \leq V_{DD} \leq 5.25V$		0.43		mV/V
V_{REF} Output Resistance	$ I_{OUT} \leq 0.1\text{mA}$		6		k Ω
REFCOMP Output Voltage	$I_{OUT} = 0$		4.096		V

DIGITAL INPUTS AND DIGITAL OUTPUTS

The ● denotes the specifications which apply over the full operating temperature range, otherwise specifications are at $T_A = 25^\circ\text{C}$. (Note 5)

SYMBOL	PARAMETER	CONDITIONS	LTC1863/LTC1867/LTC1867A			UNITS
			MIN	TYP	MAX	
V_{IH}	High Level Input Voltage	$V_{DD} = 5.25V$	●	2.4		V
V_{IL}	Low Level Input Voltage	$V_{DD} = 4.75V$	●		0.8	V
I_{IN}	Digital Input Current	$V_{IN} = 0V$ to V_{DD}	●		± 10	μA
C_{IN}	Digital Input Capacitance			2		pF
V_{OH}	High Level Output Voltage (SDO)	$V_{DD} = 4.75V, I_O = -10\mu\text{A}$ $V_{DD} = 4.75V, I_O = -200\mu\text{A}$	●	4 4.75 4.74		V V
V_{OL}	Low Level Output Voltage (SDO)	$V_{DD} = 4.75V, I_O = 160\mu\text{A}$ $V_{DD} = 4.75V, I_O = 1.6\text{mA}$	●	0.05 0.1	0.4	V V
I_{SOURCE}	Output Source Current	SDO = 0V		-32		mA
I_{SINK}	Output Sink Current	SDO = V_{DD}		19		mA
	Hi-Z Output Leakage Hi-Z Output Capacitance	$\overline{CS}/CONV = \text{High}, \text{SDO} = 0V$ or V_{DD} $\overline{CS}/CONV = \text{High}$ (Note 10)	● ●		± 10 15	μA pF
	Data Format	Unipolar Bipolar		Straight Binary Two's Complement		

POWER REQUIREMENTS

The ● denotes the specifications which apply over the full operating temperature range, otherwise specifications are at $T_A = 25^\circ\text{C}$. (Note 5)

SYMBOL	PARAMETER	CONDITIONS	LTC1863/LTC1867/LTC1867A			UNITS
			MIN	TYP	MAX	
V_{DD}	Supply Voltage	(Note 9)	4.75		5.25	V
I_{DD}	Supply Current	$f_{\text{SAMPLE}} = 200\text{ksps}$ NAP Mode SLEEP Mode	●	1.3 150	1.8	mA μA μA
P_{DISS}	Power Dissipation	●		6.5	9	mW

TIMING CHARACTERISTICS

The ● denotes the specifications which apply over the full operating temperature range, otherwise specifications are at $T_A = 25^\circ\text{C}$. (Note 5)

SYMBOL	PARAMETER	CONDITIONS	LTC1863/LTC1867/LTC1867A			UNITS
			MIN	TYP	MAX	
f_{SAMPLE}	Maximum Sampling Frequency	●	200			kHz
t_{CONV}	Conversion Time	●		3	3.5	μs
t_{ACQ}	Acquisition Time	●	1.5	1.1		μs
f_{SCK}	SCK Frequency				40	MHz
t_1	$\overline{\text{CS}}/\text{CONV}$ High Time	Short $\overline{\text{CS}}/\text{CONV}$ Pulse Mode ●	40	100		ns
t_2	SDO Valid After SCK↓	$C_L = 25\text{pF}$ (Note 11) ●		13	22	ns
t_3	SDO Valid Hold Time After SCK↓	$C_L = 25\text{pF}$ ●	5	11		ns
t_4	SDO Valid After $\overline{\text{CS}}/\text{CONV}$ ↓	$C_L = 25\text{pF}$ ●		10	30	ns
t_5	SDI Setup Time Before SCK↑	●	15	-6		ns
t_6	SDI Hold Time After SCK↑	●	10	4		ns
t_7	SLEEP Mode Wake-Up Time	$C_{\text{REFCOMP}} = 10\mu\text{F}$, $C_{\text{VREF}} = 2.2\mu\text{F}$		60		ms
t_8	Bus Relinquish Time After $\overline{\text{CS}}/\text{CONV}$ ↑	$C_L = 25\text{pF}$ ●		20	40	ns

Note 1: Stresses beyond those listed under Absolute Maximum Ratings may cause permanent damage to the device. Exposure to any Absolute Maximum Rating condition for extended periods may affect device reliability and lifetime.

Note 2: All voltage values are with respect to GND (unless otherwise noted).

Note 3: When these pin voltages are taken below GND or above V_{DD} , they will be clamped by internal diodes. This product can handle input currents up to 100mA without latchup.

Note 4: When these pin voltages are taken below GND, they will be clamped by internal diodes. This product can handle input currents up to 100mA below GND without latchup. These pins are not clamped to V_{DD} .

Note 5: $V_{DD} = 5\text{V}$, $f_{\text{SAMPLE}} = 200\text{ksps}$ at 25°C , $t_r = t_f = 5\text{ns}$ and $V_{\text{IN}^-} = 2.5\text{V}$ for bipolar mode unless otherwise specified.

Note 6: Linearity, offset and gain error specifications apply for both unipolar and bipolar modes. The INL and DNL are tested in bipolar mode.

Note 7: Integral nonlinearity is defined as the deviation of a code from a straight line passing through the actual endpoints of the transfer curve. The deviation is measured from the center of the quantization band.

Note 8: Unipolar offset is the offset voltage measured from $+1/2\text{LSB}$ when the output code flickers between 0000 0000 0000 0000 and 0000 0000 0000 0001 for LTC1867 and between 0000 0000 0000 and 0000 0000 0001 for LTC1863. Bipolar offset is the offset voltage measured from $-1/2\text{LSB}$ when output code flickers between 0000 0000 0000 0000 and 1111 1111 1111 1111 for LTC1867, and between 0000 0000 0000 and 1111 1111 1111 for LTC1863.

Note 9: Recommended operating conditions. The input range of $\pm 2.048\text{V}$ for bipolar mode is measured with respect to $V_{\text{IN}^-} = 2.5\text{V}$.

Note 10: Guaranteed by design, not subject to test.

Note 11: t_2 of 25ns maximum allows f_{SCK} up to 20MHz for rising capture with 50% duty cycle and f_{SCK} up to 40MHz for falling capture (with 3ns setup time for the receiving logic).

TYPICAL PERFORMANCE CHARACTERISTICS (LTC1867)

Integral Nonlinearity vs Output Code

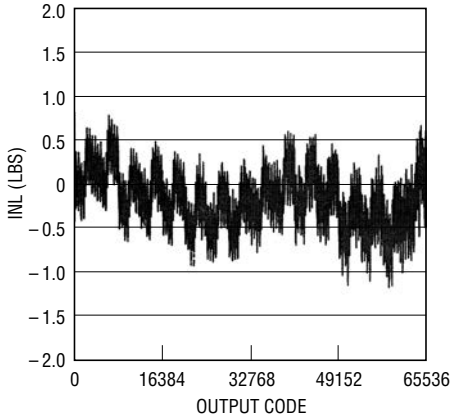

18637 G01

Differential Nonlinearity vs Output Code

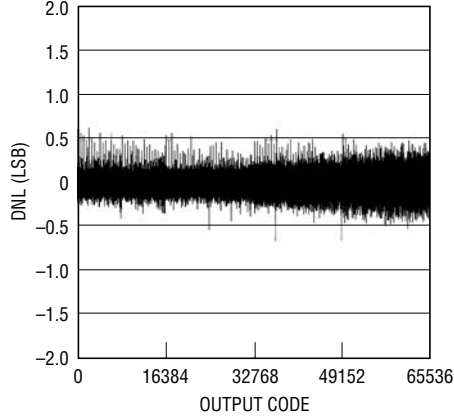

18637 G02

Histogram for 4096 Conversions

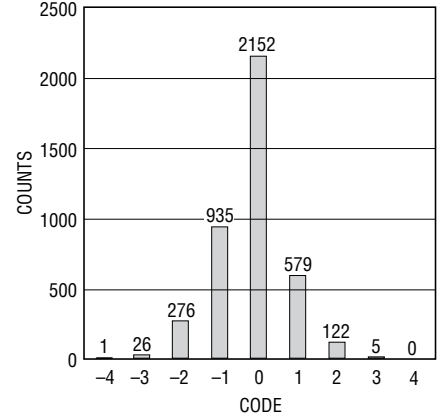

18637 G03

4096 Points FFT Plot ($f_{IN} = 1\text{kHz}$)

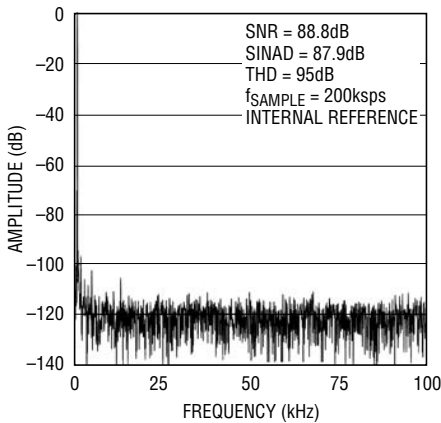

18637 G04

4096 Points FFT Plot ($f_{IN} = 1\text{kHz}$, REFCOMP = External 5V)

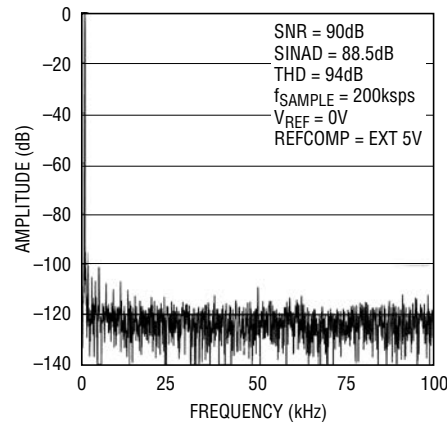

18637 G05

Crosstalk vs Input Frequency

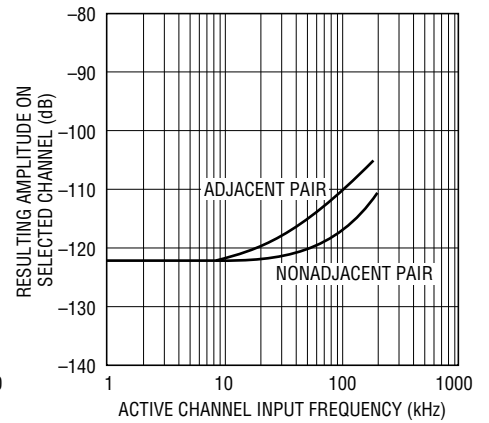

18637 G06

Signal-to-Noise Ratio vs Frequency

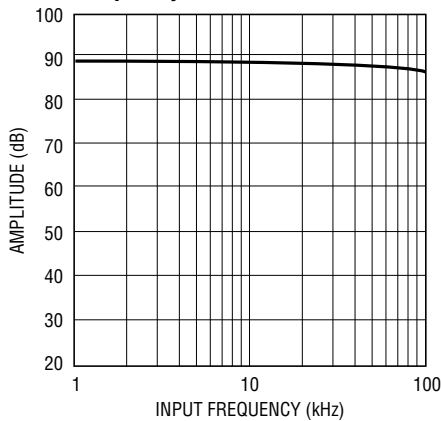

18637 G07

Signal-to-(Noise + Distortion) vs Input Frequency

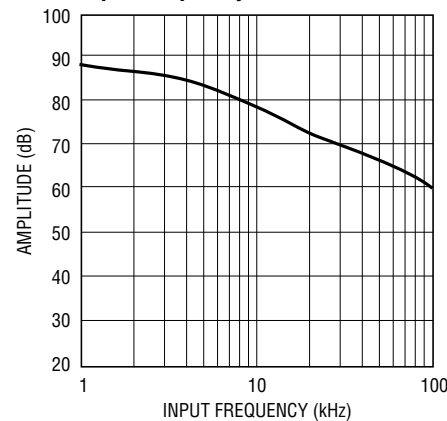

18637 G08

Total Harmonic Distortion vs Input Frequency

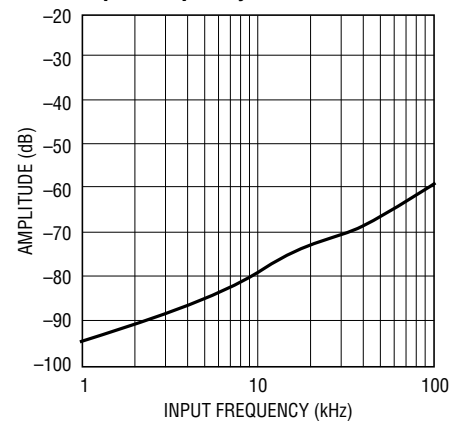

18637 G09

TYPICAL PERFORMANCE CHARACTERISTICS

(LTC1863/LTC1867)

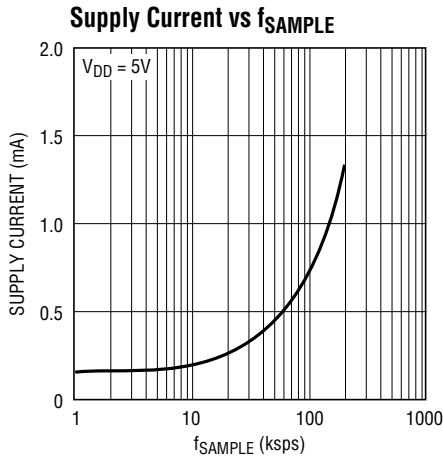

18637 G10

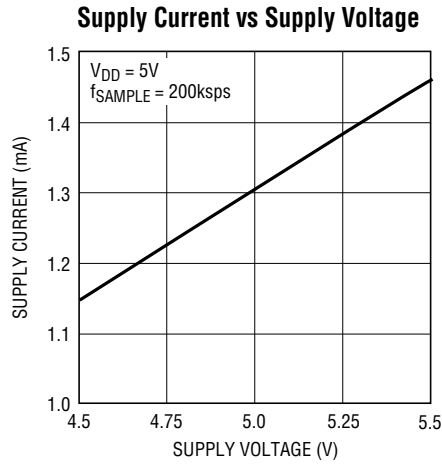

18637 G11

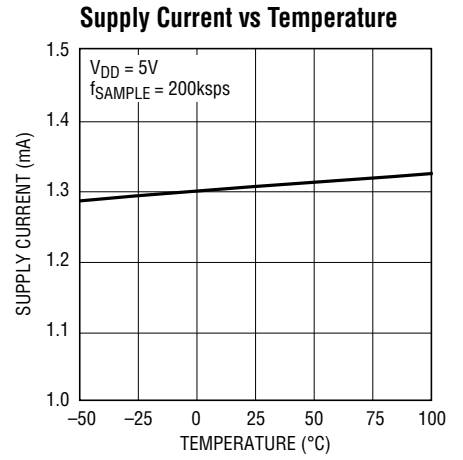

18637 G12

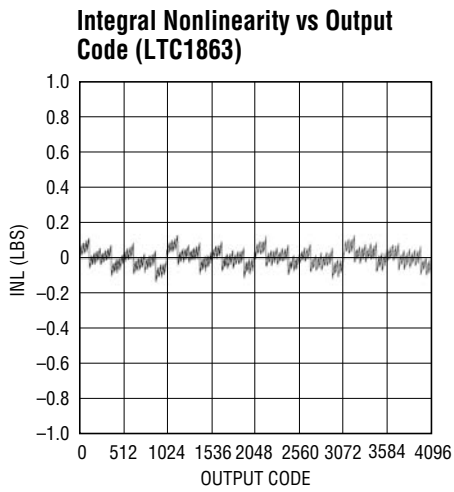

18637 G13

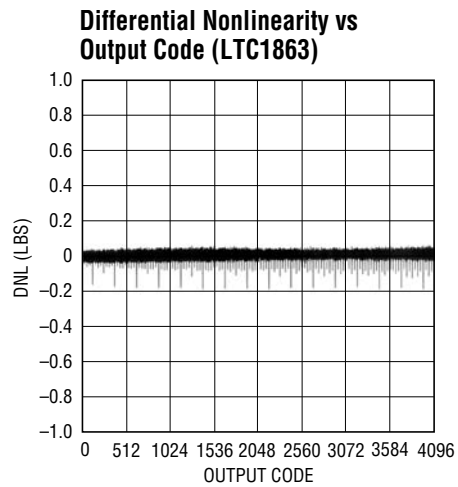

18637 G14

PIN FUNCTIONS

CH0-CH7/COM (Pins 1-8): Analog Input Pins. Analog inputs must be free of noise with respect to GND. CH7/COM can be either a separate channel or the common minus input for the other channels.

REFCOMP (Pin 9): Reference Buffer Output Pin. Bypass to GND with a 10 μ F tantalum capacitor in parallel with a 0.1 μ F ceramic capacitor (4.096V Nominal). To overdrive REFCOMP, tie V_{REF} to GND.

V_{REF} (Pin 10): 2.5V Reference Output. This pin can also be used as an external reference buffer input for improved accuracy and drift. Bypass to GND with a 2.2 μ F tantalum capacitor in parallel with a 0.1 μ F ceramic capacitor.

$\overline{CS}/CONV$ (Pin 11): This input provides the dual function of initiating conversions on the ADC and also frames the serial data transfer.

SCK (Pin 12): Shift Clock. This clock synchronizes the serial data transfer.

SDO (Pin 13): Digital Data Output. The A/D conversion result is shifted out of this output. Straight binary format for unipolar mode and two's complement format for bipolar mode.

SDI (Pin 14): Digital Data Input Pin. The A/D configuration word is shifted into this input.

GND (Pin 15): Analog and Digital GND.

V_{DD} (Pin 16): Analog and Digital Power Supply. Bypass to GND with a 10 μ F tantalum capacitor in parallel with a 0.1 μ F ceramic capacitor. When powering up the LTC1863/LTC1867, or any time V_{DD} falls below the minimum specified operating voltage, one dummy conversion must be initiated by providing a rising edge on the $\overline{CS}/CONV$ pin. The first conversion result may be invalid and should be ignored. Once the $\overline{CS}/CONV$ pin is returned low, a DIN word can be shifted into SDI to program the configuration for the next conversion. Wait at least t_7 , the SLEEP mode wake-up time of 80ms, before initiating the second conversion to obtain a valid conversion result.

TYPICAL CONNECTION DIAGRAM

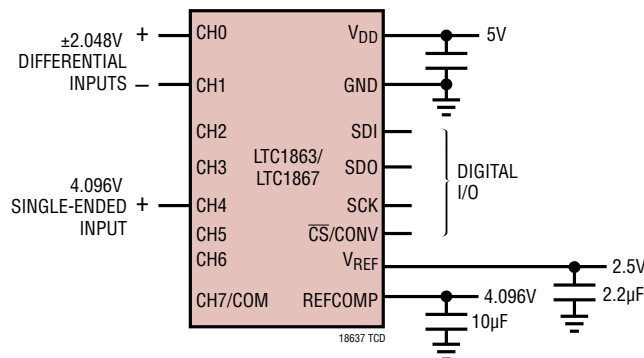

TEST CIRCUITS

Load Circuits for Access Timing

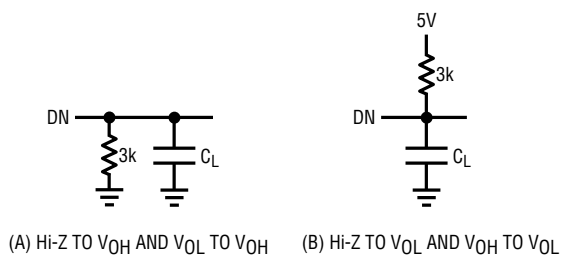

Load Circuits for Output Float Delay

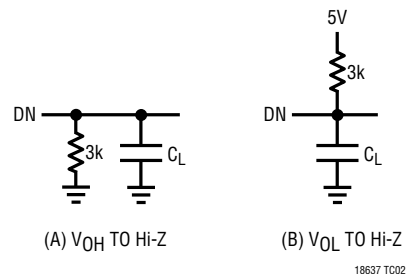

TIMING DIAGRAMS

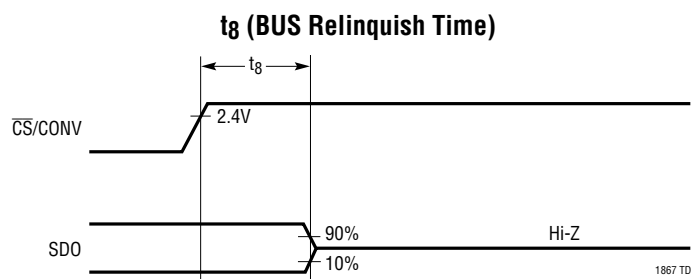
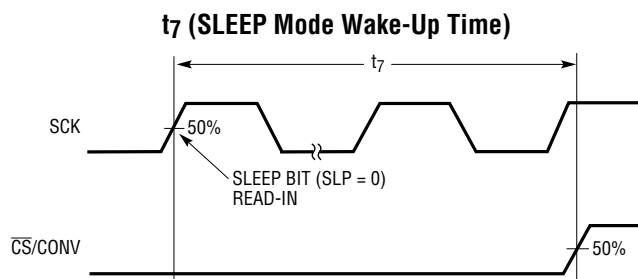
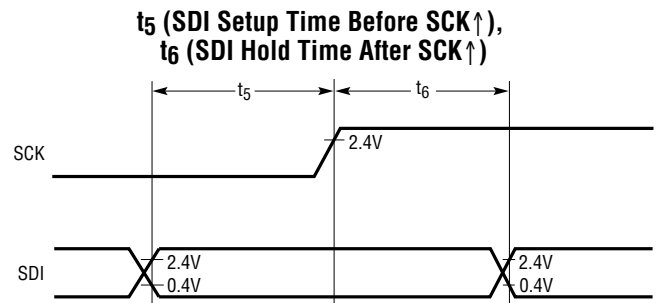
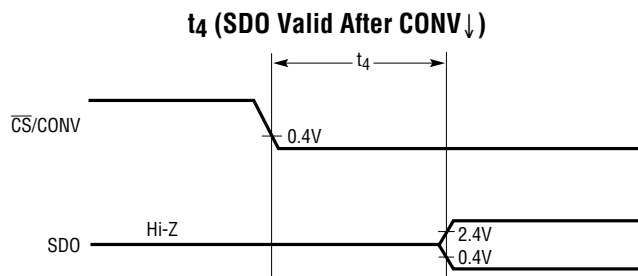
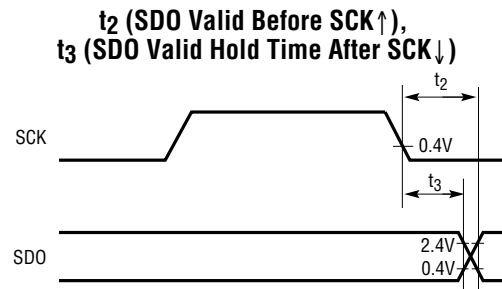
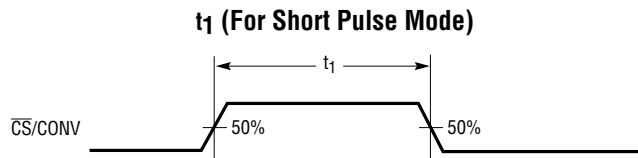

APPLICATIONS INFORMATION

Overview

The LTC1863/LTC1867 are complete, low power multiplexed ADCs. They consist of a 12-/16-bit, 200ksps capacitive successive approximation A/D converter, a precision internal reference, a configurable 8-channel analog input multiplexer (MUX) and a serial port for data transfer.

Conversions are started by a rising edge on the $\overline{\text{CS}}/\text{CONV}$ input. Once a conversion cycle has begun, it cannot be restarted. Between conversions, the ADCs receive an input word for channel selection and output the conversion result, and the analog input is acquired in preparation for the next conversion. In the acquire phase, a minimum time of 1.5 μs will provide enough time for the sample-and-hold capacitors to acquire the analog signal.

During the conversion, the internal differential 16-bit capacitive DAC output is sequenced by the SAR from the most significant bit (MSB) to the least significant bit (LSB). The input is successively compared with the binary weighted charges supplied by the differential capacitive DAC. Bit decisions are made by a low-power, differential comparator. At the end of a conversion, the DAC output balances the analog input. The SAR contents (a 12-/16-bit data word) that represent the analog input are loaded into the 12-/16-bit output latches.

APPLICATIONS INFORMATION

Analog Input Multiplexer

The analog input multiplexer is controlled by a 7-bit input data word. The input data word is defined as follows:

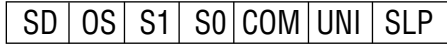

SD = SINGLE/DIFFERENTIAL BIT

OS = ODD/SIGN BIT

S1 = ADDRESS SELECT BIT 1

S0 = ADDRESS SELECT BIT 0

COM = CH7/COM CONFIGURATION BIT

UNI = UNIPOLAR/BIPOLAR BIT

SLP = SLEEP MODE BIT

Examples of Multiplexer Options

4 Differential

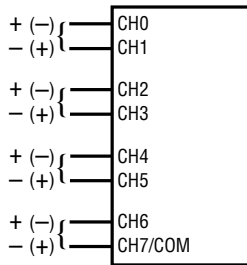

8 Single-Ended

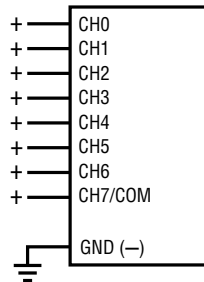

7 Single-Ended to CH7/COM

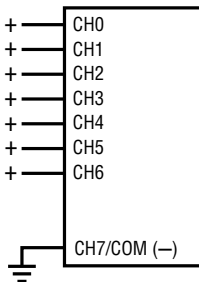

Combinations of Differential and Single-Ended

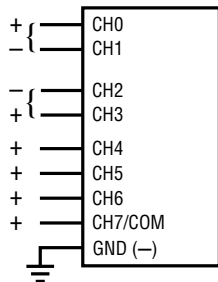

18637 AI01

Changing the MUX Assignment "On the Fly"

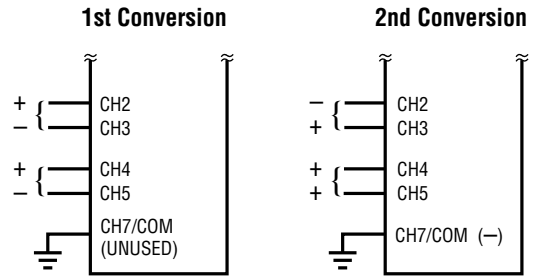

18637 AI02

Tables 1 and 2 show the configurations when COM = 0, and COM = 1.

Table 1. Channel Configuration (When COM = 0, CH7/COM Pin Is Used as CH7)

SD	OS	S1	S0	COM	Channel Configuration	
					"+"	"-"
0	0	0	0	0	CH0	CH1
0	0	0	1	0	CH2	CH3
0	0	1	0	0	CH4	CH5
0	0	1	1	0	CH6	CH7
0	1	0	0	0	CH1	CH0
0	1	0	1	0	CH3	CH2
0	1	1	0	0	CH5	CH4
0	1	1	1	0	CH7	CH6
1	0	0	0	0	CH0	GND
1	0	0	1	0	CH2	GND
1	0	1	0	0	CH4	GND
1	0	1	1	0	CH6	GND
1	1	0	0	0	CH1	GND
1	1	0	1	0	CH3	GND
1	1	1	0	0	CH5	GND
1	1	1	1	0	CH7	GND

Table 2. Channel Configuration (When COM = 1, CH7/COM Pin Is Used as COMMON)

SD	OS	S1	S0	COM	Channel Configuration	
					"+"	"-"
1	0	0	0	1	CH0	CH7/COM
1	0	0	1	1	CH2	CH7/COM
1	0	1	0	1	CH4	CH7/COM
1	0	1	1	1	CH6	CH7/COM
1	1	0	0	1	CH1	CH7/COM
1	1	0	1	1	CH3	CH7/COM
1	1	1	0	1	CH5	CH7/COM

Rev. E

APPLICATIONS INFORMATION

Driving the Analog Inputs

The analog inputs of the LTC1863/LTC1867 are easy to drive. Each of the analog inputs can be used as a single-ended input relative to the GND pin (CH0-GND, CH1-GND, etc) or in pairs (CH0 and CH1, CH2 and CH3, CH4 and CH5, CH6 and CH7) for differential inputs. In addition, CH7 can act as a COM pin for both single-ended and differential modes if the COM bit in the input word is high. Regardless of the MUX configuration, the “+” and “-” inputs are sampled at the same instant. Any unwanted signal that is common mode to both inputs will be reduced by the common mode rejection of the sample-and-hold circuit. The inputs draw only one small current spike while charging the sample-and-hold capacitors during the acquire mode. In conversion mode, the analog inputs draw only a small leakage current. If the source impedance of the driving circuit is low then the LTC1863/LTC1867 inputs can be driven directly. More acquisition time should be allowed for a higher impedance source.

The following list is a summary of the op amps that are suitable for driving the LTC1863/LTC1867.

LT1007 - Low noise precision amplifier. 2.7mA supply current $\pm 5V$ to $\pm 15V$ supplies. Gain bandwidth product 8MHz. DC applications.

LT1097 - Low cost, low power precision amplifier. 300 μA supply current. $\pm 5V$ to $\pm 15V$ supplies. Gain bandwidth product 0.7MHz. DC applications.

LT1227 - 140MHz video current feedback amplifier. 10mA supply current. $\pm 5V$ to $\pm 15V$ supplies. Low noise and low distortion.

LT1360 - 37MHz voltage feedback amplifier. 3.8mA supply current. $\pm 5V$ to $\pm 15V$ supplies. Good AC/DC specs.

LT1363 - 50MHz voltage feedback amplifier. 6.3mA supply current. Good AC/DC specs.

LT1364/LT1365 - Dual and quad 50MHz voltage feedback amplifiers. 6.3mA supply current per amplifier. Good AC/DC specs.

LT1468 - 90MHz, 22V/ μs 16-bit accurate amplifier

LT1469 - Dual LT1468

Input Filtering

The noise and the distortion of the input amplifier and other circuitry must be considered since they will add to the LTC1863/LTC1867 noise and distortion. Noisy input circuitry should be filtered prior to the analog inputs to minimize noise. A simple 1-pole RC filter is sufficient for many applications. For instance, Figure 1 shows a 50 Ω source resistor and a 2000pF capacitor to ground on the input will limit the input bandwidth to 1.6MHz. The source impedance has to be kept low to avoid gain error and degradation in the AC performance. The capacitor also acts as a charge reservoir for the input sample-and-hold and isolates the ADC input from sampling glitch sensitive circuitry. High quality capacitors and resistors should be used since these components can add distortion. NPO and silver mica type dielectric capacitors have excellent linearity. Carbon surface mount resistors can also generate distortion from self heating and from damage that may occur during soldering. Metal film surface mount resistors are much less susceptible to both problems.

APPLICATIONS INFORMATION

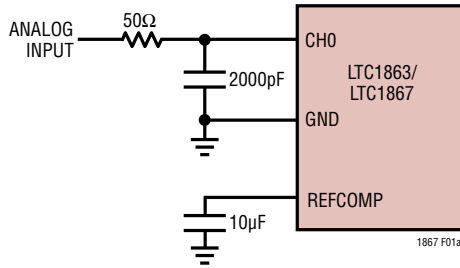

Figure 1a. Optional RC Input Filtering for Single-Ended Input

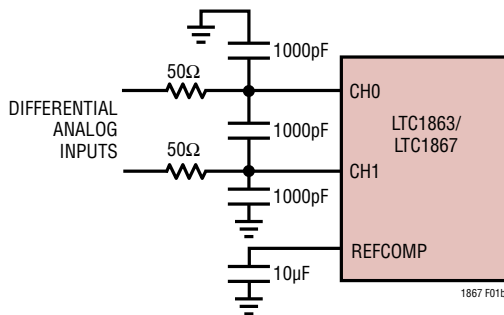

Figure 1b. Optional RC Input Filtering for Differential Inputs

DC Performance

One way of measuring the transition noise associated with a high resolution ADC is to use a technique where a DC signal is applied to the input of the ADC and the resulting output codes are collected over a large number of conversions. For example, in Figure 2 the distribution of output codes is shown for a DC input that had been digitized 4096 times. The distribution is Gaussian and the RMS code transition noise is about 0.74LSB.

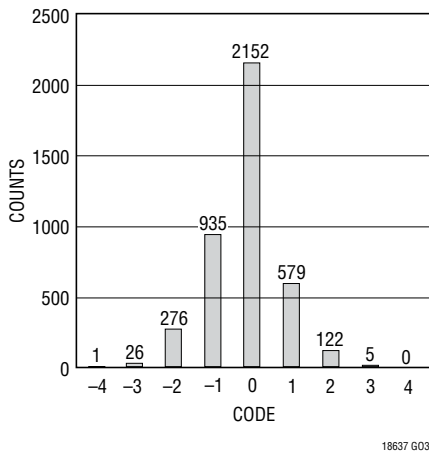

Figure 2. LTC1867 Histogram for 4096 Conversions

Dynamic Performance

FFT (Fast Fourier Transform) test techniques are used to test the ADC's frequency response, distortion and noise at the rated throughput. By applying a low distortion sine wave and analyzing the digital output using an FFT algorithm, the ADC's spectral content can be examined for frequencies outside the fundamental.

Signal-to-Noise Ratio

The Signal-to-Noise and Distortion Ratio (SINAD) is the ratio between the RMS amplitude of the fundamental input frequency to the RMS amplitude of all other frequency components at the A/D output. The output is band limited to frequencies from above DC and below half the sampling frequency. Figure 3 shows a typical SINAD of 87.9dB with a 200kHz sampling rate and a 1kHz input. When an external 5V is applied to REFCOMP (tie V_{REF} to GND), a signal-to-noise ratio of 90dB can be achieved.

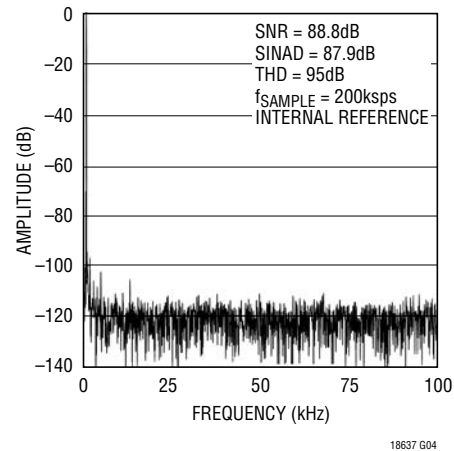

Figure 3. LTC1867 Nonaveraged 4096 Point FFT Plot

Total Harmonic Distortion

Total Harmonic Distortion (THD) is the ratio of the RMS sum of all harmonics of the input signal to the fundamental itself. The out-of-band harmonics alias into the frequency band between DC and half the sampling frequency. THD is expressed as:

$$THD = 20 \log \frac{\sqrt{V_2^2 + V_3^2 + V_4^2 \dots + V_N^2}}{V_1}$$

APPLICATIONS INFORMATION

where V_1 is the RMS amplitude of the fundamental frequency and V_2 through V_N are the amplitudes of the second through Nth harmonics.

Internal Reference

The LTC1863/LTC1867 has an on-chip, temperature compensated, curvature corrected, bandgap reference that is factory trimmed to 2.5V. It is internally connected to a reference amplifier and is available at V_{REF} (Pin 10). A 6k resistor is in series with the output so that it can be easily overdriven by an external reference if better drift and/or accuracy are required as shown in Figure 4. The reference amplifier gains the V_{REF} voltage by 1.638V/V to 4.096V at REFCOMP (Pin 9). This reference amplifier compensation pin, REFCOMP, must be bypassed with a 10 μ F ceramic or tantalum in parallel with a 0.1 μ F ceramic for best noise performance.

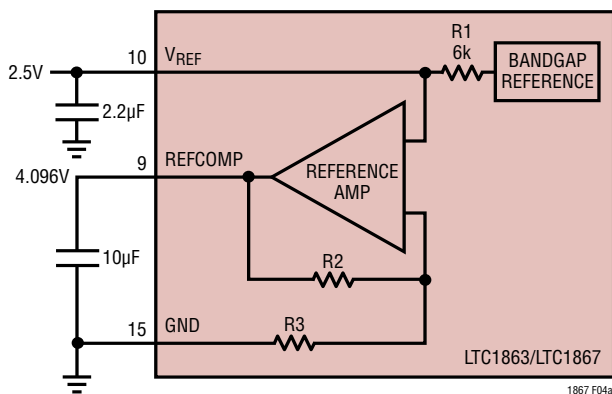

Figure 4a. LTC1867 Reference Circuit

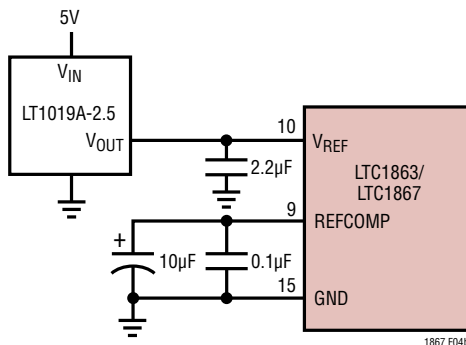

Figure 4b. Using the LT1019-2.5 as an External Reference

Digital Interface

The LTC1863/LTC1867 have a very simple digital interface that is enabled by the control input, $\overline{CS}/CONV$. A logic rising edge applied to the $\overline{CS}/CONV$ input will initiate a conversion. After the conversion, taking $\overline{CS}/CONV$ low will enable the serial port and the ADC will present digital data in two's complement format in bipolar mode or straight binary format in unipolar mode, through the SCK/SDO serial port.

Internal Clock

The internal clock is factory trimmed to achieve a typical conversion time of 3 μ s and a maximum conversion time, 3.5 μ s, over the full operating temperature range. The typical acquisition time is 1.1 μ s, and a throughput sampling rate of 200ksps is tested and guaranteed.

Automatic Nap Mode

The LTC1863/LTC1867 go into automatic nap mode when $\overline{CS}/CONV$ is held high after the conversion is complete (see Figure 6). With a typical operating current of 1.3mA and automatic 150 μ A nap mode between conversions, the power dissipation drops with reduced sample rate. The ADC only keeps the V_{REF} and REFCOMP voltages active when the part is in the automatic nap mode. The slower the sample rate allows the power dissipation to be lower (see Figure 5).

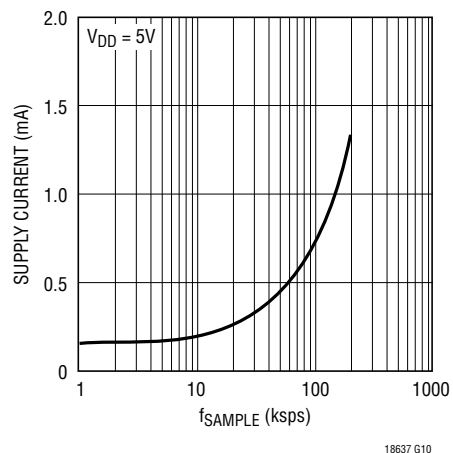

Figure 5. Supply Current vs f_{SAMPLE}

APPLICATIONS INFORMATION

If the $\overline{\text{CS/CONV}}$ returns low during a bit decision, it can create a small error. For best performance ensure that the $\overline{\text{CS/CONV}}$ returns low either within 100ns after the conversion starts (i.e. before the first bit decision) or after the conversion ends. If $\overline{\text{CS/CONV}}$ is low when the conversion ends, the MSB bit will appear on SDO at the end of the conversion and the ADC will remain powered up (see Figure 7).

Sleep Mode

If the $\text{SLP} = 1$ is selected in the input word, the ADC will enter SLEEP mode and draw only leakage current (provided that all the digital inputs stay at GND or V_{DD}). After release from the SLEEP mode, the ADC need 60ms to wake up (2.2 μF /10 μF bypass capacitors on V_{REF} /REFCOMP pins).

Board Layout and Bypassing

To obtain the best performance, a printed circuit board with a ground plane is required. Layout for the printed circuit board should ensure digital and analog signal lines are separated as much as possible. In particular, care should be taken not to run any digital signal alongside an analog signal.

All analog inputs should be screened by GND. V_{REF} , REFCOMP and V_{DD} should be bypassed to this ground plane as close to the pin as possible; the low impedance

of the common return for these bypass capacitors is essential to the low noise operation of the ADC. The width for these tracks should be as wide as possible.

Timing and Control

Conversion start is controlled by the $\overline{\text{CS/CONV}}$ digital input. The rising edge transition of the $\overline{\text{CS/CONV}}$ will start a conversion. Once initiated, it cannot be restarted until the conversion is complete. Figure 6 and Figure 7 show the timing diagrams for two types of $\overline{\text{CS/CONV}}$ pulses.

Example 1 (Figure 6) shows the LTC1863/LTC1867 operating in automatic nap mode with $\overline{\text{CS/CONV}}$ signal staying HIGH after the conversion. Automatic nap mode provides power reduction at reduced sample rate. The ADCs can also operate with the $\overline{\text{CS/CONV}}$ signal returning LOW before the conversion ends. In this mode (Example 2, Figure 7), the ADCs remain powered up.

For best performance, it is recommended to keep SCK, SDI, and SDO at a constant logic high or low during acquisition and conversion, even though these signals may be ignored by the serial interface (DON'T CARE). Communication with other devices on the bus should not coincide with the conversion period (t_{CONV}).

Figure 8 and Figure 9 are the transfer characteristics for the bipolar and unipolar mode.

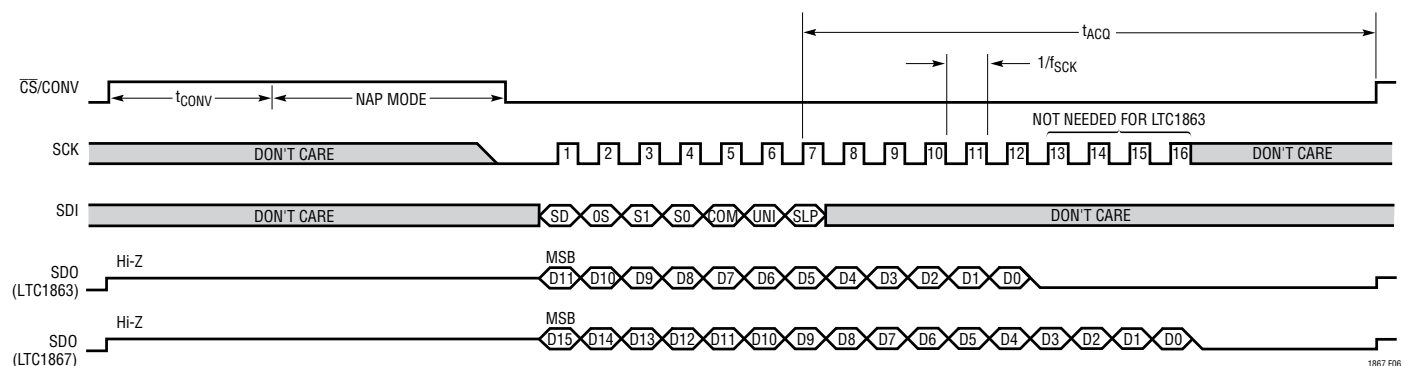

Figure 6. Example 1, $\overline{\text{CS/CONV}}$ Starts a Conversion and Remains HIGH Until Next Data Transfer. With $\overline{\text{CS/CONV}}$ Remaining HIGH After the Conversion, Automatic Nap Modes Provides Power Reduction at Reduced Sample Rate.

APPLICATIONS INFORMATION

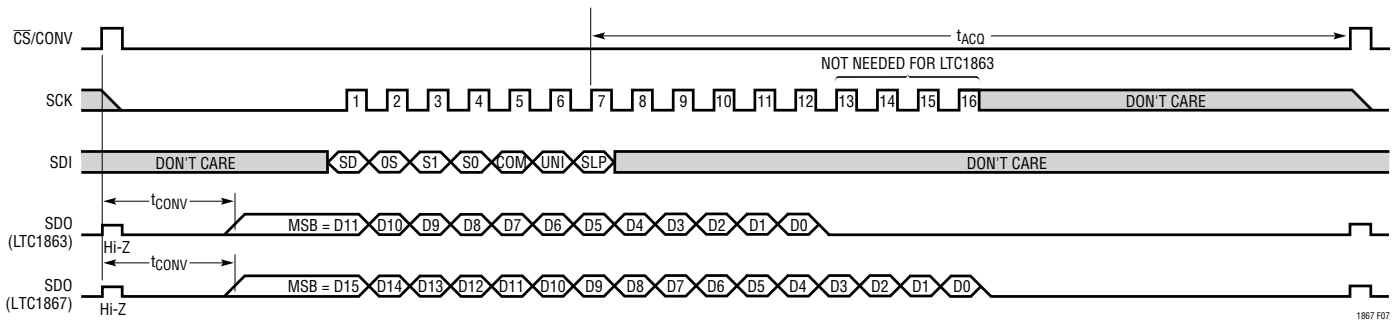

Figure 7. Example 2, $\overline{CS}/CONV$ Starts a Conversion With Short Active HIGH Pulse. With $\overline{CS}/CONV$ Returning LOW Before the Conversion, the ADC Remains Powered Up

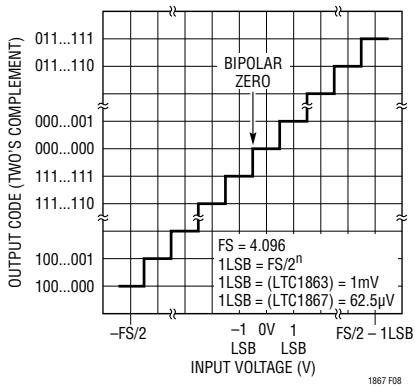

Figure 8. LTC1863/LTC1867 Bipolar Transfer Characteristics (Two's Complement)

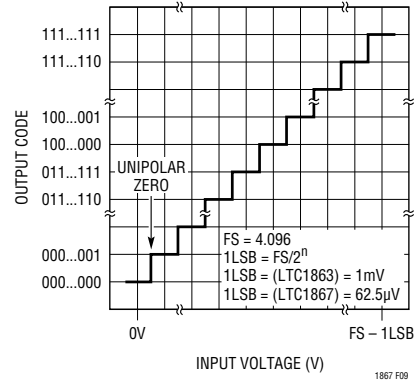
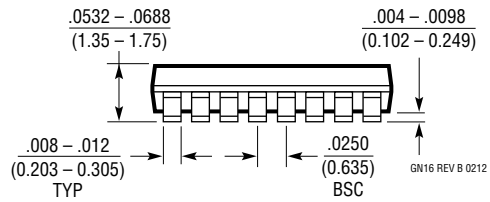
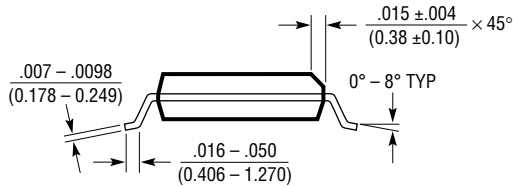
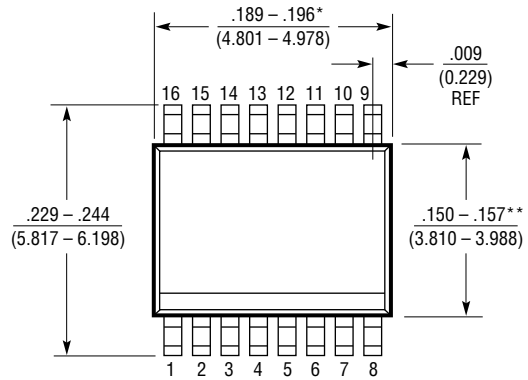
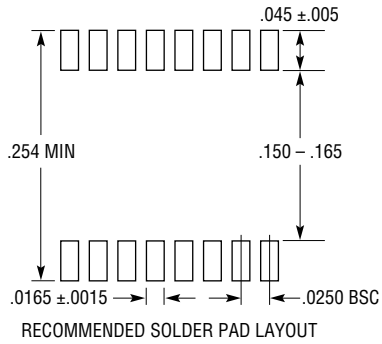

Figure 9. LTC1863/LTC1867 Unipolar Transfer Characteristics (Straight Binary)

PACKAGE DESCRIPTION

GN Package
16-Lead Plastic SSOP (Narrow .150 Inch)
 (Reference LTC DWG # 05-08-1641 Rev B)



NOTE:

1. CONTROLLING DIMENSION: INCHES
2. DIMENSIONS ARE IN $\frac{\text{INCHES}}{\text{MILLIMETERS}}$
3. DRAWING NOT TO SCALE
4. PIN 1 CAN BE BEVEL EDGE OR A DIMPLE

* DIMENSION DOES NOT INCLUDE MOLD FLASH. MOLD FLASH SHALL NOT EXCEED 0.006^* (0.152mm) PER SIDE

** DIMENSION DOES NOT INCLUDE INTERLEAD FLASH. INTERLEAD FLASH SHALL NOT EXCEED 0.010^* (0.254mm) PER SIDE

REVISION HISTORY

REV	DATE	DESCRIPTION	PAGE NUMBER
B	6/14	Fixed the Order Information.	2
C	5/15	Adjusted Notes 3 and 4 to specify input currents up to 100mA.	5
D	2/18	Added dummy conversion requirement on power up to V_{DD} pin description	8
E	4/19	Added Automotive AEC-Q100 qualified products	2

RELATED PARTS

PART NUMBER	DESCRIPTION	COMMENTS
LTC1417	14-Bit, 400ksps Serial ADC	20mW, Unipolar or Bipolar, Internal Reference, SSOP-16 Package
LT1460	Micropower Precision Series Reference	Bandgap, 130 μ A Supply Current, 10ppm/ $^{\circ}$ C, SOT-23 Package
LT1468/LT1469	Single/Dual 90MHz, 22V/ μ s, 16-Bit Accurate Op Amps	Low Input Offset: 75 μ V/125 μ V
LTC1609	16-Bit, 200ksps Serial ADC	65mW, Configurable Bipolar and Unipolar Input Ranges, 5V Supply
LT1790	Micropower Low Dropout Reference	60 μ A Supply Current, 10ppm/ $^{\circ}$ C, SOT-23 Package
LTC1850/LTC1851	10-Bit/12-Bit, 8-Channel, 1.25Msps ADC	Parallel Output, Programmable MUX and Sequencer, 5V Supply
LTC1852/LTC1853	10-Bit/12-Bit, 8-Channel, 400ksps ADC	Parallel Output, Programmable MUX and Sequencer, 3V or 5V Supply
LTC1860/LTC1861	12-Bit, 1-/2-Channel 250ksps ADC in MSOP	850 μ A at 250ksps, 2 μ A at 1ksps, SO-8 and MSOP Packages
LTC1860L/LTC1861L	3V, 12-Bit, 1-/2-Channel 150ksps ADC	450 μ A at 150ksps, 10 μ A at 1ksps, SO-8 and MSOP Packages
LTC1864/LTC1865	16-Bit, 1-/2-Channel 250ksps ADC in MSOP	850 μ A at 250ksps, 2 μ A at 1ksps, SO-8 and MSOP Packages
LTC1864L/LTC1865L	3V, 16-Bit, 1-/2-Channel 150ksps ADC in MSOP	450 μ A at 150ksps, 10 μ A at 1ksps, SO-8 and MSOP Packages

Looking for pricing, stock, or lifecycle information?

Click below to explore more details on WIN SOURCE:

 [View LTC1867CGN#PBF on WIN SOURCE](#)

 [Linear Technology](#) Information

Optimize Your Supply Chain with WIN SOURCE Solutions

-  Global Sourcing Solution
-  Obsolete Management
-  Cost Control Management
-  Shortage Management
-  Alternative Solution
-  Excess Inventory Management