



**THE DATASHEET OF  
AS211-334**



**DATA SHEET**

# AS211-334: 0.1 to 4.0 GHz pHEMT SPDT Switch

## Applications

- General purpose switch for telecommunications

## Features

- P1dB: +30 dBm typical @ 3 V
- IP3: +43 dBm typical @ 3 V
- Low insertion loss: 0.3 dB @ 0.9 GHz
- Low DC power consumption
- Small footprint, DFN (6-pin, 1.2 x 1.5 x 0.75 mm) package (MSL1, 260 °C per JEDEC J-STD-020)



Skyworks Green™ products are compliant with all applicable legislation and are halogen-free. For additional information, refer to *Skyworks Definition of Green™*, document number SQ04-0074.

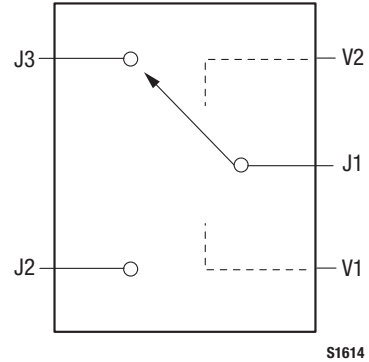
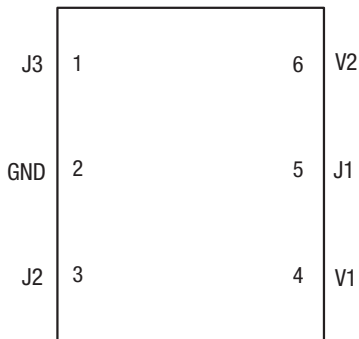

**Figure 1. AS211-334 Block Diagram**

## Description

The AS211-334 is an FET single-pole, double-throw (SPDT) switch for general telecommunications applications. The device features low insertion loss and positive voltage operation with very low DC power consumption.

The switch is manufactured in a compact, 1.2 x 1.5 x 0.75 mm, 6-pin Dual Flat No Lead (DFN) package. A functional block diagram is shown in Figure 1. The pin configuration and package are shown in Figure 2. Signal pin assignments and functional pin descriptions are provided in Table 1.



**Figure 2. AS211-334 Pinout – 6-Pin DFN (Top View)**

**Table 1. AS211-334 Signal Descriptions**

Pin	Name	Description	Pin	Name	Description
1	J3	RF output	4	V1	Positive control voltage
2	GND	Ground	5	J1	RF common/antenna port
3	J2	RF output	6	V2	Positive control voltage

**Table 2. AS211-334 Absolute Maximum Ratings**

Parameter	Symbol	Test Condition	Minimum	Typical	Maximum	Units
Input power	P <sub>IN</sub>	Any frequency >500 MHz, V <sub>CTL</sub> = 0/7 V			6	W
Control voltage	V <sub>CTL</sub>		-0.2		+8.0	V
Operating temperature	T <sub>OP</sub>		-40		+85	°C
Storage temperature	T <sub>STG</sub>		-65		+150	°C

**Note:** Exposure to maximum rating conditions for extended periods may reduce device reliability. There is no damage to device with only one parameter set at the limit and all other parameters set at or below their nominal value. Exceeding any of the limits listed here may result in permanent damage to the device.

---

**CAUTION:** Although this device is designed to be as robust as possible, electrostatic discharge (ESD) can damage this device. This device must be protected at all times from ESD. Static charges may easily produce potentials of several kilovolts on the human body or equipment, which can discharge without detection. Industry-standard ESD precautions should be used at all times.

---

**Electrical and Mechanical Specifications**

The absolute maximum ratings of the AS211-334 are provided in Table 2. Electrical specifications are provided in Table 3.

Typical performance characteristics of the AS211-334 are illustrated in Figures 3 through 5.

The state of the AS211-334 is determined by the logic provided in Table 4.

**Table 3. AS211-334 Electrical Specifications (Note 1)**  
**(Characteristic Impedance [Z<sub>0</sub>] = 50 Ω, Unless Otherwise Noted)**

Parameter	Symbol	Test Condition	Min	Typical	Max	Units
Insertion loss	IL	0.1 to 1.0 GHz		0.3	0.5	dB
		1.0 to 2.0 GHz		0.4	0.6	dB
		2.0 to 3.0 GHz		0.5	0.7	dB
		3.0 to 4.0 GHz		0.6	0.8	dB
Isolation	ISO	0.1 to 1.0 GHz	22	25		dB
		1.0 to 2.0 GHz	20	22		dB
		2.0 to 3.0 GHz	20	23		dB
		3.0 to 4.0 GHz	23	26		dB
Voltage Standing Wave Ratio	VSWR	Low frequency to 4 GHz		1.2:1	1.3:1	–
Switching characteristics: Rise, fall On, off  Video feedthrough		10/90% or 90/10% RF 50% control to 90/10% RF  T <sub>RISE</sub> = 1 ns, bandwidth = 500 MHz		10		ns
				20		ns
				25		mV
1 dB input compression point	IP1dB	V <sub>CTL</sub> = 0 and 3 V, 0.5 to 3.0 GHz V <sub>CTL</sub> = 0 and 5 V 0.5 to 3.0 GHz		+30		dBm
				+34		dBm
3 <sup>rd</sup> Order Input Intercept Point	IIP3	Two-tone P <sub>IN</sub> = +5 dBm  V <sub>CTL</sub> = 0 and 3 V V <sub>CTL</sub> = 0 and 5 V		+43 +50		dBm dBm
Thermal resistance	Θ <sub>JC</sub>			25		°C/W
Control voltage: Low High	V <sub>CTL_L</sub> V <sub>CTL_H</sub>	V <sub>CTL_L</sub> = 0 to 0.2 V @ 20 μA max. V <sub>CTL_H</sub> = 3 V @ 100 μA max. to 5 V @ 200 μA max.				

**Note 1:** Performance is guaranteed only under the conditions listed in this table.

**Typical Performance Characteristics**

**(V<sub>CTL</sub> = 3 V, C<sub>BL</sub> = 47 pF, Characteristic Impedance [Z<sub>0</sub>] = 50 Ω, Unless Otherwise Noted)**

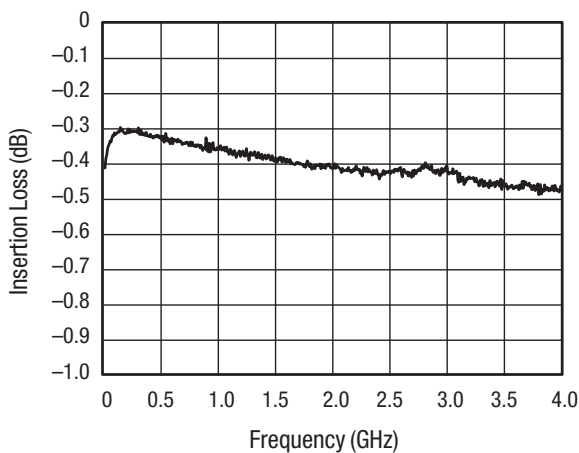

**Figure 3. Insertion Loss vs Frequency**

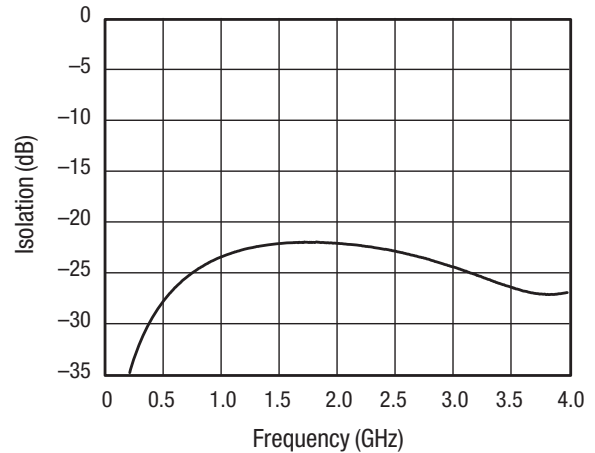

**Figure 4. Isolation vs Frequency**

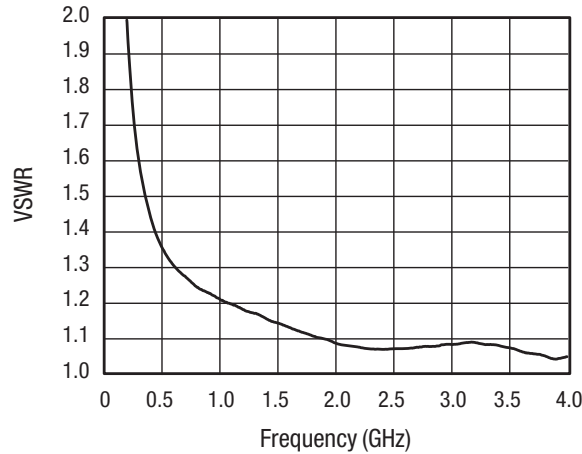

Figure 5. VSWR vs Frequency

Table 4. AS211-334 Truth Table

V1 (Pin 4)	V2 (Pin 6)	J1 to J2 Path	J1 to J3 Path
0	V <sub>HIGH</sub>	Insertion loss	Isolation
V <sub>HIGH</sub>	0	Isolation	Insertion loss

Note: V<sub>HIGH</sub> = +3 V to +5 V. "0" = 0 V to +0.2 V. Any state other than described in this Table places the switch into an undefined state. An undefined state will not damage the device.

### Evaluation Board Description

The AS211-334 Evaluation Board is used to test the performance of the AS211-334 SPDT Switch. An assembly drawing for the Evaluation Board is shown in Figure 6. The Evaluation Board schematic diagram is provided in Figure 7.

### Package Dimensions

The PCB layout footprint for the AS211-334 is provided in Figure 8. Typical case markings are shown in Figure 9. Package dimensions for the 6-pin DFN are shown in Figure 10, and tape and reel dimensions are provided in Figure 11.

### Package and Handling Information

Instructions on the shipping container label regarding exposure to moisture after the container seal is broken must be followed. Otherwise, problems related to moisture absorption may occur when the part is subjected to high temperature during solder assembly.

The AS211-334 is rated to Moisture Sensitivity Level 1 (MSL1) at 260 °C. It can be used for lead or lead-free soldering.

Care must be taken when attaching this product, whether it is done manually or in a production solder reflow environment. Production quantities of this product are shipped in a standard tape and reel format. For packaging details, refer to the Skyworks Application Note, *Discrete Devices and IC Switch/Attenuators Tape and Reel Package Orientation*, document number 200083.

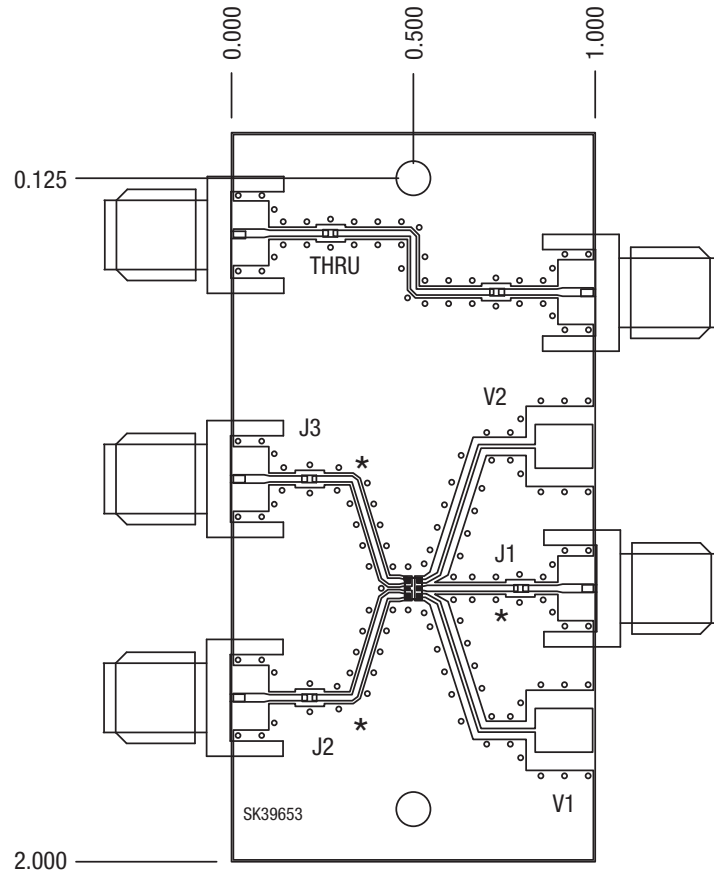

Dimensions are in millimeters

S1837

Figure 6. AS211-334 Evaluation Board Assembly Diagram

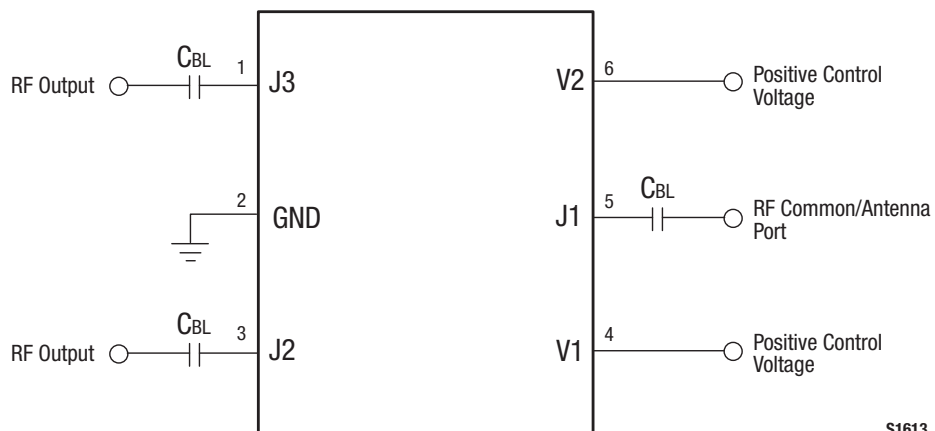

S1613

Figure 7. AS211-334 Evaluation Board Schematic

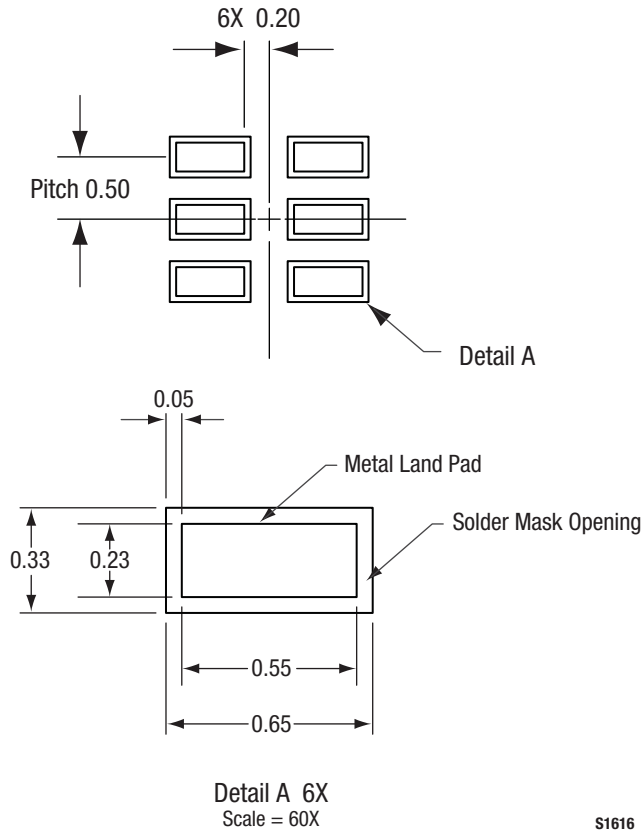

**Figure 8. AS211-334 PCB Layout Footprint (Top View)**

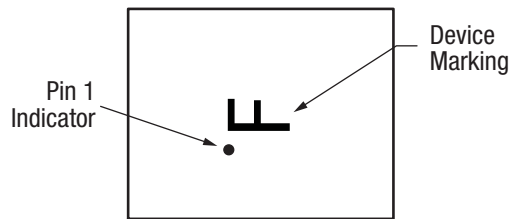

**Figure 9. Typical Part Markings (Top View)**

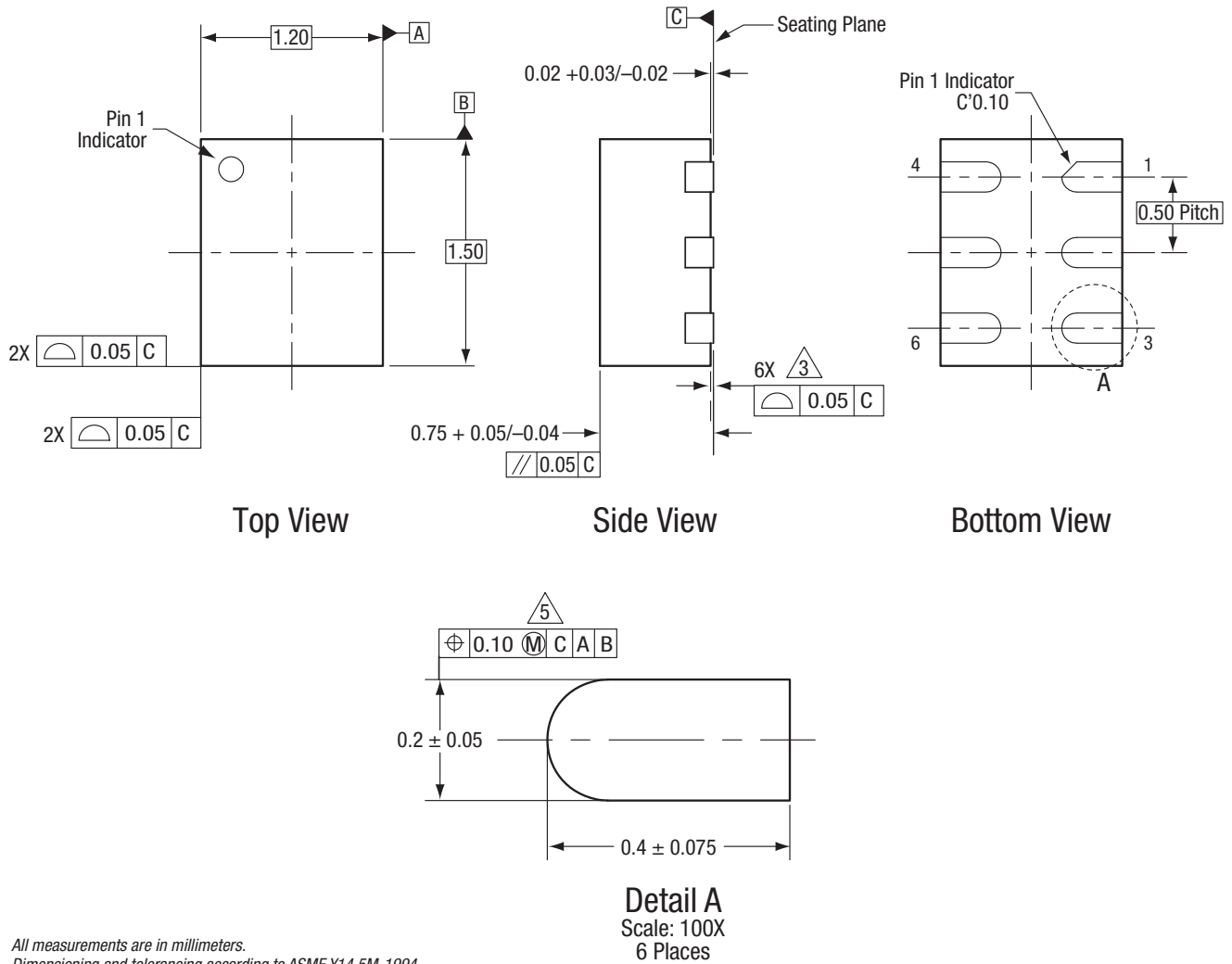

All measurements are in millimeters.  
 Dimensioning and tolerancing according to ASME Y14.5M-1994.  
 Coplanarity applies to the terminals and all other bottom surface metalization.  
 Dimension applies to metalized terminal. If the terminal has a radius on its end,  
 the width dimension should not be measured in that radius area.

S3037

Figure 10. AS211-334 6-Pin DFN Package Dimensions

**DATA SHEET • AS211-334: SPDT SWITCH**

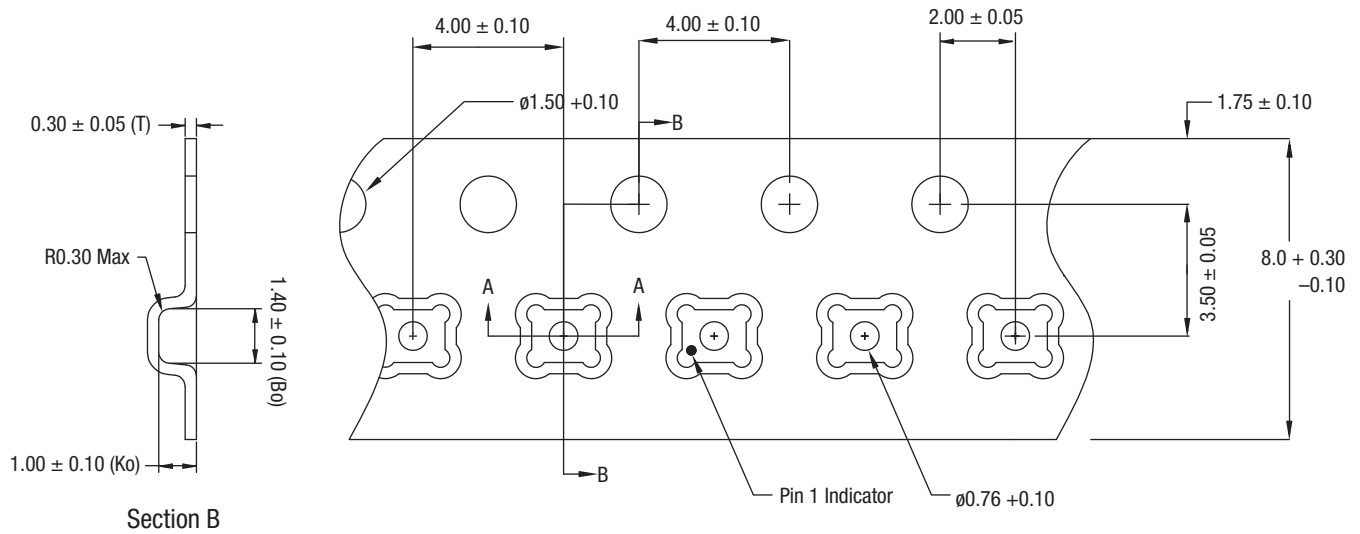

**Notes:**

1. Carrier tape: black conductive polystyrene or polycarbonate.
2. Cover tape: transparent conductive material.
3. ESD surface resistivity shall meet GP01-D232.
4. Ao and Bo measurement point is 0.30 mm from bottom pocket.
5. 10-sprocket hole pitch cumulative tolerance: ±0.20 mm.
6. All dimensions are in millimeters.

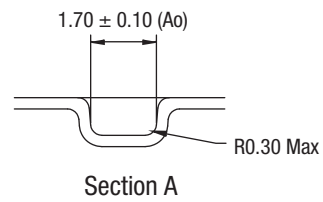

Y1045

**Figure 11. AS211-334 Tape and Reel Dimensions**

**Ordering Information**

Model Name	Manufacturing Part Number	Evaluation Board Part Number
AS211-334: SPDT Switch	AS211-334	AS211-334 EVB

Copyright © 2008-2009, 2012, 2014 Skyworks Solutions, Inc. All Rights Reserved.

Information in this document is provided in connection with Skyworks Solutions, Inc. ("Skyworks") products or services. These materials, including the information contained herein, are provided by Skyworks as a service to its customers and may be used for informational purposes only by the customer. Skyworks assumes no responsibility for errors or omissions in these materials or the information contained herein. Skyworks may change its documentation, products, services, specifications or product descriptions at any time, without notice. Skyworks makes no commitment to update the materials or information and shall have no responsibility whatsoever for conflicts, incompatibilities, or other difficulties arising from any future changes.

No license, whether express, implied, by estoppel or otherwise, is granted to any intellectual property rights by this document. Skyworks assumes no liability for any materials, products or information provided hereunder, including the sale, distribution, reproduction or use of Skyworks products, information or materials, except as may be provided in Skyworks Terms and Conditions of Sale.

THE MATERIALS, PRODUCTS AND INFORMATION ARE PROVIDED "AS IS" WITHOUT WARRANTY OF ANY KIND, WHETHER EXPRESS, IMPLIED, STATUTORY, OR OTHERWISE, INCLUDING FITNESS FOR A PARTICULAR PURPOSE OR USE, MERCHANTABILITY, PERFORMANCE, QUALITY OR NON-INFRINGEMENT OF ANY INTELLECTUAL PROPERTY RIGHT; ALL SUCH WARRANTIES ARE HEREBY EXPRESSLY DISCLAIMED. SKYWORKS DOES NOT WARRANT THE ACCURACY OR COMPLETENESS OF THE INFORMATION, TEXT, GRAPHICS OR OTHER ITEMS CONTAINED WITHIN THESE MATERIALS. SKYWORKS SHALL NOT BE LIABLE FOR ANY DAMAGES, INCLUDING BUT NOT LIMITED TO ANY SPECIAL, INDIRECT, INCIDENTAL, STATUTORY, OR CONSEQUENTIAL DAMAGES, INCLUDING WITHOUT LIMITATION, LOST REVENUES OR LOST PROFITS THAT MAY RESULT FROM THE USE OF THE MATERIALS OR INFORMATION, WHETHER OR NOT THE RECIPIENT OF MATERIALS HAS BEEN ADVISED OF THE POSSIBILITY OF SUCH DAMAGE.



Skyworks products are not intended for use in medical, lifesaving or life-sustaining applications, or other equipment in which the failure of the Skyworks products could lead to personal injury, death, physical or environmental damage. Skyworks customers using or selling Skyworks products for use in such applications do so at their own risk and agree to fully indemnify Skyworks for any damages resulting from such improper use or sale.

Customers are responsible for their products and applications using Skyworks products, which may deviate from published specifications as a result of design defects, errors, or operation of products outside of published parameters or design specifications. Customers should include design and operating safeguards to minimize these and other risks. Skyworks assumes no liability for applications assistance, customer product design, or damage to any equipment resulting from the use of Skyworks products outside of stated published specifications or parameters.

Skyworks and the Skyworks symbol are trademarks or registered trademarks of Skyworks Solutions, Inc., in the United States and other countries. Third-party brands and names are for identification purposes only, and are the property of their respective owners. Additional information, including relevant terms and conditions, posted at [www.skyworksinc.com](http://www.skyworksinc.com), are incorporated by reference.

## Looking for pricing, stock, or lifecycle information?

Click below to explore more details on WIN SOURCE:

-  [View AS211-334 on WIN SOURCE](#)
-  [Skyworks Solutions Inc. Information](#)

## Optimize Your Supply Chain with WIN SOURCE Solutions

-  Global Sourcing Solution
-  Obsolete Management
-  Cost Control Management
-  Shortage Management
-  Alternative Solution
-  Excess Inventory Management