



# THE DATASHEET OF HMC425ALP3ETR



**0.5 dB LSB GaAs MMIC 6-BIT DIGITAL  
POSITIVE CONTROL ATTENUATOR, 2.2 - 8.0 GHz**

**Typical Applications**

The HMC425ALP3E is ideal for:

- WLAN & Point-to-Multi-Point
- Fiber Optics & Broadband Telecom
- Microwave Radio & VSAT
- Military

**Features**

- 0.5 dB LSB Steps to 31.5 dB
- Single Control Line Per Bit
- ± 0.5 dB Typical Bit Error
- Single +5V Supply
- 3x3 mm SMT Package

**Functional Diagram**

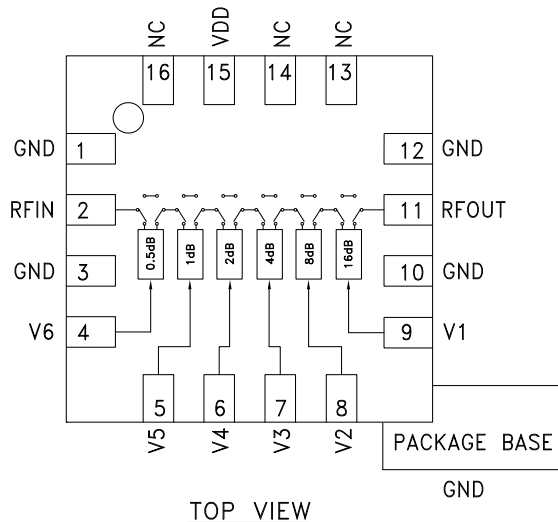

**General Description**

HMC425ALP3E are broadband 6-bit GaAs IC digital attenuators in low cost leadless surface mount packages. Covering 2.2 GHz to 8.0 GHz, the insertion loss is less than 4.5 dB typical. The attenuator bit values are 0.5 (LSB), 1, 2, 4, 8, and 16 dB for a total attenuation of 31.5 dB. Attenuation accuracy is excellent at ± 0.5 dB typical step error with an IIP3 of +40 dBm. Six control voltage inputs, toggled between 0 and +3 to +5V, are used to select each attenuation state. A single VDD bias of +3 to +5V is required.

**Electrical Specifications**

**$T_A = +25^\circ C$ , With  $VDD = +5V$  &  $VCTL = 0/+5V$  (Unless Otherwise Noted)**

| Parameter  | Frequency  | Min.                                | Typ.       | Max.     | Units      |
|--|--|-------------------------------------|------------|----------|------------|
| Insertion Loss   | 2.2 - 6.0 GHz<br>6.0 - 8.0 GHz                                 |                                     | 3.5<br>4.5 | 4<br>4.7 | dB<br>dB   |
| Attenuation Range  | 2.2 - 8.0 GHz  |                                     | 31.5       |          | dB         |
| Return Loss (RF1 & RF2, All Atten. States)                                   | 2.2 - 8.0 GHz  |                                     | 15         |          | dB         |
| Attenuation Accuracy<br>(Referenced to Insertion Loss)                       | All States<br>2.2 - 8.0 GHz                                    | ± (0.5 + 5% of Atten. Setting Max.) |            |          | dB         |
| Input Power for 0.1 dB Compression   | VDD= 5V<br>VDD = 3V<br>2.2 - 8.0 GHz                           |                                     | 25<br>23   |          | dBm<br>dBm |
| Input Third Order Intercept Point<br>(Two-Tone Input Power= 0 dBm Each Tone) | REF - 16.0 dB States<br>16.5 - 31.5 dB States<br>2.2 - 8.0 GHz |                                     | 45<br>40   |          | dBm<br>dBm |
| Switching Characteristics  | 2.2 - 8.0 GHz  |                                     |            |          |            |
| $t_{RISE}, t_{FALL}$ (10/90% RF)   |  |                                     | 400        |          | ns         |
| $t_{ON}, t_{OFF}$ (50% CTL to 10/90% RF)                                     |  |                                     | 420        |          | ns         |

**0.5 dB LSB GaAs MMIC 6-BIT DIGITAL POSITIVE CONTROL ATTENUATOR, 2.2 - 8.0 GHz**

**Insertion Loss**

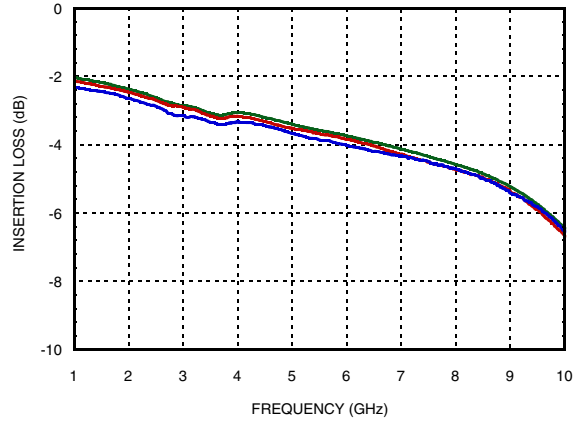

**Return Loss RF1, RF2**  
(Only Major States are Shown)

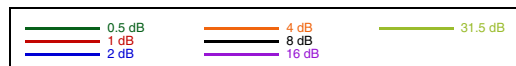
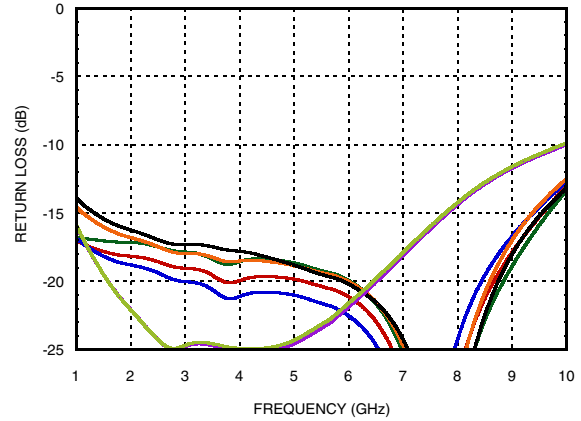

**Normalized Attenuation**  
(Only Major States are Shown)

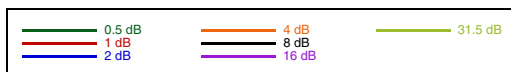
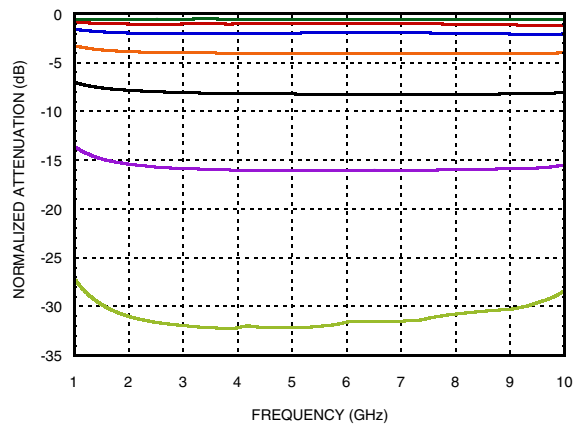

**Bit Error vs. Attenuation State**

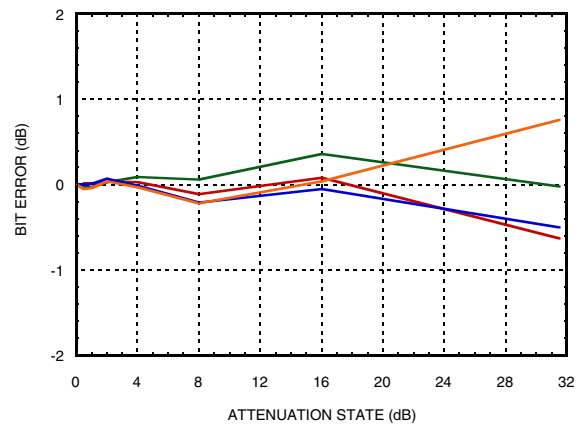

**Bit Error vs. Frequency**  
(Only Major States are Shown)

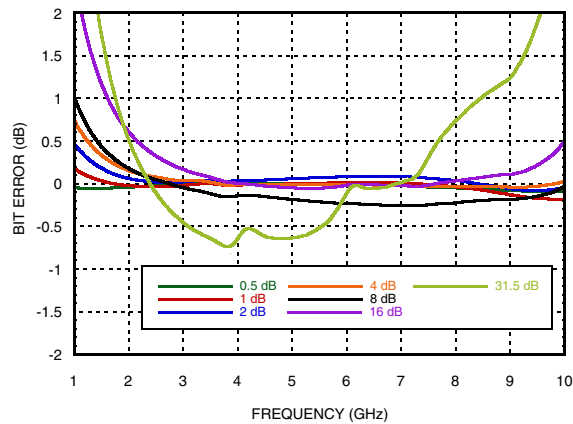

**Relative Phase vs. Frequency**  
(Only Major States are Shown)

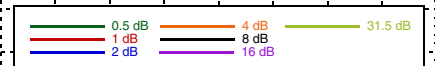
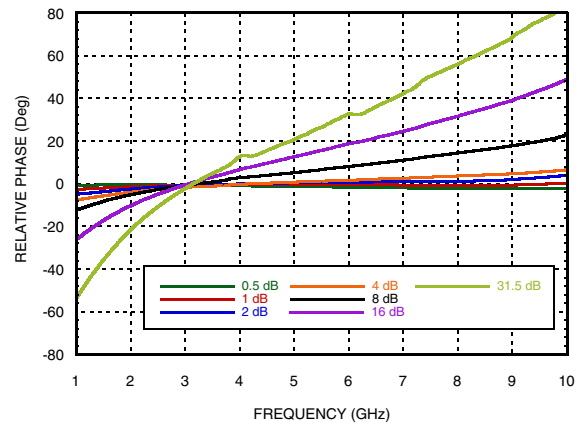

**0.5 dB LSB GaAs MMIC 6-BIT DIGITAL POSITIVE CONTROL ATTENUATOR, 2.2 - 8.0 GHz**

**Worst Case Step Error Between Successive Attenuation States**

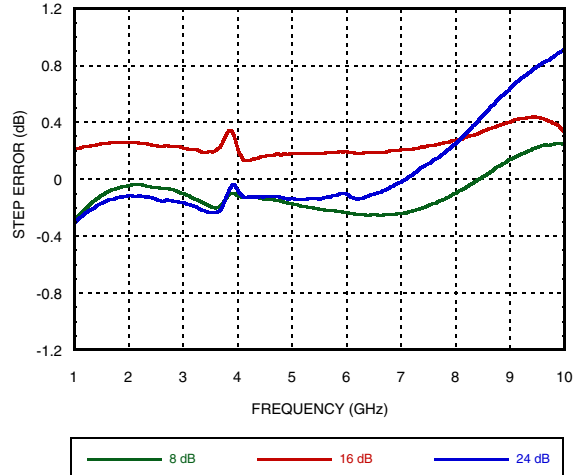

**P0.1dB vs. Temperature, IL State**

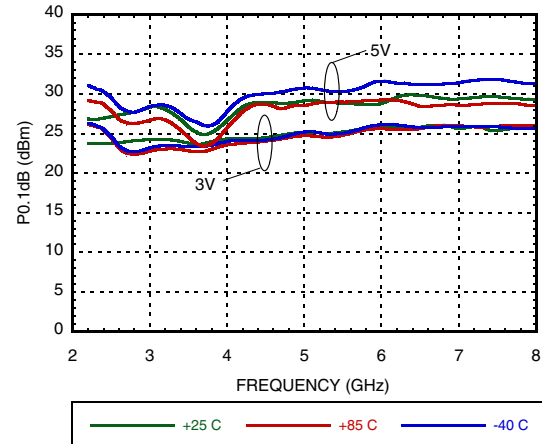

**IIP3 vs. Frequency at VDD=3V**

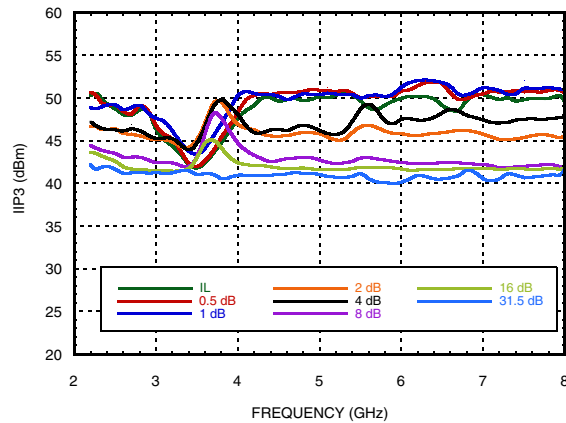

**IIP3 vs. Frequency at VDD=5V**

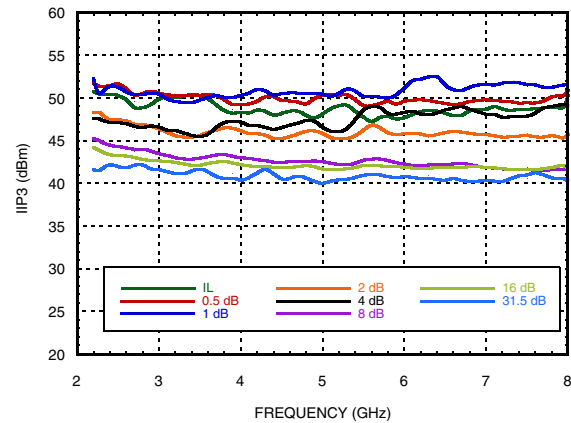

**Truth Table**

| Control Voltage Input |            |            |            |            |              | Attenuation State<br>RF1 - RF2 |
|-----------------------|------------|------------|------------|------------|--------------|--------------------------------|
| V1<br>16 dB           | V2<br>8 dB | V3<br>4 dB | V4<br>2 dB | V5<br>1 dB | V6<br>0.5 dB |                                |
| High                  | High       | High       | High       | High       | High         | Reference I.L.                 |
| High                  | High       | High       | High       | High       | Low          | 0.5 dB                         |
| High                  | High       | High       | High       | Low        | High         | 1 dB                           |
| High                  | High       | High       | Low        | High       | High         | 2 dB                           |
| High                  | High       | Low        | High       | High       | High         | 4 dB                           |
| High                  | Low        | High       | High       | High       | High         | 8 dB                           |
| Low                   | High       | High       | High       | High       | High         | 16 dB                          |
| Low                   | Low        | Low        | Low        | Low        | Low          | 31.5 dB                        |

Any combination of the above states will provide an attenuation approximately equal to the sum of the bits selected.

**Bias Voltage & Current**

| VDD Range = +3.0 V to +5.0 V |            |
|------------------------------|------------|
| VDD (Vdc)                    | IDD (Typ.) |
| +3.0 V                       | 10 $\mu$ A |
| +5.0 V                       | 30 $\mu$ A |

**Control Voltage**

| State | Bias Condition                   |
|-------|----------------------------------|
| Low   | 0 to 0.2V at 10 $\mu$ A Typ.     |
| High  | VDD $\pm$ 0.2V at 5 $\mu$ A Typ. |

Note: VDD = +3V to +5V

## 0.5 dB LSB GaAs MMIC 6-BIT DIGITAL POSITIVE CONTROL ATTENUATOR, 2.2 - 8.0 GHz

### Absolute Maximum Ratings

|                                |                |
|--------------------------------|----------------|
| Control Voltage (V1 to V6)     | VDD +0.5 Vdc   |
| Supply Voltage (VDD)           | +7.0 Vdc       |
| Storage Temperature            | -65 to +150 °C |
| Operating Temperature          | -40 to +85 °C  |
| RF Input Power (2.2 - 8.0 GHz) | +27 dBm        |
| ESD Sensitivity (HBM)          | Class 1A       |
| ESD Sensitivity (FICDM)        | Class IV       |



ELECTROSTATIC SENSITIVE DEVICE  
OBSERVE HANDLING PRECAUTIONS

### Outline Drawing



16-Lead Lead Frame Chip Scale Package [LFCSP]  
3 x 3 mm Body and 0.85 mm Package Height  
(CP-16-50)  
Dimensions shown in millimeters

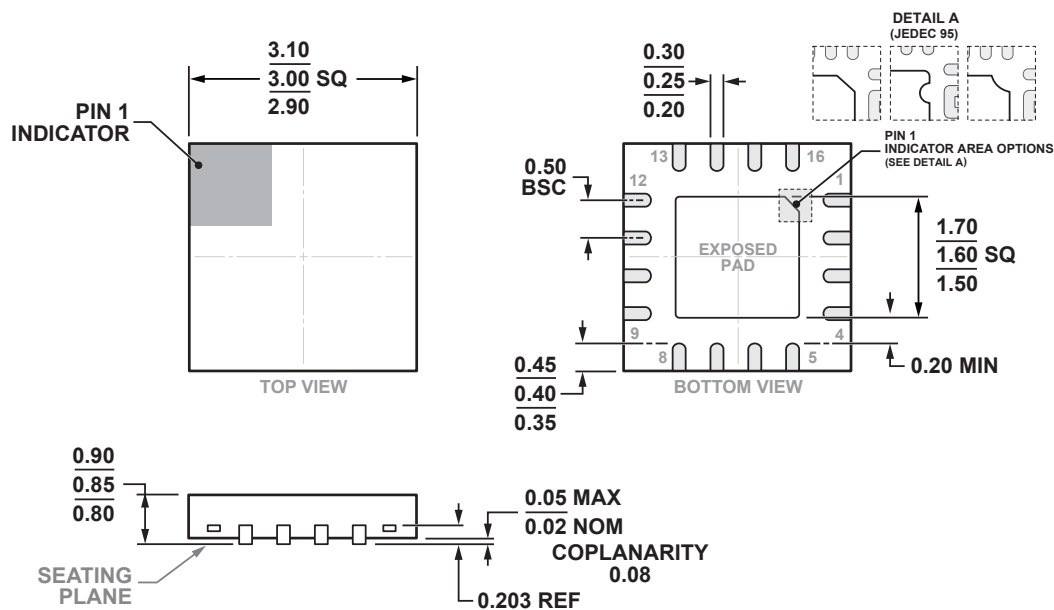

COMPLIANT TO JEDEC STANDARDS MO-220-VEED-4

### Package Information

| Part Number | Package Body Material                              | Lead Finish   | MSL Rating          | Package Marking <sup>[2]</sup> |
|-------------|--|---------------|---------------------|--------------------------------|
| HMC425ALP3E | RoHS-compliant Low Stress Injection Molded Plastic | 100% Matte Sn | MSL3 <sup>[1]</sup> | H425A<br>XXXX                  |

[1] Max peak reflow temperature of 260 °C

[2] 4-Digit lot number XXXX

**0.5 dB LSB GaAs MMIC 6-BIT DIGITAL  
POSITIVE CONTROL ATTENUATOR, 2.2 - 8.0 GHz**

**Pin Descriptions**

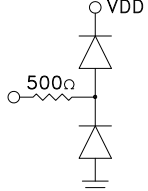
| Pin Number       | Function    | Description  | Interface Schematic   |
|------------------|-------------|--|---|
| 1, 3, 10, 12     | GND         | Package bottom has an exposed metal paddle that must also be connected to RF ground. |  |
| 2, 11            | RFIN, RFOUT | This pin is DC coupled and matched to 50 Ohm. Blocking capacitors are required.      |   |
| 4, 5, 6, 7, 8, 9 | V1 - V6     | See truth table and control voltage table.   |  |
| 13, 14, 16       | NC          | This pin should be connected to PCB RF ground to maximize performance.               |   |
| 15               | VDD         | Supply Voltage   |   |

**Evaluation PCB Schematic**

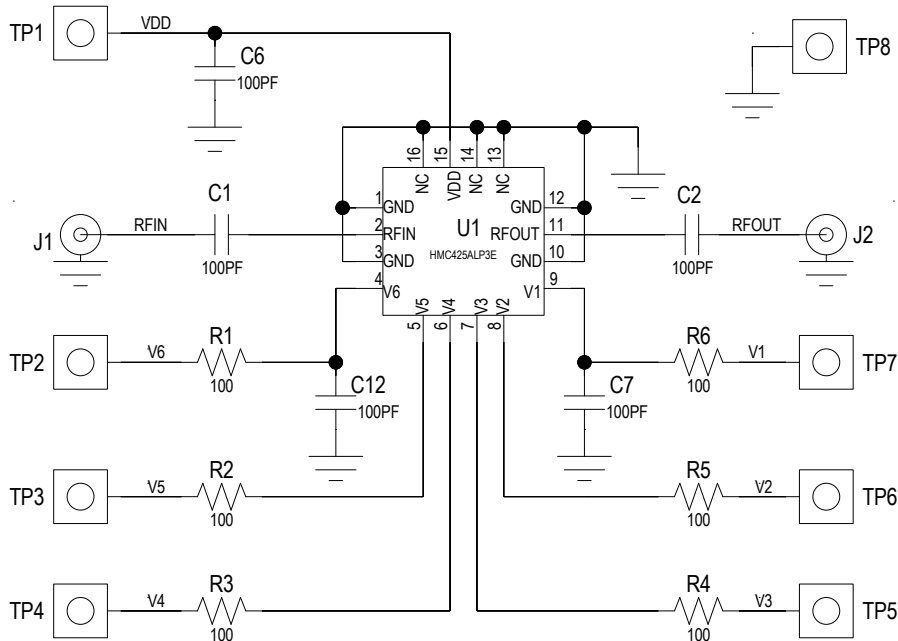

**0.5 dB LSB GaAs MMIC 6-BIT DIGITAL  
POSITIVE CONTROL ATTENUATOR, 2.2 - 8.0 GHz**

**Evaluation PCB Layout**

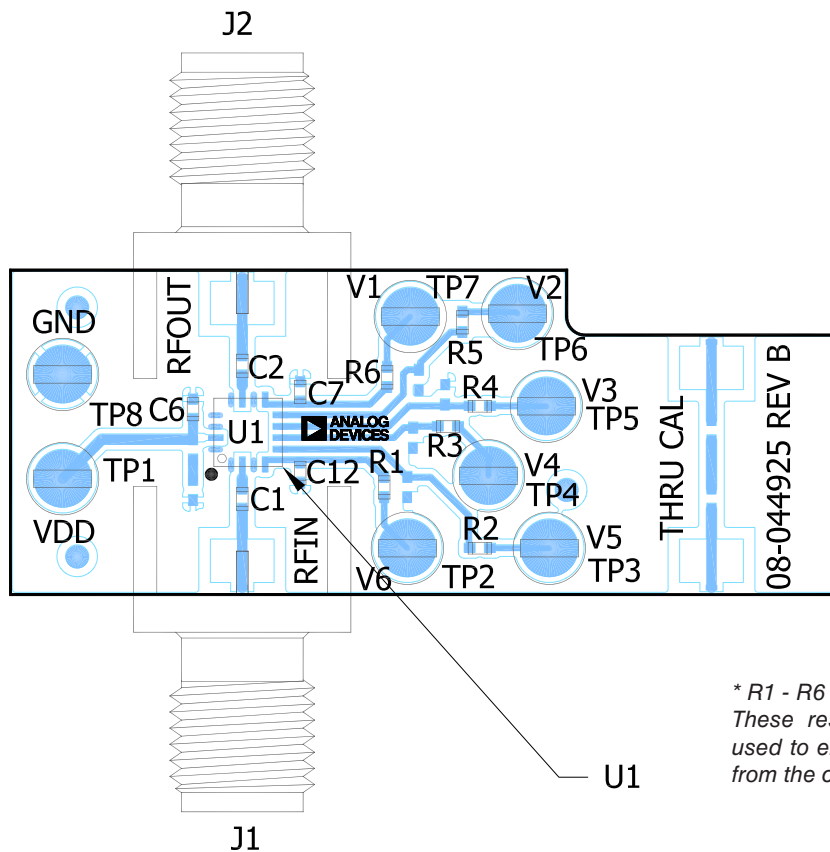

\* R1 - R6 = 100 Ohm.  
These resistors are optional and may be used to enhance decoupling of the RF path from the control inputs.

**List of Materials for Evaluation PCB EV1HMC425ALP3E [1]**

| Item               | Description                    |
|--------------------|--------------------------------|
| J1 - J2            | PCB Mount SMA Connector        |
| TP1-TP8            | DC Test Point                  |
| C1-C2, C6, C7, C12 | 100 pF Capacitor, 0402 Pkg.    |
| R1 - R6            | 100 Ohm Resistor, 0402 Pkg.    |
| U1                 | HMC425ALP3E Digital Attenuator |
| PCB [2]            | 08-044925 Evaluation PCB       |

[1] Reference this number when ordering complete evaluation PCB

[2] Circuit Board Material: Rogers 4350

The circuit board used in the application should use RF circuit design techniques. Signal lines should have 50 Ohm impedance while the package ground leads and exposed paddle should be connected directly to the ground plane similar to that shown. A sufficient number of via holes should be used to connect the top and bottom ground planes. The evaluation circuit board shown is available from Analog Devices upon request.

## Looking for pricing, stock, or lifecycle information?

Click below to explore more details on WIN SOURCE:

- ⊖ [View HMC425ALP3ETR on WIN SOURCE](#)
- ⊖ [Analog Devices Inc. Information](#)

## Optimize Your Supply Chain with WIN SOURCE Solutions

- ✓ Global Sourcing Solution
- ✓ Obsolete Management
- ✓ Cost Control Management
- ✓ Shortage Management
- ✓ Alternative Solution
- ✓ Excess Inventory Management