

# General Specifications

## Electrical Capacity (Resistive Load)

**Logic Level:** 0.4VA maximum @ 28V AC/DC maximum  
(Applicable Range 0.1mA ~ 0.1A @ 20mV ~ 28V)  
Note: Find additional explanation of operating range in Supplement section.

## Other Ratings

**Contact Resistance:** 50 milliohms maximum  
**Insulation Resistance:** 500 megohms minimum @ 500V DC  
**Dielectric Strength:** 500V AC minimum for 1 minute minimum  
**Mechanical Life:** 50,000 operations minimum  
**Electrical Life:** 50,000 operations minimum  
**Nominal Operating Force:** 2.55N  
**Contact Timing:** Nonshorting (break-before-make)  
**Travel:** Pretravel: .082" (2.1mm); Overtravel: .016" (0.4mm); Total Travel: .098" (2.5mm)

## Materials & Finishes

**Actuator:** Glass fiber reinforced polyamide  
**Upper Case Housing:** Carbon blended polyacetal (antistatic)  
**Lower Case Housing:** Glass fiber reinforced polyamide  
**Support Bracket:** Tin plated phosphor bronze  
**Movable Contact:** Phosphor bronze with gold plating  
**Stationary Contacts:** Brass with gold plating  
**Terminals:** Brass with gold plating

## Environmental Data

**Operating Temperature Range:** -30°C through +85°C (-22°F through +185°F)  
**Humidity:** 90 ~ 95% humidity for 192 hours @ 40°C (104°F)  
**Vibration:** 10 ~ 60Hz with peak-to-peak amplitude of 1.5mm traversing the frequency range & returning in 5 minutes; 3 right angled directions for 30 minutes  
**Shock:** 50G (490m/s<sup>2</sup>) acceleration (tested in 6 right angled directions, with 5 shocks in each direction)

## PCB Processing

**Soldering:** Wave Soldering Recommended. See Profile A in Supplement section.  
Manual Soldering: for single pole see Profile B in Supplement section; for double pole see Profile A.  
**Cleaning:** These devices are not process sealed. Hand clean locally using alcohol based solution.

## Standards & Certifications

The A Series slides have not been tested for UL recognition or CSA certification. These switches are designed for use in a low-voltage, low-current, logic-level circuit. When used as intended in a logic-level circuit, the results do not produce hazardous energy.

Toggle

Rockers

Pushbuttons

Illuminated PB

Programmable

Keylocks

Rotaries

Slides

Tactiles

Tilt

Touch

Indicators

Accessories

Supplement

# Distinctive Characteristics

Subminiature size (1/3 size of Series M switches) saves space on PC boards.

Specifically developed for logic-level applications.

Award-winning STC contact mechanism with benefits unavailable in conventional mechanisms: smoother, positive detent actuation, increased contact stability and unparalleled logic-level reliability. (Additional STC details in Terms & Acronyms; see Supplement section.)

Available in various actuator lengths.

Antistatic superstructure of carbon blended polyacetal prevents static discharge to the contacts.

Molded-in, epoxy sealed or ultrasonically welded terminals lock out flux, solvents, and other contaminants.

.100" x .100" (2.54mm x 2.54mm) terminal spacing conforms to standard PC board grid spacing.

Matching indicators available.

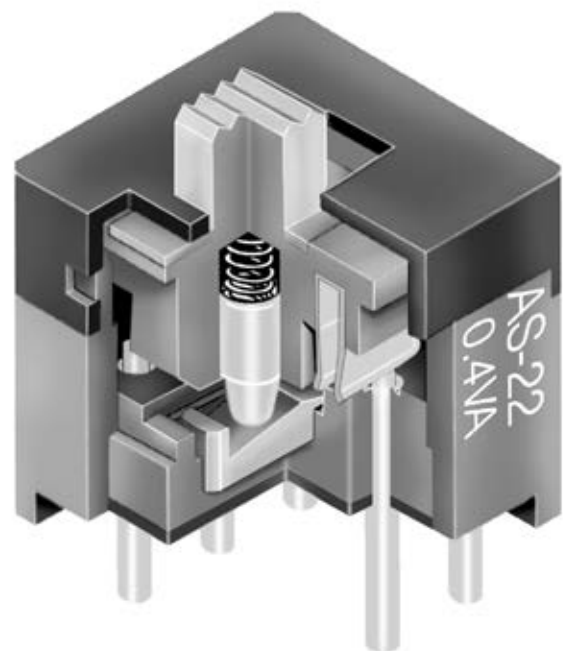

Actual Size

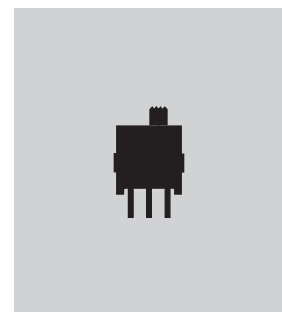

## TYPICAL SWITCH ORDERING EXAMPLE

**AS**      **2**      **2**      **A**      **H**

Poles		Circuits				Actuators		PC Terminals	
1	SPST SPDT	1	ON	NONE	OFF	A	.098" (2.5mm) Long	P	Straight
2	DPDT SP3T	2	ON	NONE	ON	B	Flush	*B	Straight with Bracket
		3	ON	OFF	ON	C	.150" (3.8mm) Long	*H	Right Angle with Bracket
		4	ON	ON	ON			*V	Vertical with Bracket

\*Bracketed models are ESD protected

### DESCRIPTION FOR TYPICAL ORDERING EXAMPLE

**AS22AH**



DPDT  
ON-NONE-ON Circuit

.098" (2.5mm) Long  
Actuator



Right Angle PC Terminals

## POLES & CIRCUITS

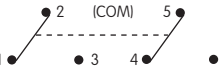
Pole	Model	Slide Position			Connected Terminals			Throw & Schematics
		Left	Center	Right	Left	Center	Right	
SP	AS11	ON	NONE	OFF	3-1	OPEN	OPEN	SPST 
SP	AS12 AS13	ON ON	NONE OFF	ON ON	2-1 2-1	OPEN OPEN	2-3 2-3	SPDT 
DP	AS22 AS23	ON ON	NONE OFF	ON ON	2-1 5-4 2-1 5-4	OPEN OPEN	2-3 5-6 2-3 5-6	DPDT 

Note: Terminal numbers are not actually on the switch.

### For 3 Throw (3-On)

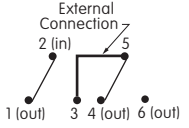
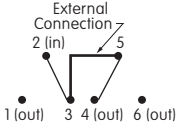
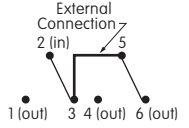
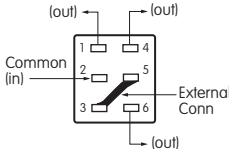
Pole	Model	Connected Terminals & Schematics			External Connection
		Left	Center	Right	
SP	AS24	ON  2-1 5-4	ON  2-3 5-4	ON  2-3 5-6	The SP3T model utilizes a double pole base.  External connections must be made during field installation. 

## ACTUATORS

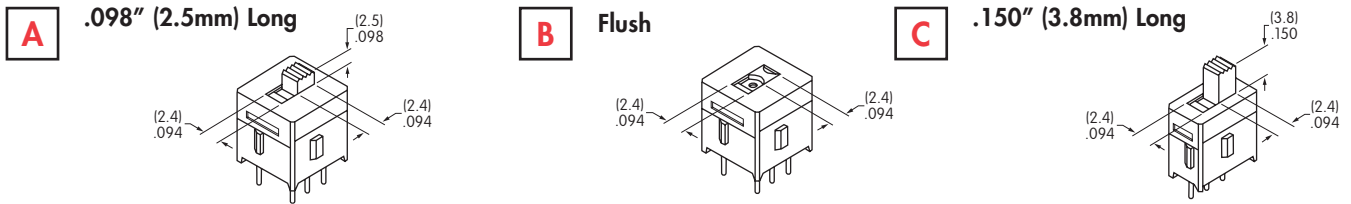

Actuator Color: Gray standard; contact factory for other colors.

## PC TERMINALS

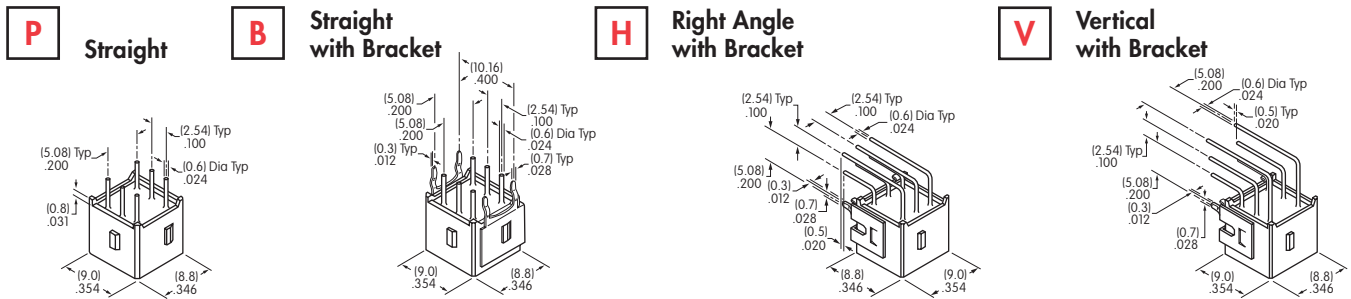

Use of a support bracket is recommended to increase PCB mounting strength and stability.

## TYPICAL SWITCH DIMENSIONS

### Single Pole

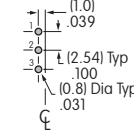
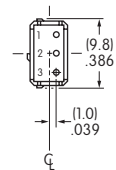
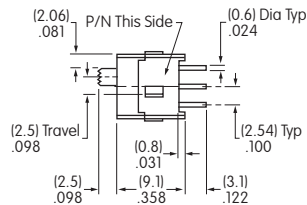
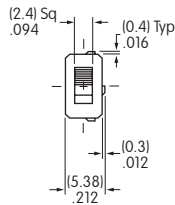

Actuator shown in LEFT position

Single throw models do not have terminal 2.

### Straight PC



**AS12AP**

### Double Pole

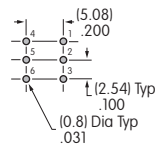
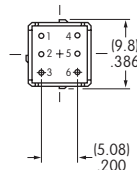
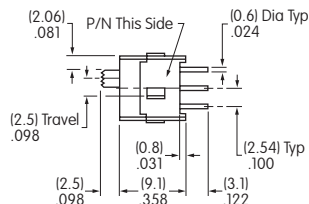
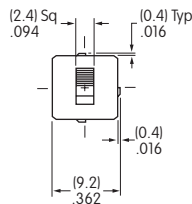

Actuator shown in LEFT position

### Straight PC



**AS22AP**

### Single Pole

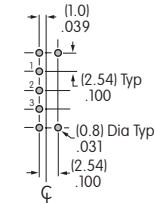
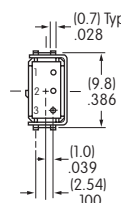
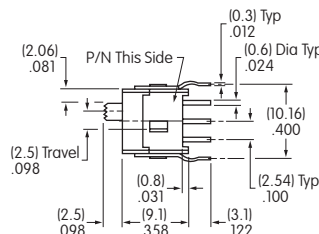
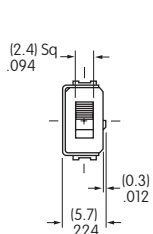

Actuator shown in LEFT position

### Straight PC • Bracket



**AS12AB**

## TYPICAL SWITCH DIMENSIONS

### Straight PC • Bracket

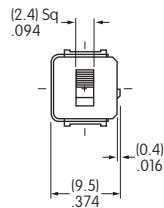

### Double Pole

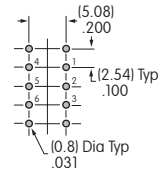
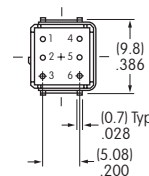
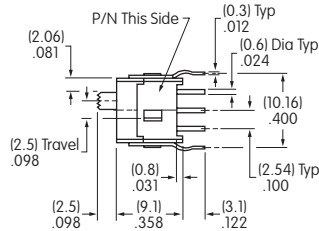

AS22AB

Actuator shown in LEFT position

### Right Angle PC

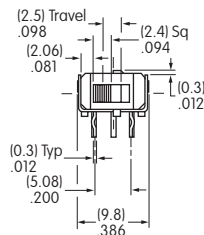

### Single Pole

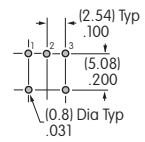
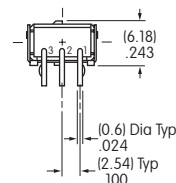
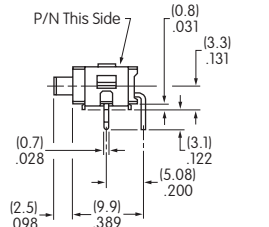

AS12AH

Actuator shown in LEFT position

### Right Angle PC

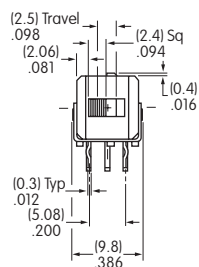

### Double Pole

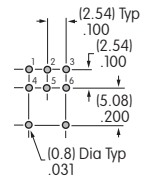
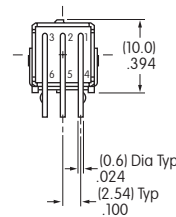
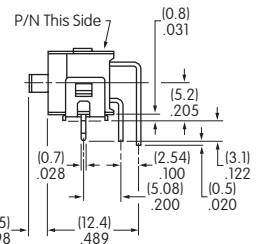

AS22AH

Actuator shown in LEFT position

### Vertical PC

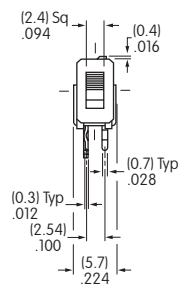

### Single Pole

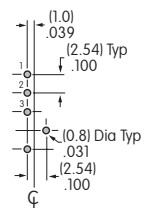
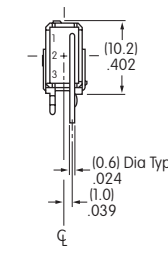
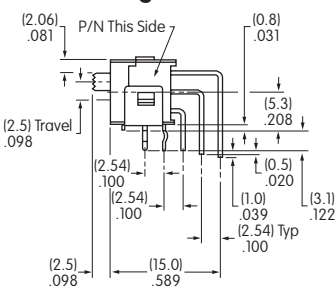

AS12AV

Actuator shown in LEFT position

### Vertical PC

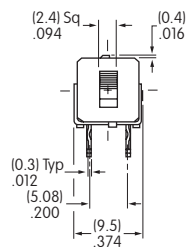

### Double Pole

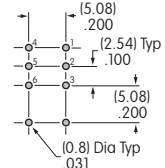
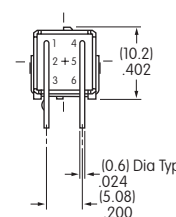
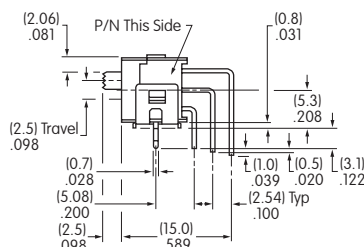

AS22AV

Actuator shown in LEFT position

Toggles  
Rockers  
Pushbuttons  
Illuminated PB  
Programmable  
Keylocks  
Rotaries  
Slides  
Tactiles  
Tilt  
Touch  
Indicators  
Accessories  
Supplement

## Looking for pricing, stock, or lifecycle information?

Click below to explore more details on WIN SOURCE:

- ⊖ [View AS12AH](#) on WIN SOURCE
- ⊖ [NKK Switches](#) Information

## Optimize Your Supply Chain with WIN SOURCE Solutions

- ✓ Global Sourcing Solution
- ✓ Obsolete Management
- ✓ Cost Control Management
- ✓ Shortage Management
- ✓ Alternative Solution
- ✓ Excess Inventory Management