



GaAs MMIC FUNDAMENTAL MIXER, 7 - 14 GHz

Typical Applications

The HMC553LC3B is ideal for:

- Point-to-Point Radios
- Point-to-Multi-Point Radios
- Test Equipment & Sensors
- Military End-Use

Features

- Passive Double Balanced Topology
- High LO/RF Isolation: 50 dB
- Low Conversion Loss: 7 dB
- Wide IF Bandwidth: DC - 5 GHz
- Robust 1,000V ESD, Class 1C
- 12 Lead Ceramic 3x3mm SMT Package: 9mm²

Functional Diagram

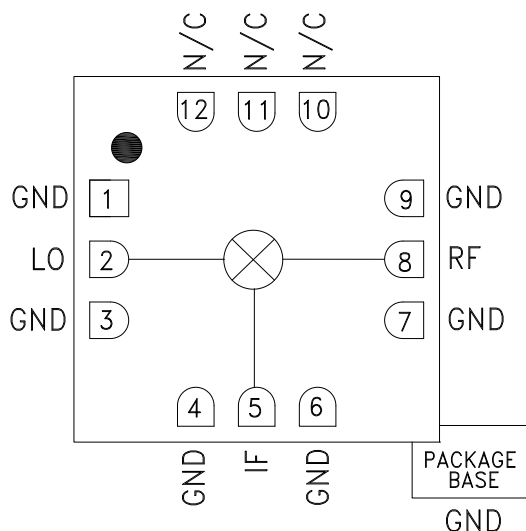

General Description

The HMC553LC3B is a general purpose double balanced mixer in a leadless RoHS compliant SMT package that can be used as an upconverter or downconverter between 7 and 14 GHz. This mixer is fabricated in a GaAs MESFET process, and requires no external components or matching circuitry. The HMC553LC3B provides excellent LO to RF and LO to IF isolation due to optimized balun structures and operates with LO drive levels as low as +9 dBm. The RoHS compliant HMC553LC3B eliminates the need for wire bonding, and is compatible with high volume surface mount manufacturing techniques.

Electrical Specifications, $T_A = +25^\circ\text{C}$, $IF = 100\text{ MHz}$, $LO = +13\text{ dBm}^*$

Parameter	Min.	Typ.	Max.	Min.	Typ.	Max.	Units
Frequency Range, RF & LO	7 - 11		11 - 14				GHz
Frequency Range, IF	DC - 5		DC - 5				GHz
Conversion Loss		7	9.5		8	10	dB
Noise Figure (SSB)		7	9.5		8	10	dB
LO to RF Isolation	40	50		35	45		dB
LO to IF Isolation	28	34		30	36		dB
RF to IF Isolation	15	22		25	30		dB
IP3 (Input)		18			22		dBm
IP2 (Input)		48			48		dBm
1 dB Gain Compression (Input)		10			11.5		dBm

*Unless otherwise noted, all measurements performed as downconverter, $IF = 100\text{ MHz}$.



GaAs MMIC FUNDAMENTAL MIXER, 7 - 14 GHz

Conversion Gain vs. Temperature @ LO = +13 dBm

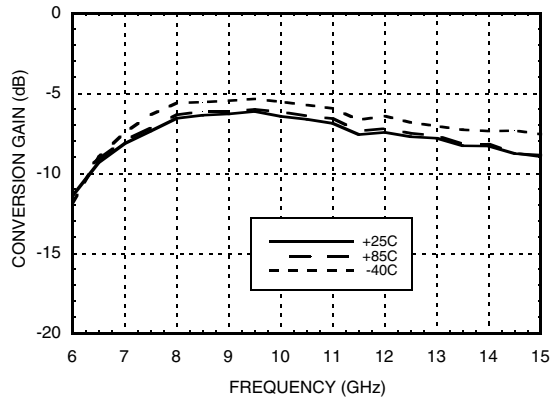

Isolation @ LO = +13 dBm

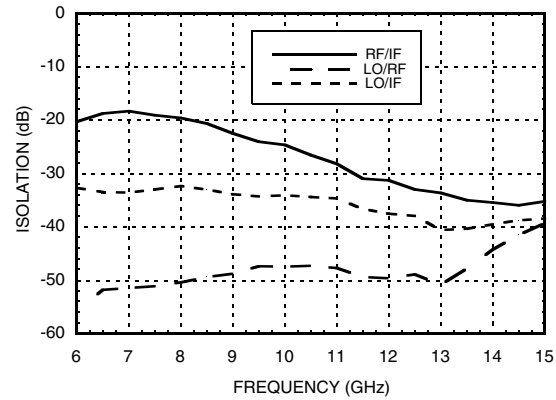

Conversion Gain vs. LO Drive

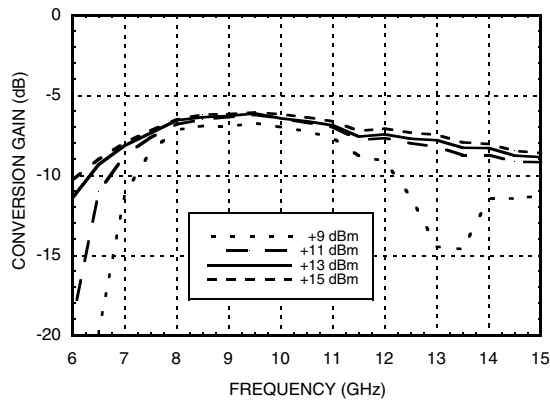

Return Loss @ LO = +13 dBm

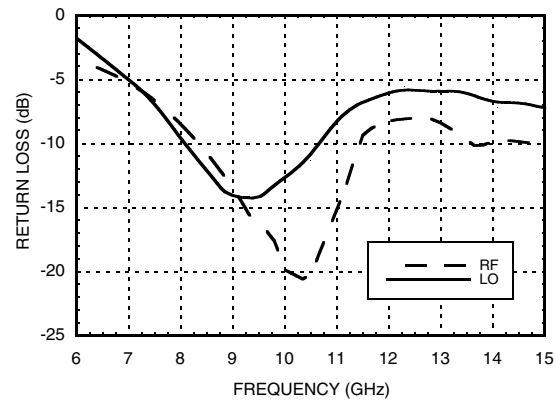

IF Bandwidth @ LO = +13 dBm

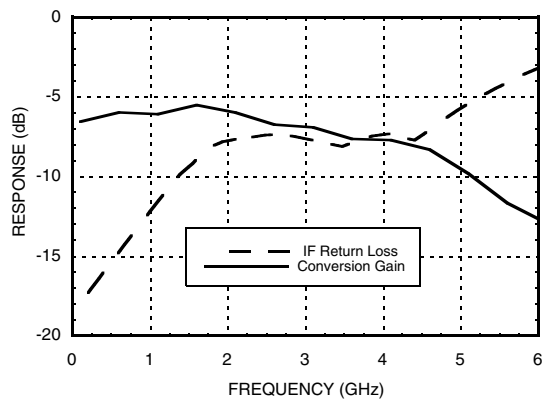

Upconverter Performance Conversion Gain vs. LO Drive

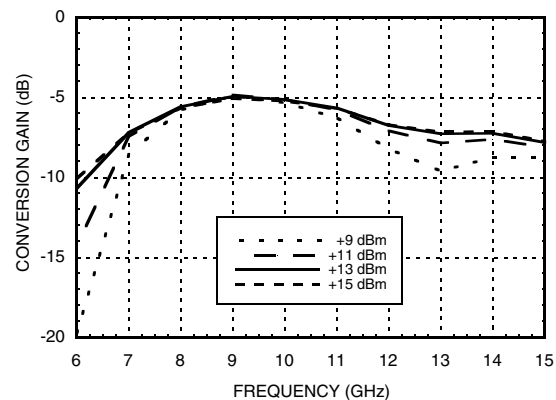

Information furnished by Analog Devices is believed to be accurate and reliable. However, no responsibility is assumed by Analog Devices for its use, nor for any infringements of patents or other rights of third parties that may result from its use. Specifications subject to change without notice. No license is granted by implication or otherwise under any patent or patent rights of Analog Devices. Trademarks and registered trademarks are the property of their respective owners.

For price, delivery, and to place orders: Analog Devices, Inc., One Technology Way, P.O. Box 9106, Norwood, MA 02062-9106 Phone: 781-329-4700 • Order online at www.analog.com Application Support: Phone: 1-800-ANALOG-D



GaAs MMIC FUNDAMENTAL MIXER, 7 - 14 GHz

MIXERS - SINGLE & DOUBLE BALANCED - SMT

Input IP3 vs. LO Drive *

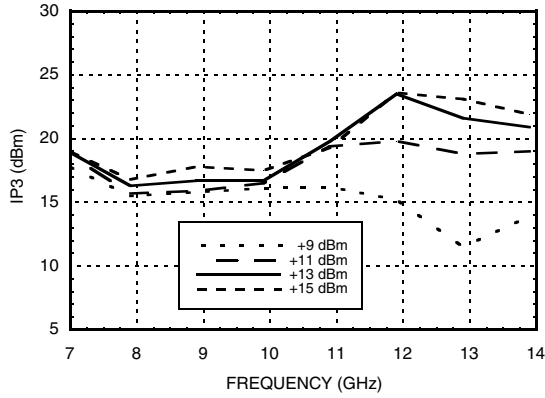

Input IP3 vs. Temperature @ LO = +13 dBm *

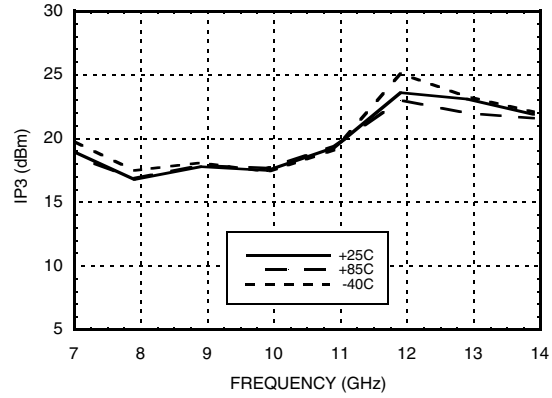

Input IP2 vs. LO Drive *

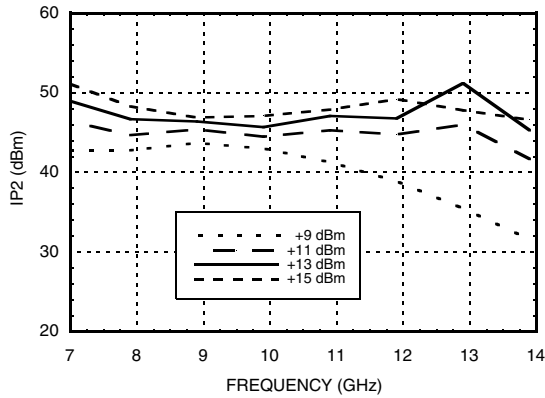

Input IP2 vs. Temperature @ LO = +13 dBm *

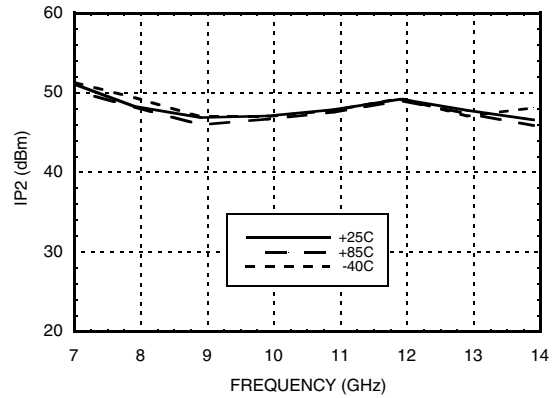

Input P1dB vs. Temperature @ LO = +13 dBm

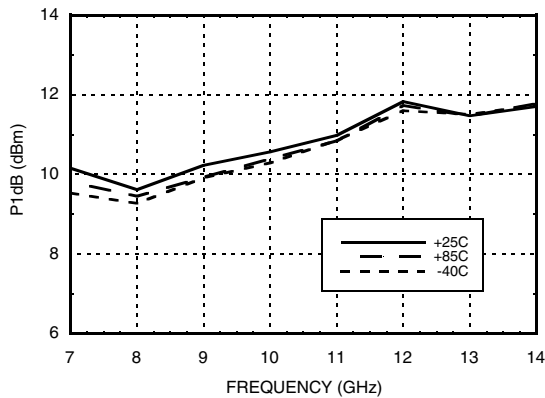

MxN Spurious Outputs

	nLO				
mRF	0	1	2	3	4
0	xx	7	50	38	58
1	22	0	41	53	65
2	100	72	62	73	102
3	103	100	96	71	90
4	xx	105	101	104	111

RF = 10.1 GHz @ -10 dBm
 LO = 10 GHz @ +13 dBm
 All values in dBc below the IF output power level.

* Two-tone input power = -10 dBm each tone, 1 MHz spacing.

Information furnished by Analog Devices is believed to be accurate and reliable. However, no responsibility is assumed by Analog Devices for its use, nor for any infringements of patents or other rights of third parties that may result from its use. Specifications subject to change without notice. No license is granted by implication or otherwise under any patent or patent rights of Analog Devices. Trademarks and registered trademarks are the property of their respective owners.

For price, delivery, and to place orders: Analog Devices, Inc., One Technology Way, P.O. Box 9106, Norwood, MA 02062-9106 Phone: 781-329-4700 • Order online at www.analog.com Application Support: Phone: 1-800-ANALOG-D

**GaAs MMIC FUNDAMENTAL
MIXER, 7 - 14 GHz****Absolute Maximum Ratings**

RF / IF Input	+25 dBm
LO Drive	+25 dBm
Channel Temperature	150 °C
Continuous Pdiss (T = 85 °C) (derate 2.75 mW/°C above 85 °C)	178 mW
Thermal Resistance (channel to ground paddle)	364 °C/W
Storage Temperature	-65 to +150 °C
Operating Temperature	-40 to +85 °C
ESD Sensitivity (HBM)	Class 1C

**ELECTROSTATIC SENSITIVE DEVICE
OBSERVE HANDLING PRECAUTIONS**



**GaAs MMIC FUNDAMENTAL
MIXER, 7 - 14 GHz**

Outline Drawing

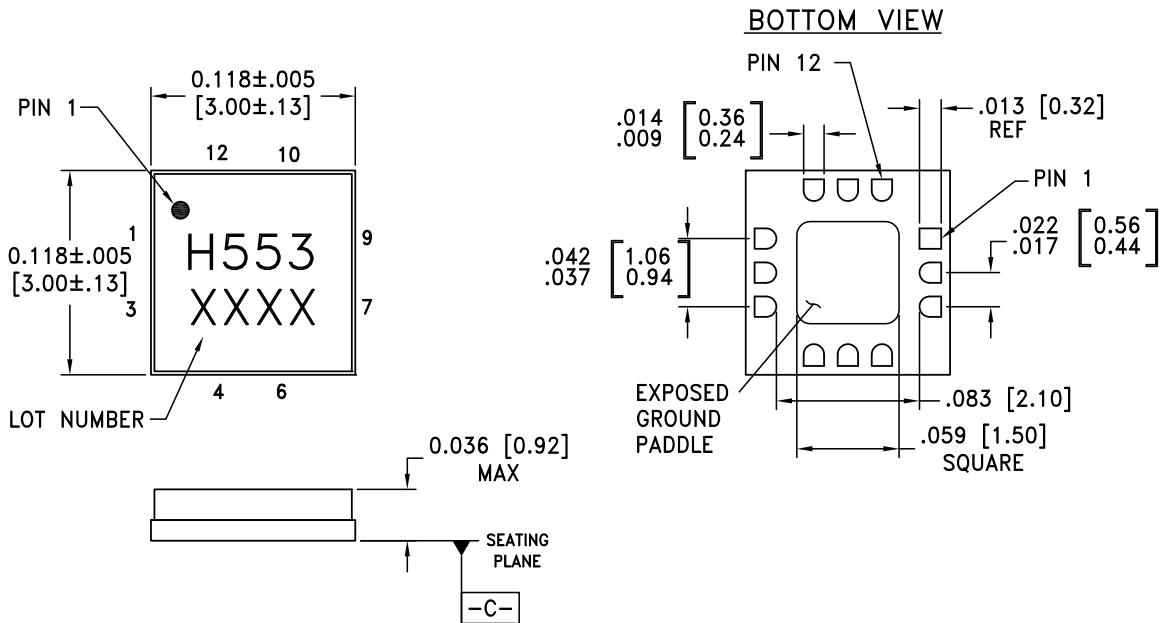

NOTES:

1. PACKAGE BODY MATERIAL: ALUMINA.
2. LEAD AND GROUND PADDLE PLATING:
30-80 MICROINCHES GOLD OVER 50 MICROINCHES MINIMUM NICKEL.
3. DIMENSIONS ARE IN INCHES (MILLIMETERS).
4. LEAD SPACING TOLERANCE IS NON-CUMULATIVE.
5. CHARACTERS TO BE HELVETICA MEDIUM, .025 HIGH, BLACK INK, OR LASER MARK LOCATED APPROX. AS SHOWN.
6. PACKAGE WARP SHALL NOT EXCEED 0.05MM DATUM $-C-$
7. ALL GROUND LEADS AND GROUND PADDLE MUST BE SOLDERED TO PCB RF GROUND.

Package Information

Part Number	Package Body Material	Lead Finish	MSL Rating	Package Marking ^[2]
HMC553LC3B	Alumina, White	Gold over Nickel	MSL3 ^[1]	H553 XXXX

[1] Max peak reflow temperature of 260 °C

[2] 4-Digit lot number XXXX

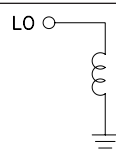
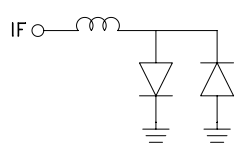
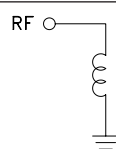

Pin Descriptions

Pin Number	Function	Description	Interface Schematic
1, 3, 4, 6, 7, 9	GND	Package bottom must also be connected to RF/DC ground.	
2	LO	This pin is DC coupled and matched to 50 Ohms.	
5	IF	This pin is DC coupled. For applications not requiring operation to DC, this port should be DC blocked externally using a series capacitor whose value has been chosen to pass the necessary IF frequency range. For operation to DC, this pin must not source or sink more than 2 mA of current or part non-function and possible part failure will result.	
8	RF	This pin is DC coupled and matched to 50 Ohms.	
10, 11, 12	N/C	No connection required. These pins may be connected to RF/DC ground without affecting performance.	



**GaAs MMIC FUNDAMENTAL
MIXER, 7 - 14 GHz**

Evaluation PCB

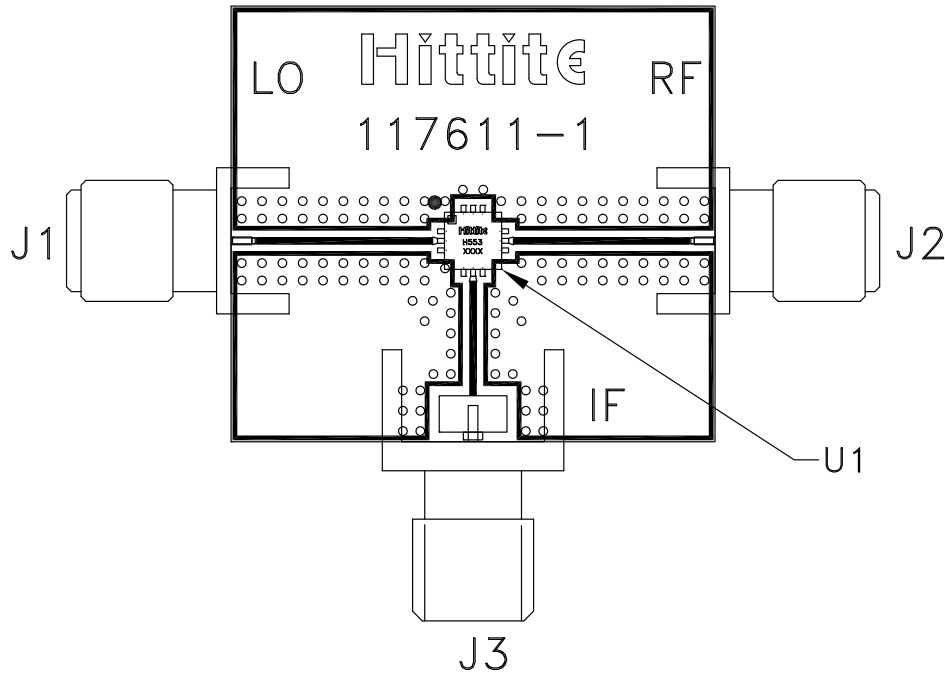

List of Materials for Evaluation PCB 109952 [1]

Item	Description
J1 - J2	SRI SMA Connector
J3	Johnson SMA Connector
U1	HMC553LC3B Mixer
PCB [2]	117611 Evaluation PCB

[1] Reference this number when ordering complete evaluation PCB



[2] Circuit Board Material: Arlon 25 FR

The circuit board used in this application should use RF circuit design techniques. Signal lines should have 50 Ohm impedance while the package ground leads and exposed paddle should be connected directly to the ground plane similar to that shown. A sufficient number of via holes should be used to connect the top and bottom ground planes. The evaluation circuit board shown is available from Hittite upon request.

**GaAs MMIC FUNDAMENTAL
MIXER, 7 - 14 GHz**

Looking for pricing, stock, or lifecycle information?

Click below to explore more details on WIN SOURCE:

-  [View HMC553 on WIN SOURCE](#)
-  [Analog Devices Inc. Information](#)

Optimize Your Supply Chain with WIN SOURCE Solutions

-  Global Sourcing Solution
-  Obsolete Management
-  Cost Control Management
-  Shortage Management
-  Alternative Solution
-  Excess Inventory Management