



**THE DATASHEET OF  
APX809-29SAG-7**



## Description

The APX809/810 are used for microprocessor ( $\mu\text{P}$ ) supervisory circuits to monitor the power supplies in  $\mu\text{P}$  and digital systems. They provide excellent circuit reliability and low cost by eliminating external components and adjustments when used with 5V, 3.3V, 3.0V powered circuits.

These circuits perform a single function: they assert a reset signal whenever the  $V_{\text{CC}}$  supply voltage declines below a preset threshold, keeping it asserted for at least 240ms after  $V_{\text{CC}}$  has risen above the reset threshold. Reset thresholds suitable for operation with a variety of supply voltages are available. The APX809/810 have push pull outputs. The APX809 have an active low  $\overline{\text{RESET}}$  output, while the APX810 has an active high RESET output. The reset comparator is designed to ignore fast transients on  $V_{\text{CC}}$ , and the outputs are guaranteed to be in the correct logic state for  $V_{\text{CC}}$  down to 1V. Low supply current makes the APX809/810 ideal for use in portable equipment. The APX809/810 is available in a 3-pin SOT23 package.

## Features

- Precision Monitoring of 2.5V, 3V, 3.3V, and 5V Power-Supply Voltages
- Fully Specified Over Temperature
- Available in Three Output Configurations
- Push-Pull  $\overline{\text{RESET}}$  Active Low (APX809)
- Push-Pull RESET Active High (APX810)
- 200ms Typ Power-On Reset Pulse Width
- 30 $\mu\text{A}$  Supply Current (Typ.)
- Guaranteed Reset Valid to  $V_{\text{CC}} = 1\text{V}$
- No External Components
- SOT23: Available in "Green" Molding Compound (No Br, Sb)
- **Totally Lead-Free & Fully RoHS Compliant (Notes 1 & 2)**
- **Halogen and Antimony Free. "Green" Device (Note 3)**

- Notes:
1. No purposely added lead. Fully EU Directive 2002/95/EC (RoHS) & 2011/65/EU (RoHS 2) compliant.
  2. See [http://www.diodes.com/quality/lead\\_free.html](http://www.diodes.com/quality/lead_free.html) for more information about Diodes Incorporated's definitions of Halogen- and Antimony-free, "Green" and Lead-free.
  3. Halogen- and Antimony-free "Green" products are defined as those which contain <900ppm bromine, <900ppm chlorine (<1500ppm total Br + Cl) and <1000ppm antimony compounds.

## Typical Applications Circuit



## Pin Assignments

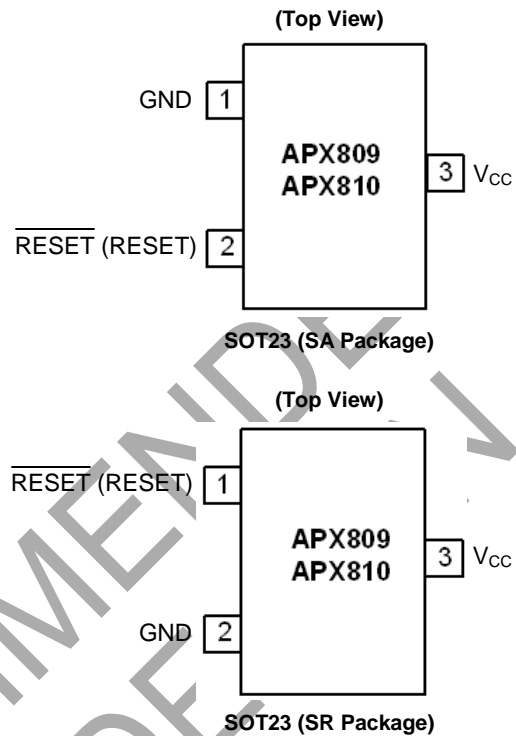

## Applications

- Computers
- Controllers
- Intelligent Instruments
- Critical  $\mu\text{P}$  and  $\mu\text{C}$  Power Monitoring
- Portable/Battery Powered Equipment

## Pin Descriptions

Pin Name	Description
GND	Ground
$\overline{\text{RESET}}$ (RESET)	Reset Output Pin L: for APX809 H: for APX810
V <sub>CC</sub>	Operating Voltage Input

## Functional Block Diagram



## Absolute Maximum Ratings

Symbol	Parameter	Rating	Unit
ESD HBM	Human Body Model ESD Protection	5	kV
ESD MM	Machine Model ESD Protection	500	V
V <sub>CC</sub>	Supply Voltage	-0.3 to +6.0	V
V <sub>RESET</sub>	RESET, $\overline{\text{RESET}}$ (Push-pull)	-0.3 to (V <sub>CC</sub> + 0.3)	V
I <sub>CC</sub>	Input Current, V <sub>CC</sub>	20	mA
I <sub>O</sub>	Output Current, RESET, $\overline{\text{RESET}}$	20	mA
P <sub>D</sub>	Continuous Power Dissipation (T <sub>A</sub> = +70°C), De-rate 4mW/°C above +70°C	400	mW
T <sub>OP</sub>	Operating Junction Temperature Range	-40 to +105	°C
T <sub>ST</sub>	Storage Temperature Range	-65 to +150	°C

## Recommended Operating Conditions

Symbol	Parameter	Min	Max	Unit
V <sub>CC</sub>	Supply Voltage	1.1	5.5	V
V <sub>IN</sub>	Input Voltage	0	(V <sub>CC</sub> + 0.3)	V
T <sub>A</sub>	Operating Ambient Temperature Range	-40	+85	°C
t <sub>R</sub>	V <sub>CC</sub> Rising Time (V <sub>CC</sub> = 0 to V <sub>T</sub> )	—	100	µs

## Electrical Characteristics (@T<sub>A</sub> = -40 to +85°C, unless otherwise note. Typical values are at T<sub>A</sub> = +25°C.)

Symbol	Parameter	Test Conditions	Min	Typ	Max	Unit	
V <sub>CC</sub>	V <sub>CC</sub> Range	T <sub>A</sub> = 0°C to +70°C	1.0	—	5.5	V	
I <sub>CC</sub>	Supply Current	V <sub>TH</sub> + 0.2V	—	30	40	µA	
V <sub>TH</sub>	Reset Threshold	T <sub>A</sub> = 0°C to +85°C	APX809/810-23	2.21	2.25	2.30	V
			APX809/810-26	2.59	2.63	2.69	
			APX809/810-29	2.88	2.93	3.00	
			APX809/810-31	3.02	3.08	3.15	
			APX809/810-40	3.93	4.00	4.08	
			APX809/810-44	4.31	4.38	4.47	
			APX809/810-46	4.56	4.63	4.72	
		T <sub>A</sub> = -40°C to +85°C	APX809/810-23	2.20	2.25	2.30	V
			APX809/810-26	2.57	2.63	2.69	
			APX809/810-29	2.86	2.93	3.00	
			APX809/810-31	3.00	3.08	3.15	
			APX809/810-40	3.92	4.00	4.08	
			APX809/810-44	4.29	4.38	4.47	
			APX809/810-46	4.54	4.63	4.72	
	Reset Threshold Tempco	—	—	30	—	ppm/°C	
t <sub>S</sub>	Set-up Time	V <sub>CC</sub> = V <sub>TH</sub> to (V <sub>TH</sub> - 100mV)	—	20	—	µs	
t <sub>DELAY</sub>	Reset Active Timeout Period	T <sub>A</sub> = 0°C to +85°C	140	200	280	ms	
V <sub>OL</sub>	RESET Output Voltage Low (APX809)	V <sub>CC</sub> = V <sub>TH</sub> - 0.2, I <sub>SINK</sub> = 1.2mA	—	—	0.3	V	
		V <sub>CC</sub> = V <sub>TH</sub> - 0.2, I <sub>SINK</sub> = 3.2mA	—	—	0.4		
		V <sub>CC</sub> > 1.0V, I <sub>SINK</sub> = 50µA	—	—	0.3		
V <sub>OH</sub>	RESET Output Voltage-High (APX809)	V <sub>CC</sub> > V <sub>TH</sub> + 0.2, I <sub>SOURCE</sub> = 500µA	0.8V <sub>CC</sub>	—	—	V	
		V <sub>CC</sub> > V <sub>TH</sub> + 0.2, I <sub>SOURCE</sub> = 800µA	V <sub>CC</sub> - 1.5	—	—		
V <sub>OL</sub>	RESET Output Voltage-Low (APX810)	V <sub>CC</sub> = V <sub>TH</sub> + 0.2, I <sub>SINK</sub> = 1.2mA	—	—	0.3	V	
		V <sub>CC</sub> = V <sub>TH</sub> + 0.2, I <sub>SINK</sub> = 3.2mA	—	—	0.4		
V <sub>OH</sub>	RESET Output Voltage-High (APX810)	1.8V < V <sub>CC</sub> < V <sub>TH</sub> - 0.2, I <sub>SOURCE</sub> = 150µA	0.8V <sub>CC</sub>	—	—	V	
θ <sub>JA</sub>	Thermal Resistance Junction-to-Ambient	SOT23 (Note 4)	—	201	—	°C/W	
θ <sub>JC</sub>	Thermal Resistance Junction-to-Case	SOT23 (Note 4)	—	56	—	°C/W	

Note: 4. Test condition for SOT23: Devices mounted on FR-4 substrate PC board, 2oz copper, with minimum recommended pad layout.

**Performance Characteristics**

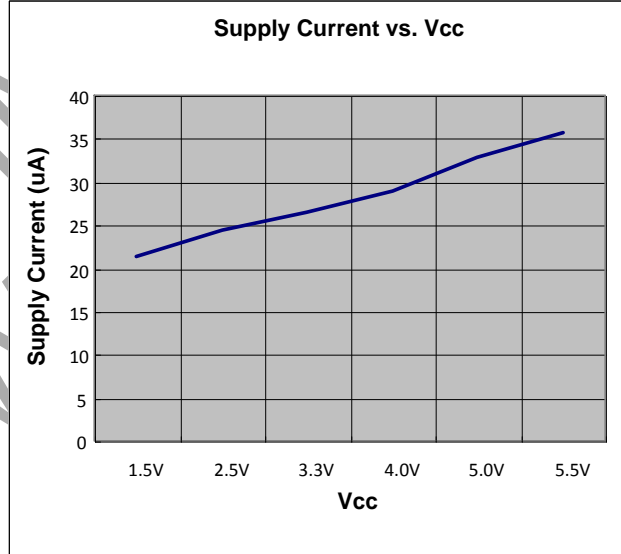
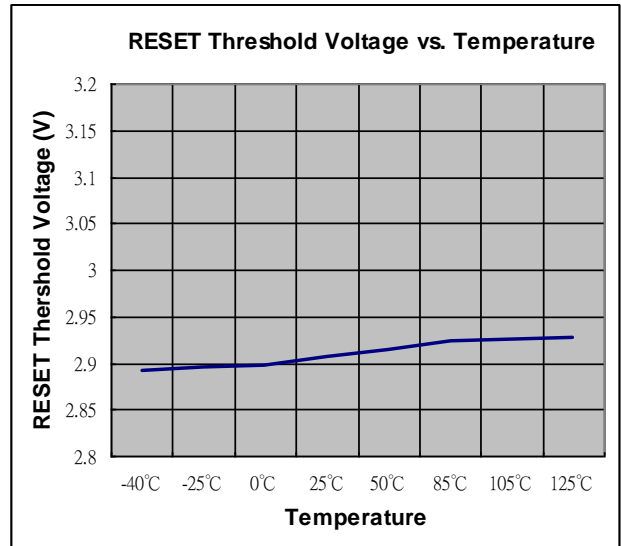

**Timing Diagram**



## Functional Description

A microprocessor's ( $\mu P$ 's) reset input starts the  $\mu P$  in a known state. The APX809/810 assert reset to prevent code-execution errors during power-up, power-down, or brownout conditions. They assert a reset signal whenever the  $V_{CC}$  supply voltage declines below a preset threshold, keeping it asserted for at least 240ms after  $V_{CC}$  has risen above the reset threshold. The APX809/810 have a push-pull output stage.

### Ensuring a Valid Reset Output

#### Down to $V_{CC} = 0$

$\overline{RESET}$  is guaranteed to be a logic low for  $V_{CC} > 1V$ . Once  $V_{CC}$  exceeds the reset threshold, an internal timer keeps  $\overline{RESET}$  low for the reset timeout period; after this interval,  $\overline{RESET}$  goes high. If a brownout condition occurs ( $V_{CC}$  dips below the  $\overline{RESET}$  reset threshold),  $\overline{RESET}$  goes low. Any time  $V_{CC}$  goes below the reset threshold, the internal timer resets to zero, and  $\overline{RESET}$  goes low. The internal timer starts after  $V_{CC}$  returns above the reset threshold, and  $\overline{RESET}$  remains low for the reset timeout period.

When  $V_{CC}$  falls below 1V, the APX809  $\overline{RESET}$  output no longer sinks current — it becomes an open circuit. Therefore, high-impedance CMOS logic inputs connected to  $\overline{RESET}$  can drift to undetermined voltages.

This presents no problem in most applications since most  $\mu P$  and other circuitry is inoperative with  $V_{CC}$  below 1V. However, in applications where  $\overline{RESET}$  must be valid down to 0V, adding a pull down resistor to  $\overline{RESET}$  causes any stray leakage currents to flow to ground, holding  $\overline{RESET}$  low. R1's value is not critical; 100k are large enough not to load  $\overline{RESET}$  and small enough to pull  $\overline{RESET}$  to ground. For the APX810 if  $\overline{RESET}$  is required to remain valid for  $V_{CC} < 1V$ .

### Benefits of Highly Accurate Reset Threshold

Most  $\mu P$  supervisor ICs has reset threshold voltages between 5% and 10% below the value of nominal supply voltages. This ensures a reset will not occur within 5% of the nominal supply, but will occur when the supply is 10% below nominal. When using ICs rated at only the nominal supply  $\pm 5\%$ , this leaves a zone of uncertainty where the supply is between 5% and 10% low, and where the reset may or may not be asserted.

## Ordering Information



Part Number	Package Code	Packaging (Note 5)	7" Tape and Reel	
			Quantity	Part Number Suffix
APX809-XXSAG-7	SA	SOT23	3000/Tape & Reel	-7
APX810-XXSAG-7	SA	SOT23	3000/Tape & Reel	-7
APX809-XXSRG-7	SR	SOT23	3000/Tape & Reel	-7
APX810-XXSRG-7	SR	SOT23	3000/Tape & Reel	-7

Note: 5. Pad layout as shown in Diodes Incorporated's package outline PDFs, which can be found on our website at <http://www.diodes.com/package-outlines.html>.

## Marking Information

(1) SOT23

( Top View )



XX : Identification code

Y : Year 0~9

W : Week : A~Z : 1~26 week;  
a~z : 27~52 week; z represents  
52 and 53 week

X : A~Z : Green

Device	Package	Identification Code
APX809-46SA	SOT23	X2
APX809-44SA	SOT23	X3
APX809-40SA	SOT23	X4
APX809-31SA	SOT23	X5
APX809-29SA	SOT23	X6
APX809-26SA	SOT23	X7
APX809-23SA	SOT23	X8
APX810-46SA	SOT23	XA
APX810-44SA	SOT23	XB
APX810-40SA	SOT23	XC
APX810-31SA	SOT23	XD
APX810-29SA	SOT23	XE
APX810-26SA	SOT23	XF
APX810-23SA	SOT23	XG
APX809-46SR	SOT23	Y2
APX809-44SR	SOT23	Y3
APX809-40SR	SOT23	Y4
APX809-31SR	SOT23	Y5
APX809-29SR	SOT23	Y6
APX809-26SR	SOT23	Y7
APX809-23SR	SOT23	Y8
APX810-46SR	SOT23	YA
APX810-44SR	SOT23	YB
APX810-40SR	SOT23	YC
APX810-31SR	SOT23	YD
APX810-29SR	SOT23	YE
APX810-26SR	SOT23	YF
APX810-23SR	SOT23	YG

**Package Outline Dimensions**

Please see <http://www.diodes.com/package-outlines.html> for the latest version.

**SOT23**

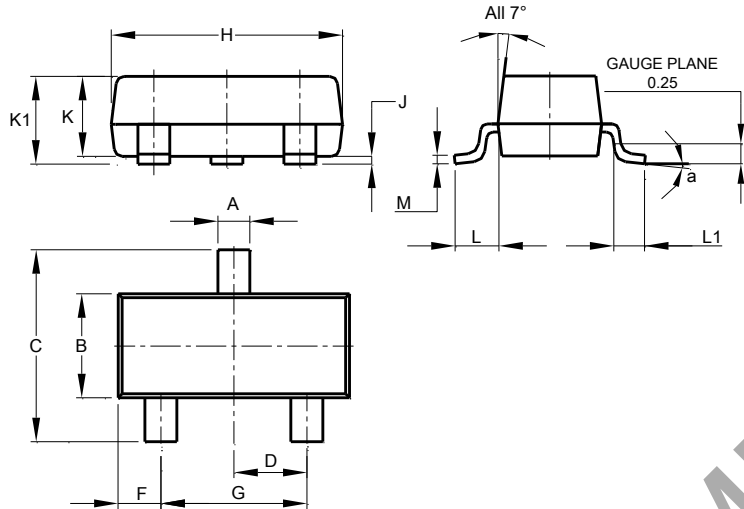

SOT23			
Dim	Min	Max	Typ
A	0.37	0.51	0.40
B	1.20	1.40	1.30
C	2.30	2.50	2.40
D	0.89	1.03	0.915
F	0.45	0.60	0.535
G	1.78	2.05	1.83
H	2.80	3.00	2.90
J	0.013	0.10	0.05
K	0.890	1.00	0.975
K1	0.903	1.10	1.025
L	0.45	0.61	0.55
L1	0.25	0.55	0.40
M	0.085	0.150	0.110
a	0°	8°	--
All Dimensions in mm			

**Suggested Pad Layout**

Please see <http://www.diodes.com/package-outlines.html> for the latest version.

**SOT23**

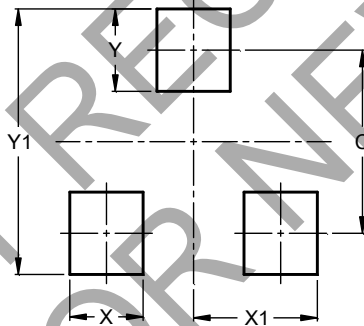

Dimensions	Value (in mm)
C	2.0
X	0.8
X1	1.35
Y	0.9
Y1	2.9

**IMPORTANT NOTICE**

DIODES INCORPORATED MAKES NO WARRANTY OF ANY KIND, EXPRESS OR IMPLIED, WITH REGARDS TO THIS DOCUMENT, INCLUDING, BUT NOT LIMITED TO, THE IMPLIED WARRANTIES OF MERCHANTABILITY AND FITNESS FOR A PARTICULAR PURPOSE (AND THEIR EQUIVALENTS UNDER THE LAWS OF ANY JURISDICTION).

Diodes Incorporated and its subsidiaries reserve the right to make modifications, enhancements, improvements, corrections or other changes without further notice to this document and any product described herein. Diodes Incorporated does not assume any liability arising out of the application or use of this document or any product described herein; neither does Diodes Incorporated convey any license under its patent or trademark rights, nor the rights of others. Any Customer or user of this document or products described herein in such applications shall assume all risks of such use and will agree to hold Diodes Incorporated and all the companies whose products are represented on Diodes Incorporated website, harmless against all damages.

Diodes Incorporated does not warrant or accept any liability whatsoever in respect of any products purchased through unauthorized sales channel. Should Customers purchase or use Diodes Incorporated products for any unintended or unauthorized application, Customers shall indemnify and hold Diodes Incorporated and its representatives harmless against all claims, damages, expenses, and attorney fees arising out of, directly or indirectly, any claim of personal injury or death associated with such unintended or unauthorized application.

Products described herein may be covered by one or more United States, international or foreign patents pending. Product names and markings noted herein may also be covered by one or more United States, international or foreign trademarks.

This document is written in English but may be translated into multiple languages for reference. Only the English version of this document is the final and determinative format released by Diodes Incorporated.

**LIFE SUPPORT**

Diodes Incorporated products are specifically not authorized for use as critical components in life support devices or systems without the express written approval of the Chief Executive Officer of Diodes Incorporated. As used herein:

A. Life support devices or systems are devices or systems which:

1. are intended to implant into the body, or
2. support or sustain life and whose failure to perform when properly used in accordance with instructions for use provided in the labeling can be reasonably expected to result in significant injury to the user.

B. A critical component is any component in a life support device or system whose failure to perform can be reasonably expected to cause the failure of the life support device or to affect its safety or effectiveness.

Customers represent that they have all necessary expertise in the safety and regulatory ramifications of their life support devices or systems, and acknowledge and agree that they are solely responsible for all legal, regulatory and safety-related requirements concerning their products and any use of Diodes Incorporated products in such safety-critical, life support devices or systems, notwithstanding any devices- or systems-related information or support that may be provided by Diodes Incorporated. Further, Customers must fully indemnify Diodes Incorporated and its representatives against any damages arising out of the use of Diodes Incorporated products in such safety-critical, life support devices or systems.

Copyright © 2017, Diodes Incorporated

[www.diodes.com](http://www.diodes.com)

## Looking for pricing, stock, or lifecycle information?

Click below to explore more details on WIN SOURCE:

- ⊖ [View APX809-29SAG-7 on WIN SOURCE](#)
- ⊖ [Diodes Incorporated Information](#)

## Optimize Your Supply Chain with WIN SOURCE Solutions

- ✓ Global Sourcing Solution
- ✓ Obsolete Management
- ✓ Cost Control Management
- ✓ Shortage Management
- ✓ Alternative Solution
- ✓ Excess Inventory Management