



**THE DATASHEET OF
APX803-31SAG-7**



Description

The APX803/D is used for microprocessor (μ P) supervisory circuits to monitor the power supplies in μ P and digital systems. They provide excellent circuit reliability and low cost by eliminating external components and adjustments when used with 5V, 3.3V, 3.0V powered circuits.

These circuits perform a single function: they assert a reset signal on power up and whenever the V_{CC} supply voltage declines below a preset threshold, keeping it asserted for a fixed period of time after V_{CC} has risen above the reset threshold. For the APX803D this period is a minimum of 1ms while for other APX803 variants it is at least 140ms. The reset comparator is designed to ignore fast transients on V_{CC} , and the outputs are guaranteed to be in the correct logic state for V_{CC} down to 1V.

The APX803 is available with different reset thresholds suitable for operation with a variety of supply voltages, however the APX803D is available with a 2.93V threshold voltage.

The APX803/D have an open collector active low $\overline{\text{RESET}}$ output and compliment Diodes APX809/10 which have push-pull output stages. Low supply current makes the APX803/D ideal for use in portable equipment. The APX803/D are available in two pin out variants of the 3-pin SOT23 package.

Features

- Precision Monitoring of 2.5V, 3V, 3.3V, and 5V Power-Supply Voltages
- Fully Specified Over Temperature
- Open-drain $\overline{\text{RESET}}$ Active Low
- Power-On/Power Supply Glitch Reset Pulse
 - APX803D 2ms (Typ)
 - APX803 200ms (Typ)
- 30 μ A Supply Current (Typ.)
- Guaranteed Reset Valid to $V_{CC} = 1V$
- No External Components
- SOT23: Available in "Green" Molding Compound (No Br, Sb)
- **Totally Lead-Free & Fully RoHS Compliant (Notes 1 & 2)**
- **Halogen and Antimony Free. "Green" Device (Note 3)**

- Notes:
1. No purposely added lead. Fully EU Directive 2002/95/EC (RoHS) & 2011/65/EU (RoHS 2) compliant.
 2. See http://www.diodes.com/quality/lead_free.html for more information about Diodes Incorporated's definitions of Halogen- and Antimony-free, "Green" and Lead-free.
 3. Halogen- and Antimony-free "Green" products are defined as those which contain <900ppm bromine, <900ppm chlorine (<1500ppm total Br + Cl) and <1000ppm antimony compounds.

Pin Assignments

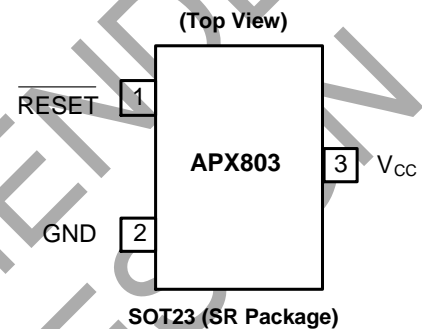
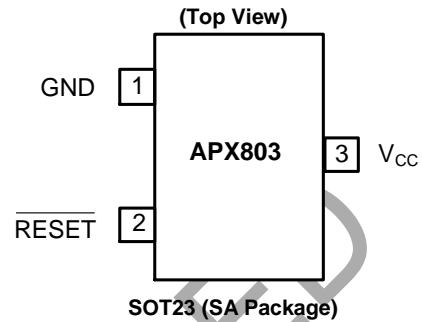

Applications

- Computers
- Controllers
- Intelligent Instruments
- Critical μ P and μ C Power Monitoring
- Portable/Battery Powered Equipment

Typical Applications Circuit

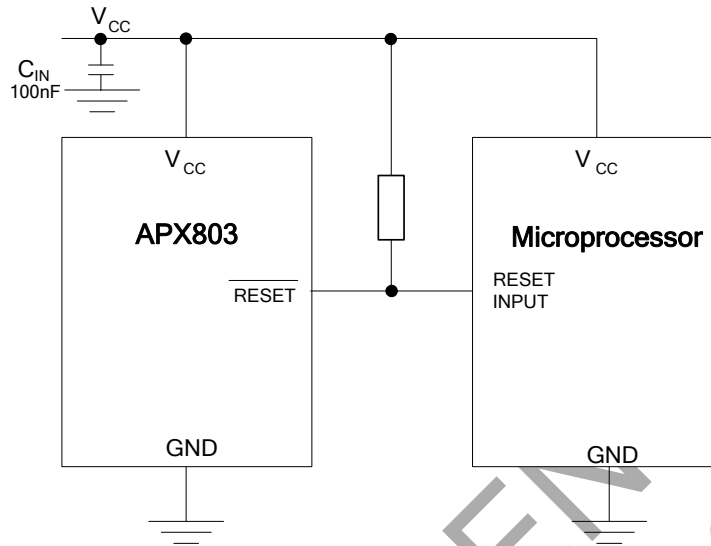

Pin Descriptions

Pin Name	Description
GND	Ground
$\overline{\text{RESET}}$	Reset Output Pin Active Low Open Drain
V _{CC}	Operating Voltage Input

Functional Block Diagram

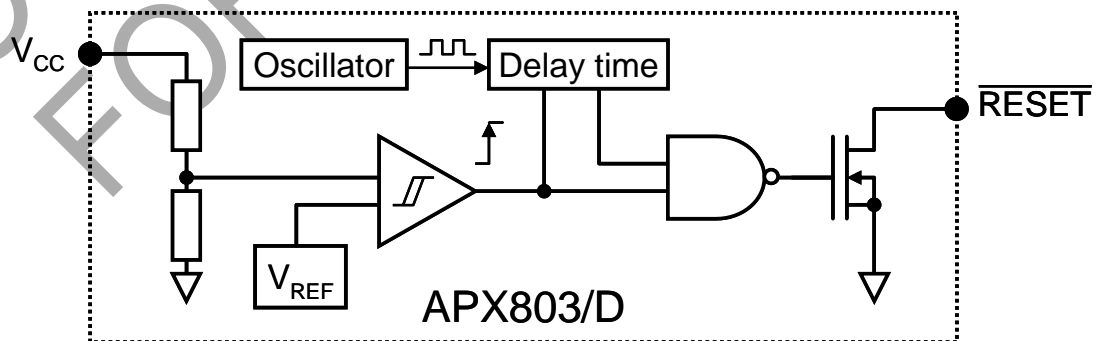

Absolute Maximum Ratings

Symbol	Parameter	Rating	Unit
ESD HBM	Human Body Model ESD Protection	2	kV
ESD MM	Machine Model ESD Protection	200	V
V _{CC}	Supply Voltage	-0.3 to +6.0	V
V _{RESET}	$\overline{\text{RESET}}$ (Open Drain)	-0.3 to 6	V
I _{CC}	Input Current, V _{CC}	20	mA
I _O	Output Current, $\overline{\text{RESET}}$	20	mA
P _D	Continuous Power Dissipation (T _A = +70°C), De-rate 4mW/°C above +70°C	400	mW
T _{OP}	Operating Junction Temperature Range	-40 to +105	°C
T _{ST}	Storage Temperature Range	-65 to +150	°C

Recommended Operating Conditions

Symbol	Parameter	Min	Max	Unit
V _{CC}	Supply Voltage	1.1	5.5	V
V _{IN}	Input Voltage	0	(V _{CC} + 0.3)	V
V _{RESET}	$\overline{\text{RESET}}$ Output Voltage	0	5.5	V
T _A	Operating Ambient Temperature Range	-40	+85	°C
dV _{CC} /dt	V _{CC} Rate of Rise (V _{CC} = 0 to V _T)	—	100	V/μs

NOT RECOMMENDED FOR NEW DESIGN

Electrical Characteristics (@ $T_A = -40$ to $+85^\circ\text{C}$, unless otherwise note. Typical values are at $T_A = +25^\circ\text{C}$.)

Symbol	Parameter	Test Conditions	Min	Typ	Max	Unit	
I_{CC}	Supply Current	$V_{TH} + 0.2V$	—	30	40	μA	
V_{TH}	Reset Threshold	$T_A = +25^\circ\text{C}$	APX803-23	2.21	2.25	2.30	V
			APX803-26	2.59	2.63	2.66	
			APX803-29	2.89	2.93	2.96	
			APX803D-29	2.89	2.93	2.96	
			APX803-31	3.04	3.08	3.13	
			APX803-40	3.94	4.00	4.06	
			APX803-44	4.31	4.38	4.45	
			APX803-46	4.56	4.63	4.70	
	Reset Threshold Hysteresis	$V_{TH-H} - V_{TH-L}$	—	40	—	mV	
	Reset Threshold Tempco	—	—	30	—	ppm/ $^\circ\text{C}$	
t_s	V_{CC} to RESET Delay	$V_{CC} = V_{TH}$ to $(V_{TH} - 100\text{mV})$	—	20	—	μs	
t_{DELAY}	Reset Active Timeout Period	$T_A = 0^\circ\text{C}$ to $+85^\circ\text{C}$	APX803-XX	140	200	280	ms
			APX803D-29	1	—	3.3	
V_{OL}	RESE T Output Voltage Low	$V_{CC} = V_{TH} - 0.2, I_{SINK} = 1.2\text{mA}$	—	—	0.3	V	
		$V_{CC} = V_{TH} - 0.2, I_{SINK} = 3.5\text{mA}$	—	—	0.4		
		$V_{CC} > 1.0V, I_{SINK} = 50\mu\text{A}$	—	—	0.3		
I_{OH}	RESE T Output High Leakage Current	$V_{CC} > V_{TH} + 0.2$	—	—	1	μA	
θ_{JA}	Thermal Resistance Junction-to-Ambient	SOT23 (Note 4)	—	201	—	$^\circ\text{C/W}$	
θ_{JC}	Thermal Resistance Junction-to-Case	SOT23 (Note 4)	—	56	—	$^\circ\text{C/W}$	

Notes: 4. Test condition for SOT23: Devices mounted on FR-4 substrate PC board, 2oz copper, with minimum recommended pad layout.
5. Final datasheet limits to be determined by characterization and correlation.

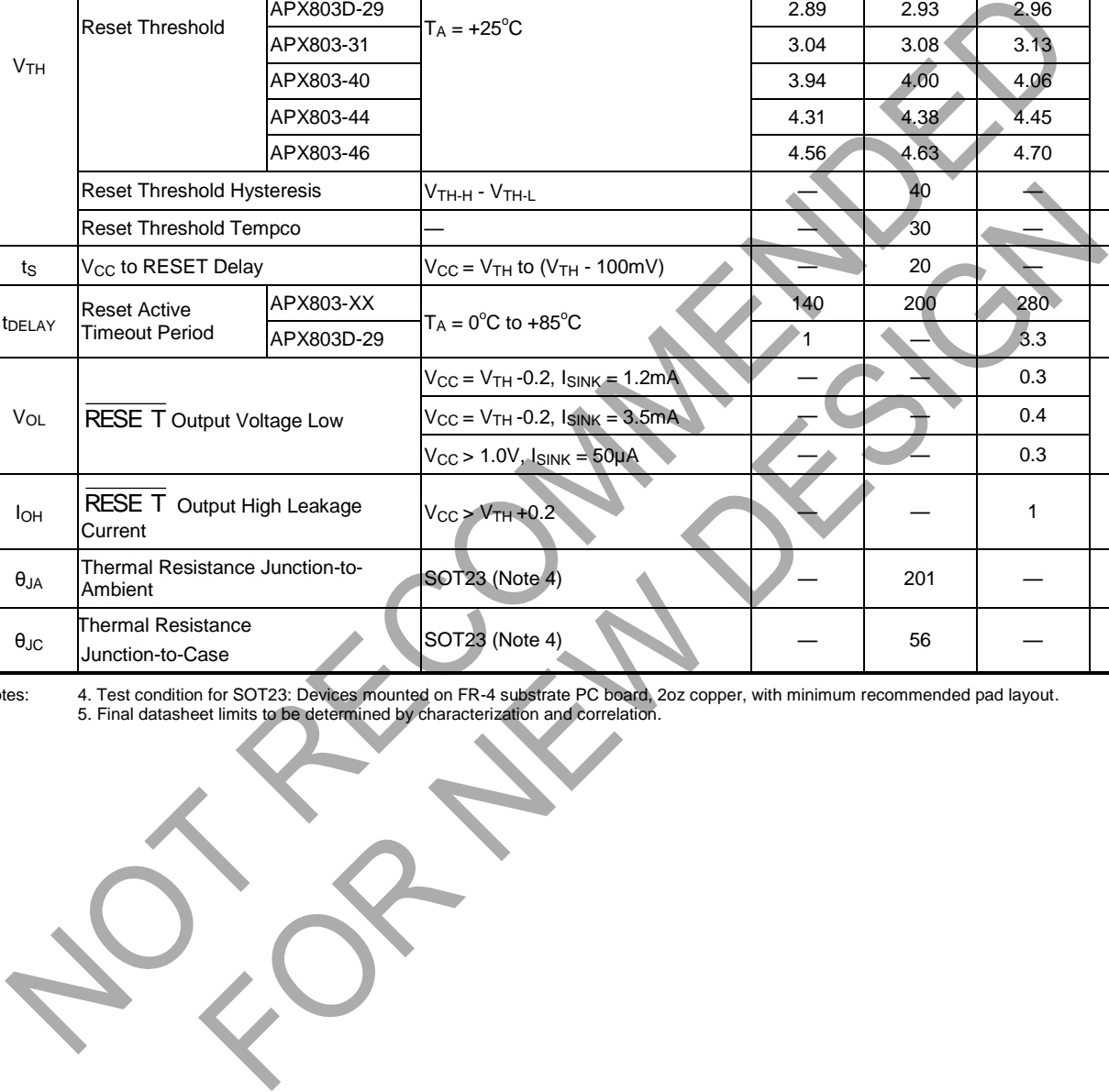

Performance Characteristics

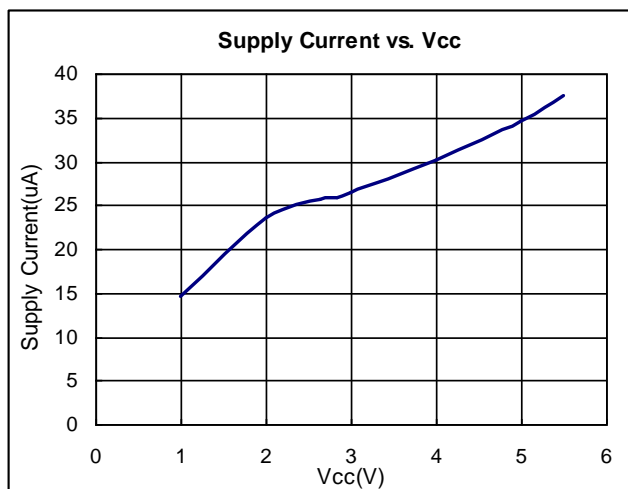
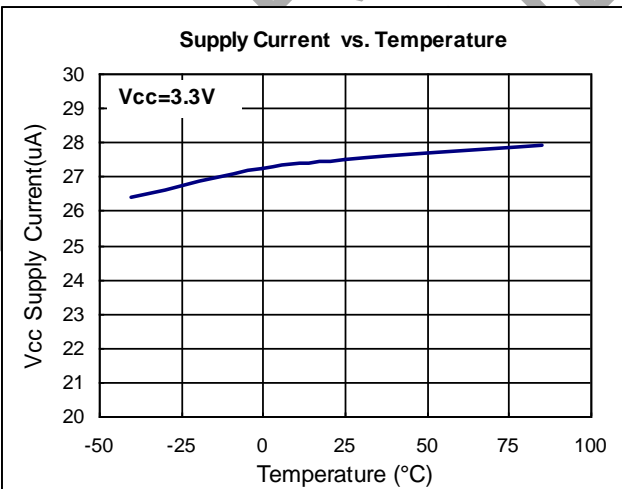
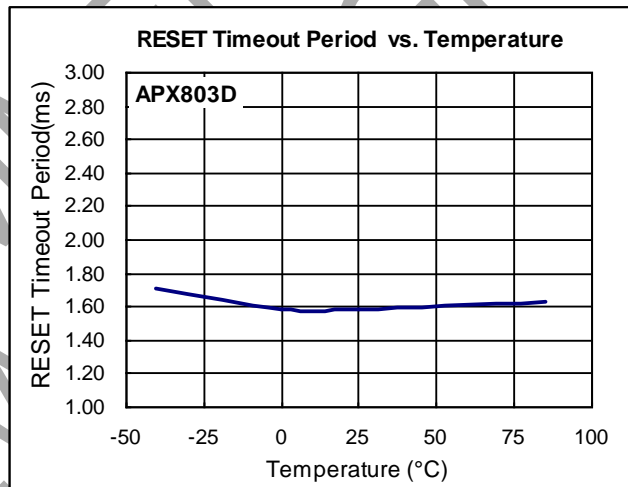
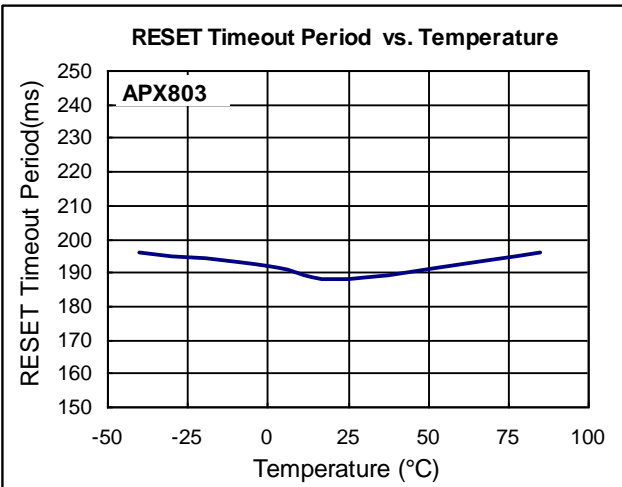
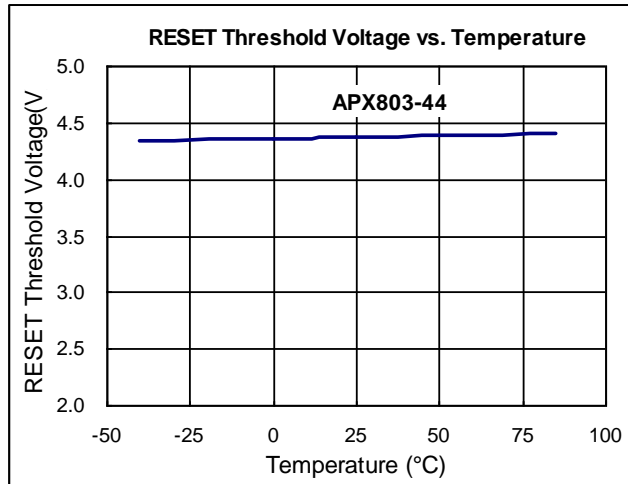
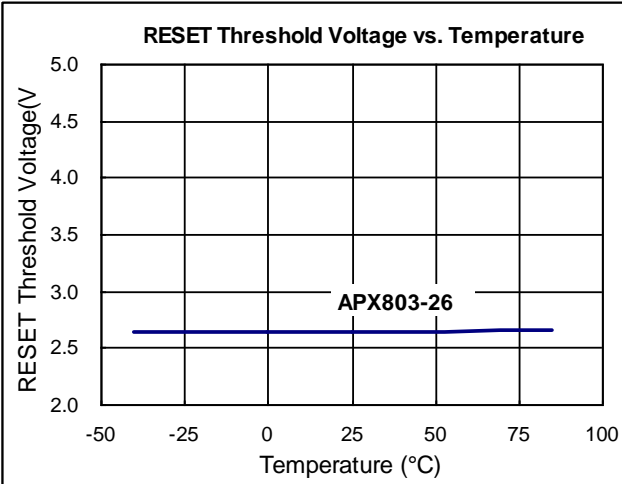

Performance Characteristics (Cont.)

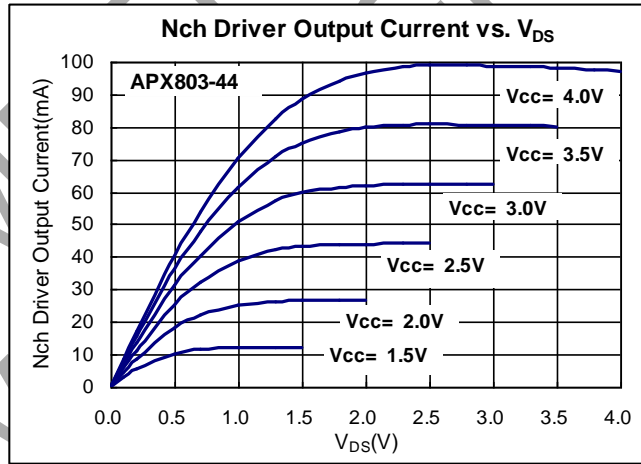
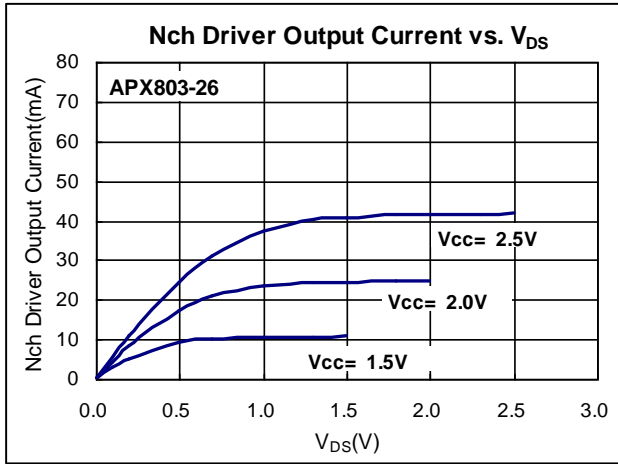
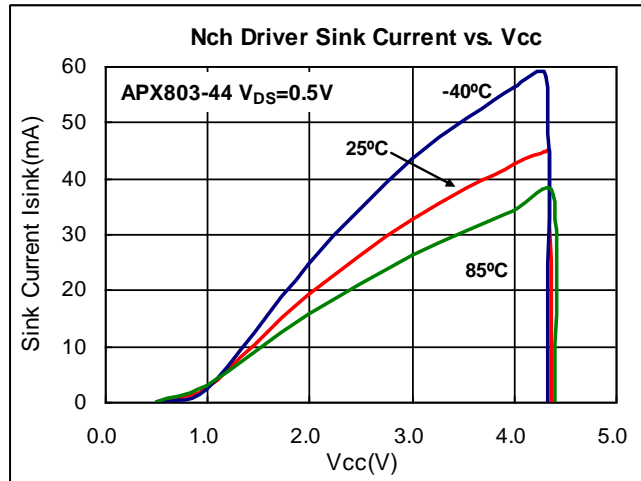
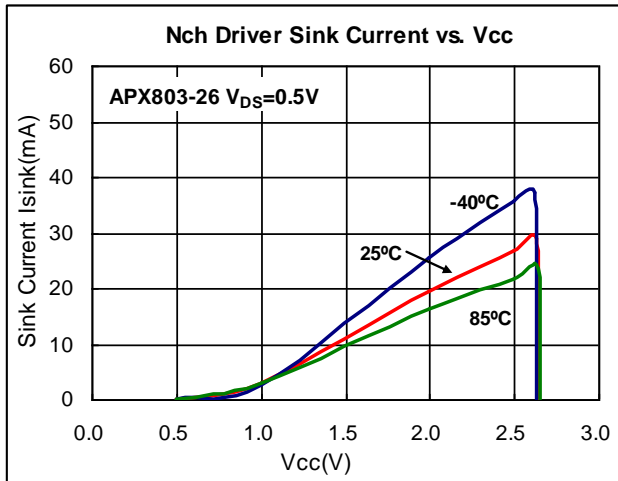

Timing Diagram

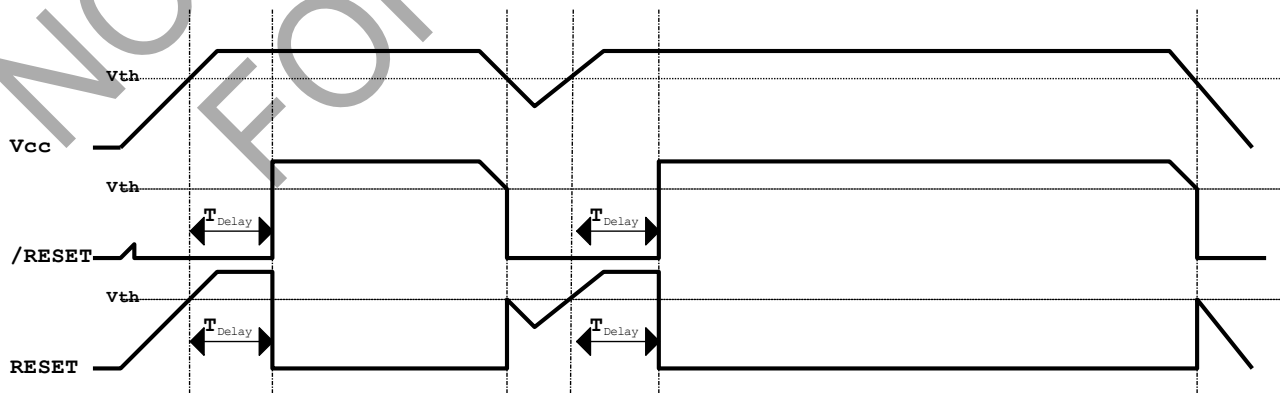

Functional Description

Microprocessors (μ Ps) and microcontrollers (μ C) have a reset input to ensure that it starts up in a known state. The APX803/D drive the μ P's reset input to prevent code-execution errors during power-up, power-down, or brownout conditions. They assert a reset signal whenever the V_{CC} supply voltage declines below a preset threshold and keep it asserted for a fixed period of time after V_{CC} has risen above the reset threshold. For the APX803D this period is a minimum of 1ms while for other APX803 variants it is at least 140ms. The APX803/D have an open-drain output stage.

Ensuring a Valid Reset Output

Down to $V_{CC} = 0$

$\overline{\text{RESET}}$ is guaranteed to be a logic low for $V_{CC} > 1V$. Once V_{CC} exceeds the reset threshold, an internal timer keeps $\overline{\text{RESET}}$ low for the reset timeout period; after this interval, $\overline{\text{RESET}}$ goes high. If a brownout condition occurs (V_{CC} dips below the $\overline{\text{RESET}}$ reset threshold), $\overline{\text{RESET}}$ goes low. Any time V_{CC} goes below the reset threshold, the internal timer resets to zero, and $\overline{\text{RESET}}$ goes low. The internal timer starts after V_{CC} returns above the reset threshold, and $\overline{\text{RESET}}$ remains low for the reset timeout period.

When V_{CC} falls below 1V, the APX803/D $\overline{\text{RESET}}$ output no longer sinks current — it becomes an open circuit. Therefore, high-impedance CMOS logic inputs connected to $\overline{\text{RESET}}$ can drift to undetermined voltages.

This presents no problem in most applications since most μ P and other circuitry is inoperative with V_{CC} below 1V.

Interfacing to μ P with Bidirectional Reset Pins

Since the $\overline{\text{RESET}}$ output on the APX803/D is open drain, this device interfaces easily with μ P/ μ C that have bidirectional reset pins, such as the Motorola 68HC11.

Connecting the μ P supervisor's $\overline{\text{RESET}}$ output directly to the microcontroller's (μ C's) $\overline{\text{RESET}}$ pin with a single pull-up resistor allows either device to assert reset.

Supervising and Monitoring Multiple Supplies

Generally, the pull-up resistor connected to the APX803/D will connect to the supply voltage that is being monitored at the IC's V_{CC} pin. However, some systems may use the APX803/D open-drain output to level-shift from the monitored supply to reset the μ P powered by a different supply voltage or monitor multiple supplies that will be fed into 1 μ C/ μ P reset input.

NOT RECOMMENDED FOR NEW DESIGN

Ordering Information

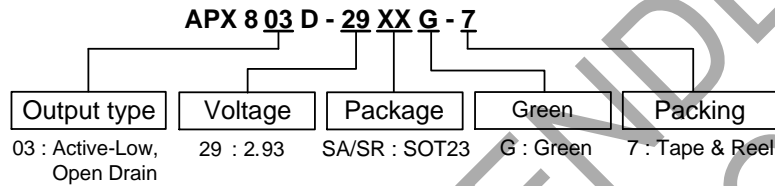
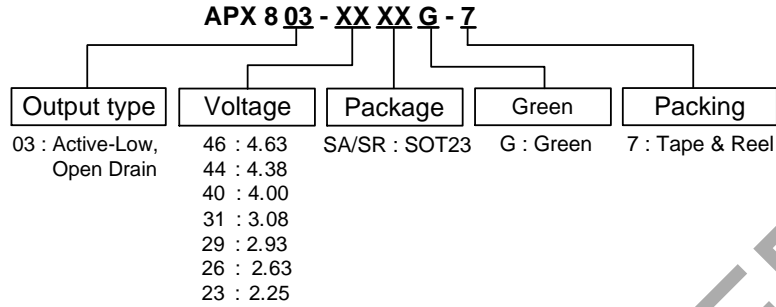

Part Number	Package Code	Packaging (Note 6)	7" Tape and Reel	
			Quantity	Part Number Suffix
APX803-XXSAG-7	SA	SOT23	3000/Tape & Reel	-7
APX803-XXSRG-7	SR	SOT23	3000/Tape & Reel	-7
APX803D-29SAG-7	SA	SOT23	3000/Tape & Reel	-7
APX803D-29SRG-7	SR	SOT23	3000/Tape & Reel	-7

Note: 6. Pad layout as shown in Diodes Incorporated's package outline PDFs, which can be found on our website at <http://www.diodes.com/package-outlines.html>.

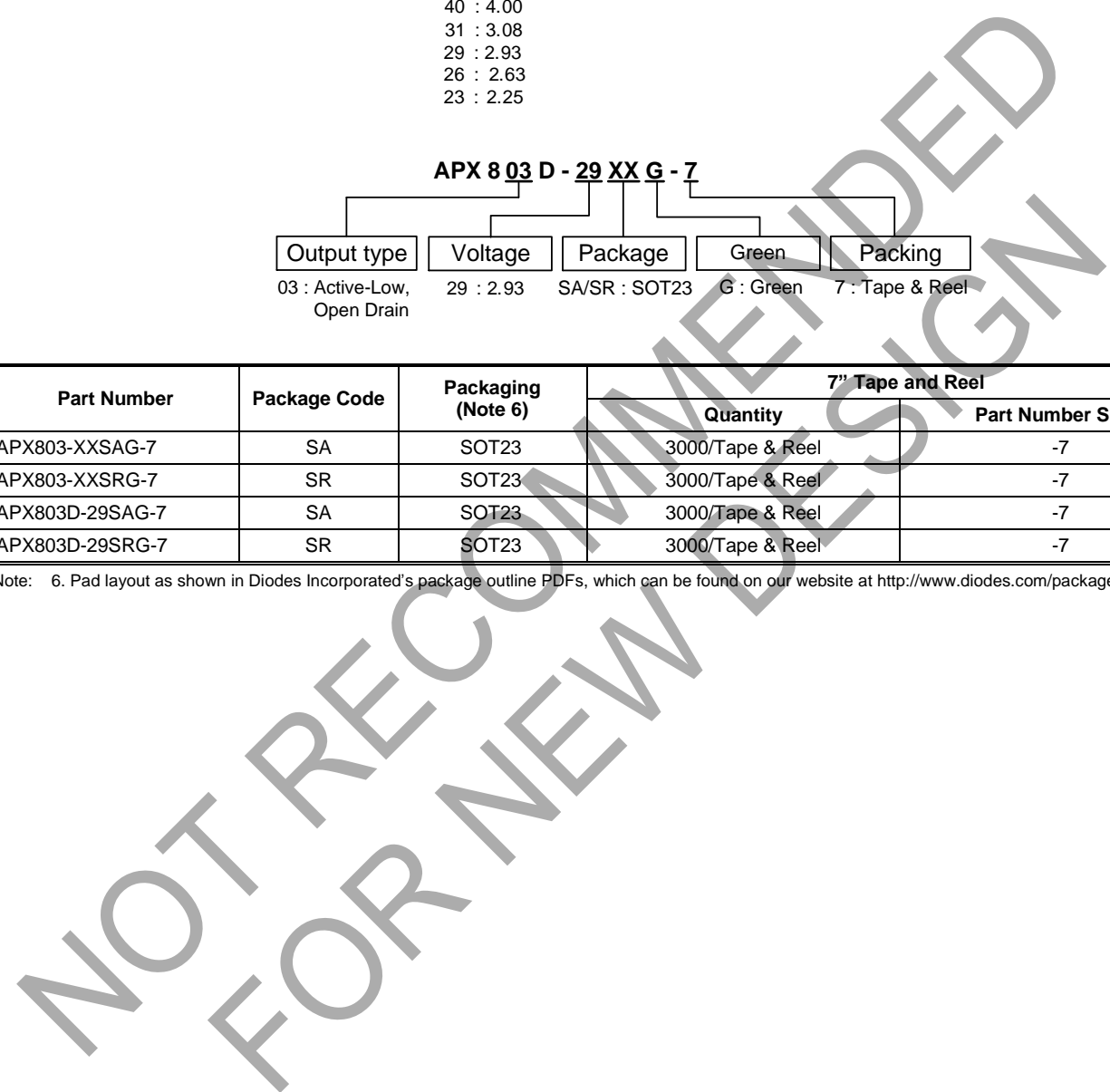

Marking Information

(1) SOT23

(Top View)

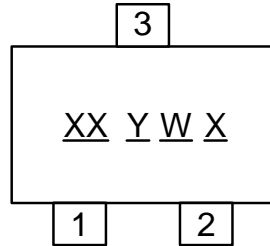

XX : Identification code

Y : Year 0~9

W : Week : A~Z : 1~26 week;
 a~z : 27~52 week; z represents
 52 and 53 week

X : A~Z : Green

Device	Package	Identification Code
APX803-46SA	SOT23	V3
APX803-44SA	SOT23	V4
APX803-40SA	SOT23	V5
APX803-31SA	SOT23	V6
APX803-29SA	SOT23	V7
APX803-26SA	SOT23	V8
APX803-23SA	SOT23	V9
APX803-46SR	SOT23	S3
APX803-44SR	SOT23	S4
APX803-40SR	SOT23	S5
APX803-31SR	SOT23	S6
APX803-29SR	SOT23	S7
APX803-26SR	SOT23	S8
APX803-23SR	SOT23	S9
APX803D-29SA	SOT23	VN
APX803D-29SR	SOT23	SN

NOT RECOMMENDED FOR NEW DESIGN

Package Outline Dimensions

Please see <http://www.diodes.com/package-outlines.html> for the latest version.

SOT23

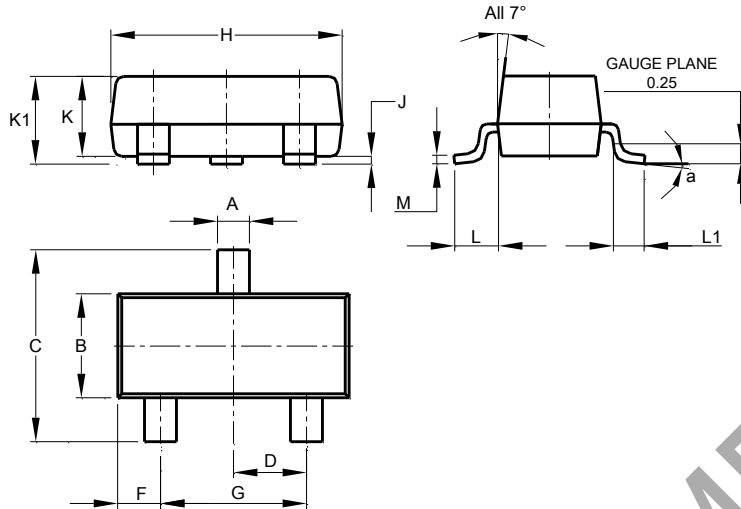

SOT23			
Dim	Min	Max	Typ
A	0.37	0.51	0.40
B	1.20	1.40	1.30
C	2.30	2.50	2.40
D	0.89	1.03	0.915
F	0.45	0.60	0.535
G	1.78	2.05	1.83
H	2.80	3.00	2.90
J	0.013	0.10	0.05
K	0.890	1.00	0.975
K1	0.903	1.10	1.025
L	0.45	0.61	0.55
L1	0.25	0.55	0.40
M	0.085	0.150	0.110
a	0°	8°	--
All Dimensions in mm			

Suggested Pad Layout

Please see <http://www.diodes.com/package-outlines.html> for the latest version.

SOT23

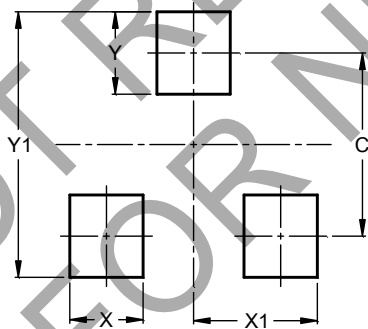

Dimensions	Value (in mm)
C	2.0
X	0.8
X1	1.35
Y	0.9
Y1	2.9

IMPORTANT NOTICE

DIODES INCORPORATED MAKES NO WARRANTY OF ANY KIND, EXPRESS OR IMPLIED, WITH REGARDS TO THIS DOCUMENT, INCLUDING, BUT NOT LIMITED TO, THE IMPLIED WARRANTIES OF MERCHANTABILITY AND FITNESS FOR A PARTICULAR PURPOSE (AND THEIR EQUIVALENTS UNDER THE LAWS OF ANY JURISDICTION).

Diodes Incorporated and its subsidiaries reserve the right to make modifications, enhancements, improvements, corrections or other changes without further notice to this document and any product described herein. Diodes Incorporated does not assume any liability arising out of the application or use of this document or any product described herein; neither does Diodes Incorporated convey any license under its patent or trademark rights, nor the rights of others. Any Customer or user of this document or products described herein in such applications shall assume all risks of such use and will agree to hold Diodes Incorporated and all the companies whose products are represented on Diodes Incorporated website, harmless against all damages.

Diodes Incorporated does not warrant or accept any liability whatsoever in respect of any products purchased through unauthorized sales channel. Should Customers purchase or use Diodes Incorporated products for any unintended or unauthorized application, Customers shall indemnify and hold Diodes Incorporated and its representatives harmless against all claims, damages, expenses, and attorney fees arising out of, directly or indirectly, any claim of personal injury or death associated with such unintended or unauthorized application.

Products described herein may be covered by one or more United States, international or foreign patents pending. Product names and markings noted herein may also be covered by one or more United States, international or foreign trademarks.

This document is written in English but may be translated into multiple languages for reference. Only the English version of this document is the final and determinative format released by Diodes Incorporated.

LIFE SUPPORT

Diodes Incorporated products are specifically not authorized for use as critical components in life support devices or systems without the express written approval of the Chief Executive Officer of Diodes Incorporated. As used herein:

A. Life support devices or systems are devices or systems which:

1. are intended to implant into the body, or
2. support or sustain life and whose failure to perform when properly used in accordance with instructions for use provided in the labeling can be reasonably expected to result in significant injury to the user.

B. A critical component is any component in a life support device or system whose failure to perform can be reasonably expected to cause the failure of the life support device or to affect its safety or effectiveness.

Customers represent that they have all necessary expertise in the safety and regulatory ramifications of their life support devices or systems, and acknowledge and agree that they are solely responsible for all legal, regulatory and safety-related requirements concerning their products and any use of Diodes Incorporated products in such safety-critical, life support devices or systems, notwithstanding any devices- or systems-related information or support that may be provided by Diodes Incorporated. Further, Customers must fully indemnify Diodes Incorporated and its representatives against any damages arising out of the use of Diodes Incorporated products in such safety-critical, life support devices or systems.

Copyright © 2017, Diodes Incorporated

www.diodes.com

Looking for pricing, stock, or lifecycle information?

Click below to explore more details on WIN SOURCE:

 [View APX803-31SAG-7 on WIN SOURCE](#)

 [Diodes Incorporated](#) Information

Optimize Your Supply Chain with WIN SOURCE Solutions

-  Global Sourcing Solution
-  Obsolete Management
-  Cost Control Management
-  Shortage Management
-  Alternative Solution
-  Excess Inventory Management