



**THE DATASHEET OF
APT25GP120BDQ1G**



POWER MOS 7® IGBT

The POWER MOS 7® IGBT is a new generation of high voltage power IGBTs. Using Punch Through Technology this IGBT is ideal for many high frequency, high voltage switching applications and has been optimized for high frequency switchmode power supplies.

- **Low Conduction Loss**
- **Low Gate Charge**
- **Ultrafast Tail Current shutoff**
- **100 kHz operation @ 800V, 11A**
- **50 kHz operation @ 800V, 19A**
- **RBSOA Rated**

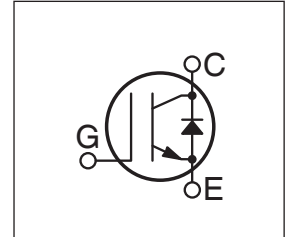
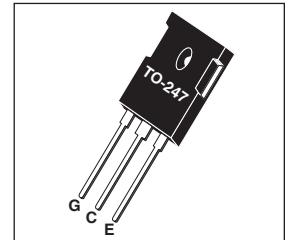

MAXIMUM RATINGS

All Ratings: $T_C = 25^\circ\text{C}$ unless otherwise specified.

Symbol	Parameter	APT25GP120BDQ1(G)	UNIT
V_{CES}	Collector-Emitter Voltage	1200	Volts
V_{GE}	Gate-Emitter Voltage	± 30	
I_{C1}	Continuous Collector Current @ $T_C = 25^\circ\text{C}$	69	Amps
I_{C2}	Continuous Collector Current @ $T_C = 110^\circ\text{C}$	33	
I_{CM}	Pulsed Collector Current ^① @ $T_C = 150^\circ\text{C}$	90	
RBSOA	Reverse Bias Safe Operating Area @ $T_j = 150^\circ\text{C}$	90A @ 960V	
P_D	Total Power Dissipation	417	Watts
T_J, T_{STG}	Operating and Storage Junction Temperature Range	-55 to 150	$^\circ\text{C}$
T_L	Max. Lead Temp. for Soldering: 0.063" from Case for 10 Sec.	300	

STATIC ELECTRICAL CHARACTERISTICS

Symbol	Characteristic / Test Conditions	MIN	TYP	MAX	Units
$V_{(BR)CES}$	Collector-Emitter Breakdown Voltage ($V_{GE} = 0V, I_C = 350\mu\text{A}$)	1200			Volts
$V_{GE(TH)}$	Gate Threshold Voltage ($V_{CE} = V_{GE}, I_C = 1\text{mA}, T_j = 25^\circ\text{C}$)	3	4.5	6	
$V_{CE(ON)}$	Collector-Emitter On Voltage ($V_{GE} = 15V, I_C = 25A, T_j = 25^\circ\text{C}$)		3.3	3.9	
	Collector-Emitter On Voltage ($V_{GE} = 15V, I_C = 25A, T_j = 125^\circ\text{C}$)		3.0		
I_{CES}	Collector Cut-off Current ($V_{CE} = 1200V, V_{GE} = 0V, T_j = 25^\circ\text{C}$) ^②			350	μA
	Collector Cut-off Current ($V_{CE} = 1200V, V_{GE} = 0V, T_j = 125^\circ\text{C}$) ^②			3000	
I_{GES}	Gate-Emitter Leakage Current ($V_{GE} = \pm 20V$)			± 100	nA



CAUTION: These Devices are Sensitive to Electrostatic Discharge. Proper Handling Procedures Should Be Followed.

DYNAMIC CHARACTERISTICS

APT25GP120BDQ1(G)

Symbol	Characteristic	Test Conditions	MIN	TYP	MAX	UNIT	
C_{ies}	Input Capacitance	Capacitance $V_{GE} = 0V, V_{CE} = 25V$ $f = 1 \text{ MHz}$		2090		pF	
C_{oes}	Output Capacitance			200			
C_{res}	Reverse Transfer Capacitance			40			
V_{GEP}	Gate-to-Emitter Plateau Voltage	Gate Charge		7.5		V	
Q_g	Total Gate Charge ⁽³⁾	$V_{GE} = 15V$		110		nC	
Q_{ge}	Gate-Emitter Charge	$V_{CE} = 600V$		15			
Q_{gc}	Gate-Collector ("Miller") Charge	$I_C = 25A$		50			
RBSOA	Reverse Bias Safe Operating Area	$T_J = 150^\circ C, R_G = 5\Omega, V_{GE} = 15V, L = 100\mu H, V_{CE} = 960V$	90			A	
$t_{d(on)}$	Turn-on Delay Time	Inductive Switching (25°C) $V_{CC} = 600V$ $V_{GE} = 15V$ $I_C = 25A$ $R_G = 5\Omega$ $T_J = +25^\circ C$		12		ns	
t_r	Current Rise Time			14			
$t_{d(off)}$	Turn-off Delay Time			70			
t_f	Current Fall Time			39			
E_{on1}	Turn-on Switching Energy ⁽⁴⁾			500			μJ
E_{on2}	Turn-on Switching Energy (Diode) ⁽⁵⁾		1090				
E_{off}	Turn-off Switching Energy ⁽⁶⁾		440				
$t_{d(on)}$	Turn-on Delay Time	Inductive Switching (125°C) $V_{CC} = 600V$ $V_{GE} = 15V$ $I_C = 25A$ $R_G = 5\Omega$ $T_J = +125^\circ C$		12		ns	
t_r	Current Rise Time			14			
$t_{d(off)}$	Turn-off Delay Time			110			
t_f	Current Fall Time			90			
E_{on1}	Turn-on Switching Energy ⁽⁴⁾			500			μJ
E_{on2}	Turn-on Switching Energy (Diode) ⁽⁵⁾			1575			
E_{off}	Turn-off Switching Energy ⁽⁶⁾			1185			

THERMAL AND MECHANICAL CHARACTERISTICS

Symbol	Characteristic	MIN	TYP	MAX	UNIT
$R_{\theta JC}$	Junction to Case (IGBT)			.30	°C/W
$R_{\theta JC}$	Junction to Case (DIODE)			1.18	
W_T	Package Weight		5.9		gm

① Repetitive Rating: Pulse width limited by maximum junction temperature.

② For Combi devices, I_{ces} includes both IGBT and FRED leakages

③ See MIL-STD-750 Method 3471.

④ E_{on1} is the clamped inductive turn-on-energy of the IGBT only, without the effect of a commutating diode reverse recovery current adding to the IGBT turn-on loss. (See Figure 24.)

⑤ E_{on2} is the clamped inductive turn-on energy that includes a commutating diode reverse recovery current in the IGBT turn-on switching loss. (See Figures 21, 22.)

⑥ E_{off} is the clamped inductive turn-off energy measured in accordance with JEDEC standard JESD24-1. (See Figures 21, 23.)

APT Reserves the right to change, without notice, the specifications and information contained herein.

TYPICAL PERFORMANCE CURVES

APT25GP120BDQ1(G)

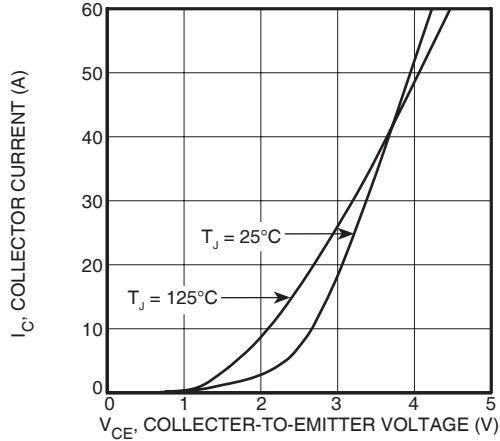

FIGURE 1, Output Characteristics($T_J = 25^\circ\text{C}$)

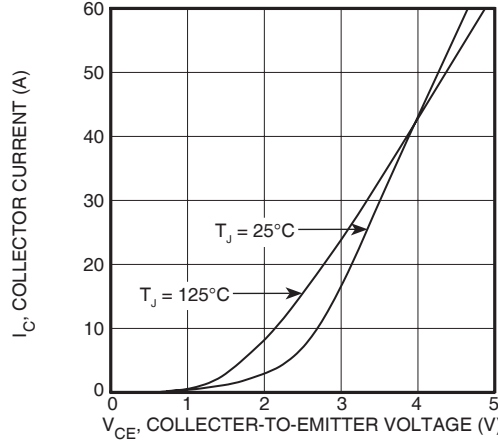

FIGURE 2, Output Characteristics ($T_J = 125^\circ\text{C}$)

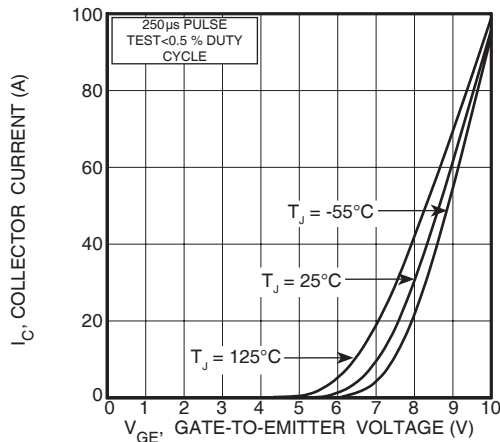

FIGURE 3, Transfer Characteristics

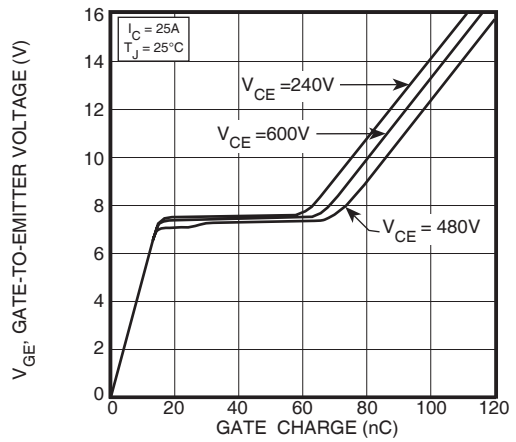

FIGURE 4, Gate Charge

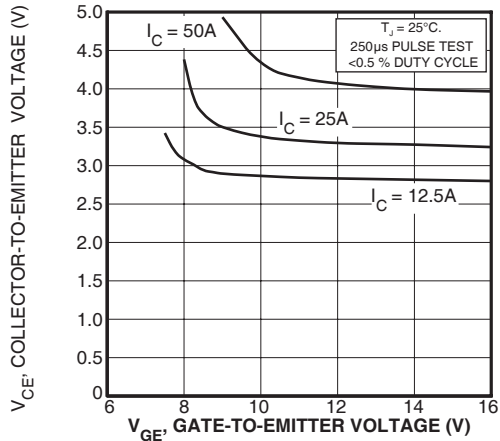

FIGURE 5, On State Voltage vs Gate-to-Emitter Voltage

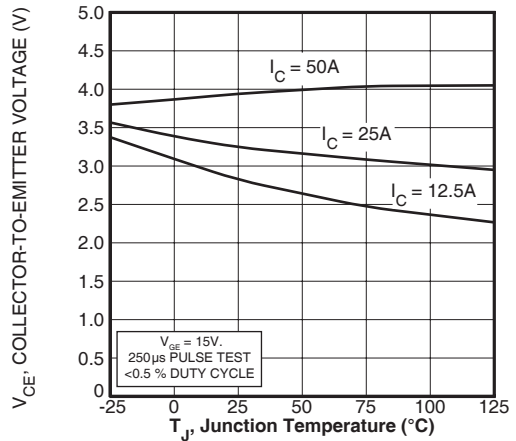

FIGURE 6, On State Voltage vs Junction Temperature

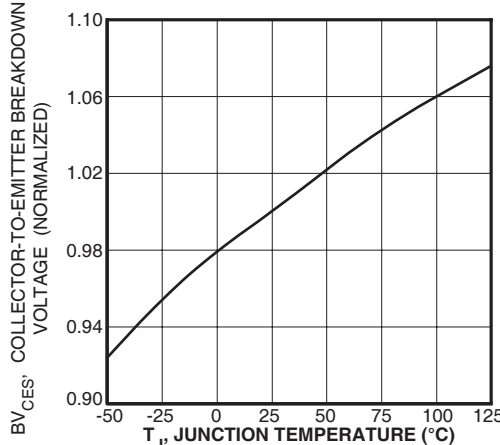

FIGURE 7, Breakdown Voltage vs. Junction Temperature

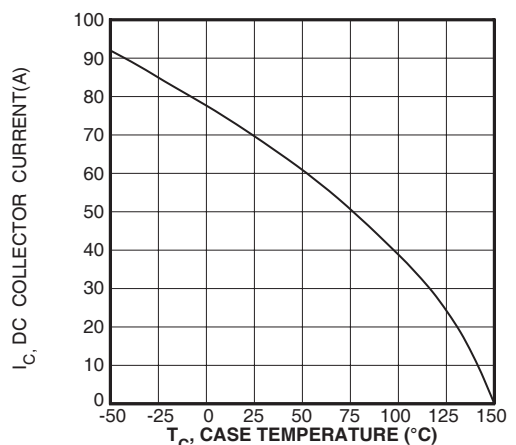

FIGURE 8, DC Collector Current vs Case Temperature

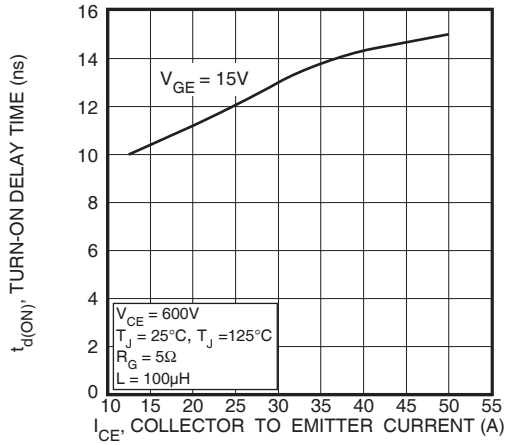

FIGURE 9, Turn-On Delay Time vs Collector Current

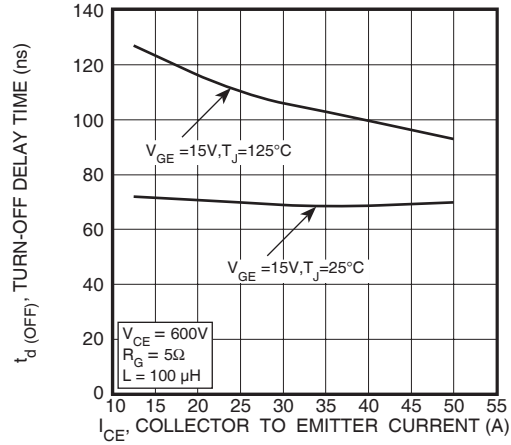

FIGURE 10, Turn-Off Delay Time vs Collector Current

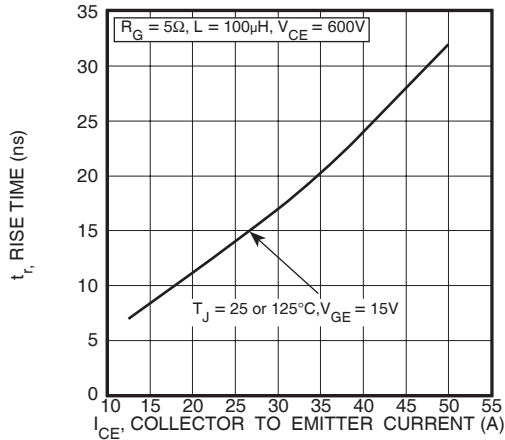

FIGURE 11, Current Rise Time vs Collector Current

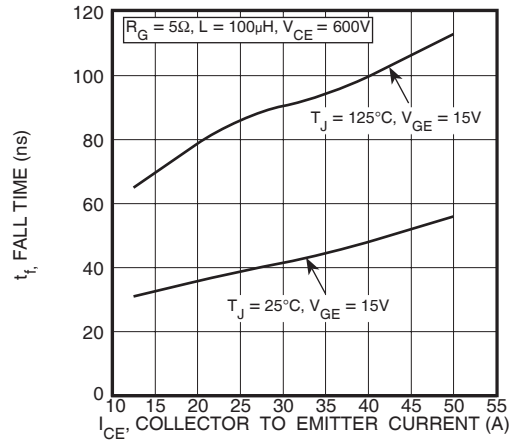

FIGURE 12, Current Fall Time vs Collector Current

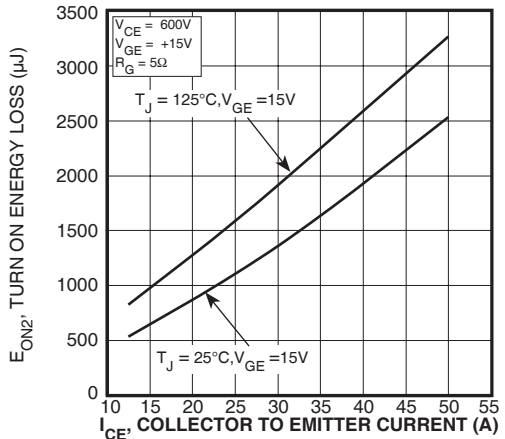

FIGURE 13, Turn-On Energy Loss vs Collector Current

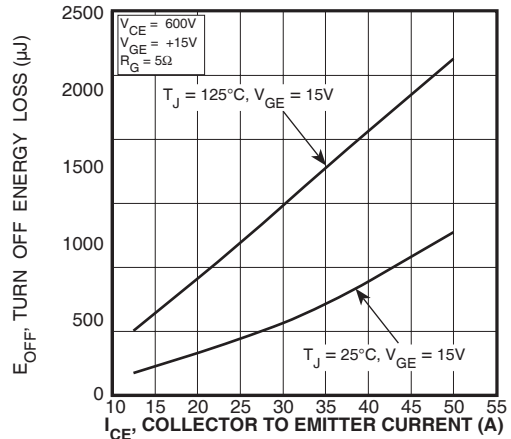

FIGURE 14, Turn Off Energy Loss vs Collector Current

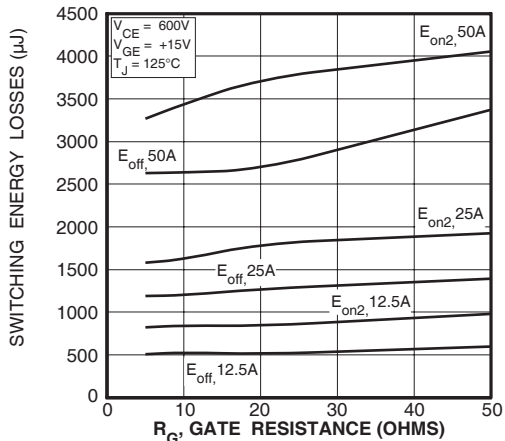

FIGURE 15, Switching Energy Losses vs. Gate Resistance

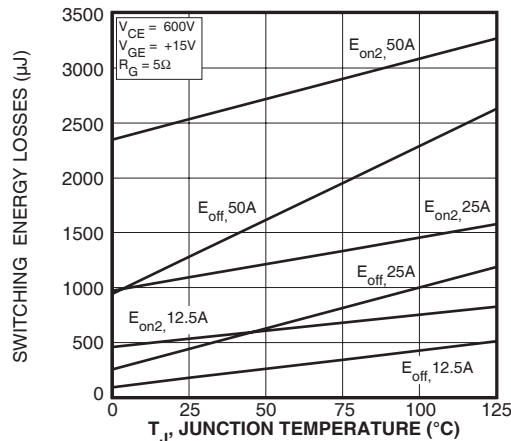

FIGURE 16, Switching Energy Losses vs Junction Temperature

TYPICAL PERFORMANCE CURVES

APT25GP120BDQ1(G)

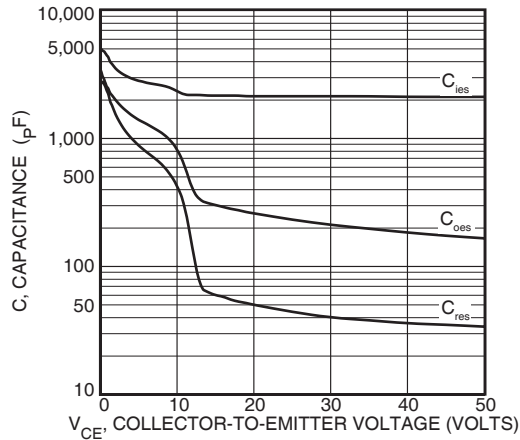

Figure 17, Capacitance vs Collector-To-Emitter Voltage

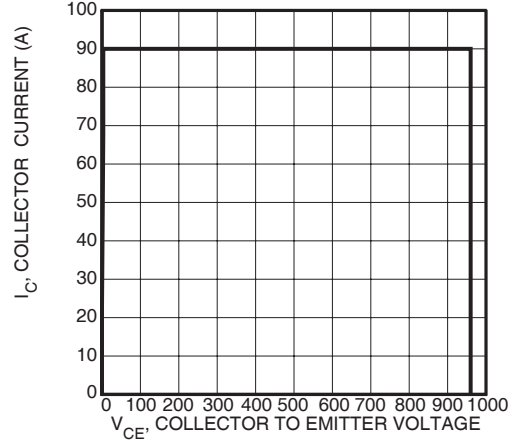

Figure 18, Minimum Switching Safe Operating Area

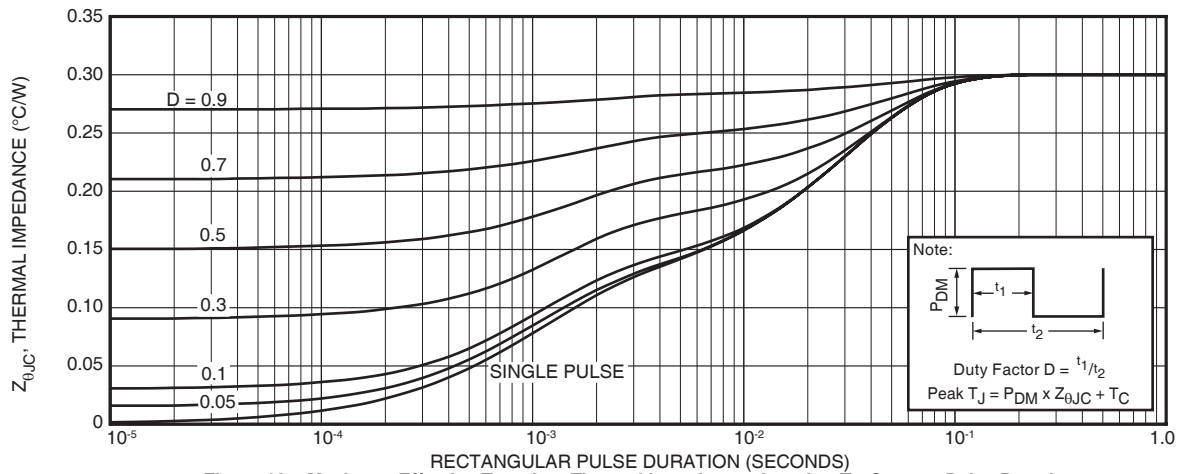

Figure 19a, Maximum Effective Transient Thermal Impedance, Junction-To-Case vs Pulse Duration

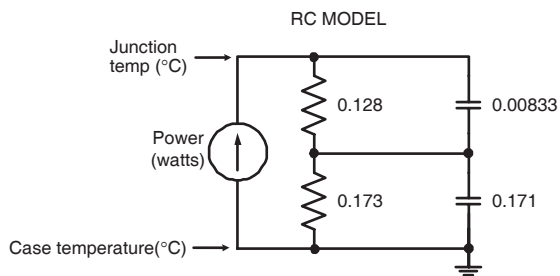

FIGURE 19b, TRANSIENT THERMAL IMPEDANCE MODEL

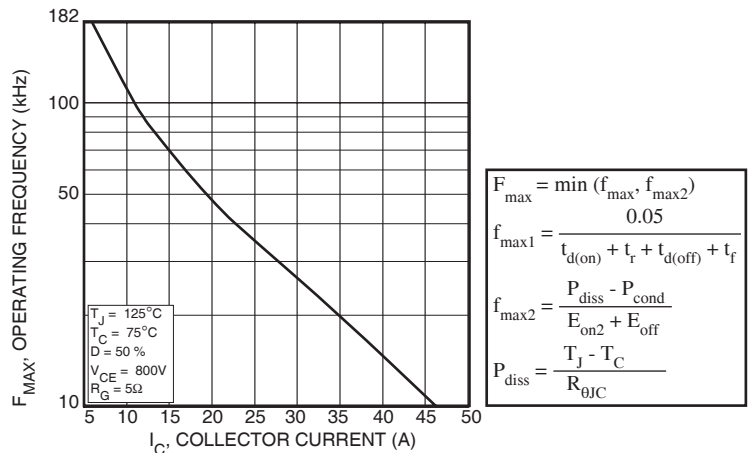

Figure 20, Operating Frequency vs Collector Current

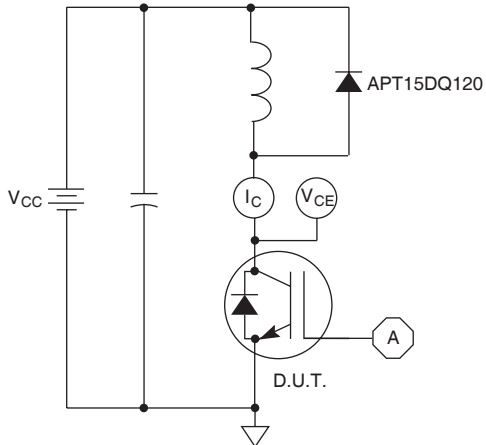

Figure 21, Inductive Switching Test Circuit

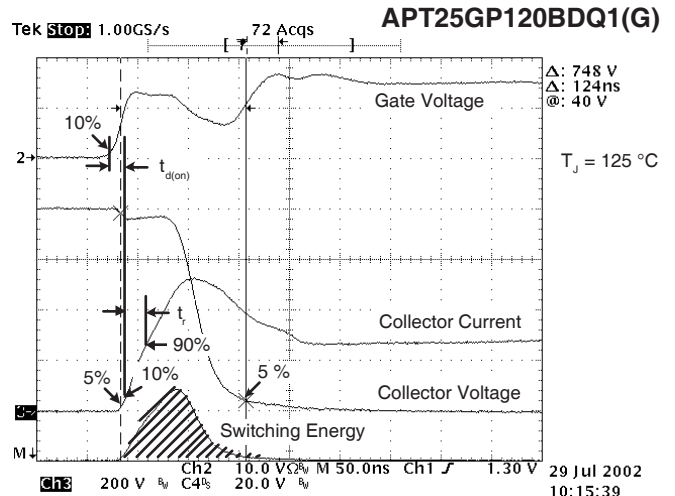

Figure 22, Turn-on Switching Waveforms and Definitions

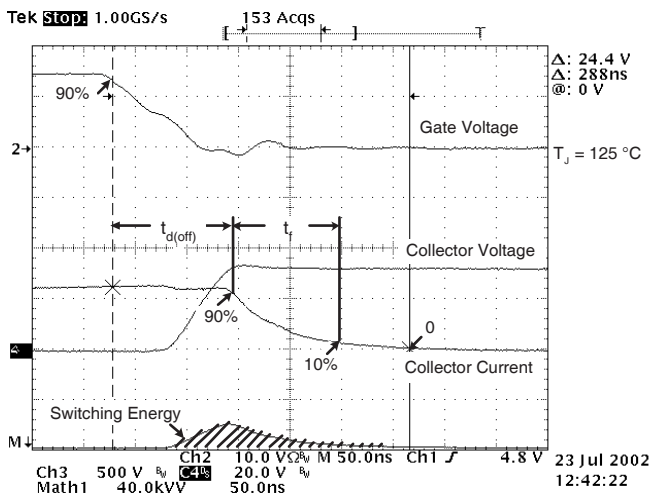

Figure 23, Turn-off Switching Waveforms and Definitions

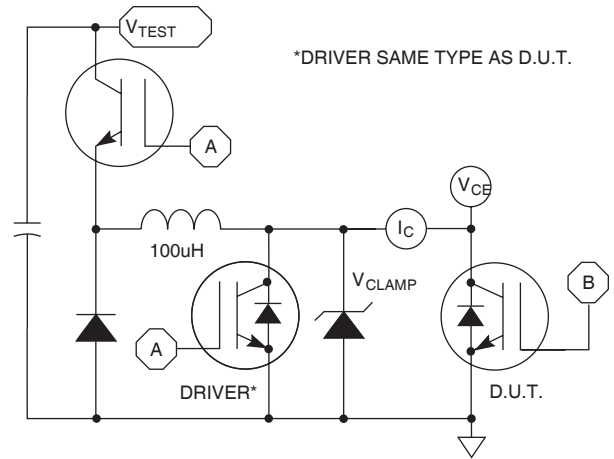

Figure 24, E_{ON1} Test Circuit

ULTRAFAST SOFT RECOVERY ANTI-PARALLEL DIODE

MAXIMUM RATINGS

All Ratings: $T_C = 25^\circ\text{C}$ unless otherwise specified.

Symbol	Characteristic / Test Conditions	APT25GP120BDQ1(G)		UNIT
$I_F(\text{AV})$	Maximum Average Forward Current ($T_C = 127^\circ\text{C}$, Duty Cycle = 0.5)		15	Amps
$I_F(\text{RMS})$	RMS Forward Current (Square wave, 50% duty)		29	
I_{FSM}	Non-Repetitive Forward Surge Current ($T_J = 45^\circ\text{C}$, 8.3ms)		110	

STATIC ELECTRICAL CHARACTERISTICS

Symbol	Characteristic / Test Conditions	MIN	TYP	MAX	UNIT
V_F	Forward Voltage	$I_F = 25\text{A}$		3.24	Volts
		$I_F = 50\text{A}$		4.03	
		$I_F = 25\text{A}, T_J = 125^\circ\text{C}$		2.91	

DYNAMIC CHARACTERISTICS

Symbol	Characteristic	Test Conditions	MIN	TYP	MAX	UNIT
t_{rr}	Reverse Recovery Time	$I_F = 1\text{A}, di_F/dt = -100\text{A}/\mu\text{s}, V_R = 30\text{V}, T_J = 25^\circ\text{C}$	-	21		ns
t_{rr}	Reverse Recovery Time	$I_F = 15\text{A}, di_F/dt = -200\text{A}/\mu\text{s}, V_R = 800\text{V}, T_C = 25^\circ\text{C}$	-	240		
Q_{rr}	Reverse Recovery Charge		-	260		nC
I_{RRM}	Maximum Reverse Recovery Current		-	3	-	Amps
t_{rr}	Reverse Recovery Time	$I_F = 15\text{A}, di_F/dt = -200\text{A}/\mu\text{s}, V_R = 800\text{V}, T_C = 125^\circ\text{C}$	-	290		ns
Q_{rr}	Reverse Recovery Charge		-	960		nC
I_{RRM}	Maximum Reverse Recovery Current		-	6	-	Amps
t_{rr}	Reverse Recovery Time	$I_F = 15\text{A}, di_F/dt = -1000\text{A}/\mu\text{s}, V_R = 800\text{V}, T_C = 125^\circ\text{C}$	-	130		ns
Q_{rr}	Reverse Recovery Charge		-	1340		nC
I_{RRM}	Maximum Reverse Recovery Current		-	19		Amps

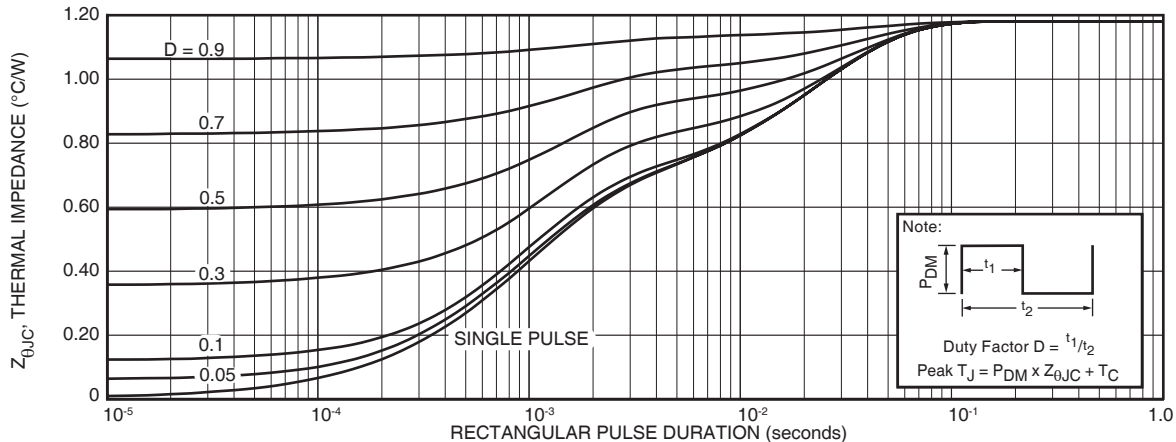

FIGURE 25a. MAXIMUM EFFECTIVE TRANSIENT THERMAL IMPEDANCE, JUNCTION-TO-CASE vs. PULSE DURATION

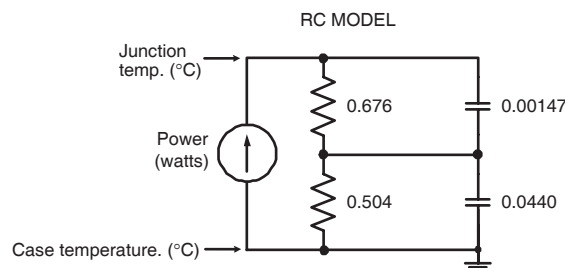

FIGURE 25b. TRANSIENT THERMAL IMPEDANCE MODEL

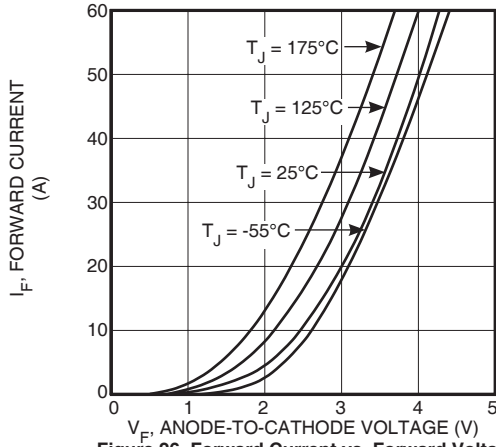

Figure 26. Forward Current vs. Forward Voltage

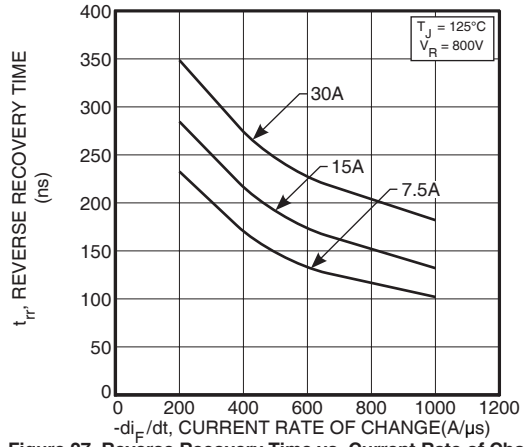

Figure 27. Reverse Recovery Time vs. Current Rate of Change

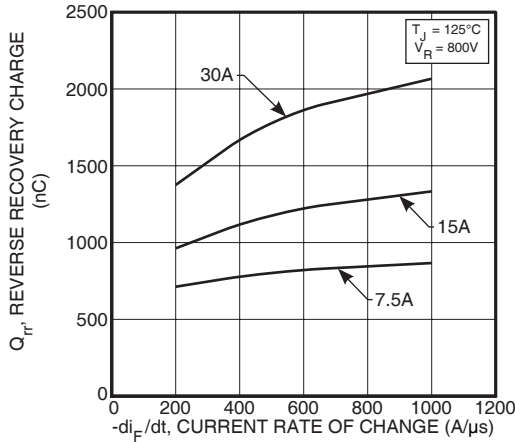

Figure 28. Reverse Recovery Charge vs. Current Rate of Change

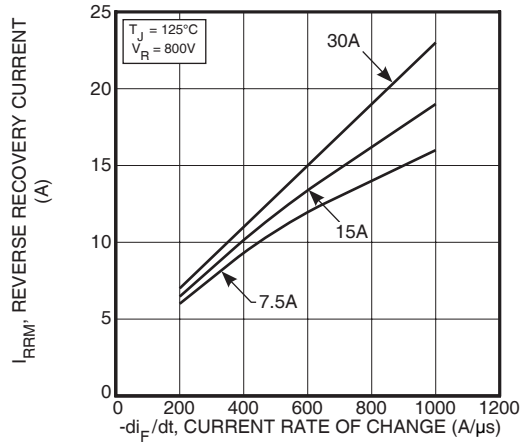

Figure 29. Reverse Recovery Current vs. Current Rate of Change

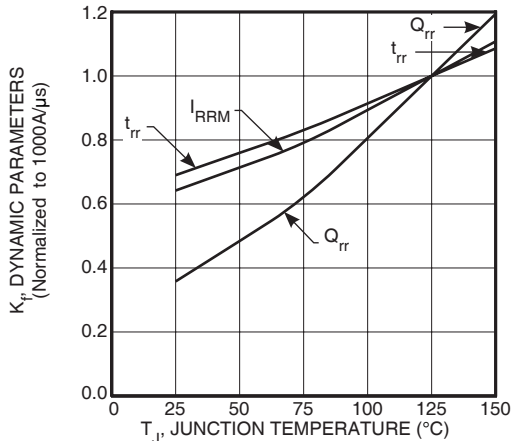

Figure 30. Dynamic Parameters vs. Junction Temperature

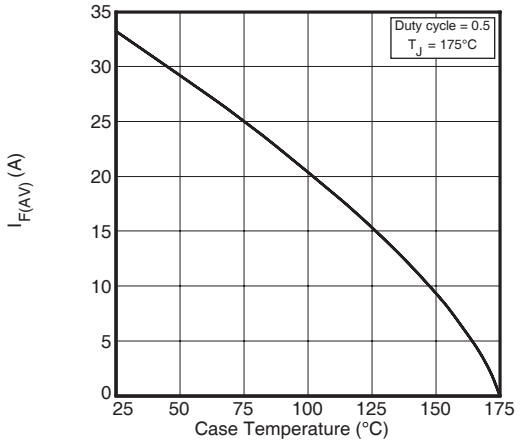

Figure 31. Maximum Average Forward Current vs. Case Temperature

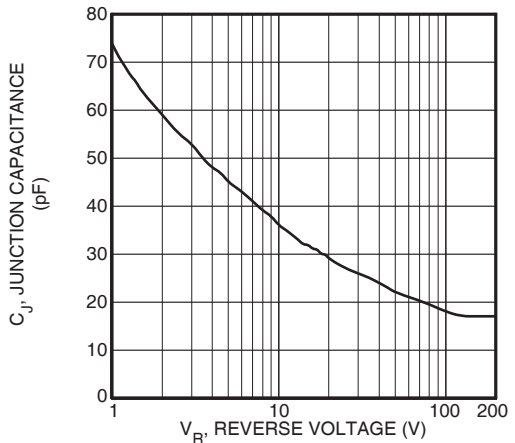

Figure 32. Junction Capacitance vs. Reverse Voltage

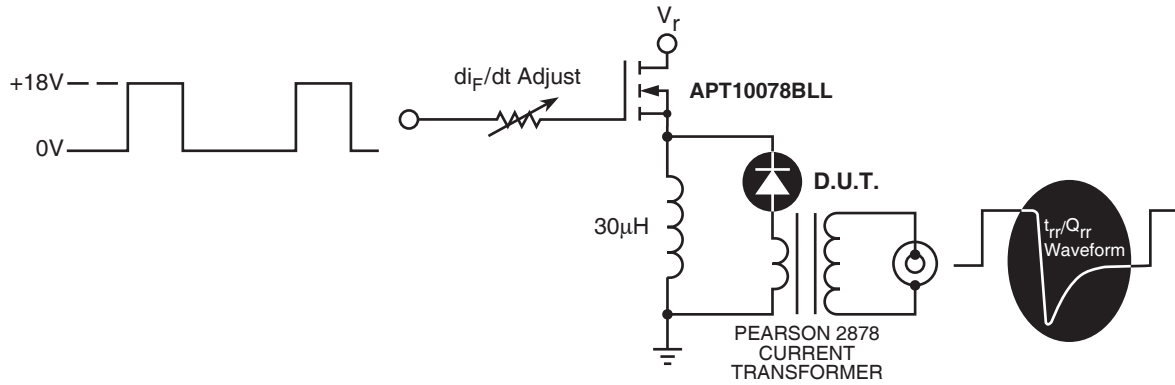

Figure 33. Diode Test Circuit

- 1 I_F - Forward Conduction Current
- 2 di_F/dt - Rate of Diode Current Change Through Zero Crossing.
- 3 I_{RRM} - Maximum Reverse Recovery Current.
- 4 t_{rr} - Reverse Recovery Time, measured from zero crossing where diode current goes from positive to negative, to the point at which the straight line through I_{RRM} and $0.25 \cdot I_{RRM}$ passes through zero.
- 5 Q_{rr} - Area Under the Curve Defined by I_{RRM} and t_{rr} .

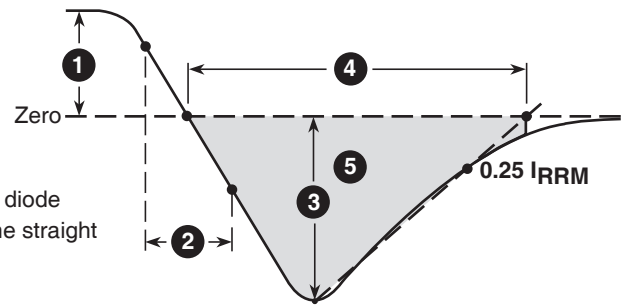
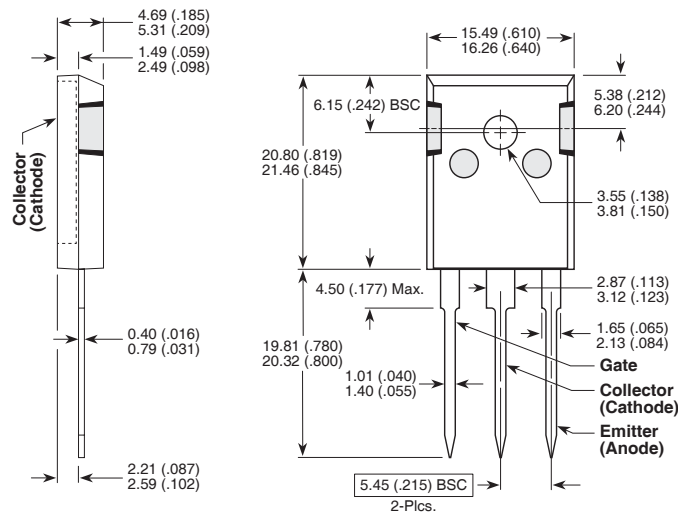

Figure 34. Diode Reverse Recovery Waveform and Definitions

TO-247 Package Outline

ⓔ1 SAC: Tin, Silver, Copper



Dimensions in Millimeters and (Inches)

APT's products are covered by one or more of U.S. patents 4,895,810 5,045,903 5,089,434 5,182,234 5,019,522 5,262,336 6,503,786 5,256,583 4,748,103 5,283,202 5,231,474 5,434,095 5,528,058 and foreign patents. US and Foreign patents pending. All Rights Reserved.

Looking for pricing, stock, or lifecycle information?

Click below to explore more details on WIN SOURCE:

 [View APT25GP120BDQ1G on WIN SOURCE](#)

 [Microsemi Corporation](#) Information

Optimize Your Supply Chain with WIN SOURCE Solutions

-  Global Sourcing Solution
-  Obsolete Management
-  Cost Control Management
-  Shortage Management
-  Alternative Solution
-  Excess Inventory Management