



THE DATASHEET OF STTH30L06CT



Turbo 2 ultratfast high voltage rectifier

Datasheet - production data

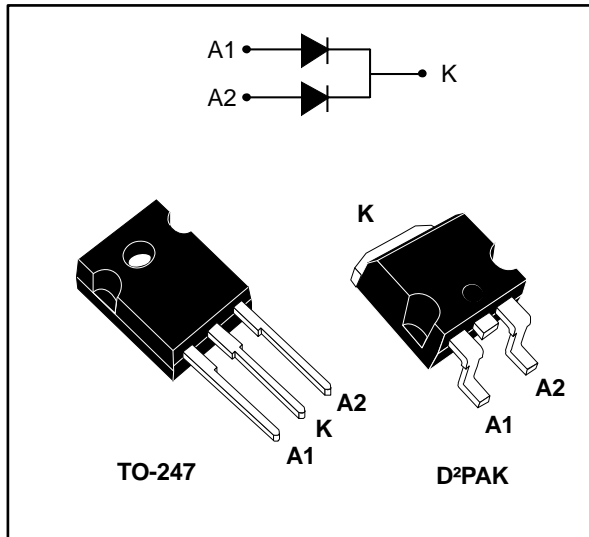
Description

This device uses ST Turbo 2 600 V technology, and is particularly suited as boost diode in discontinuous or critical mode power factor corrections.

It is also intended for use as a freewheeling diode in power supplies and other power switching applications.

Table 1: Device summary

Symbol	Value
$I_{F(AV)}$	up to 2 x 20 A
V_{RRM}	600 V
V_F (typ.)	0.95 V
t_{rr} (max.)	55 ns

Features

- Ultrafast switching
- Low reverse current
- Low thermal resistance
- Reduce switching and conduction losses
- ECOPACK[®]2 compliant component for D²PAK on demand

1 Characteristics

Table 2: Absolute ratings (limiting values, per diode, at 25 °C, unless otherwise specified)

Symbol	Parameter		Value	Unit	
V _{RRM}	Repetitive peak reverse voltage		600	V	
I _{F(RMS)}	Forward rms current		30	A	
I _{F(AV)}	Average forward current $\delta = 0.5$, square wave	T _C = 140 °C	Per diode	15	A
		T _C = 125 °C	Per device	30	
		T _C = 120 °C	Per diode	20	
		T _C = 110 °C	Per device	40	
I _{FSM}	Surge non repetitive forward current	t _p = 10 ms sinusoidal	130	A	
T _{stg}	Storage temperature range		-65 to +175	°C	
T _j	Maximum operating junction temperature		+175	°C	

Table 3: Thermal parameters

Symbol	Parameter		Max. value	Unit
R _{th(j-c)}	Junction to case	Per diode	1.7	°C/W
		Total	1.15	
R _{th(c)}	Coupling		0.6	°C/W

When the diodes 1 and 2 are used simultaneously:

$$\Delta T_j (\text{diode1}) = P_{(\text{diode1})} \times R_{\text{th(j-c)}} (\text{per diode}) + P_{(\text{diode2})} \times R_{\text{th(c)}}$$

Table 4: Static electrical characteristics (per diode)

Symbol	Parameter	Test conditions		Min.	Typ.	Max.	Unit
I _R ⁽¹⁾	Reverse leakage current	T _j = 25 °C	V _R = V _{RRM}	-		15	μA
		T _j = 150 °C		-	40	400	
V _F ⁽²⁾	Forward voltage drop	T _j = 25 °C	I _F = 15 A	-		1.55	V
		T _j = 150 °C		-	0.95	1.2	
		T _j = 25 °C	I _F = 30 A			1.76	
		T _j = 150 °C		1.15	1.45		

Notes:

(1)Pulse test: t_p = 5 ms, $\delta < 2\%$

(2)Pulse test: t_p = 380 μs, $\delta < 2\%$

To evaluate the conduction losses, use the following equation:

$$P = 0.94 \times I_{F(AV)} + 0.017 \times I_{F(RMS)}^2$$

Table 5: Dynamic electrical characteristics (per diode)

Symbol	Parameter	Test conditions		Min.	Typ.	Max.	Unit
t_{rr}	Reverse recovery time	$T_j = 25\text{ °C}$	$I_F = 0.5\text{ A}$ $I_R = 1\text{ A}$ $I_{rr} = 0.25\text{ A}$	-		55	ns
			$I_F = 1\text{ A}$ $V_R = 30\text{ V}$ $di_F/dt = 50\text{ A}/\mu\text{s}$	-	60	85	
I_{RM}	Reverse recovery current	$T_j = 125\text{ °C}$	$I_F = 15\text{ A}$ $V_R = 400\text{ V}$ $di_F/dt = 100\text{ A}/\mu\text{s}$	-	8.5	12	A
t_{fr}	Forward recovery time	$T_j = 25\text{ °C}$	$I_F = 15\text{ A}$ $V_{FR} = 1.1 \times V_{Fmax.}$ $di_F/dt = 100\text{ A}/\mu\text{s}$	-		300	ns
V_{FP}	Forward recovery voltage			-	3.0		V

1.1 Characteristics (curves)

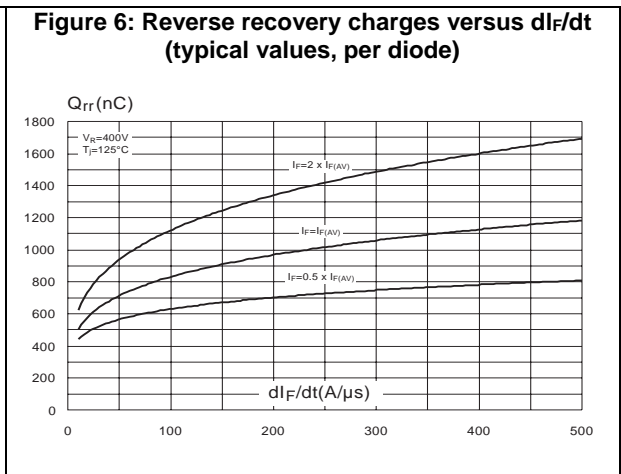
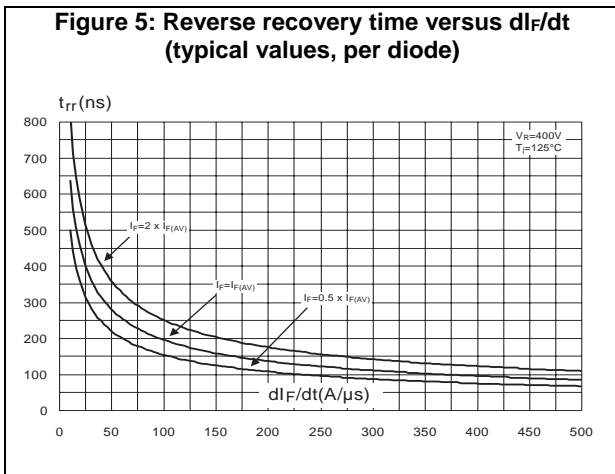
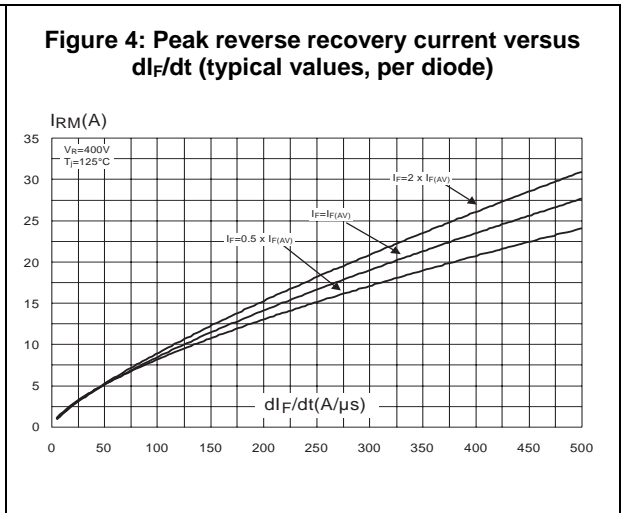
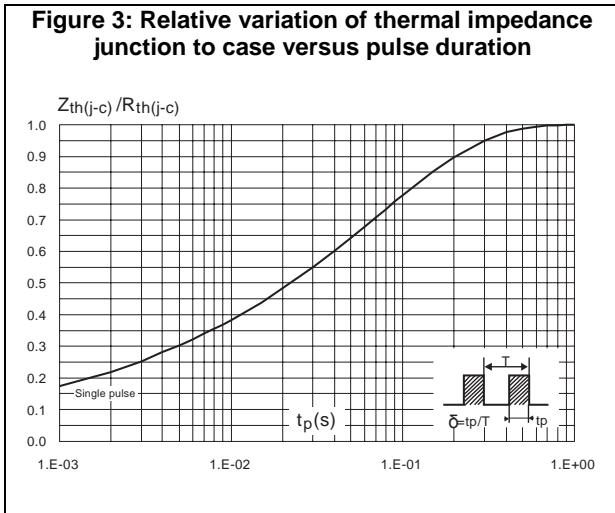
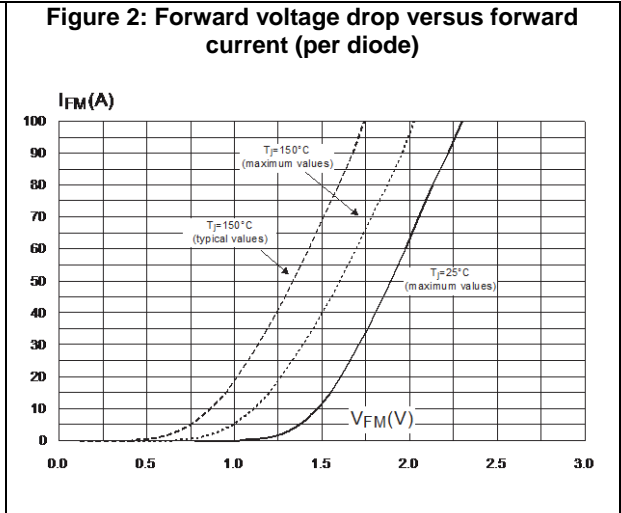
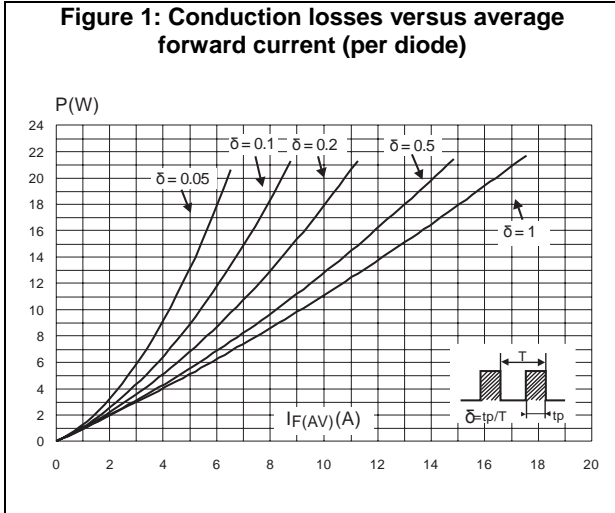

Figure 7: Reverse recovery softness factor versus di_F/dt (typical values, per diode)

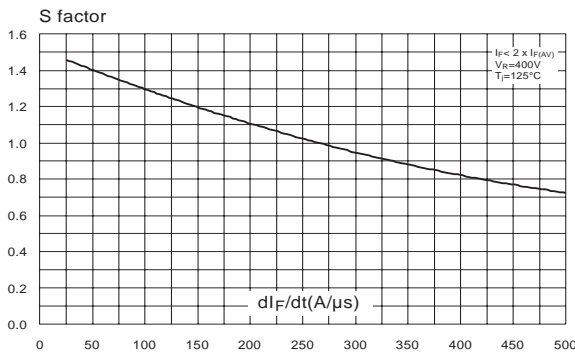

Figure 8: Relative variation of dynamic parameters versus junction temperature

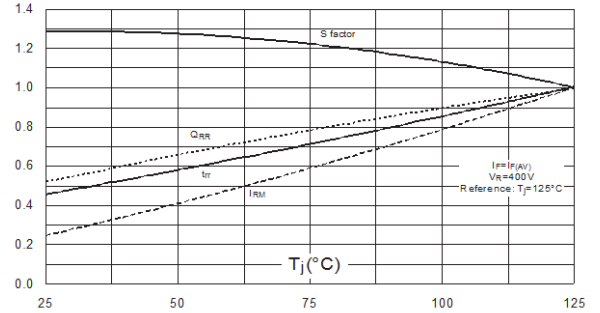

Figure 9: Transient peak forward voltage versus di_F/dt (typical values, per diode)

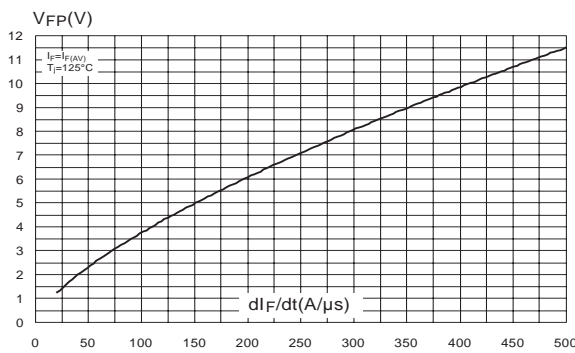

Figure 10: Forward recovery time versus di_F/dt (typical values, per diode)

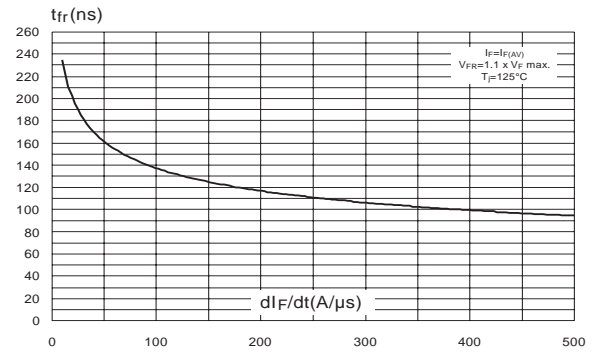

Figure 11: Junction capacitance versus reverse voltage applied (typical values, per diode)

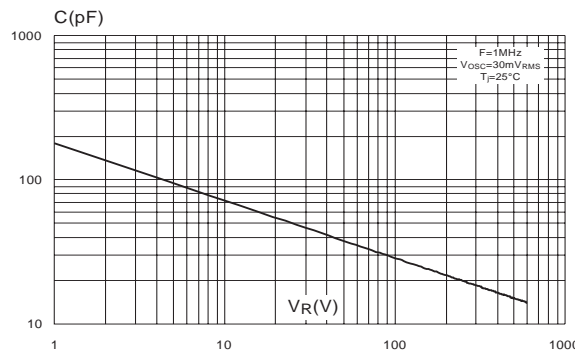
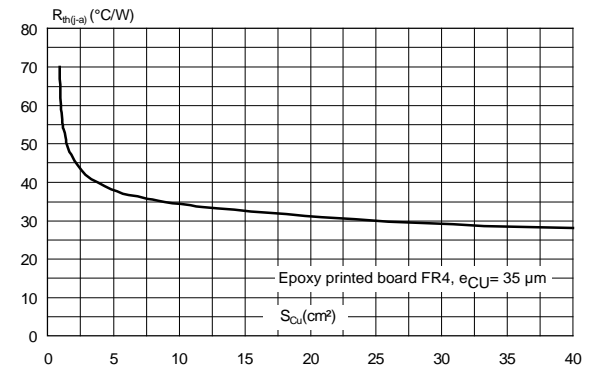

Figure 12: Thermal resistance, junction to ambient, versus copper surface under tab (D²PAK)



2 Package information

In order to meet environmental requirements, ST offers these devices in different grades of ECOPACK® packages, depending on their level of environmental compliance. ECOPACK® specifications, grade definitions and product status are available at: www.st.com. ECOPACK® is an ST trademark.

- Cooling method: by conduction (C)
- Epoxy meets UL 94, V0
- Recommended torque value: 0.8 N·m
- Maximum torque value: 1.0 N·m

2.1 D²PAK package information

Figure 13: D²PAK package outline

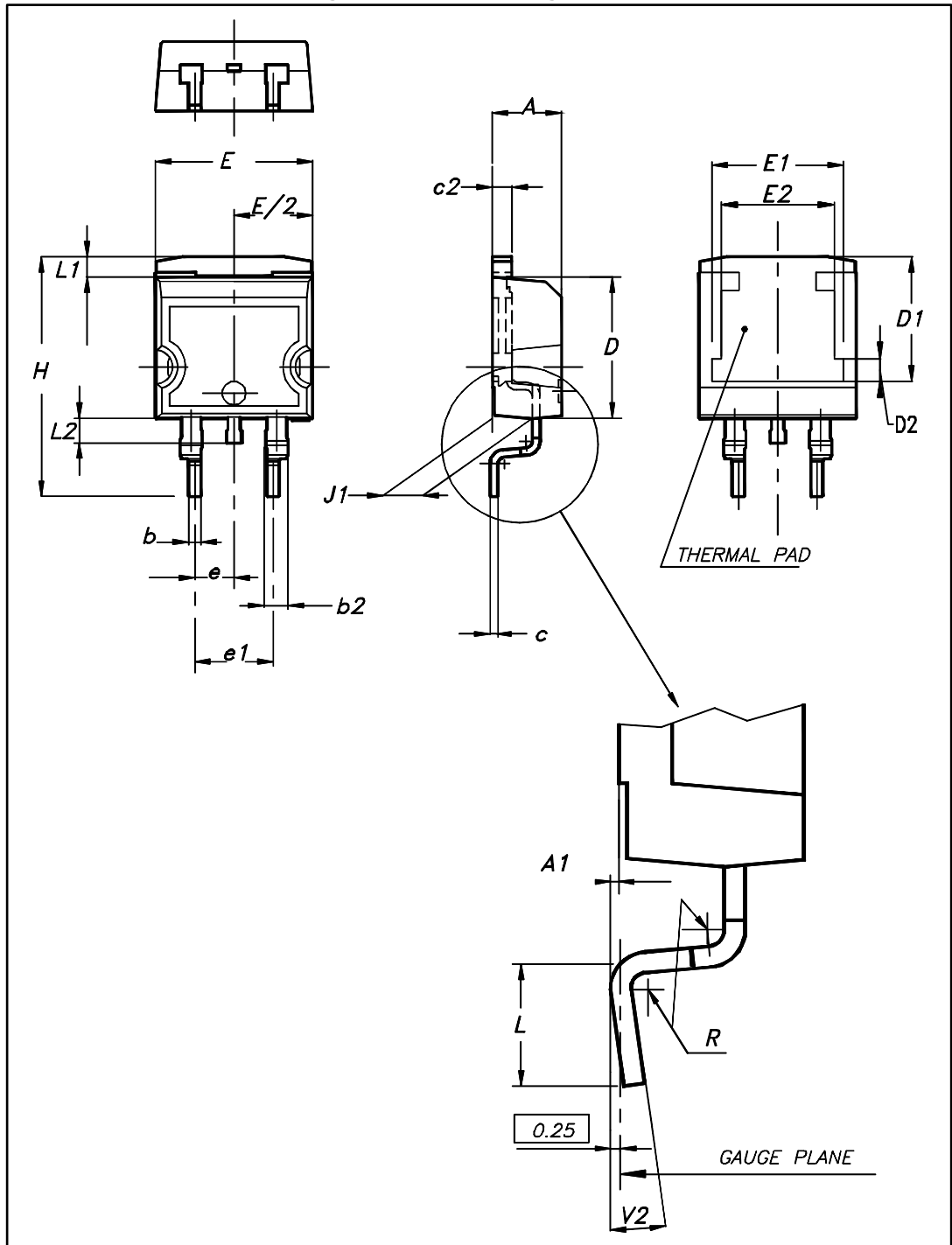

This package drawing may slightly differ from the physical package. However, all the specified dimensions are guaranteed.

Table 6: D²PAK package mechanical data

Ref.	Dimensions			
	Millimeters		Inches	
	Min.	Max.	Min.	Max.
A	4.36	4.60	0.172	0.181
A1	0.00	0.25	0.000	0.010
b	0.70	0.93	0.028	0.037
b2	1.14	1.70	0.045	0.067
c	0.38	0.69	0.015	0.027
c2	1.19	1.36	0.047	0.053
D	8.60	9.35	0.339	0.368
D1	6.90	8.00	0.272	0.311
D2	1.10	1.50	0.043	0.060
E	10.00	10.55	0.394	0.415
E1	8.10	8.90	0.319	0.346
E2	6.85	7.25	0.266	0.282
e	2.54 typ.		0.100	
e1	4.88	5.28	0.190	0.205
H	15.00	15.85	0.591	0.624
J1	2.49	2.90	0.097	0.112
L	1.90	2.79	0.075	0.110
L1	1.27	1.65	0.049	0.065
L2	1.30	1.78	0.050	0.070
R	0.4 typ.		0.015	
V2	0°	8°	0°	8°

Figure 14: D²PAK recommended footprint (dimensions in mm)

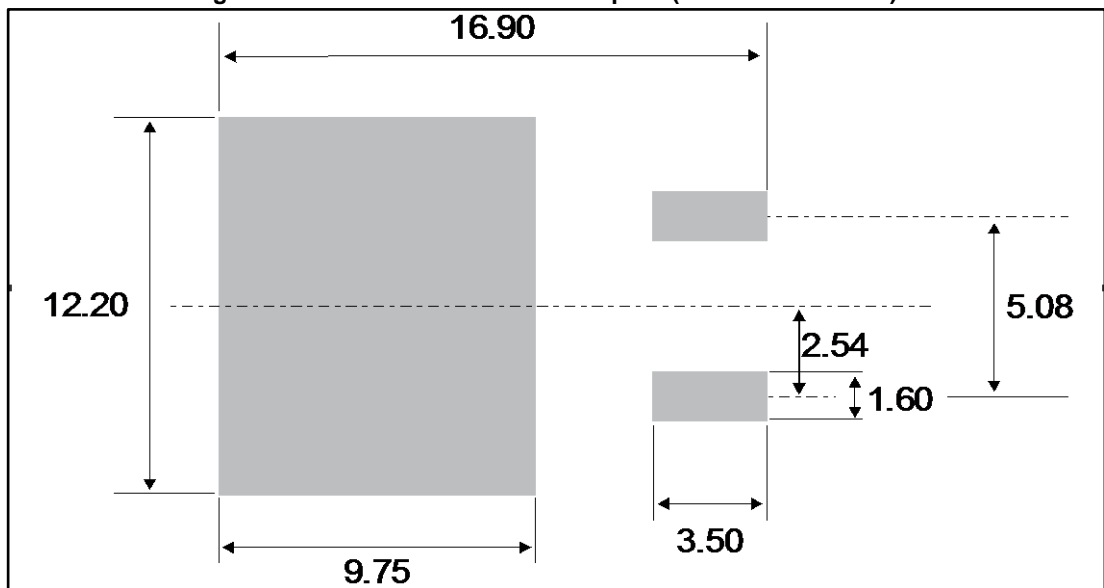

2.2 TO-247 package information

Figure 15: TO-247 package outline

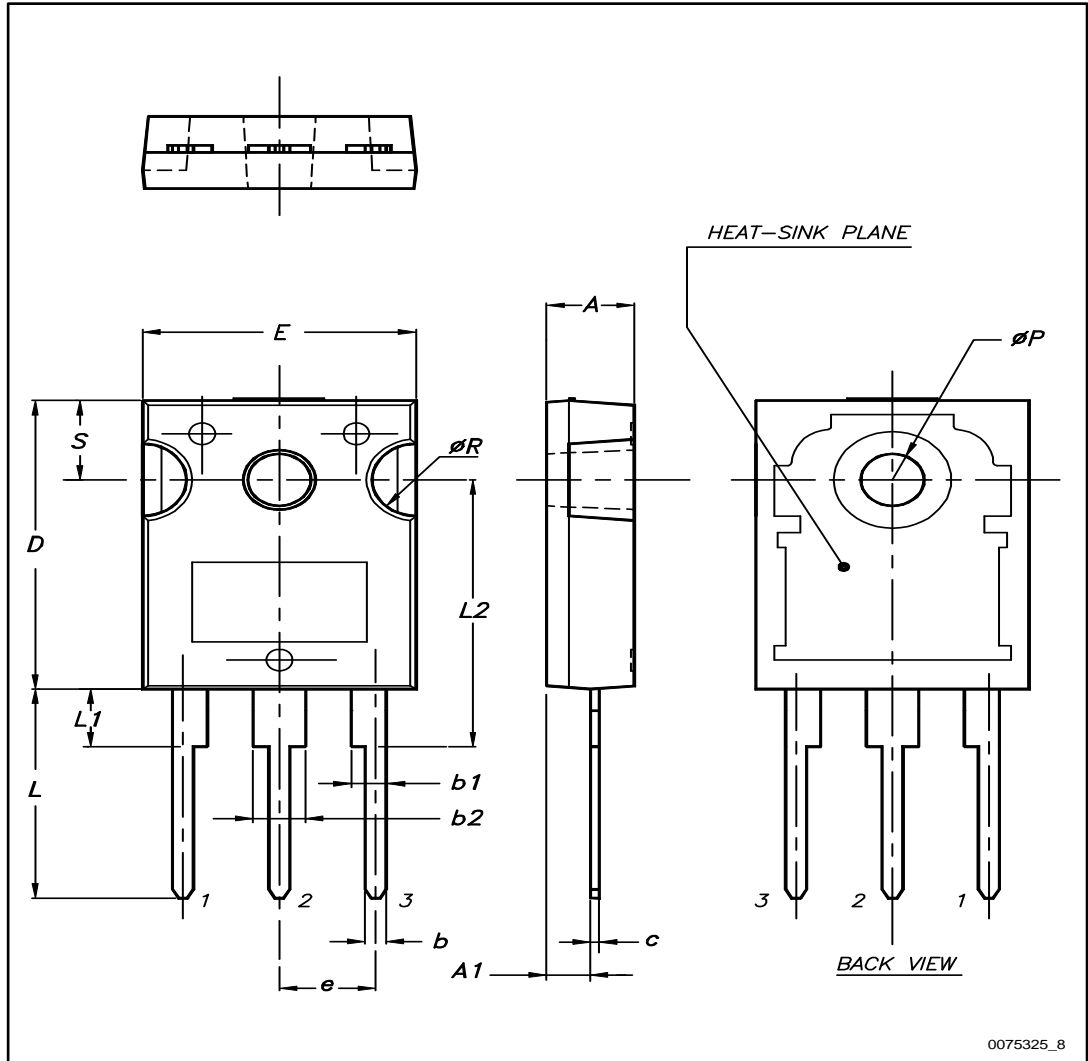

Table 7: TO-247 package mechanical data

Ref.	Dimensions					
	Millimeters			Inches		
	Min.	Typ.	Max.	Min.	Typ.	Max.
A	4.85		5.15	0.191		0.203
A1	2.20		2.60	0.086		0.102
b	1.00		1.40	0.039		0.055
b1	2.00		2.40	0.078		0.094
b2	3.00		3.40	0.118		0.133
c	0.40		0.80	0.015		0.031
D ⁽¹⁾	19.85		20.15	0.781		0.793
E	15.45		15.75	0.608		0.620
e	5.30	5.45	5.60	0.209	0.215	0.220
L	14.20		14.80	0.559		0.582
L1	3.70		4.30	0.145		0.169
L2		18.50			0.728	
ØP ⁽²⁾	3.55		3.65	0.139		0.143
ØR	4.50		5.50	0.177		0.217
S	5.30	5.50	5.70	0.209	0.216	0.224

Notes:

⁽¹⁾Dimension D plus gate protusion does not exceed 20.5 mm

⁽²⁾Resin thickness around the mounting hole is not less than 0.9 mm.

3 Ordering information

Table 8: Ordering information

Order code	Marking	Package	Weight	Base qty.	Delivery mode
STTH30L06CG-TR	STTH30L06CG	D ² PAK	1.48 g	1000	Tape and reel
STTH30L06CW	STTH30L06CW	TO-247	4.46 g	50	Tube

4 Revision history

Table 9: Document revision history

Date	Revision	Changes
07-Sep-2004	1	Initial release.
14-Dec-2016	2	Removed TO-220AB package information.

IMPORTANT NOTICE – PLEASE READ CAREFULLY

STMicroelectronics NV and its subsidiaries ("ST") reserve the right to make changes, corrections, enhancements, modifications, and improvements to ST products and/or to this document at any time without notice. Purchasers should obtain the latest relevant information on ST products before placing orders. ST products are sold pursuant to ST's terms and conditions of sale in place at the time of order acknowledgement.

Purchasers are solely responsible for the choice, selection, and use of ST products and ST assumes no liability for application assistance or the design of Purchasers' products.

No license, express or implied, to any intellectual property right is granted by ST herein.

Resale of ST products with provisions different from the information set forth herein shall void any warranty granted by ST for such product.



ST and the ST logo are trademarks of ST. All other product or service names are the property of their respective owners.

Information in this document supersedes and replaces information previously supplied in any prior versions of this document.







© 2016 STMicroelectronics – All rights reserved

Looking for pricing, stock, or lifecycle information?

Click below to explore more details on WIN SOURCE:

-  [View STTH30L06CT on WIN SOURCE](#)
-  [STMicroelectronics Information](#)

Optimize Your Supply Chain with WIN SOURCE Solutions

-  Global Sourcing Solution
-  Obsolete Management
-  Cost Control Management
-  Shortage Management
-  Alternative Solution
-  Excess Inventory Management