



**THE DATASHEET OF  
1SMA36CAT3G**



# 1SMA10CAT3G Series, SZ1SMA10CAT3G Series

## 400 Watt Peak Power Zener Transient Voltage Suppressors

### Bidirectional

The SMA series is designed to protect voltage sensitive components from high voltage, high energy transients. They have excellent clamping capability, high surge capability, low zener impedance and fast response time. The SMA series is supplied in ON Semiconductor's exclusive, cost-effective, highly reliable SURMETIC® package and is ideally suited for use in communication systems, automotive, numerical controls, process controls, medical equipment, business machines, power supplies and many other industrial/consumer applications.

#### Features

- Working Peak Reverse Voltage Range – 10 V to 78 V
- Standard Zener Breakdown Voltage Range – 11.7 V to 91.3 V
- Peak Power – 400 Watts @ 1 ms
- ESD Rating of Class 3 (> 16 kV) per Human Body Model
- Response Time is Typically < 1 ns
- Flat Handling Surface for Accurate Placement
- Package Design for Top Slide or Bottom Circuit Board Mounting
- Low Profile Package
- SZ Prefix for Automotive and Other Applications Requiring Unique Site and Control Change Requirements; AEC-Q101 Qualified and PPAP Capable
- These are Pb-Free Devices\*

#### Mechanical Characteristics:

**CASE:** Void-free, transfer-molded plastic

**FINISH:** All external surfaces are corrosion resistant and leads are readily solderable

**MAXIMUM CASE TEMPERATURE FOR SOLDERING PURPOSES:**  
260°C for 10 Seconds

**POLARITY:** Cathode polarity notch does not indicate polarity

**MOUNTING POSITION:** Any

\*For additional information on our Pb-Free strategy and soldering details, please download the ON Semiconductor Soldering and Mounting Techniques Reference Manual, SOLDERRM/D.



ON Semiconductor®

[www.onsemi.com](http://www.onsemi.com)

**PLASTIC SURFACE MOUNT  
ZENER OVERVOLTAGE  
TRANSIENT SUPPRESSORS  
10–78 V V<sub>R</sub>  
400 W PEAK POWER**



SMA  
CASE 403D  
PLASTIC



#### MARKING DIAGRAM



xxC = Device Code (Refer to page 3)  
A = Assembly Location  
Y = Year  
WW = Work Week  
▪ = Pb-Free Package

#### ORDERING INFORMATION

| Device**      | Package          | Shipping†              |
|---------------|------------------|------------------------|
| 1SMAxxCAT3G   | SMA<br>(Pb-Free) | 5,000 /<br>Tape & Reel |
| SZ1SMAxxCAT3G | SMA<br>(Pb-Free) | 5,000 /<br>Tape & Reel |

†For information on tape and reel specifications, including part orientation and tape sizes, please refer to our Tape and Reel Packaging Specifications Brochure, BRD8011/D.

\*\*The "T3" suffix refers to a 13 inch reel.

#### DEVICE MARKING INFORMATION

See specific marking information in the device marking column of the Electrical Characteristics table on page 3 of this data sheet.

# 1SMA10CAT3G Series, SZ1SMA10CAT3G Series

## MAXIMUM RATINGS

| Rating  | Symbol          | Value       | Unit                       |
|---|-----------------|-------------|----------------------------|
| Peak Power Dissipation (Note 1) @ $T_L = 25^\circ\text{C}$ , Pulse Width = 1 ms                                       | $P_{PK}$        | 400         | W                          |
| DC Power Dissipation @ $T_L = 75^\circ\text{C}$ Measured Zero Lead Length (Note 2)<br>Derate Above $75^\circ\text{C}$ | $P_D$           | 1.5         | W                          |
| Thermal Resistance from Junction-to-Lead  | $R_{\theta JL}$ | 20          | $\text{mW}/^\circ\text{C}$ |
| DC Power Dissipation (Note 3) @ $T_A = 25^\circ\text{C}$<br>Derate Above $25^\circ\text{C}$                           | $P_D$           | 0.5         | W                          |
| Thermal Resistance from Junction-to-Ambient   | $R_{\theta JA}$ | 4.0         | $\text{mW}/^\circ\text{C}$ |
| Operating and Storage Temperature Range   | $T_J, T_{stg}$  | -65 to +150 | $^\circ\text{C}$           |

Stresses exceeding those listed in the Maximum Ratings table may damage the device. If any of these limits are exceeded, device functionality should not be assumed, damage may occur and reliability may be affected.

- 10 X 1000  $\mu\text{s}$ , non-repetitive.
- 1 in square copper pad, FR-4 board.
- FR-4 board, using ON Semiconductor minimum recommended footprint, as shown in 403B case outline dimensions spec.

## ELECTRICAL CHARACTERISTICS

( $T_A = 25^\circ\text{C}$  unless otherwise noted)

| Symbol    | Parameter                                   |
|-----------|---|
| $I_{PP}$  | Maximum Reverse Peak Pulse Current          |
| $V_C$     | Clamping Voltage @ $I_{PP}$                 |
| $V_{RWM}$ | Working Peak Reverse Voltage                |
| $I_R$     | Maximum Reverse Leakage Current @ $V_{RWM}$ |
| $V_{BR}$  | Breakdown Voltage @ $I_T$                   |
| $I_T$     | Test Current                                |

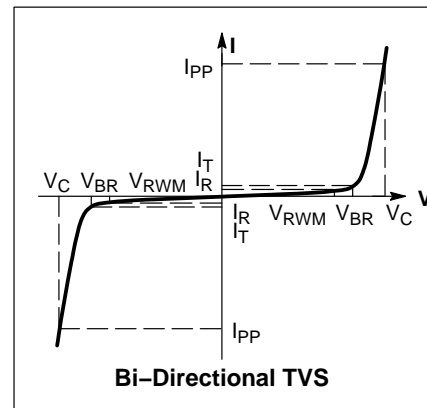

# 1SMA10CAT3G Series, SZ1SMA10CAT3G Series

## ELECTRICAL CHARACTERISTICS

| Device*     | Device Marking | V <sub>RWM</sub><br>(Note 4)<br>Volts | I <sub>R</sub> @ V <sub>RWM</sub><br>μA | Breakdown Voltage                |       |       |                  | V <sub>C</sub> @ I <sub>PP</sub><br>(Note 6) |                 | C Typ.<br>(Note 7)<br>pF |
|-------------|----------------|---------------------------------------|---|----------------------------------|-------|-------|------------------|--|-----------------|--------------------------|
|             |                |                                       |   | V <sub>BR</sub> (Volts) (Note 5) |       |       | @ I <sub>T</sub> | V <sub>C</sub>                               | I <sub>PP</sub> |                          |
|             |                |                                       |   | Min                              | Nom   | Max   | mA               | Volts  | Amps            |                          |
| 1SMA10CAT3G | QXC            | 10                                    | 2.5                                     | 11.1                             | 11.69 | 12.27 | 1.0              | 17.0   | 23.5            | 580                      |
| 1SMA12CAT3G | REC            | 12                                    | 2.5                                     | 13.3                             | 14.00 | 14.70 | 1.0              | 19.9   | 20.1            | 490                      |
| 1SMA13CAT3G | RGC            | 13                                    | 2.5                                     | 14.4                             | 15.16 | 15.92 | 1.0              | 21.5   | 18.6            | 455                      |
| 1SMA15CAT3G | RMC            | 15                                    | 2.5                                     | 16.7                             | 17.58 | 18.46 | 1.0              | 24.4   | 16.4            | 400                      |
| 1SMA16CAT3G | RPC            | 16                                    | 2.5                                     | 17.8                             | 18.74 | 19.67 | 1.0              | 26.0   | 15.4            | 375                      |
| 1SMA18CAT3G | RTC            | 18                                    | 2.5                                     | 20                               | 21.06 | 22.11 | 1.0              | 29.2   | 13.7            | 335                      |
| 1SMA20CAT3G | RVC            | 20                                    | 2.5                                     | 22.2                             | 23.37 | 24.54 | 1.0              | 32.4   | 12.3            | 305                      |
| 1SMA24CAT3G | RZC            | 24                                    | 2.5                                     | 26.7                             | 28.11 | 29.51 | 1.0              | 38.9   | 10.3            | 260                      |
| 1SMA26CAT3G | SEC            | 26                                    | 2.5                                     | 28.9                             | 30.42 | 31.94 | 1.0              | 42.1   | 9.5             | 240                      |
| 1SMA28CAT3G | SGC            | 28                                    | 2.5                                     | 31.1                             | 32.74 | 34.37 | 1.0              | 45.4   | 8.8             | 225                      |
| 1SMA30CAT3G | SKC            | 30                                    | 1.0                                     | 33.3                             | 35.06 | 36.81 | 1.0              | 48.4   | 8.3             | 210                      |
| 1SMA33CAT3G | SMC            | 33                                    | 2.5                                     | 36.7                             | 38.63 | 40.56 | 1.0              | 53.3   | 7.5             | 190                      |
| 1SMA36CAT3G | SPC            | 36                                    | 2.5                                     | 40                               | 42.11 | 44.21 | 1.0              | 58.1   | 6.9             | 175                      |
| 1SMA40CAT3G | SRC            | 40                                    | 2.5                                     | 44.4                             | 46.74 | 49.07 | 1.0              | 64.5   | 6.2             | 160                      |
| 1SMA48CAT3G | SXC            | 48                                    | 2.5                                     | 53.3                             | 56.11 | 58.91 | 1.0              | 77.4   | 5.2             | 135                      |
| 1SMA58CAT3G | TGC            | 58                                    | 2.5                                     | 64.4                             | 67.79 | 71.18 | 1.0              | 93.6   | 4.3             | 115                      |
| 1SMA60CAT3G | TKC            | 60                                    | 2.5                                     | 66.7                             | 70.21 | 73.72 | 1.0              | 96.8   | 4.1             | 110                      |
| 1SMA70CAT3G | TPC            | 70                                    | 2.5                                     | 77.8                             | 81.90 | 85.99 | 1.0              | 113  | 3.5             | 95                       |
| 1SMA78CAT3G | TTC            | 78                                    | 2.5                                     | 86.7                             | 91.27 | 95.83 | 1.0              | 126  | 3.2             | 90                       |

4. A transient suppressor is normally selected according to the working peak reverse voltage (V<sub>RWM</sub>), which should be equal to or greater than the DC or continuous peak operating voltage level

5. V<sub>BR</sub> measured at pulse test current I<sub>T</sub> at an ambient temperature of 25°C

6. Surge current waveform per Figure 2 and derate per Figure 3

7. Bias voltage = 0 V, F = 1.0 MHz, T<sub>J</sub> = 25°C.

†Please see 1SMA5.0AT3 to 1SMA78AT3 for Unidirectional devices.

\* Include SZ-prefix devices where applicable.

# 1SMA10CAT3G Series, SZ1SMA10CAT3G Series

## RATING AND TYPICAL CHARACTERISTIC CURVES

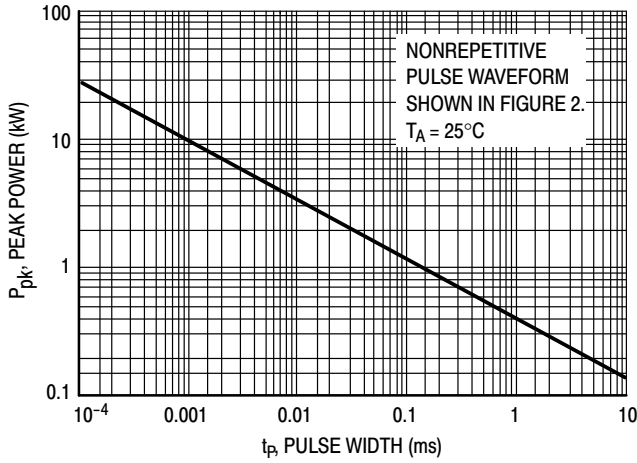

Figure 1. Pulse Rating Curve

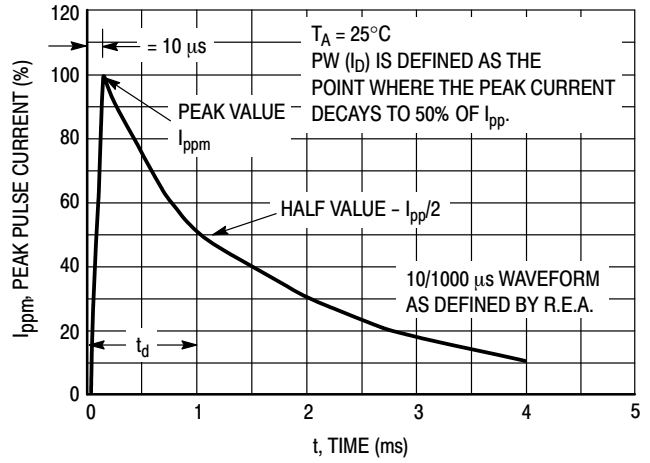

Figure 2. Pulse Waveform

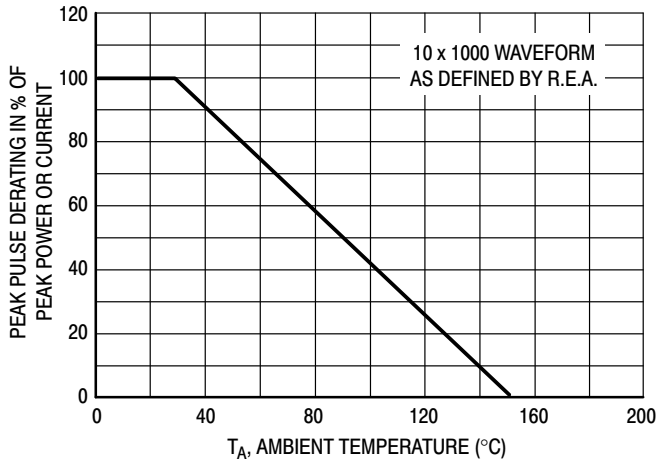

Figure 3. Pulse Derating Curve

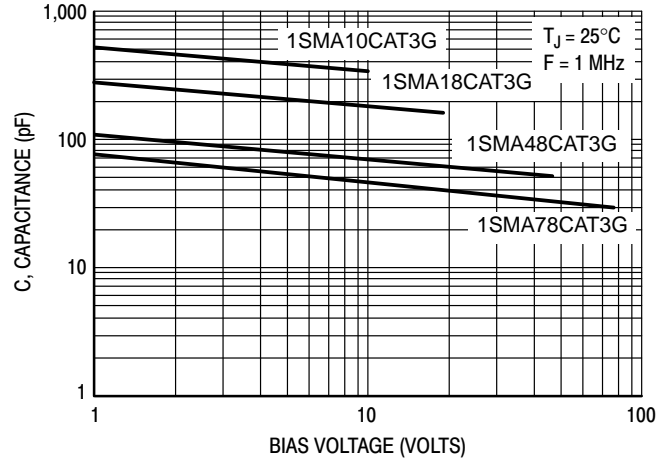
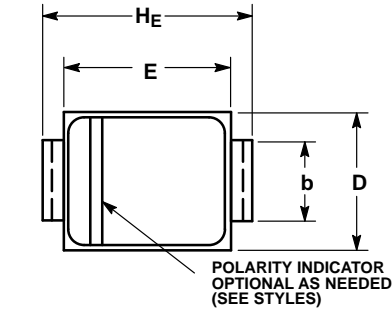

Figure 4. Typical Junction Capacitance vs. Bias Voltage

# 1SMA10CAT3G Series, SZ1SMA10CAT3G Series

## PACKAGE DIMENSIONS

### SMA CASE 403D ISSUE H



NOTES:

1. DIMENSIONING AND TOLERANCING PER ANSI Y14.5M, 1982.
2. CONTROLLING DIMENSION: INCH.
3. DIMENSION b SHALL BE MEASURED WITHIN DIMENSION L.

| DIM | MILLIMETERS |      |      | INCHES |       |       |
|-----|-------------|------|------|--------|-------|-------|
|     | MIN         | NOM  | MAX  | MIN    | NOM   | MAX   |
| A   | 1.97        | 2.10 | 2.20 | 0.078  | 0.083 | 0.087 |
| A1  | 0.05        | 0.10 | 0.20 | 0.002  | 0.004 | 0.008 |
| b   | 1.27        | 1.45 | 1.63 | 0.050  | 0.057 | 0.064 |
| c   | 0.15        | 0.28 | 0.41 | 0.006  | 0.011 | 0.016 |
| D   | 2.29        | 2.60 | 2.92 | 0.090  | 0.103 | 0.115 |
| E   | 4.06        | 4.32 | 4.57 | 0.160  | 0.170 | 0.180 |
| HE  | 4.83        | 5.21 | 5.59 | 0.190  | 0.205 | 0.220 |
| L   | 0.76        | 1.14 | 1.52 | 0.030  | 0.045 | 0.060 |

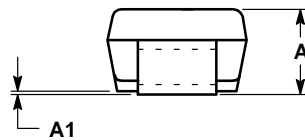
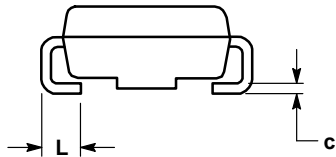

### SOLDERING FOOTPRINT\*

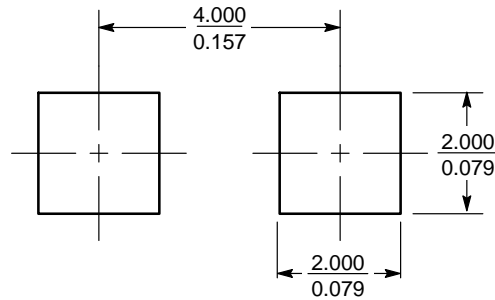

SCALE 8:1  $\left(\frac{\text{mm}}{\text{inches}}\right)$

\*For additional information on our Pb-Free strategy and soldering details, please download the ON Semiconductor Soldering and Mounting Techniques Reference Manual, SOLDERRM/D.

SURMETIC is a registered trademark of Semiconductor Components Industries, LLC.

ON Semiconductor and are registered trademarks of Semiconductor Components Industries, LLC (SCILLC). SCILLC reserves the right to make changes without further notice to any products herein. SCILLC makes no warranty, representation or guarantee regarding the suitability of its products for any particular purpose, nor does SCILLC assume any liability arising out of the application or use of any product or circuit, and specifically disclaims any and all liability, including without limitation special, consequential or incidental damages. "Typical" parameters which may be provided in SCILLC data sheets and/or specifications can and do vary in different applications and actual performance may vary over time. All operating parameters, including "Typicals" must be validated for each customer application by customer's technical experts. SCILLC does not convey any license under its patent rights nor the rights of others. SCILLC products are not designed, intended, or authorized for use as components in systems intended for surgical implant into the body, or other applications intended to support or sustain life, or for any other application in which the failure of the SCILLC product could create a situation where personal injury or death may occur. Should Buyer purchase or use SCILLC products for any such unintended or unauthorized application, Buyer shall indemnify and hold SCILLC and its officers, employees, subsidiaries, affiliates, and distributors harmless against all claims, costs, damages, and expenses, and reasonable attorney fees arising out of, directly or indirectly, any claim of personal injury or death associated with such unintended or unauthorized use, even if such claim alleges that SCILLC was negligent regarding the design or manufacture of the part. SCILLC is an Equal Opportunity/Affirmative Action Employer. This literature is subject to all applicable copyright laws and is not for resale in any manner.

### PUBLICATION ORDERING INFORMATION



**LITERATURE FULFILLMENT:**  
Literature Distribution Center for ON Semiconductor  
P.O. Box 5163, Denver, Colorado 80217 USA  
**Phone:** 303-675-2175 or 800-344-3860 Toll Free USA/Canada  
**Fax:** 303-675-2176 or 800-344-3867 Toll Free USA/Canada  
**Email:** orderlit@onsemi.com

**N. American Technical Support:** 800-282-9855 Toll Free  
USA/Canada  
**Europe, Middle East and Africa Technical Support:**  
Phone: 421 33 790 2910  
**Japan Customer Focus Center**  
Phone: 81-3-5817-1050

**ON Semiconductor Website:** [www.onsemi.com](http://www.onsemi.com)  
**Order Literature:** <http://www.onsemi.com/orderlit>  
For additional information, please contact your local  
Sales Representative

## Looking for pricing, stock, or lifecycle information?

Click below to explore more details on WIN SOURCE:

-  [View 1SMA36CAT3G on WIN SOURCE](#)
-  [Littelfuse Inc. Information](#)

## Optimize Your Supply Chain with WIN SOURCE Solutions

-  Global Sourcing Solution
-  Obsolete Management
-  Cost Control Management
-  Shortage Management
-  Alternative Solution
-  Excess Inventory Management