



**THE DATASHEET OF  
IR21364SPBF**



## IR21364(S&J)PBF 3-PHASE BRIDGE DRIVER

### Features

- Floating channel designed for bootstrap operation
- Tolerant to negative transient voltage – dV/dt immune
- Gate drive supply range from 11.5 V to 20 V
- Undervoltage lockout for all channels
- Over-current shutdown turns off all six drivers
- Independent 3 half-bridge drivers
- Matched propagation delay for all channels
- Cross-conduction prevention logic
- Low side and High side outputs in phase with inputs.
- 3.3 V logic compatible
- Lower di/dt gate drive for better noise immunity
- Externally programmable delay for automatic fault clear
- RoHS Compliant

### Product Summary

|  |                       |
|--|-----------------------|
| Topology                                       | 3 phase bridge driver |
| $V_{\text{OFFSET}}$                            | $\leq 600 \text{ V}$  |
| $V_{\text{OUT}}$                               | 11.5 V – 20V          |
| $I_{\text{O+}} \& I_{\text{O-}}$<br>(typical)  | 200 mA & 350 mA       |
| $t_{\text{ON}} \& t_{\text{OFF}}$<br>(typical) | 500 ns & 530 ns       |

### Typical Applications

- Motor Control
- Air Conditioners/ Washing Machines
- General Purpose Inverters
- Micro/Mini Inverter Drives

### Package Options

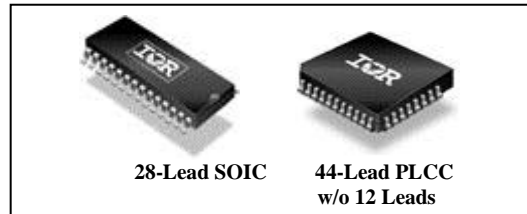

### Typical Connection

(Refer to Lead Assignments for correct pin configuration). This/These diagram(s) show electrical connections only. Please refer to our Application Notes and DesignTips for proper circuit board layout.

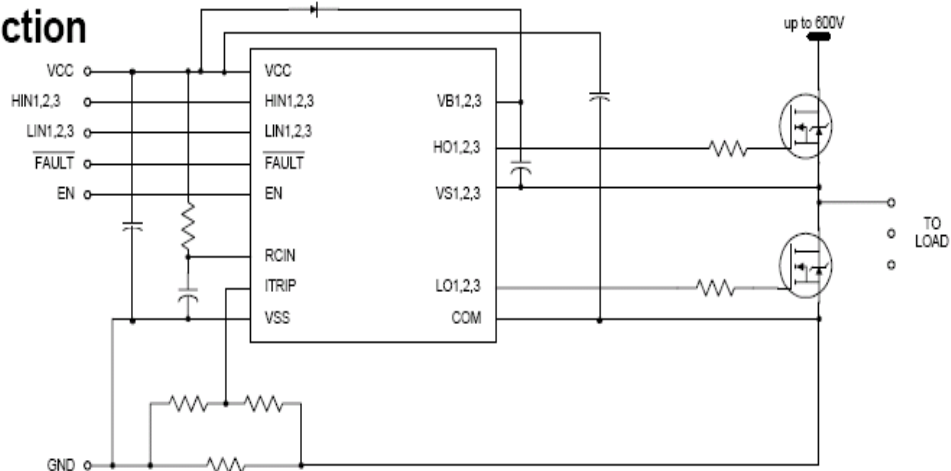

**Description**

The IR21364(S&J)PBF is a high voltage, high speed power MOSFET and IGBT drivers with three independent high and low side referenced output channels for 3-phase applications. Proprietary HVIC technology enables ruggedized monolithic construction. Logic inputs are compatible with CMOS or LSTTL outputs, down to 3.3V logic. A current trip function which terminates all six outputs can be derived from an external current sense resistor. An enable function is available to terminate all six outputs simultaneously. An open-drain FAULT signal is provided to indicate that an overcurrent or undervoltage shutdown has occurred. Overcurrent fault conditions are cleared automatically after a delay programmed externally via an RC network connected to the RCIN input. The output drivers feature a high pulse current buffer stage designed for minimum driver cross-conduction. Propagation delays are matched to simplify use in high frequency applications. The floating channel can be used to drive N-channel power MOSFETs or IGBTs in the high side configuration which operates up to 600 V.

**Qualification Information<sup>†</sup>**

|                                   |                  |   |  |
|-----------------------------------|------------------|---|--|
| <b>Qualification Level</b>        |                  | Industrial <sup>††</sup>  |  |
|                                   |                  | Comments: This family of ICs has passed JEDEC's Industrial qualification. IR's Consumer qualification level is granted by extension of the higher Industrial level. |  |
| <b>Moisture Sensitivity Level</b> |                  | SOIC28W   | MSL3 <sup>†††</sup> , 260°C<br>(per IPC/JEDEC J-STD-020) |
|                                   |                  | PLCC44  | MSL3 <sup>†††</sup> , 245°C<br>(per IPC/JEDEC J-STD-020) |
| <b>ESD</b>                        | Human Body Model | Class 2<br>(per JEDEC standard JESD22-A114)   |  |
|                                   | Machine Model    | Class B<br>(per EIA/JEDEC standard EIA/JESD22-A115)   |  |
| <b>IC Latch-Up Test</b>           |                  | Class I, Level A<br>(per JESD78)  |  |
| <b>RoHS Compliant</b>             |                  | Yes   |  |

† Qualification standards can be found at International Rectifier's web site <http://www.irf.com/>

†† Higher qualification ratings may be available should the user have such requirements. Please contact your International Rectifier sales representative for further information.

††† Higher MSL ratings may be available for the specific package types listed here. Please contact your International Rectifier sales representative for further information.

### Absolute Maximum Ratings

Absolute Maximum Ratings indicate sustained limits beyond which damage to the device may occur. All voltage parameters are absolute voltages referenced to COM. The thermal resistance and power dissipation ratings are measured under board mounted and still air conditions.

| Symbol               | Definition   |                | Min                       | Max  | Units |
|----------------------|--|----------------|---------------------------|--|-------|
| V <sub>S</sub>       | High side offset voltage                               |                | V <sub>B 1,2,3</sub> - 25 | V <sub>B 1,2,3</sub> + 0.3                                   | V     |
| V <sub>B</sub>       | High side floating supply voltage                      |                | -0.3                      | 625  |       |
| V <sub>HO</sub>      | High side floating output voltage                      |                | V <sub>S1,2,3</sub> - 0.3 | V <sub>B 1,2,3</sub> + 0.3                                   |       |
| V <sub>CC</sub>      | Low side and logic fixed supply voltage                |                | -0.3                      | 25   |       |
| V <sub>SS</sub>      | Logic ground   |                | V <sub>CC</sub> - 25      | V <sub>CC</sub> + 0.3  |       |
| V <sub>LO1,2,3</sub> | Low side output voltage                                |                | -0.3                      | V <sub>CC</sub> + 0.3  |       |
| V <sub>IN</sub>      | Input voltage LIN, HIN, ITRIP, EN, RCIN                |                | V <sub>SS</sub> - 0.3     | lower of<br>V <sub>CC</sub> + 0.3 or<br>V <sub>SS</sub> + 15 |       |
| V <sub>FLT</sub>     | FAULT output voltage                                   |                | V <sub>SS</sub> - 0.3     | V <sub>CC</sub> + 0.3  |       |
| dV/dt                | Allowable offset voltage slew rate                     |                | —                         | 50   | V/ns  |
| P <sub>D</sub>       | Package power dissipation<br>@ T <sub>A</sub> ≤ +25 °C | (28 lead SOIC) | —                         | 1.6  | W     |
|                      |  | (44 lead PLCC) | —                         | 2.0  |       |
| R <sub>thJA</sub>    | Thermal resistance, junction to ambient                | (28 lead SOIC) | —                         | 78   | °C/W  |
|                      |  | (44 lead PLCC) | —                         | 63   |       |
| T <sub>J</sub>       | Junction temperature                                   |                | —                         | 150  | °C    |
| T <sub>S</sub>       | Storage temperature                                    |                | -55                       | 150  |       |
| T <sub>L</sub>       | Lead temperature (soldering, 10 seconds)               |                | —                         | 300  |       |

### Recommended Operating Conditions

The input/output logic timing diagram is shown in Fig. 1. For proper operation the device should be used within the recommended conditions. All voltage parameters are absolute referenced to COM. The V<sub>S</sub> & V<sub>SS</sub> offset rating are tested with all supplies biased at a 15 V differential.

| Symbol                | Definition                        |         | Min.                       | Max.                     | Units |
|-----------------------|-----------------------------------|---------|----------------------------|--------------------------|-------|
| V <sub>B1,2,3</sub>   | High side floating supply voltage | IR21364 | V <sub>S1,2,3</sub> + 11.5 | V <sub>S1,2,3</sub> + 20 | V     |
| V <sub>S 1,2,3</sub>  | High side floating supply voltage |         | Note 1                     | 600                      |       |
| V <sub>CC</sub>       | Low side supply voltage           | IR21364 | 11.5                       | 20                       |       |
| V <sub>HO 1,2,3</sub> | High side output voltage          |         | V <sub>S1,2,3</sub>        | V <sub>B1,2,3</sub>      |       |
| V <sub>LO1,2,3</sub>  | Low side output voltage           |         | 0                          | V <sub>CC</sub>          |       |
| V <sub>SS</sub>       | Logic ground                      |         | -5                         | 5                        |       |
| V <sub>FLT</sub>      | FAULT output voltage              |         | V <sub>SS</sub>            | V <sub>CC</sub>          |       |
| V <sub>RCIN</sub>     | RCIN input voltage                |         | V <sub>SS</sub>            | V <sub>CC</sub>          |       |
| V <sub>ITRIP</sub>    | ITRIP input voltage               |         | V <sub>SS</sub>            | V <sub>SS</sub> + 5      |       |
| V <sub>IN</sub>       | Logic input voltage LIN, HIN, EN  |         | V <sub>SS</sub>            | V <sub>SS</sub> + 5      |       |
| T <sub>A</sub>        | Ambient temperature               |         | -40                        | 125                      | °C    |

**Note 1:** Logic operational for V<sub>S</sub> of COM -5 V to COM + 600 V. Logic state held for V<sub>S</sub> of COM -5 to COM - V<sub>BS</sub>.  
(Please refer to the Design Tip DT97 -3 for more details).

### Static Electrical Characteristics

$V_{BIAS}$  ( $V_{CC}$ ,  $V_{BS\ 1,2,3}$ ) = 15 V,  $T_A = 25^\circ\text{C}$  unless otherwise specified. The  $V_{IN}$ ,  $V_{TH}$  and  $I_{IN}$  parameters are referenced to  $V_{SS}$  and are applicable to all six channels (HIN1,2,3 and LIN1,2,3). The  $V_O$  and  $I_O$  parameters are referenced to COM and  $V_{S1,2,3}$  and are applicable to the respective output leads: HO1,2,3 and LO1,2,3.

| Symbol          | Definition  | Min     | Typ  | Max  | Units  | Test Conditions                          |   |                      |
|-----------------|---|---------|------|------|--|--|---|----------------------|
| $V_{IH}$        | Logic "0" input voltage                               | —       | —    | 0.8  | V  |  |   |                      |
| $V_{IL}$        | Logic "1" input voltage                               | 2.5     | —    | —    |  |  |   |                      |
| $V_{EN,TH+}$    | Enable positive going threshold                       | —       | —    | 2.5  |  |  |   |                      |
| $V_{EN,TH-}$    | Enable negative going threshold                       | 0.8     | —    | —    |  |  |   |                      |
| $V_{IT,TH+}$    | ITRIP positive going threshold                        | 0.37    | 0.46 | 0.55 |  |  |   |                      |
| $V_{IT,HYS}$    | ITRIP hysteresis                                      | —       | 0.07 | —    |  |  |   |                      |
| $V_{RCIN,TH+}$  | RCIN positive going threshold                         | —       | 8    | —    |  |  |   |                      |
| $V_{RCIN,HYS}$  | RCIN hysteresis                                       | —       | 3    | —    |  |  |   |                      |
| $V_{OH}$        | High level output voltage, $V_{BIAS} - V_O$           | —       | 0.9  | 1.4  |  |  | V   | $I_O = 20\text{ mA}$ |
| $V_{OL}$        | Low level output voltage, $V_O$                       | —       | 0.4  | 0.6  |  |  |   |                      |
| $V_{CCUV+}$     | $V_{CC}$ supply undervoltage positive going threshold | IR21364 | 9.6  | 10.4 |  |  | 11.2  |                      |
| $V_{CCUV-}$     | $V_{CC}$ supply undervoltage negative going threshold | IR21364 | 8.6  | 9.4  |  |  | 10.2  |                      |
| $V_{CCUVHY}$    | $V_{CC}$ supply undervoltage hysteresis               | IR21364 | —    | 1    |  |  | —   |                      |
| $V_{BSUV+}$     | $V_{BS}$ supply undervoltage positive going threshold | IR21364 | 9.6  | 10.4 |  |  | 11.2  |                      |
| $V_{BSUV-}$     | $V_{BS}$ supply undervoltage negative going threshold | IR21364 | 8.6  | 9.4  |  |  | 10.2  |                      |
| $V_{BSUVHY}$    | $V_{BS}$ supply undervoltage hysteresis               | IR21364 | —    | 1    |  |  | —   |                      |
| $I_{lk}$        | Offset supply leakage current                         | —       | —    | 50   | $\mu\text{A}$                                      | $V_B = V_S = 600\text{ V}$               |   |                      |
| $I_{QBS}$       | Quiescent $V_{BS}$ supply current                     | —       | 70   | 120  |  | $V_{B1,2,3} = V_{S1,2,3} = 600\text{ V}$ |   |                      |
| $I_{QCC}$       | Quiescent $V_{CC}$ supply current                     | —       | 0.6  | 1.3  | mA   | $V_{IN} = 0\text{ V or } 5\text{ V}$     |   |                      |
| $I_{LIN+}$      | Input bias current (LOUT = HI)                        | —       | 100  | 195  | $\mu\text{A}$                                      | $V_{LIN} = 3.3\text{ V}$                 |   |                      |
| $I_{LIN-}$      | Input bias current (LOUT = LO)                        | -1      | —    | —    |  | $V_{LIN} = 0\text{ V}$                   |   |                      |
| $I_{HIN+}$      | Input bias current (HOUT = HI)                        | —       | 100  | 195  |  | $V_{HIN} = 3.3\text{ V}$                 |   |                      |
| $I_{HIN-}$      | Input bias current (HOUT = LO)                        | -1      | —    | —    |  | $V_{HIN} = 0\text{ V}$                   |   |                      |
| $I_{ITRIP+}$    | "High" ITRIP input bias current                       | —       | 3.3  | 6    |  | $V_{ITRIP} = 3.3\text{ V}$               |   |                      |
| $I_{ITRIP-}$    | "Low" ITRIP input bias current                        | -1      | —    | —    |  | $V_{ITRIP} = 0\text{ V}$                 |   |                      |
| $I_{EN+}$       | "High" ENABLE input bias current                      | —       | 100  | —    |  | $V_{EN} = 3.3\text{ V}$                  |   |                      |
| $I_{EN-}$       | "Low" ENABLE input bias current                       | -1      | —    | —    |  | $V_{EN} = 0\text{ V}$                    |   |                      |
| $I_{RCIN}$      | RCIN input bias current                               | —       | —    | 1    |  | $V_{rcin} = 0\text{ V or } 15\text{ V}$  |   |                      |
| $I_{O+}$        | Output high short circuit pulsed current              | 120     | 200  | —    |  | mA                                       | $V_O = 0\text{ V}$ ,<br>$PW \leq 10\ \mu\text{s}$ |                      |
| $I_{O-}$        | Output low short circuit pulsed current               | 250     | 350  | —    | $V_O = 15\text{ V}$ ,<br>$PW \leq 10\ \mu\text{s}$ |  |   |                      |
| $R_{on\_RCIN}$  | RCIN low on resistance                                | —       | 50   | 100  | $\Omega$   | $I = 1.5\text{ mA}$                      |   |                      |
| $R_{on\_FAULT}$ | FAULT low on resistance                               | —       | 50   | 100  |  |  |   |                      |

**Dynamic Electrical Characteristics**

Dynamic Electrical Characteristics  $V_{CC} = V_{BS} = V_{BIAS} = 15\text{ V}$ ,  $V_{S1,2,3} = V_{SS} = \text{COM}$ ,  $T_A = 25^\circ\text{C}$  and  $C_L = 1000\text{ pF}$  unless otherwise specified.

| Symbol         | Definition   | Min | Typ  | Max  | Units                      | Test Conditions  |
|----------------|--|-----|------|------|----------------------------|--|
| $t_{on}$       | Turn-on propagation delay                          | 350 | 500  | 650  | ns                         | $V_{IN} = 0\text{ V} \& 5\text{ V}$                                      |
| $t_{off}$      | Turn-off propagation delay                         | 375 | 530  | 685  |                            |  |
| $t_r$          | Turn-on rise time                                  | —   | 125  | 190  |                            |  |
| $t_f$          | Turn-off fall time                                 | —   | 50   | 75   |                            |  |
| $t_{EN}$       | ENABLE low to output shutdown propagation delay    | 300 | 450  | 600  |                            | $V_{IN}, V_{EN} = 0\text{ V} \text{ or } 5\text{ V}$                     |
| $t_{ITRIP}$    | ITRIP to output shutdown propagation delay         | 500 | 750  | 1000 |                            | $V_{ITRIP} = 5\text{ V}$   |
| $t_{bl}$       | ITRIP blanking time                                | 100 | 150  | —    |                            | $V_{IN} = 0\text{ V} \text{ or } 5\text{ V}$<br>$V_{ITRIP} = 5\text{ V}$ |
| $t_{FLT}$      | ITRIP to FAULT propagation delay                   | 400 | 600  | 800  |                            |  |
| $t_{FILIN}$    | Input filter time (HIN, LIN)                       | 100 | 200  | —    |                            | $V_{IN} = 0\text{ V} \& 5\text{ V}$                                      |
| $t_{filterEn}$ | Enable input filter time                           | 100 | 200  | —    |                            |  |
| DT             | Deadtime   | 220 | 290  | 360  |                            | External dead time<br>>450 nsec  |
| MT             | Ton, off matching time (on all six channels)       | —   | —    | 75   |                            |  |
| MDT            | DT matching (Hi->Lo & Lo->Hi on all channels)      | —   | —    | 70   |                            |  |
| PM             | pulse width distortion (pwin-pwout)                | —   | —    | 75   | PW input =10 $\mu\text{s}$ |  |
| $t_{FLTCLR}$   | FAULT clear time RCIN: R = 2 M $\Omega$ , C = 1 nF | 1.3 | 1.65 | 2    | ms                         | $V_{IN} = 0\text{ V} \text{ or } 5\text{ V}$<br>$V_{ITRIP} = 0\text{ V}$ |

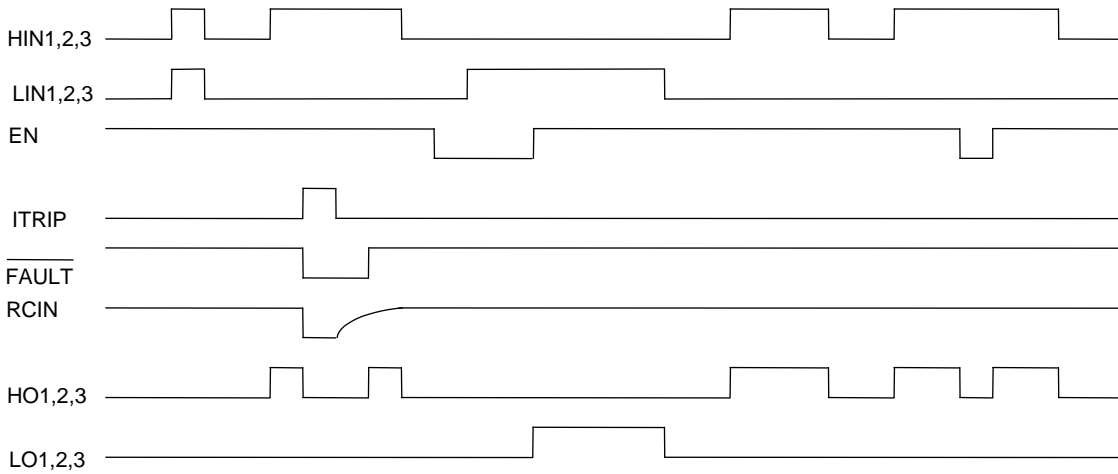

**Fig. 1. Input/Output Timing Diagram**

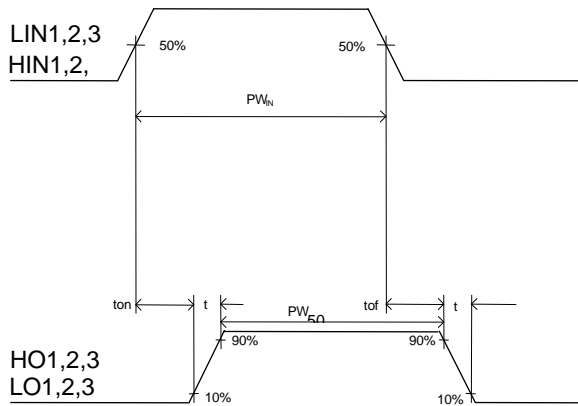

**Fig. 2. Switching Time Waveforms**

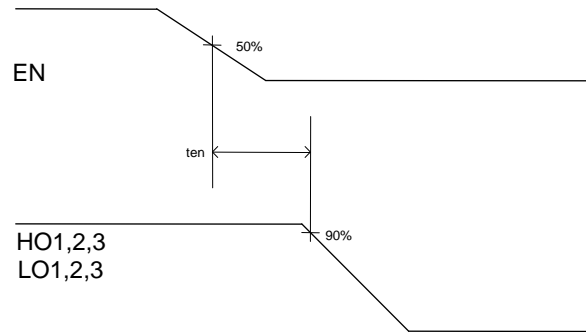

**Fig. 3. Output Enable Timing Waveform**

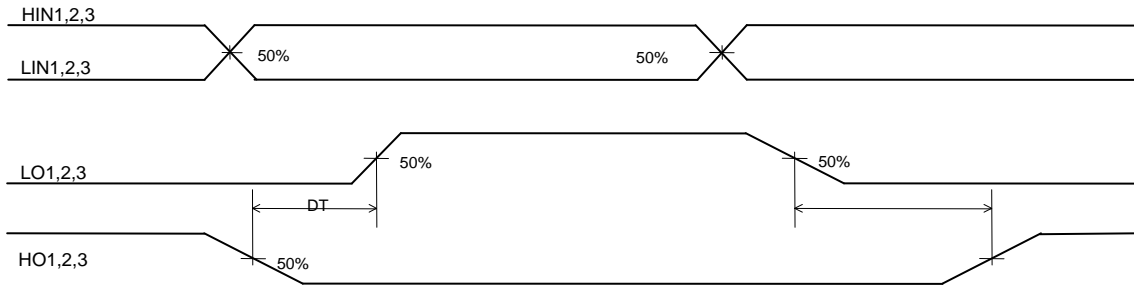

**Fig. 4. Internal Deadtime Timing Waveforms**

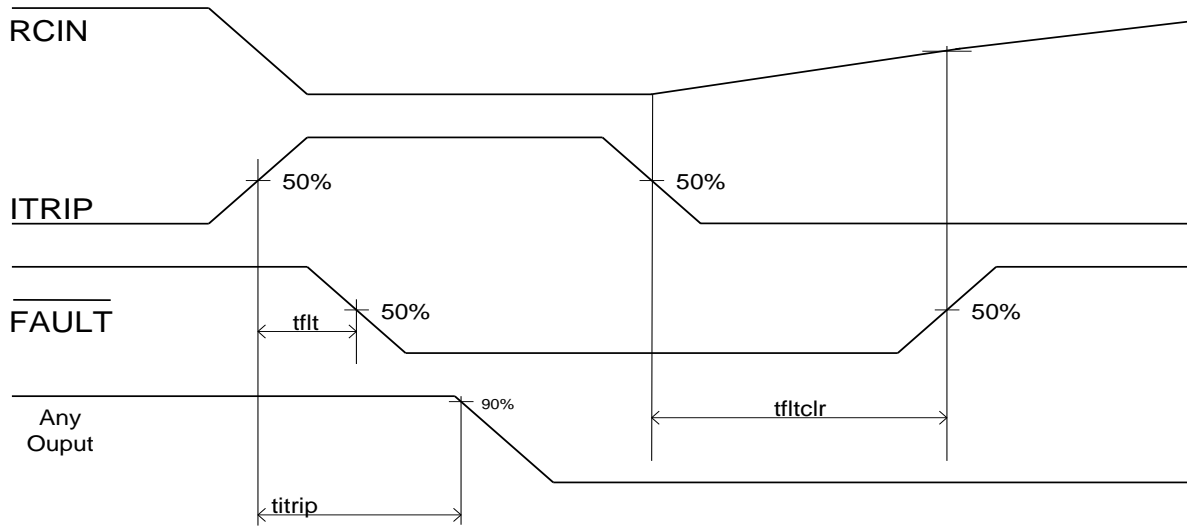

**Fig. 5. ITRIP/RCIN Timing Waveforms**

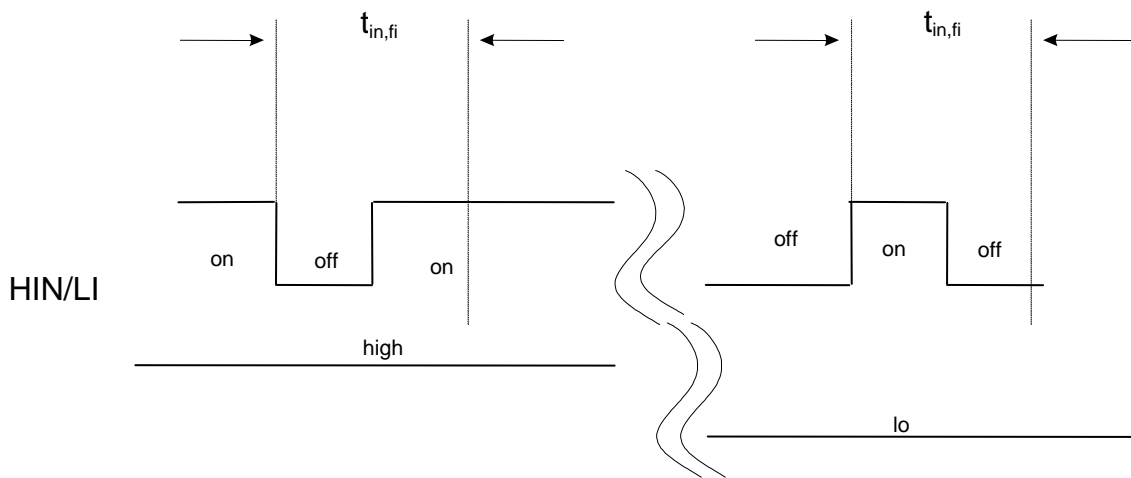

**Fig. 6. Input Filter Function**

**Lead Definitions**

| Symbol              | Description  |
|---------------------|--|
| V <sub>CC</sub>     | Low side supply voltage  |
| V <sub>SS</sub>     | Logic ground   |
| HIN1,2,3            | Logic inputs for high side gate driver outputs (HO1,2,3), in phase   |
| LIN1,2,3            | Logic input for low side gate driver outputs (LO1,2,3), in phase   |
| FAULT               | Indicates over-current (ITRIP) or low-side undervoltage lockout has occurred. Negative logic, open-drain output  |
| EN                  | Logic input to enable I/O functionality. Positive logic, i.e. I/O logic functions When ENABLE is high. No effect on FAULT and not latched  |
| ITRIP               | Analog input for overcurrent shutdown. When active, ITRIP shuts down outputs and activates FAULT and RCIN low. When ITRIP becomes inactive, FAULT stays active low for an externally set time T <sub>FLTCLR</sub> , then automatically becomes inactive (open-drain high impedance). |
| RCIN                | External RC network input used to define FAULT CLEAR delay, T <sub>FLTCLR</sub> , approximately equal to R*C. When RCIN > 8 V, the FAULT pin goes back into open-drain high-impedance  |
| COM                 | Low side gate drivers return   |
| V <sub>B1,2,3</sub> | High side floating supply  |
| HO1,2,3             | High side gate driver outputs  |
| V <sub>S1,2,3</sub> | High voltage floating supply return  |
| LO1,2,3             | Low side gate driver outputs   |

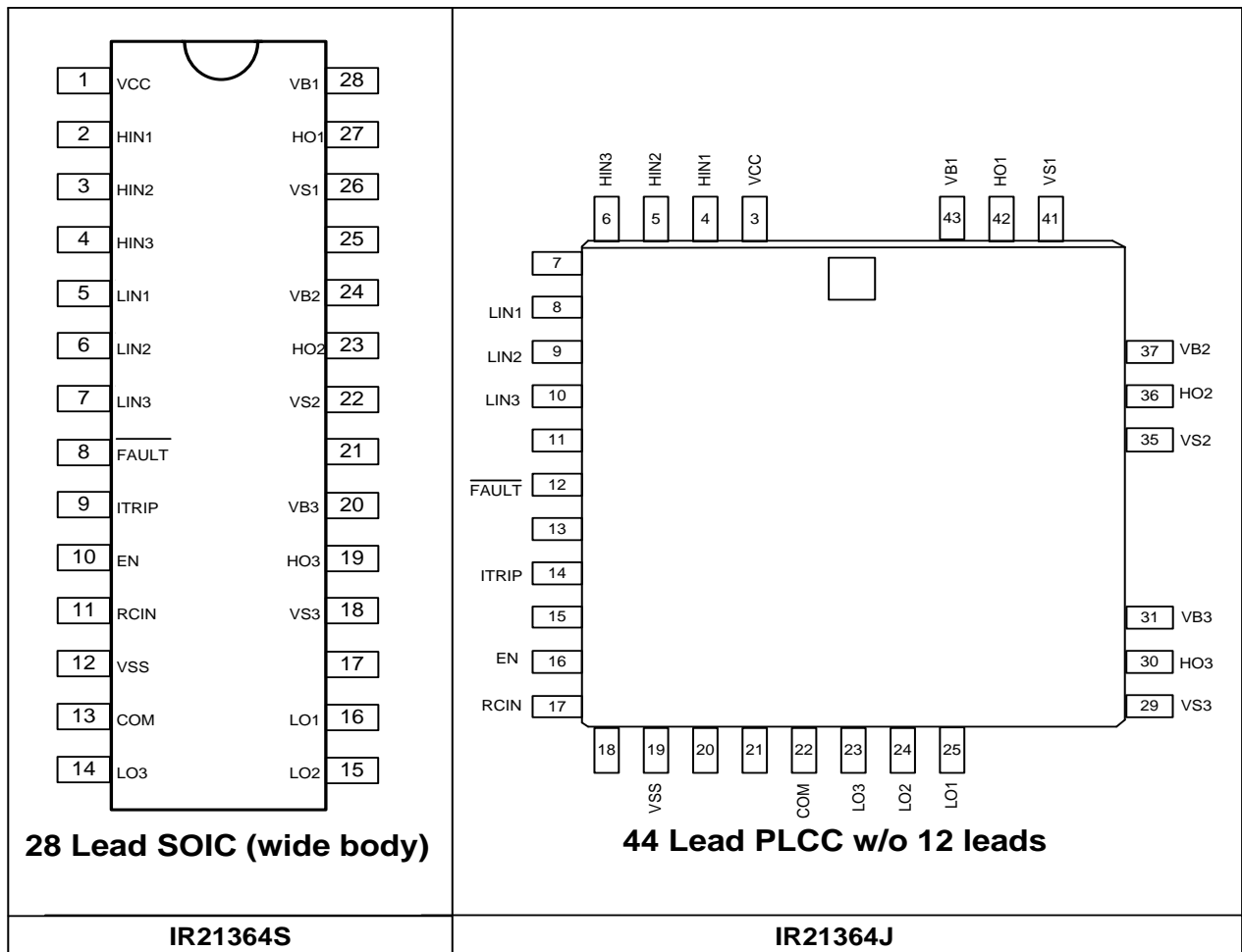

Functional Block Diagram

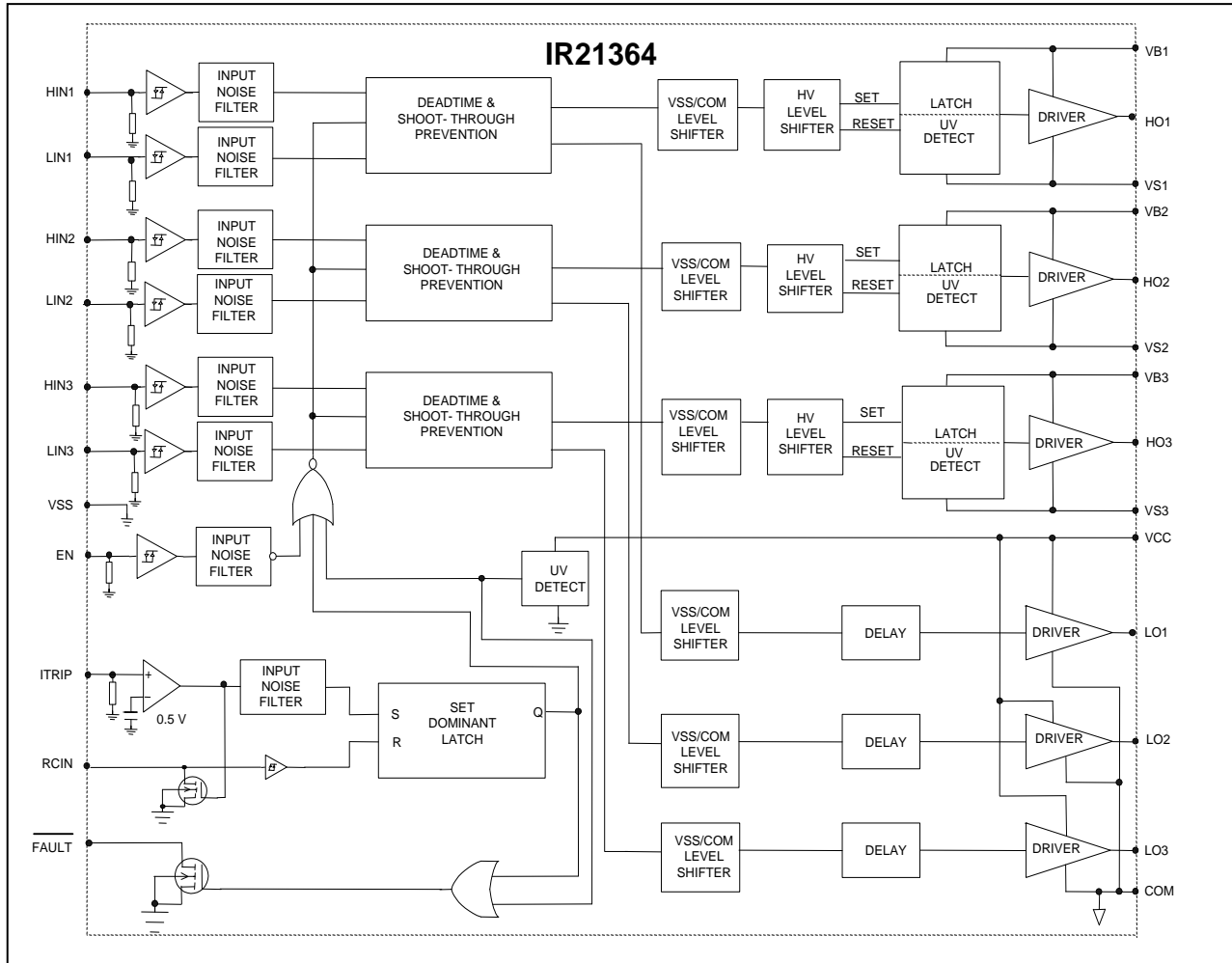

| VCC               | VBS               | ITRIP               | ENAB LE | FAULT      | LO1,2,3  | HO1,2,3  |
|-------------------|-------------------|---------------------|---------|------------|----------|----------|
| <U <sub>VCC</sub> | X                 | X                   | X       | 0 (note 1) | 0        | 0        |
| 15 V              | <U <sub>VBS</sub> | 0 V                 | 5 V     | high imp   | LIN1,2,3 | 0        |
| 15 V              | 15 V              | 0 V                 | 5 V     | high imp   | LIN1,2,3 | HIN1,2,3 |
| 15 V              | 15 V              | >V <sub>ITRIP</sub> | 5 V     | 0 (note 2) | 0        | 0        |
| 15 V              | 15 V              | 0 V                 | 0 V     | high imp   | 0        | 0        |

**Note 1:** A shoot-through prevention logic prevents LO1,2,3 and HO1,2,3 for each channel from turning on simultaneously.

**Note 2:** U<sub>VCC</sub> is not latched, when V<sub>CC</sub> > U<sub>VCC</sub>, FAULT return to high impedance.

**Note 3:** When ITRIP < V<sub>ITRIP</sub>, FAULT returns to high-impedance after RCIN pin becomes greater than 8 V (@ V<sub>CC</sub> = 15 V)

**Parameter Temperature Trends**

Figures 7-39 provide information on the experimental performance of the IR21364 HVIC. The line plotted in each figure is generated from actual lab data. A small number of individual samples were tested at three temperatures (-40 °C, 25 °C, and 125 °C) in order to generate the experimental (Exp.) curve. The line labeled Exp. consist of three data points (one data point at each of the tested temperatures) that have been connected together to illustrate the understood temperature trend. The individual data points on the curve were determined by calculating the averaged experimental value of the parameter (for a given temperature).

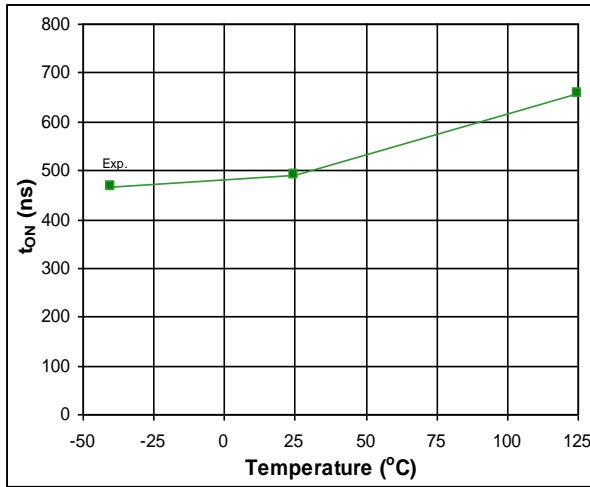

Fig. 7. (Ton\_Ls1 ) Turn-on Propagation Delay vs. Temperature

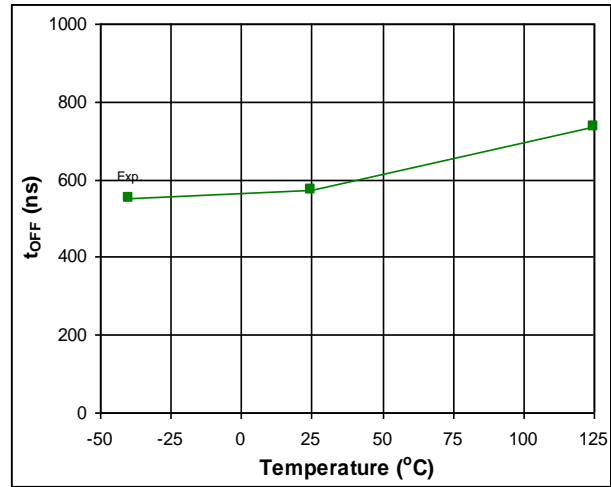

Fig. 8. (Toff\_Ls1) Turn-off Propagation Delay vs. Temperature

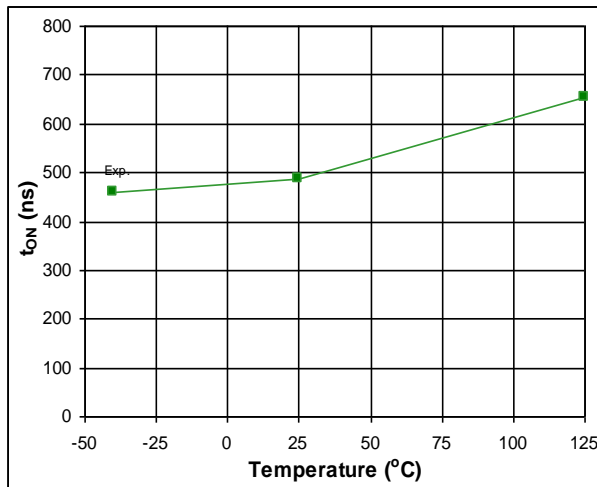

Fig. 9. (Ton\_Hs11) Turn-on Propagation Delay vs. Temperature

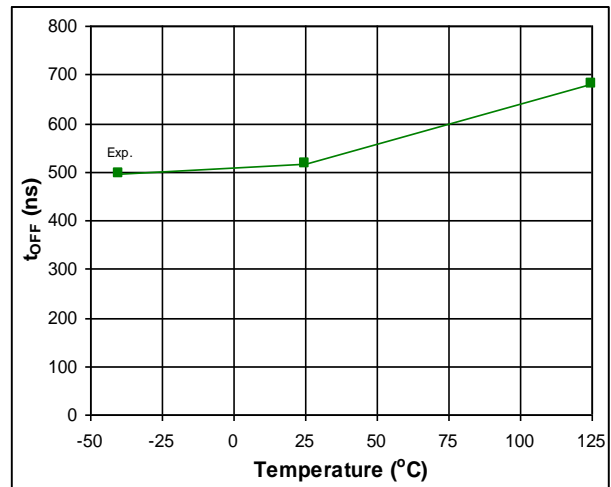

Fig. 10. (Toff\_Hs21) Turn-off Propagation Delay vs. Temperature

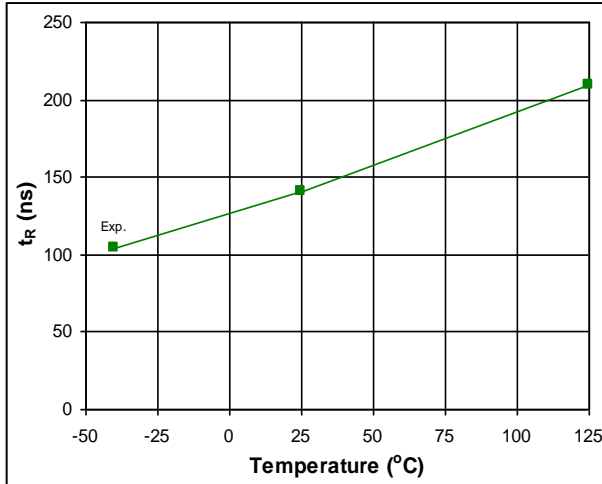

Fig. 11. Turn-on Rise Time vs. Temperature

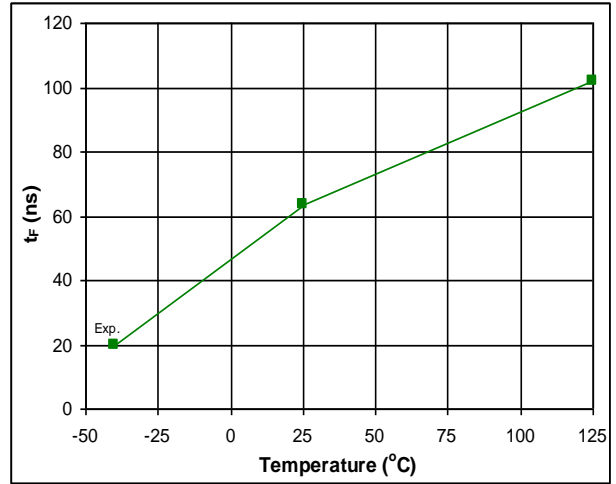

Fig. 12. Turn-off Fall Time vs. Temperature

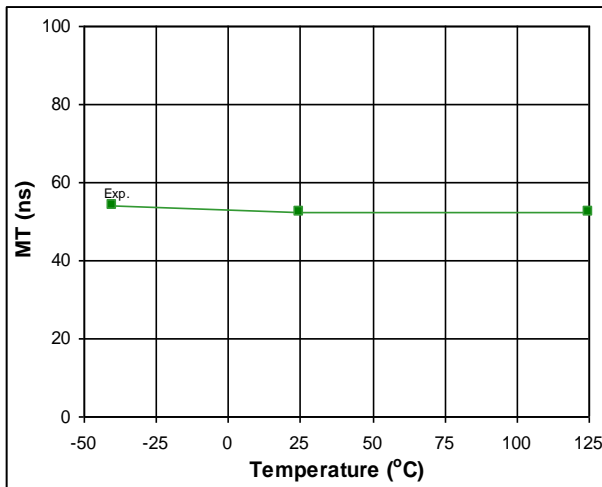

Fig. 13. Ton, off matching time vs. Temperature

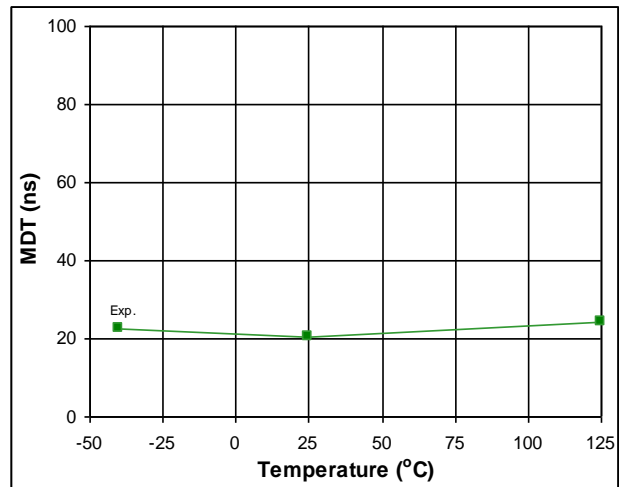

Fig. 14. DT matching time vs. Temperature

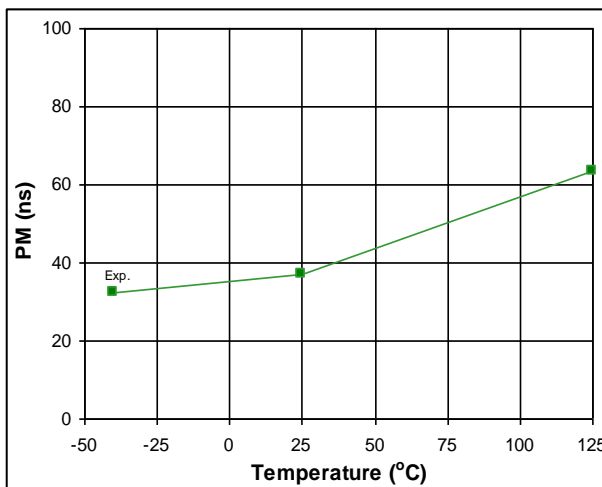

Fig. 15. Pulse Width Distortion vs. Temperature

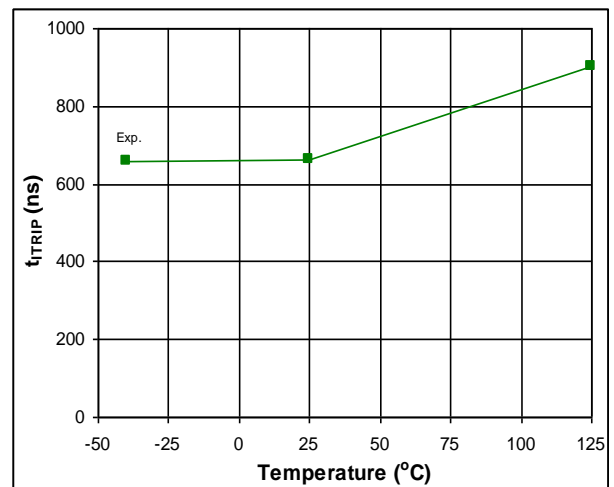

Fig. 16. ITRIP to Output Shutdown Propagation Delay vs. Temperature

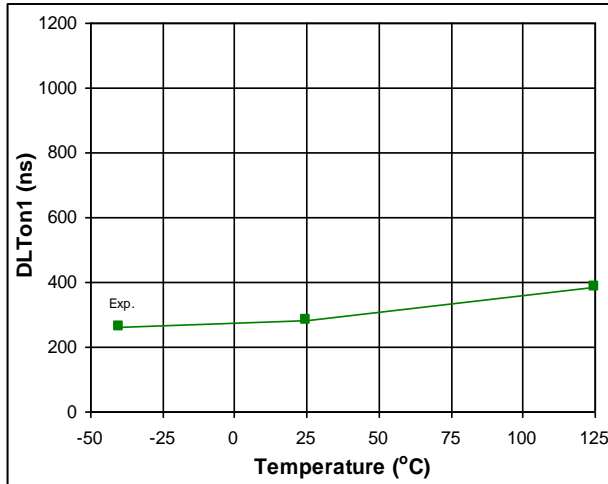

Fig. 17. Dead Time vs. Temperature

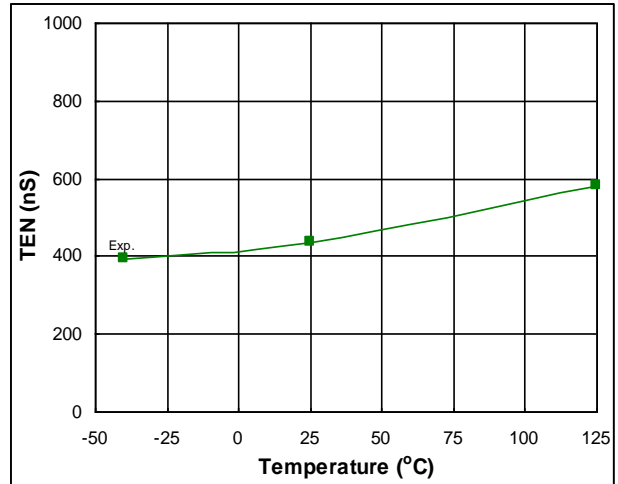

Figure 18. EN to Output Shutdown Time vs. Temperature

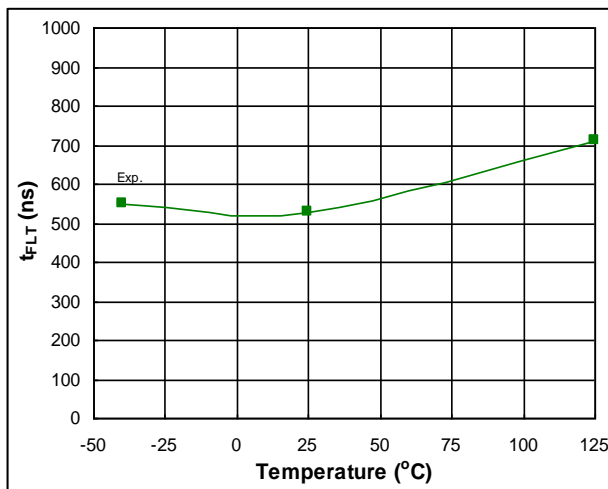

Fig. 19. ITRIP to FAULT Indication Delay vs. Temperature

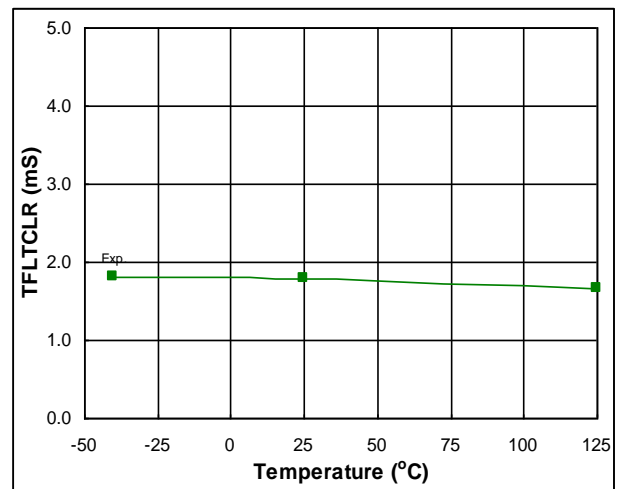

Fig. 20. FAULT Clear Time vs. Temperature

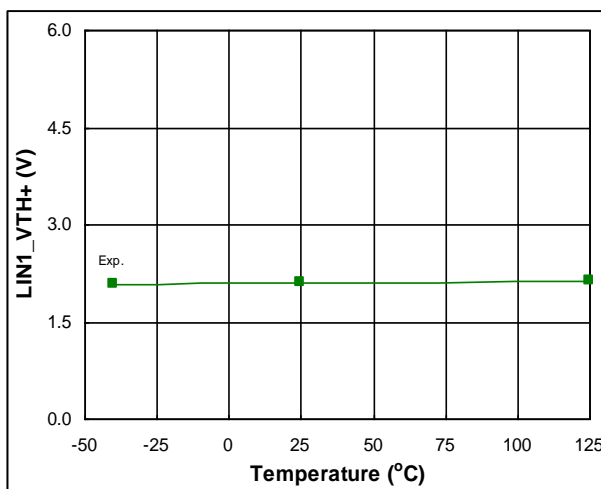

Fig. 21. Input Positive Going Threshold vs. Temperature

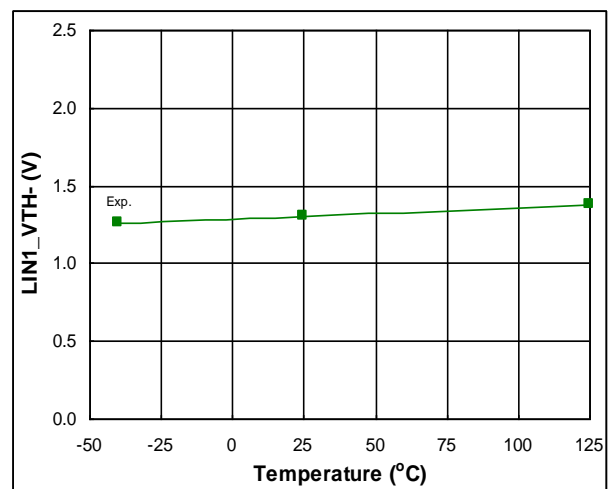

Fig. 22. Input Negative Going Threshold vs. Temperature

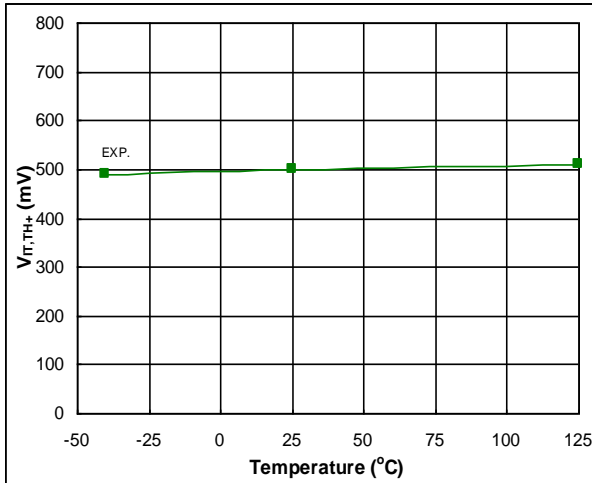

Fig. 23. ITRIP Input Positive Going Threshold vs. Temperature

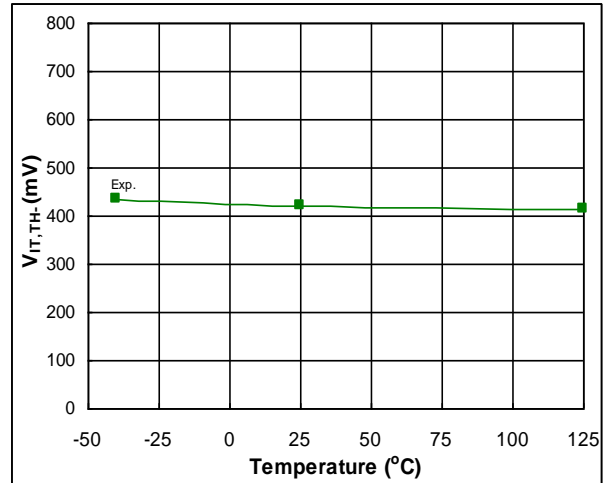

Fig. 24. ITRIP Input Negative Going Threshold vs. Temperature

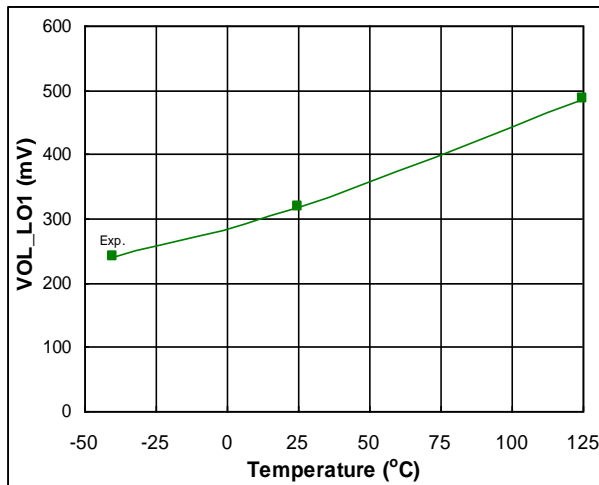

Fig. 25. Low Level Output Voltage vs. Temperature

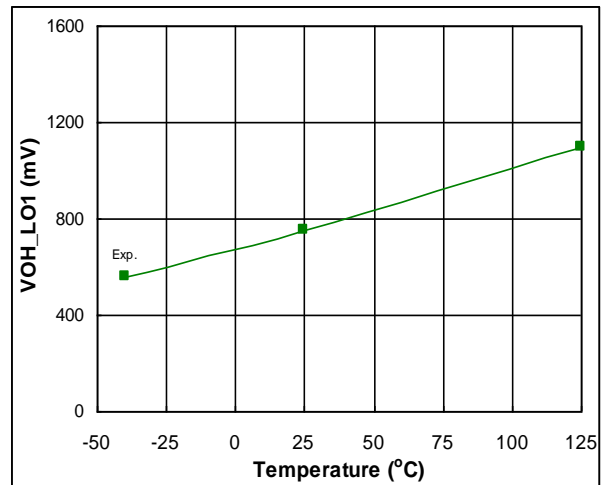

Fig. 26. High Level Output Voltage vs. Temperature

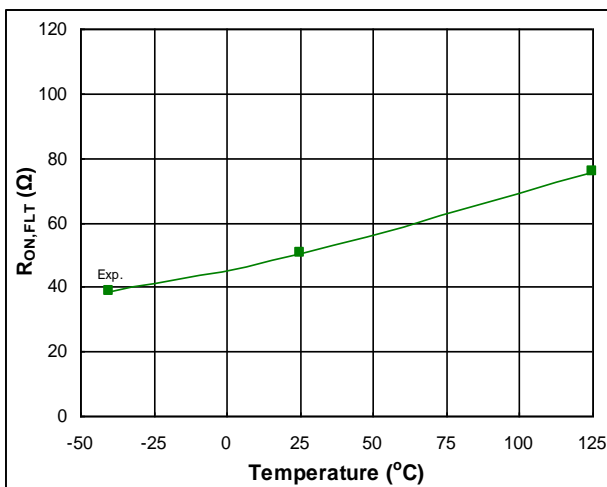

Fig. 27. FAULT Low On-Resistance vs. Temperature

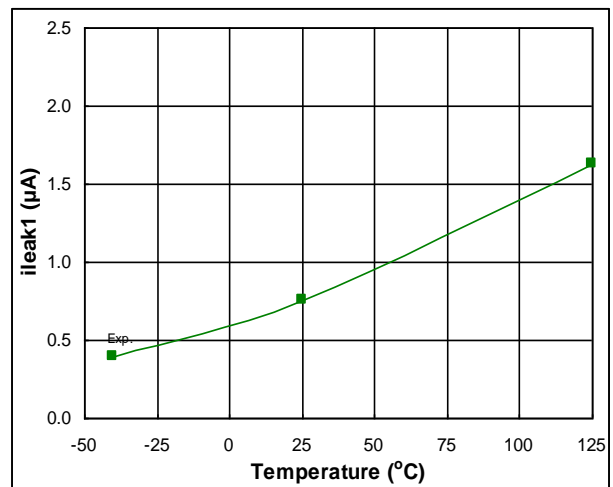

Fig. 28. Offset Supply Leakage Current vs. Temperature

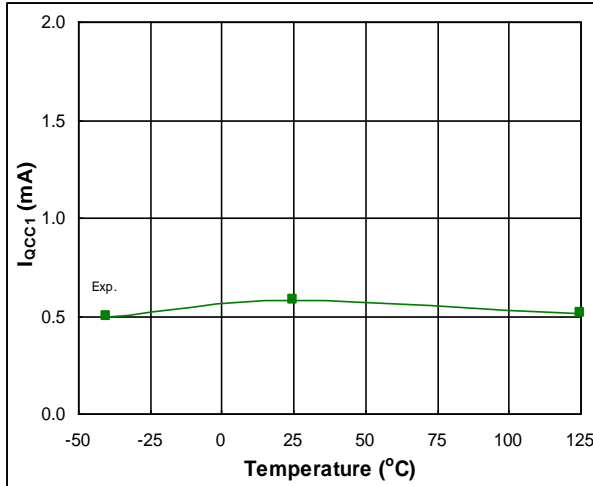

Fig. 29. Quiescent V<sub>CC</sub> Supply Current vs. Temperature

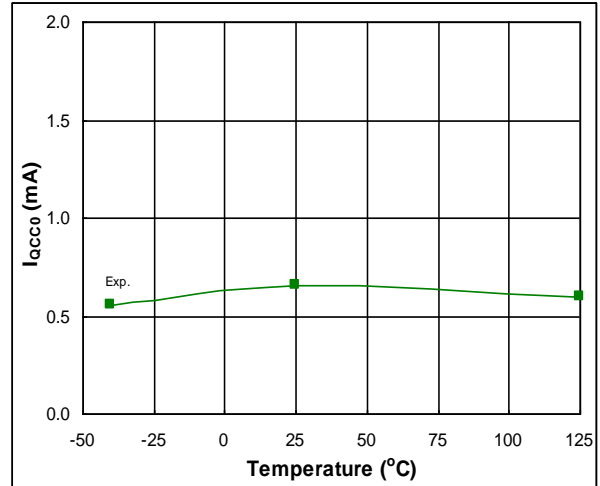

Fig. 30. Quiescent V<sub>CC</sub> Supply Current vs. Temperature

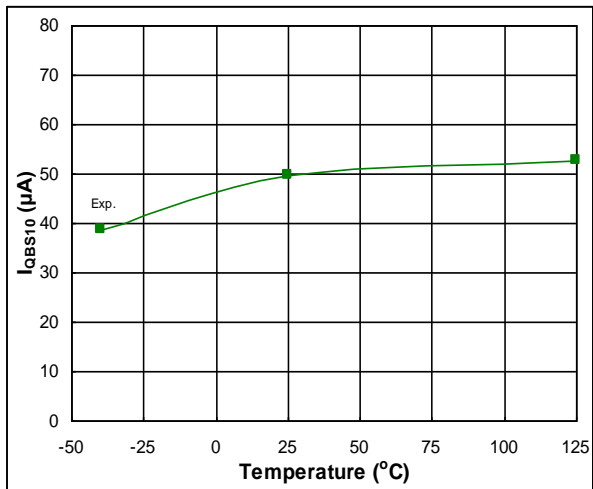

Fig. 31. Quiescent V<sub>BS</sub> Supply Current vs. Temperature

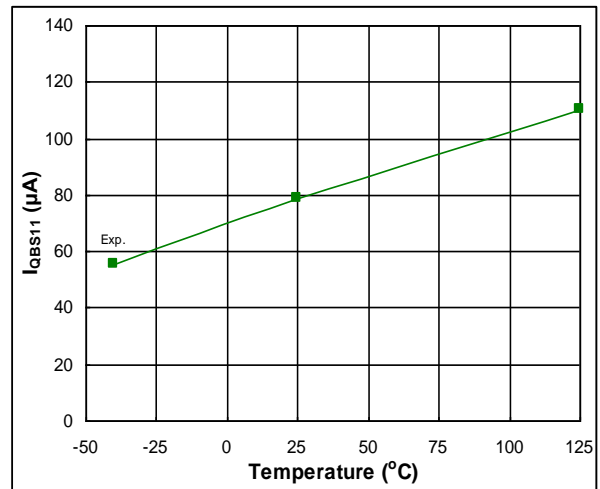

Fig. 32. Quiescent V<sub>BS</sub> Supply Current vs. Temperature

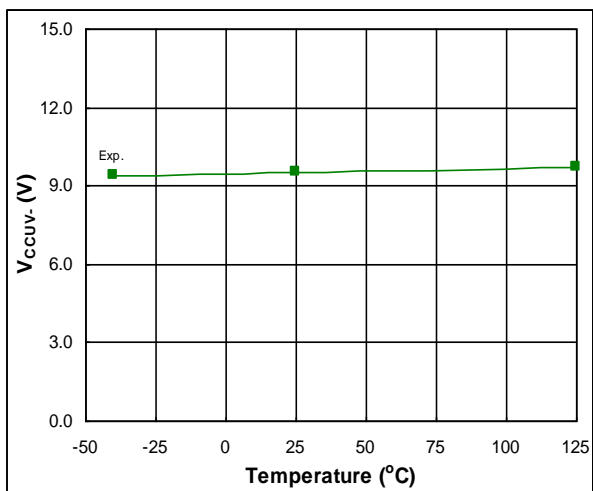

Fig. 33. V<sub>CC</sub> Supply Undervoltage Negative Going Threshold vs. Temperature

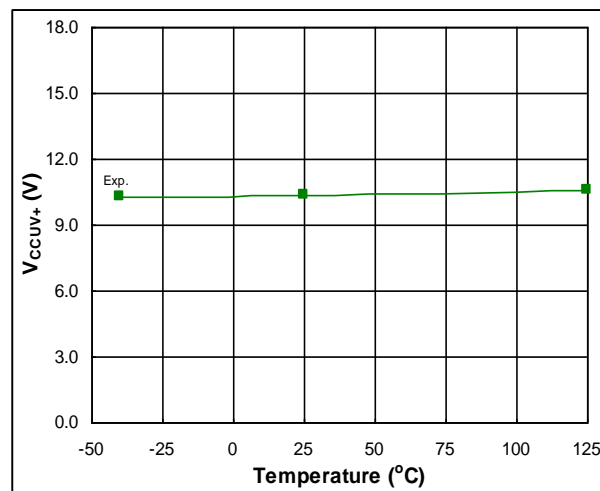

Fig. 34. V<sub>CC</sub> Supply Undervoltage Positive Going Threshold vs. Temperature

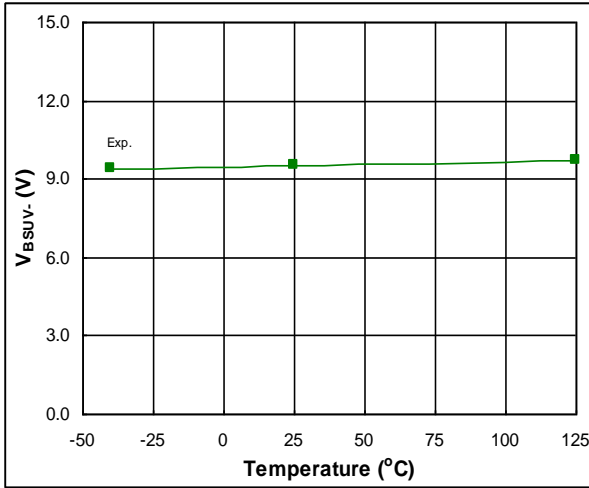

Fig. 35.  $V_{BS}$  Supply Undervoltage Negative Going Threshold vs. Temperature

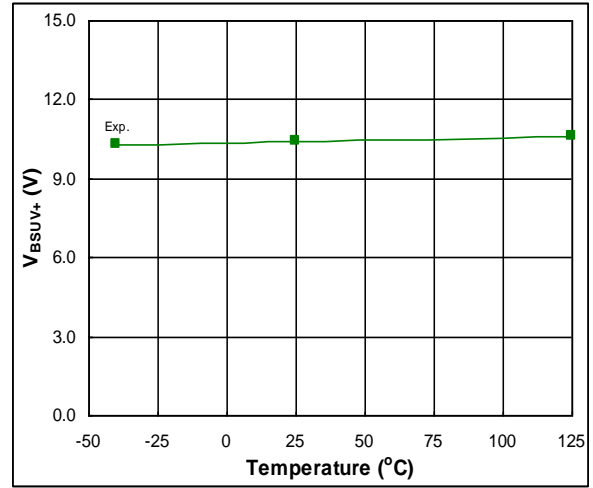

Fig. 36.  $V_{BS}$  Supply Undervoltage Positive Going Threshold vs. Temperature

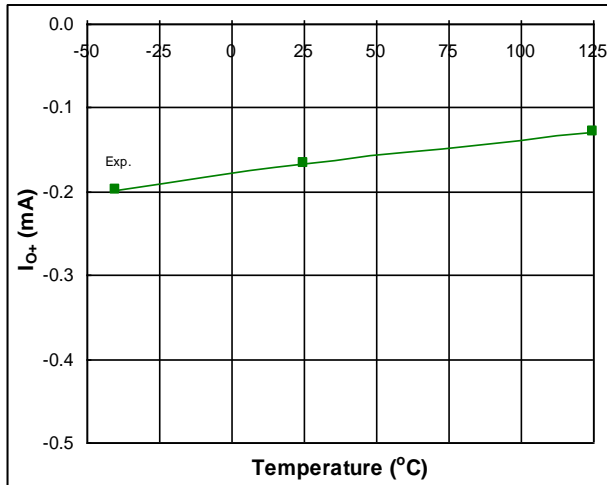

Fig. 37. Output High Short Circuit Pulsed Current vs. Temperature

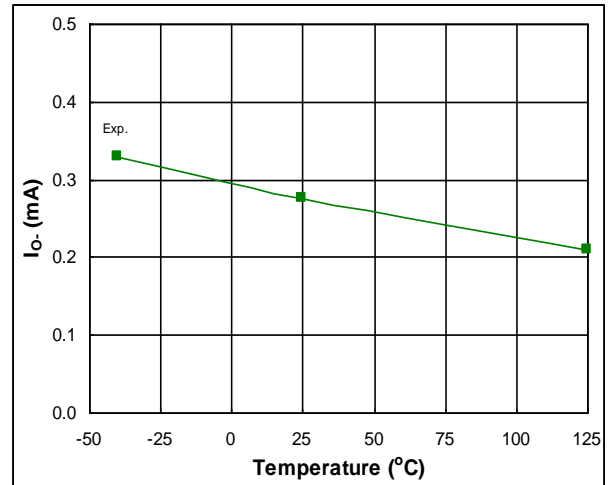

Fig. 38. Output Low Short Circuit Pulsed Current vs. Temperature

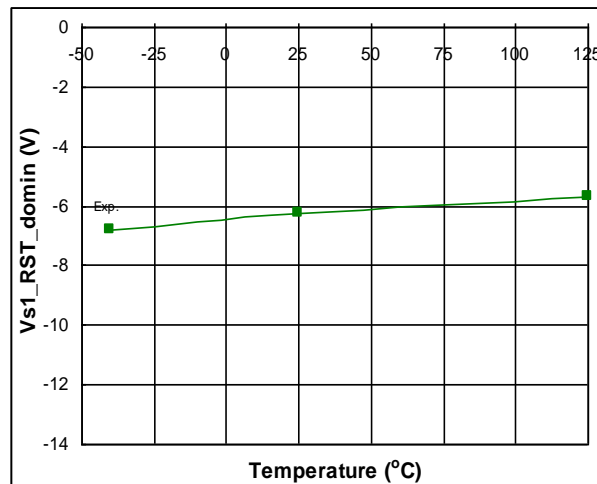

Fig. 39. Max -VS vs. Temperature

Case Outlines

Technical drawing of a 28-Lead SOIC (wide body) showing top, side, and lead detail views with dimensions in millimeters and inches.

NOTES:

1. DIMENSIONING & TOLERANCING PER ANSI Y14.5M-1982.
2. CONTROLLING DIMENSION: MILLIMETER.
3. DIMENSIONS ARE SHOWN IN MILLIMETERS [INCHES].
4. OUTLINE CONFORMS TO JEDEC OUTLINE MS-013AE.
5. DIMENSION IS THE LENGTH OF LEAD FOR SOLDERING TO A SUBSTRATE.
6. DIMENSION DOES NOT INCLUDE MOLD PROTUSIONS. MOLD PROTUSIONS SHALL NOT EXCEED 0.15 [.006].

**28-Lead SOIC (wide body)**

01-6013  
01-3040 02 (MS-013AE)

Technical drawing of a 44-Lead PLCC w/o 12 leads showing top, side, and lead detail views with dimensions in millimeters and inches.

| DIM | MILLIMETERS |       | INCHES |      |
|-----|-------------|-------|--------|------|
|     | MIN         | MAX   | MIN    | MAX  |
| F   | 17.40       | 17.65 | .685   | .695 |
| G   | 17.40       | 17.65 | .685   | .695 |
| H   | 4.20        | 4.57  | .165   | .180 |
| J   | 2.29        | 3.04  | .090   | .120 |
| K   | 0.33        | 0.48  | .013   | .019 |
| L   | 1.27        | BSC   | .050   | BSC  |
| M   | 0.66        | 0.81  | .026   | .032 |
| N   | 0.51        | —     | .020   | —    |
| P   | 0.64        | —     | .025   | —    |
| R   | 16.51       | 16.66 | .650   | .656 |
| S   | 16.51       | 16.66 | .650   | .656 |
| T   | 1.07        | 1.21  | .042   | .048 |
| V   | —           | 0.50  | —      | .020 |
| W   | 5.08        | BSC   | .200   | BSC  |
| L1  | 15.50       | 16.00 | .610   | .630 |
| P1  | 1.53        | —     | .060   | —    |

NOTES:

1. DIMENSIONING & TOLERANCING PER ANSI Y14.5M-1982.
2. DIMENSIONS SHOWN IN MILLIMETERS [INCHES].
3. CONTROLLING DIMENSION: INCH.
4. CONFORMS TO JEDEC OUTLINE MS-018AC.
5. DATUMS -A-, -B-, -C-, & -D- ARE DETERMINED BY WHERE THE TOP OF THE LEADS EXIT PLASTIC BODY AT MOLD PARTING LINE.
6. TO BE MEASURED AT -E- SEATING PLANE.
7. DIMENSIONS DO NOT INCLUDE MOLD FLASH, ALLOWABLE FLASH IS 0.254 [.010].

**44-Lead PLCC w/o 12 leads**

01-6009 00  
01-3004 02(mod.) (MS-018AC)

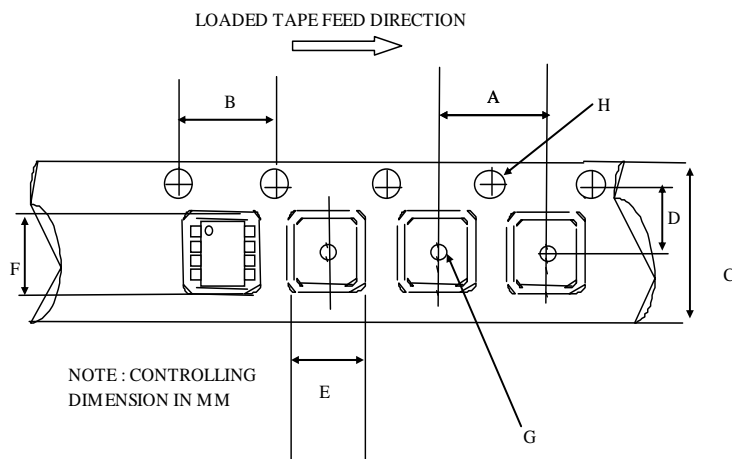

CARRIER TAPE DIMENSION FOR 28SOICW

| Code | Metric |       | Imperial |       |
|------|--------|-------|----------|-------|
|      | Min    | Max   | Min      | Max   |
| A    | 11.90  | 12.10 | 0.468    | 0.476 |
| B    | 3.90   | 4.10  | 0.153    | 0.161 |
| C    | 23.70  | 24.30 | 0.933    | 0.956 |
| D    | 11.40  | 11.60 | 0.448    | 0.456 |
| E    | 10.80  | 11.00 | 0.425    | 0.433 |
| F    | 18.20  | 18.40 | 0.716    | 0.724 |
| G    | 1.50   | n/a   | 0.059    | n/a   |
| H    | 1.50   | 1.60  | 0.059    | 0.062 |

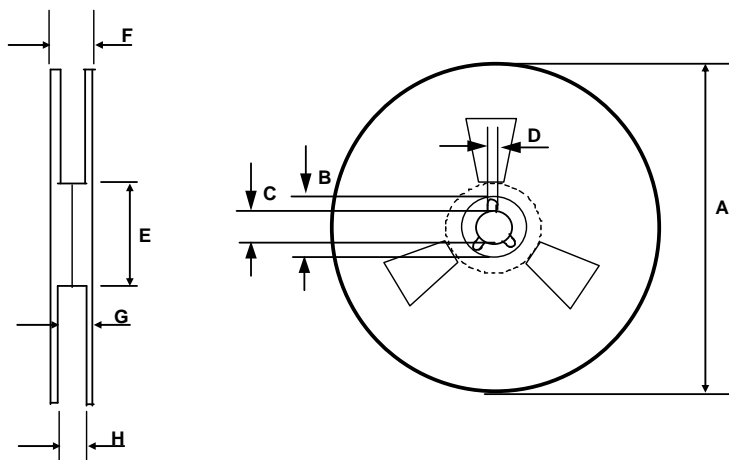

REEL DIMENSIONS FOR 28SOICW

| Code | Metric |        | Imperial |        |
|------|--------|--------|----------|--------|
|      | Min    | Max    | Min      | Max    |
| A    | 329.60 | 330.25 | 12.976   | 13.001 |
| B    | 20.95  | 21.45  | 0.824    | 0.844  |
| C    | 12.80  | 13.20  | 0.503    | 0.519  |
| D    | 1.95   | 2.45   | 0.767    | 0.096  |
| E    | 98.00  | 102.00 | 3.858    | 4.015  |
| F    | n/a    | 30.40  | n/a      | 1.196  |
| G    | 26.50  | 29.10  | 1.04     | 1.145  |
| H    | 24.40  | 26.40  | 0.96     | 1.039  |

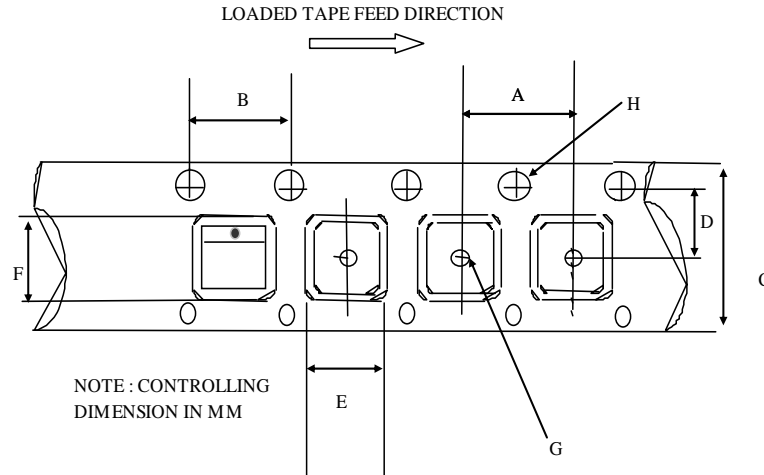

CARRIER TAPE DIMENSION FOR 44PLCC

| Code | Metric |       | Imperial |       |
|------|--------|-------|----------|-------|
|      | Min    | Max   | Min      | Max   |
| A    | 23.90  | 24.10 | 0.94     | 0.948 |
| B    | 3.90   | 4.10  | 0.153    | 0.161 |
| C    | 31.70  | 32.30 | 1.248    | 1.271 |
| D    | 14.10  | 14.30 | 0.555    | 0.562 |
| E    | 17.90  | 18.10 | 0.704    | 0.712 |
| F    | 17.90  | 18.10 | 0.704    | 0.712 |
| G    | 2.00   | n/a   | 0.078    | n/a   |
| H    | 1.50   | 1.60  | 0.059    | 0.062 |

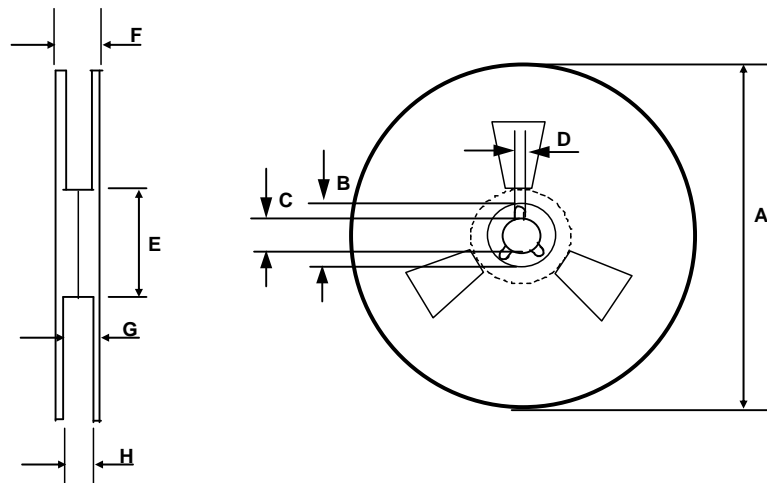

REEL DIMENSIONS FOR 44PLCC

| Code | Metric |        | Imperial |        |
|------|--------|--------|----------|--------|
|      | Min    | Max    | Min      | Max    |
| A    | 329.60 | 330.25 | 12.976   | 13.001 |
| B    | 20.95  | 21.45  | 0.824    | 0.844  |
| C    | 12.80  | 13.20  | 0.503    | 0.519  |
| D    | 1.95   | 2.45   | 0.767    | 0.096  |
| E    | 98.00  | 102.00 | 3.858    | 4.015  |
| F    | n/a    | 38.4   | n/a      | 1.511  |
| G    | 34.7   | 35.8   | 1.366    | 1.409  |
| H    | 32.6   | 33.1   | 1.283    | 1.303  |

**LEAD-FREE PART MARKING INFORMATION**

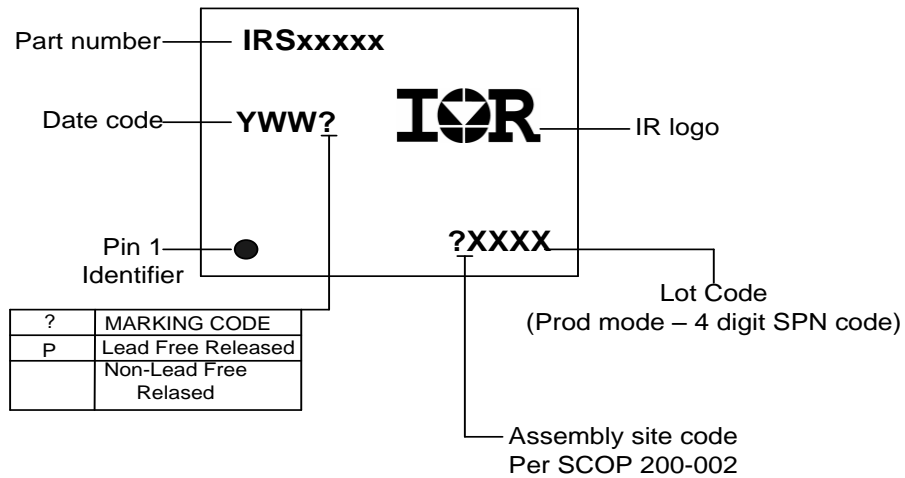

**ORDER INFORMATION**

28-Lead SOIC IR21364SPbF  
 44-Lead PLCC IR21364JPbF

28-Lead SOIC Tape & Reel IR21364STRPbF  
 44-Lead PLCC Tape & Reel IR21364JTRPbF

The information provided in this document is believed to be accurate and reliable. However, International Rectifier assumes no responsibility for the consequences of the use of this information. International Rectifier assumes no responsibility for any infringement of patents or of other rights of third parties which may result from the use of this information. No license is granted by implication or otherwise under any patent or patent rights of International Rectifier. The specifications mentioned in this document are subject to change without notice. This document supersedes and replaces all information previously supplied.

For technical support, please contact IR's Technical Assistance Center  
<http://www.irf.com/technical-info/>

**WORLD HEADQUARTERS:**  
 233 Kansas St., El Segundo, California 90245  
 Tel: (310) 252-7105

**Change History**

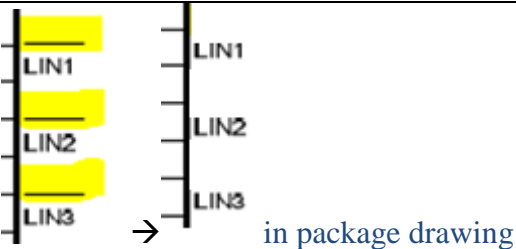
| Revision | Date     | Change comments  |
|----------|----------|--|
| 1.0      | 04/03/08 | Included Qual Info, Replaced “Also available LEAD-FREE” statement in the front page with “RoHS Compliant”, removed typical spec limit for MT, MDT, & PM, added Tri-temp plots, and added disclaimer at end of the datasheet. |
| 2.0      | 5/3/2016 |    |
|          |          |  |
|          |          |  |
|          |          |  |
|          |          |  |
|          |          |  |
|          |          |  |

## Looking for pricing, stock, or lifecycle information?

Click below to explore more details on WIN SOURCE:

 [View IR21364SPBF on WIN SOURCE](#)

 [Infineon Technologies](#) Information

## Optimize Your Supply Chain with WIN SOURCE Solutions

-  Global Sourcing Solution
-  Obsolete Management
-  Cost Control Management
-  Shortage Management
-  Alternative Solution
-  Excess Inventory Management