



**THE DATASHEET OF
LTC1731EMS8-8.4#PBF**



FEATURES

- Complete Linear Charger Controller for 2-Cell Lithium-Ion Batteries
- 1% Voltage Accuracy
- Programmable Charge Current
- C/10 Charge Current Detection Output
- Programmable Charge Termination Timer
- Space Saving 8-Pin MSOP Package
- Automatic Sleep Mode When Input Supply is Removed (15 μ A Battery Drain)
- Automatic Trickle Charging of Low Voltage Cells
- Programmable for Constant-Current-Only Mode

APPLICATIONS

- Cellular Phones
- Handheld Computers
- Charging Docks and Cradles
- Programmable Current Source

DESCRIPTION

The LTC[®]1731-8.2/LTC1731-8.4 are complete constant-current/constant-voltage linear charger controllers for 2-cell lithium-ion (Li-Ion) batteries. Nickel-cadmium (NiCd) and nickel-metal-hydride (NiMH) batteries can also be charged with constant current using external termination. The external sense resistor sets the charge current with 7% accuracy. An internal resistor divider and precision reference set the final float potential with 1% accuracy. The output float voltages are set internally to 8.2V (LTC1731-8.2) or 8.4V (LTC1731-8.4).

When the input supply is removed, the LTC1731-8.2/LTC1731-8.4 automatically enter a low current sleep mode, dropping the battery drain current to typically 15 μ A. An internal comparator detects the end-of-charge (C/10) condition while a programmable timer, using an external capacitor, sets the total charge time. Fully discharged cells are automatically trickle charged at 10% of the programmed current until battery voltage exceeds 4.95V.

The LTC1731-8.2/LTC1731-8.4 are available in the 8-pin MSOP and SO packages. For 1-cell Li-Ion battery charging, see the LTC1731-4.1 and LTC1731-4.2 data sheets.

LT, LTC and LT are registered trademarks of Linear Technology Corporation.

TYPICAL APPLICATION

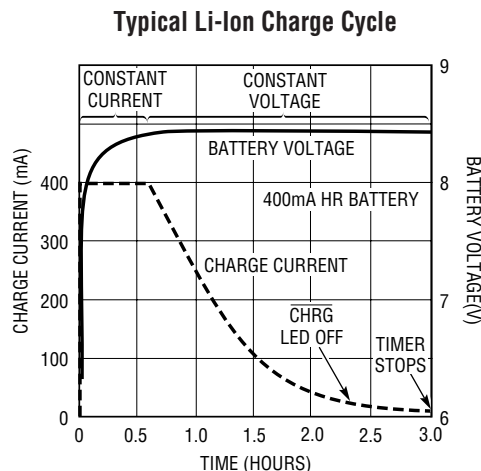
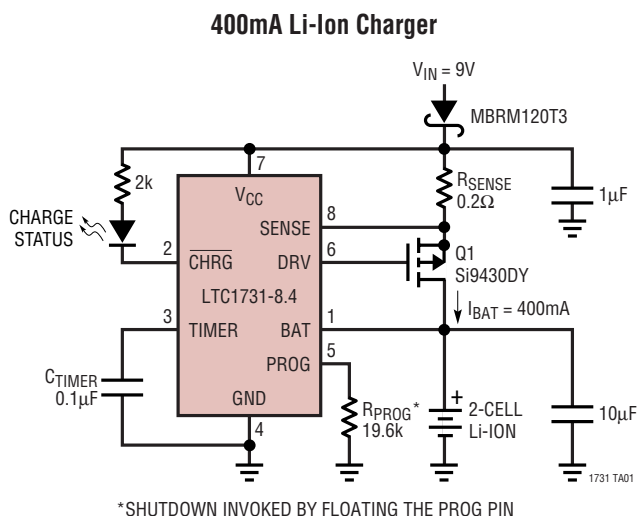

LTC1731-8.2/LTC1731-8.4

ABSOLUTE MAXIMUM RATINGS (Note 1)

Input Supply Voltage (V_{CC})	13.2V	Operating Temperature Range (Note 2)	-40° to 85°C
SENSE, DRV, BAT, TIMER, PROG	-0.3V to V_{CC}	Storage Temperature Range	-65°C to 150°C
CHRG	-0.3V to 13.2V	Lead Temperature (Soldering, 10 sec)	300°C

PACKAGE/ORDER INFORMATION

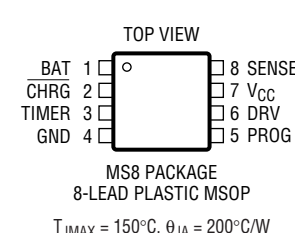
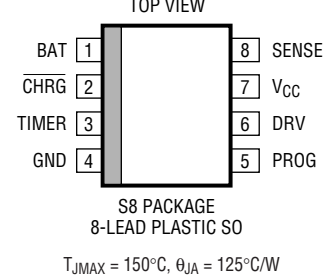
 <p>MS8 PACKAGE 8-LEAD PLASTIC MSOP $T_{JMAX} = 150^{\circ}C, \theta_{JA} = 200^{\circ}C/W$</p>	ORDER PART NUMBER	 <p>S8 PACKAGE 8-LEAD PLASTIC SO $T_{JMAX} = 150^{\circ}C, \theta_{JA} = 125^{\circ}C/W$</p>	ORDER PART NUMBER
	LTC1731EMS8-8.2 LTC1731EMS8-8.4		LTC1731ES8-8.2 LTC1731ES8-8.4
	MS8 PART MARKING		S8 PART MARKING
	LTSW LTPE		173182 173184

Consult LTC Marketing for parts specified with wider operating temperature ranges.

ELECTRICAL CHARACTERISTICS

The ● denotes the specifications which apply over the full operating temperature range, otherwise specifications are at $T_A = 25^{\circ}C$. $V_{CC} = 9V$ unless otherwise noted.

SYMBOL	PARAMETER	CONDITIONS	MIN	TYP	MAX	UNITS	
V_{CC}	Input Supply Voltage		● 8.8		12	V	
I_{CC}	Input Supply Current	Charger On, Current Mode	●	1	3	mA	
		Shutdown Mode	●	1	2	mA	
		Sleep Mode (Battery Drain Current)		15	30	μA	
V_{BAT}	Regulated Output Voltage	LTC1731-8.2 ($9V \leq V_{CC} \leq 12V$)	● 8.118	8.2	8.282	V	
		LTC1731-8.4 ($9V \leq V_{CC} \leq 12V$)	● 8.316	8.4	8.484	V	
I_{BAT}	Current Mode Charge Current	$R_{PROG} = 19.6k, R_{SENSE} = 0.2\Omega$		465	500	535	mA
		$R_{PROG} = 19.6k, R_{SENSE} = 0.2\Omega$	●	415	500	585	mA
		$R_{PROG} = 97.6k, R_{SENSE} = 0.2\Omega$		70	100	130	mA
I_{TRIKL}	Trickle Charge Current	$V_{BAT} = 4V, R_{PROG} = 19.6k, I_{TRIKL} = (V_{CC} - V_{SENSE})/0.2\Omega$	●	30	50	100	mA
V_{TRIKL}	Trickle Charge Threshold Voltage	BAT Rising	●	4.7	4.95	5.1	V
V_{UV}	V_{CC} Undervoltage Lockout Voltage	V_{CC} Rising	●	8.2	8.8	V	
ΔV_{UV}	V_{CC} Undervoltage Lockout Hysteresis	V_{CC} Falling		200		mV	
V_{MSD}	Manual Shutdown Threshold Voltage	PROG Pin Rising		2.457		V	
		PROG Pin Falling		2.446		V	
I_{DRV}	Drive Pin Current	$V_{DRV} = V_{CC} - 2V$		26		μA	

ELECTRICAL CHARACTERISTICS The ● denotes the specifications which apply over the full operating temperature range, otherwise specifications are at $T_A = 25^\circ\text{C}$. $V_{CC} = 9\text{V}$ unless otherwise noted.

SYMBOL	PARAMETER	CONDITIONS	MIN	TYP	MAX	UNITS	
V_{ASD}	Automatic Shutdown Threshold Voltage	$(V_{CC} - V_{BAT})$ Falling	30	54	90	mV	
		$(V_{CC} - V_{BAT})$ Rising	40	69	100	mV	
V_{DIS}	Voltage Mode Disable Threshold Voltage	$V_{DIS} = (V_{CC} - V_{TIMER})$	●		0.4	V	
I_{PROG}	PROG Pin Current	Internal Pull-Up Current, No R_{PROG}		2.5		μA	
	PROG Pin Load Regulation	PROG Pin Source Current, $\Delta V_{PROG} \leq 5\text{mV}$	●	300		μA	
V_{PROG}	PROG Pin Voltage	$R_{PROG} = 19.6\text{k}$		2.457		V	
I_{CHRG}	$\overline{\text{CHRG}}$ Pin Weak Pull-Down Current	$V_{CHRG} = 1\text{V}$	50	100	150	μA	
V_{CHRG}	$\overline{\text{CHRG}}$ Pin Output Low Voltage	$I_{CHRG} = 5\text{mA}$		0.6	1.2	V	
$I_{C/10}$	End of Charge Indication Current Level	$R_{PROG} = 19.6\text{k}$, $R_{SENSE} = 0.2\Omega$	●	25	50	100	mA
t_{TIMER}	TIMER Accuracy	$C_{TIMER} = 0.01\mu\text{F}$		10		%	
V_{CLAMP}	DRV Pin Clamp Voltage	$V_{CLAMP} = V_{CC} - V_{DRV}$, $I_{DRIVE} = 50\mu\text{A}$		6.5		V	

Note 1: Absolute Maximum Ratings are those values beyond which the life of a device may be impaired.

Note 2: The LTC1731E-8.2/LTC1731E-8.4 are guaranteed to meet performance specifications from 0°C to 70°C . Specifications over the -40°C to 85°C operating temperature range are assured by design, characterization and correlation with statistical process controls. Consult factory for I grade parts.

TYPICAL PERFORMANCE CHARACTERISTICS

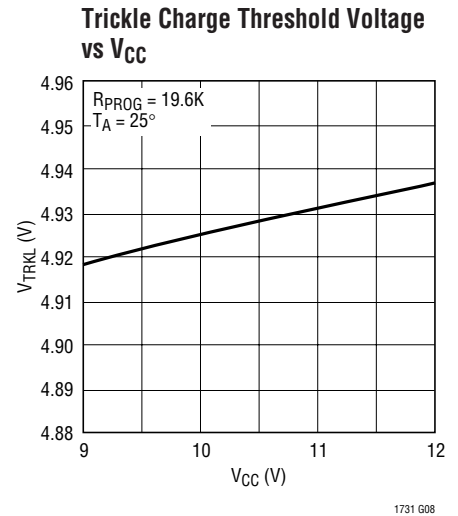
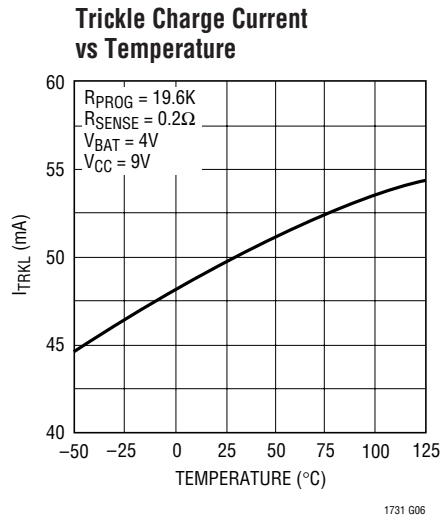
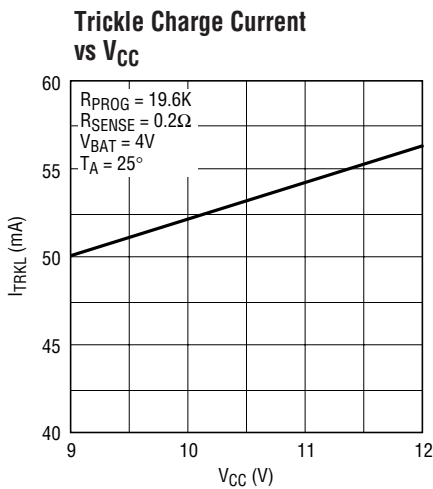

TYPICAL PERFORMANCE CHARACTERISTICS

Trickle Charge Threshold Voltage vs Temperature

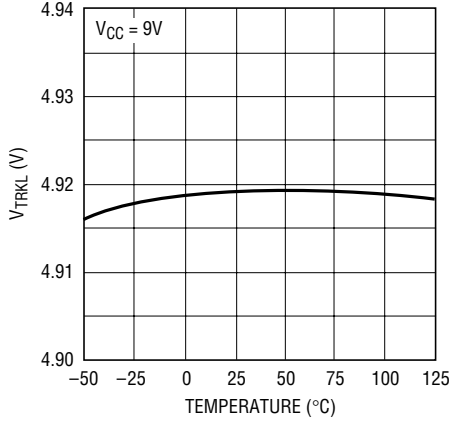

1731 G03

Timer Accuracy vs V_{CC}

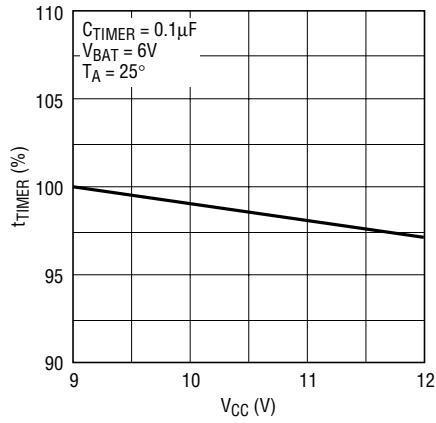

1731 G05

Timer Accuracy vs Temperature

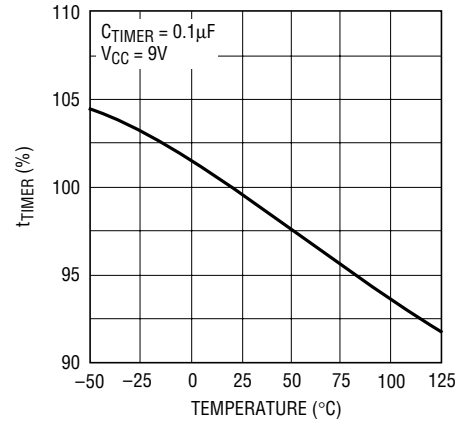

1731 G04

Battery Charge Current vs V_{CC}

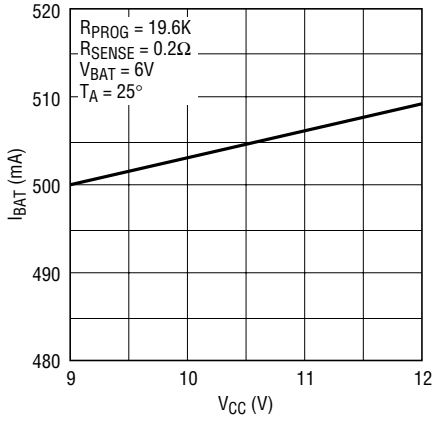

1731 G09

Battery Charge Current vs Temperature

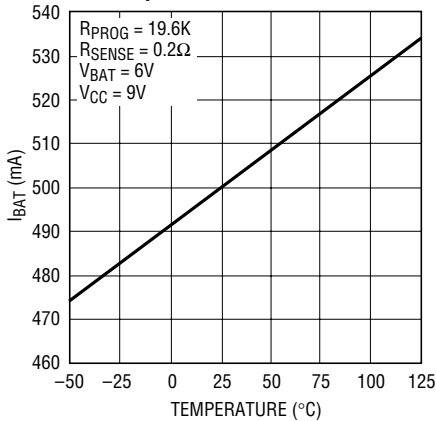

1731 G07

Program Pin Voltage vs V_{CC}

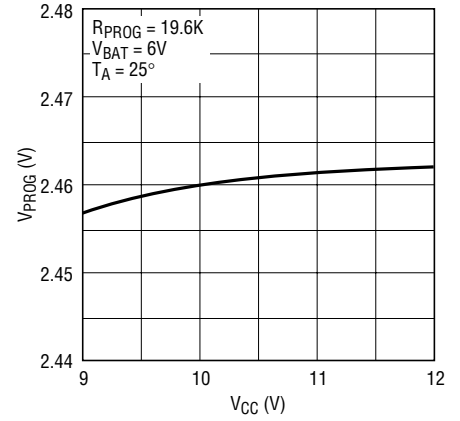

1731 G10

Program Pin Voltage vs Temperature

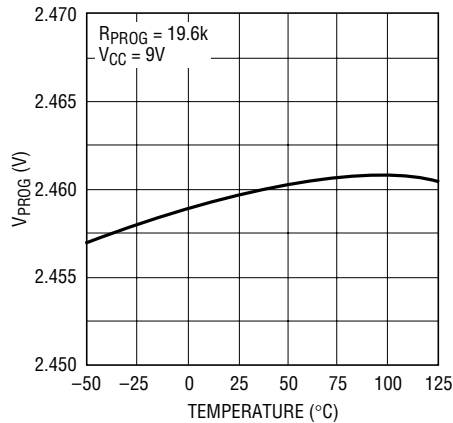

1731 G02

PIN FUNCTIONS

BAT (Pin 1): Battery Sense Input. A bypass capacitor of at least 10 μ F is required to keep the loop stable when the battery is not connected. A precision internal resistive divider sets the final float potential on this pin. The resistor divider is disconnected in sleep mode.

CHRG (Pin 2): Open-Drain Charge Status Output. When the battery is being charged, the CHRG pin is pulled low by an internal N-channel MOSFET. When the charge current drops to 10% of the full-scale current for at least 0.32 seconds, the N-channel MOSFET turns off and a 100 μ A current source is connected from the CHRG pin to GND. When the timer runs out or the input supply is removed, the current source will be disconnected and the CHRG pin is forced into a high impedance state.

TIMER (Pin 3): Timer Capacitor and Constant-Voltage Mode Disable Input Pin. A capacitor C_{TIMER} connected from this pin to ground sets a 30 hour/ μ F time period for charge termination. When the TIMER pin is connected to V_{CC}, the constant-voltage mode and the timer is disabled and the IC will operate in constant-current mode only. Short the TIMER pin to GND to disable the internal timer and the C/10 functions.

GND (Pin 4): Ground.

PROG (Pin 5): Charge Current Program and Shutdown Input Pin. The charge current is programmed by connecting a resistor, R_{PROG} to ground. The charge current is I_{BAT} = (V_{PROG} • 800 Ω)/(R_{PROG} • R_{SENSE}). The IC can be forced into shutdown by floating the PROG pin and allowing the internal 2.5 μ A current source to pull the pin above the 2.457V shutdown threshold voltage.

DRV (Pin 6): Drive Output Pin for the P-Channel MOSFET or PNP Transistor. If a PNP transistor is used, it must have high gain (see Applications Information section). The DRV pin is internally clamped to 6.5V below V_{CC}.

V_{CC} (Pin 7): Input Supply Voltage. V_{CC} ranges from 8.8V to 12V when charging. If V_{CC} drops below V_{BAT} + 54mV, for example when the input supply is disconnected, then the IC enters sleep mode with I_{CC} < 30 μ A. Bypass this pin with a 1 μ F capacitor.

SENSE (Pin 8): Current Sense Input. Connect this pin to the sense resistor. Choose the resistor value using the following equation:

$$R_{SENSE} = (V_{PROG} \cdot 800\Omega) / (R_{PROG} \cdot I_{BAT})$$

BLOCK DIAGRAM

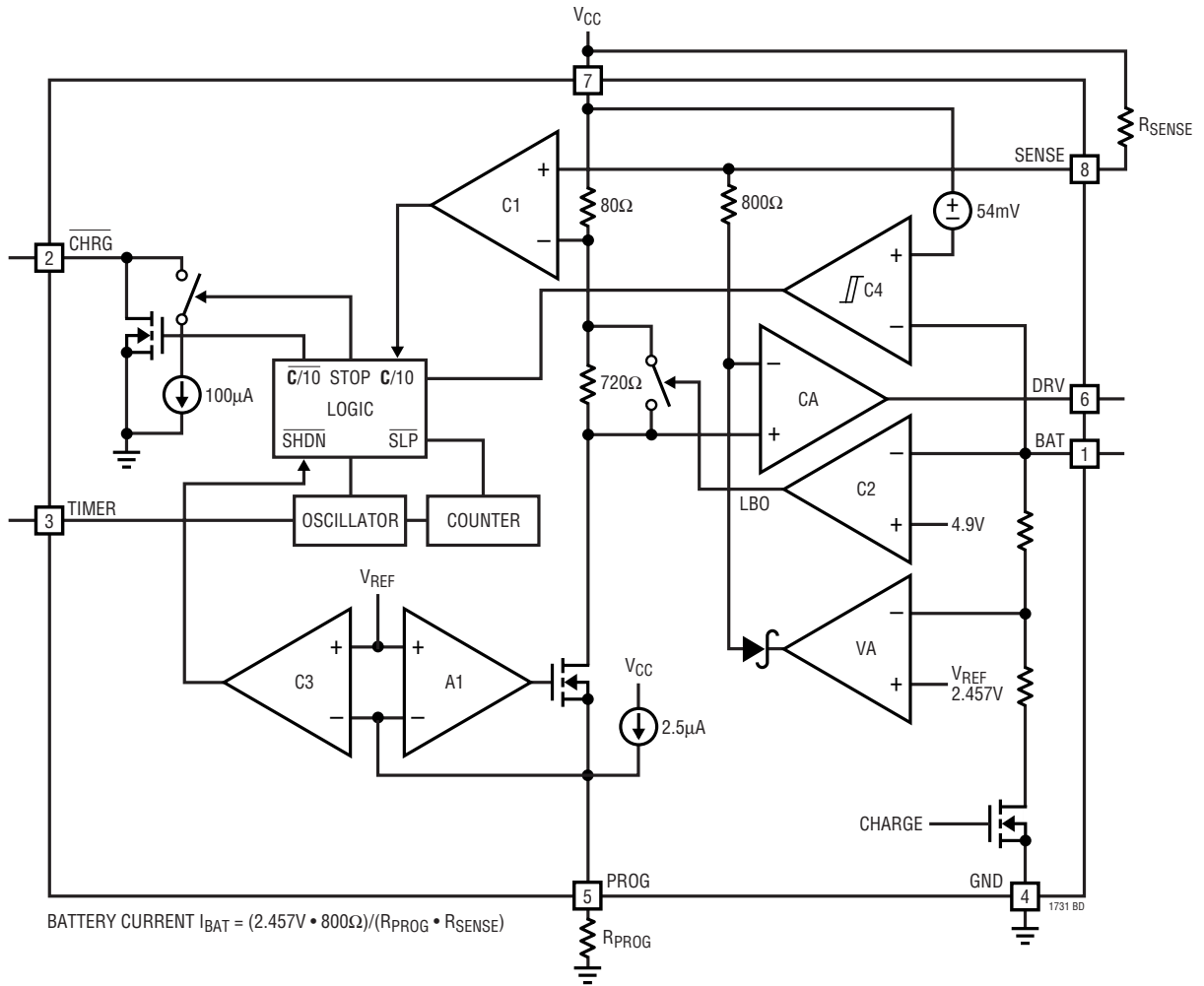

OPERATION

The LTC1731-8.2/LTC1731-8.4 are linear battery charger controllers. The charge current is programmed by the combination of a program resistor (R_{PROG}) from the PROG pin to ground and a sense resistor (R_{SENSE}) between the V_{CC} and SENSE pins. R_{PROG} sets a program current through an internal trimmed 800Ω resistor that creates a voltage drop from V_{CC} to the input of the current amplifier (CA). The current amplifier servos the gate of the external P-channel MOSFET to force the same voltage drop across R_{SENSE} which sets the charge current. When the potential at the BAT pin approaches the preset float voltage, the voltage amplifier (VA) will start sinking current which shrinks the voltage drop across R_{SENSE} , thus reducing the charge current.

Charging begins when the potential at V_{CC} pin rises above the UVLO level and a program resistor is connected from the PROG pin to ground. At the beginning of the charge cycle, if the battery voltage is below 4.95V, the charger goes into trickle charge mode. The trickle charge current is 10% of the full-scale current. If the cell voltage stays low for one quarter of the total charge time, the charge sequence will terminate.

The charger goes into the fast charge constant-current mode after the voltage on the BAT pin rises above 4.95V. In constant-current mode, the charge current is set by the combination of R_{SENSE} and R_{PROG} .

When the battery approaches the final float voltage, the charge current will begin to decrease. When the current drops to 10% of the full-scale charge current, an internal comparator will turn off the N-channel MOSFET at the $\overline{\text{CHRG}}$ pin and connect a weak current source to ground to indicate a near end-of-charge (C/10) condition.

An external capacitor on the TIMER pin sets the total charge time. After a time-out occurs, the charge cycle is terminated and the $\overline{\text{CHRG}}$ pin is forced to a high impedance state. To restart the charge cycle, simply remove the input voltage and reapply it, or float the PROG pin momentarily.

For batteries like lithium-ion that require an accurate final float potential, the internal 2.457V reference, voltage amplifier and the resistor divider provide regulation with $\pm 1\%$ (max) accuracy. For NiMH and NiCd batteries, the LTC1731-8.2/LTC1731-8.4 can be turned into a current source by pulling the TIMER pin to V_{CC} . When in the constant-current only mode, the voltage amplifier, timer and the trickle charge function are all disabled.

The charger can be shut down by floating the PROG pin ($I_{\text{CC}} \approx 1\text{mA}$). An internal current source will pull it high and clamp at 3.5V.

When the input voltage is not present, the charger goes into a sleep mode, dropping I_{CC} to $15\mu\text{A}$. This greatly reduces the current drain on the battery and increases the standby time.

APPLICATIONS INFORMATION

Charger Conditions

The charger is off when any of the following conditions exist: the V_{CC} pin is less than 8.2V, the dropout voltage ($V_{CC} - V_{BAT}$) is less than 54mV, the PROG pin is floating, or the timer has ended. The DRV pin will be pulled to V_{CC} and the internal resistor divider is disconnected to reduce the current drain on the battery.

Undervoltage Lockout (UVLO)

An internal undervoltage lockout circuit monitors the input voltage and keeps the charger in shutdown mode until V_{CC} rises above 8.2V. To prevent oscillation around $V_{CC} = 8.2V$, the UVLO circuit has built-in hysteresis.

Trickle Charge and Defective Battery Detection

At the beginning of the charging sequence, if the battery voltage is less than 4.95V the charger goes into trickle charge mode. The charge current is reduced to 10% of the full-scale current. If the low battery voltage persists for one quarter of the total charging time, the battery is considered defective, charging will be terminated and the CHRG pin output is forced to a high impedance state.

Shutdown

The LTC1731-8.2/LTC1731-8.4 can be forced into shutdown by floating the PROG pin and allowing the internal 2.5 μ A current source to pull the pin above the 2.457V shutdown threshold voltage. The DRV pin is then pulled up to V_{CC} turning off the external P-channel MOSFET. The internal timer is reset in the shutdown mode.

Programming Charge Current

The formula for the battery charge current (see Block Diagram) is:

$$I_{BAT} = (2.457V/R_{PROG})(800\Omega/R_{SENSE})$$

where R_{PROG} is the total resistance from the PROG pin to ground.

For example, if 0.5A charge current is needed, select a value for R_{SENSE} that will drop 100mV at the maximum charge current. $R_{SENSE} = 0.1V/0.5A = 0.2\Omega$, then calculate:

$$R_{PROG} = (2.457V/500mA)(800\Omega/0.2\Omega) = 19.656k$$

For best stability over temperature and time, 1% resistors are recommended. The closest 1% resistor value is 19.6k.

Programming the Timer

The programmable timer is used to terminate the charge. The length of the timer is programmed by an external capacitor at the TIMER pin. The total charge time is:

$$\text{Time (Hours)} = (3 \text{ Hours})(C_{TIMER}/0.1\mu F)$$

The timer starts when the input voltage greater than 8.2V is applied and the program resistor is connected to ground. After a time-out occurs, the CHRG output will become high impedance indicating that the charge cycle has ended. Connecting the TIMER pin to V_{CC} disables the timer and also puts the charger into a constant-current mode. To only disable the timer function, short the TIMER pin to GND.

CHRG Status Output Pin

When the charge cycle starts, the $\overline{\text{CHRG}}$ pin is pulled to ground by an internal N-channel MOSFET that can drive an LED. When the charge current drops to 10% of the full-scale current ($C/10$), the N-channel MOSFET turns off and a weak 100 μ A current source to ground is connected to the CHRG pin. After a time-out occurs, the CHRG pin goes high impedance indicating that the charge cycle has ended. By using two different value pull-up resistors, a microprocessor can detect three states from this pin (charging, $C/10$ and stop charging). See Figure 1.

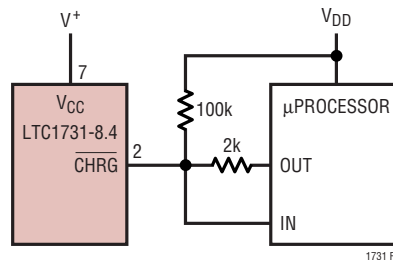

Figure 1. Microprocessor Interface

APPLICATIONS INFORMATION

When the LTC1731 is in the charge mode, the $\overline{\text{CHRG}}$ pin is pulled to ground by an internal N-channel MOSFET. To detect this mode, force the digital output pin, OUT, high and measure the voltage at the $\overline{\text{CHRG}}$ pin. The N-channel MOSFET will pull the pin low even with a 2k pull-up resistor. Once the charge current drops to 10% of the full-scale current ($\text{C}/10$), the N-channel MOSFET is turned off and a 100 μA current source is connected to the $\overline{\text{CHRG}}$ pin. By forcing the OUT pin into a high impedance state, the current source will pull the pin low through the 100k resistor. When the internal timer has expired, the $\overline{\text{CHRG}}$ pin will change to high impedance and the 100k resistor will then pull the pin high to indicate the charge cycle has ended.

End of Charge (C/10)

The LTC1731-8.2/LTC1731-8.4 include a comparator to monitor the charge current to detect a near end-of-charge condition. This comparator does not terminate the charge cycle, but provides an output signal to indicate a near full charge condition. The timer is used to terminate the charge cycle. When the battery current falls below 10% of full scale, the comparator trips and turns off the N-channel MOSFET at the $\overline{\text{CHRG}}$ pin and switches in a 100 μA current source to ground. After an internal time delay of 320ms, this state is then latched. This delay will help prevent false triggering due to transient currents. The end-of-charge comparator is disabled in trickle charge mode.

Gate Drive

Typically the LTC1731-8.2/LTC1731-8.4 drive an external P-channel MOSFET to supply current to the battery. The DRV pin is internally clamped to 6.5V below V_{CC} . This feature allows low voltage P-channel MOSFETs with gate to source breakdown voltage rated at 8V to be used.

An external PNP transistor can also be used as the pass transistor instead of the P-channel MOSFET. Due to the low current gain of the current amplifier (CA), a high gain Darlington PNP transistor is required to avoid excessive charging current error. The gain of the current amplifier is around 0.6 $\mu\text{A}/\text{mV}$. For every 1 μA of base current, a 1.6mV gain error shows up at the inputs of CA. With $R_{\text{PROG}} = 19.6\text{k}$ and 100mV across R_{SENSE} , this gain error causes a 1.67% error in charge current.

Constant-Current Only Mode

The LTC1731-8.2/LTC1731-8.4 can be used as a programmable current source by forcing the TIMER pin to V_{CC} . This is particularly useful for charging NiMH or NiCd batteries. In the constant-current only mode, the timer and voltage amplifier are both disabled. An external termination method is required to properly terminate the charge.

Stability

The charger is stable without any compensation when a P-channel MOSFET is used as the pass transistor. However, a 10 μF capacitor is recommended at the BAT pin to keep the ripple voltage low when the battery is disconnected. A ceramic output capacitor may also be used, but because of the very low ESR and high Q characteristics of multilayer ceramic capacitors, it may be necessary to add a 1 Ω resistor in series with the ceramic capacitor to improve voltage mode stability.

When a PNP transistor is chosen as the pass transistor, a 1000pF capacitor is required from the DRV pin to V_{CC} . This capacitor is needed to help stabilize the voltage loop. A 10 μF capacitor at the BAT pin is also recommended when a battery is not present.

PACKAGE DESCRIPTION

MS8 Package
8-Lead Plastic MSOP
 (Reference LTC DWG # 05-08-1660)

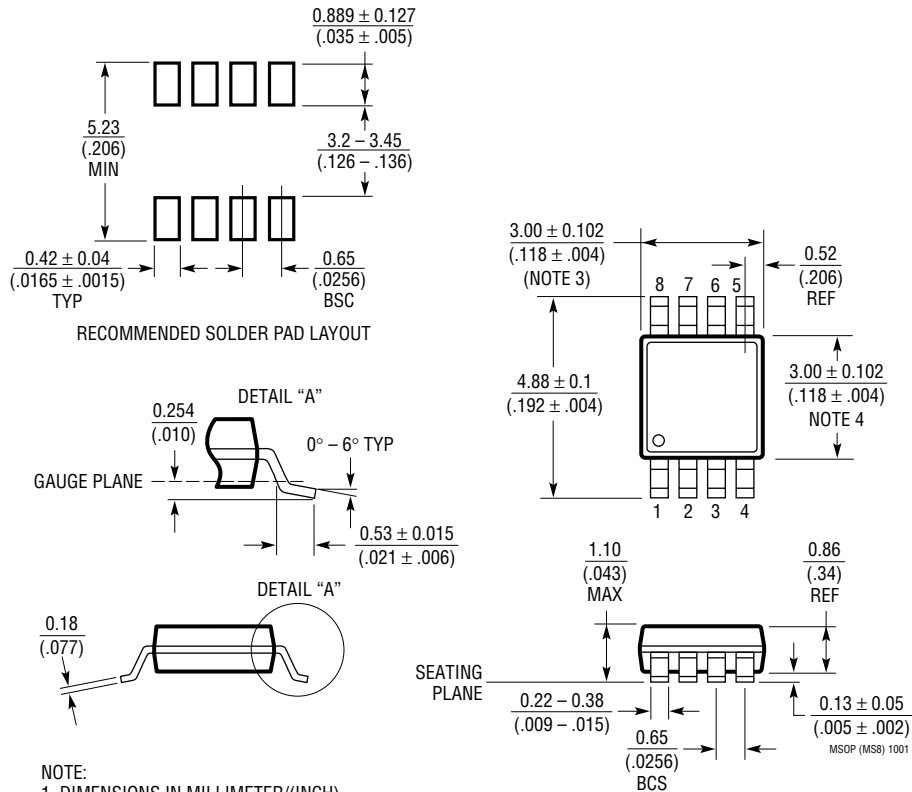

- NOTE:
1. DIMENSIONS IN MILLIMETER/(INCH)
 2. DRAWING NOT TO SCALE
 3. DIMENSION DOES NOT INCLUDE MOLD FLASH, PROTRUSIONS OR GATE BURRS.
MOLD FLASH, PROTRUSIONS OR GATE BURRS SHALL NOT EXCEED 0.152mm (.006") PER SIDE
 4. DIMENSION DOES NOT INCLUDE INTERLEAD FLASH OR PROTRUSIONS.
INTERLEAD FLASH OR PROTRUSIONS SHALL NOT EXCEED 0.152mm (.006") PER SIDE
 5. LEAD COPLANARITY (BOTTOM OF LEADS AFTER FORMING) SHALL BE 0.102mm (.004") MAX

PACKAGE DESCRIPTION

S8 Package
8-Lead Plastic Small Outline (Narrow .150 Inch)
 (Reference LTC DWG # 05-08-1610)

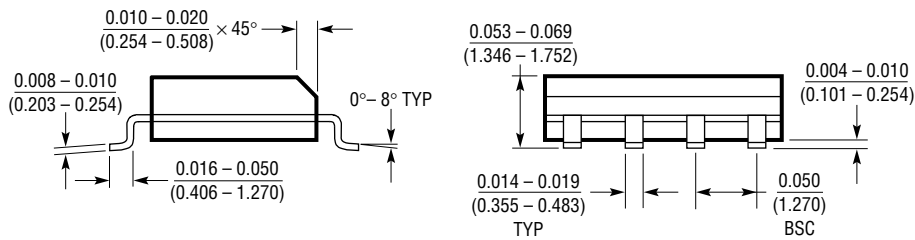
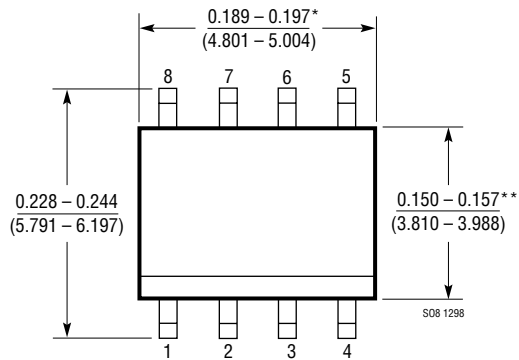

*DIMENSION DOES NOT INCLUDE MOLD FLASH. MOLD FLASH SHALL NOT EXCEED 0.006" (0.152mm) PER SIDE

**DIMENSION DOES NOT INCLUDE INTERLEAD FLASH. INTERLEAD FLASH SHALL NOT EXCEED 0.010" (0.254mm) PER SIDE

TYPICAL APPLICATION

Linear Charger Using a PNP Transistor

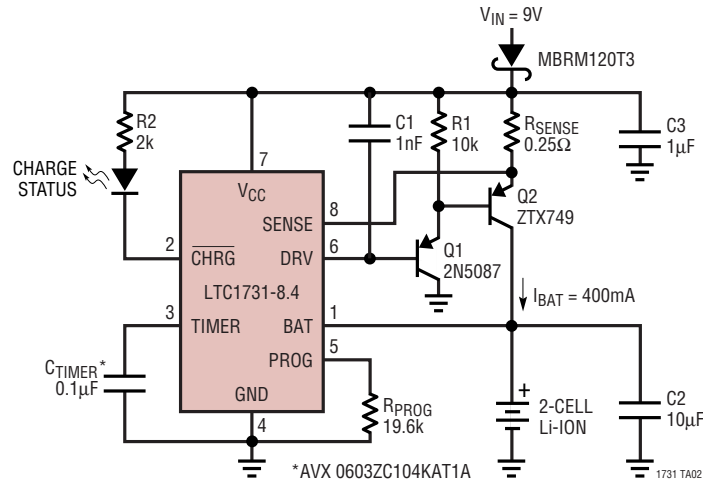



RELATED PARTS

PART NUMBER	DESCRIPTION	COMMENTS
LT [®] 1510-5	500kHz Constant-Voltage/Constant-Current Battery Charger	Most Compact, Up to 1.5A, Charges NiCd, NiMH, Li-Ion Cells
LT1512	SEPIC Battery Charger	V _{IN} Can Be Higher or Lower Than Battery Voltage, 1.5A Switch
LT1571-1/-2/-5	200kHz/500kHz 1.5A Constant-Current/Constant-Voltage Battery Charger	Charges 1- or 2-Cell Li-Ion Batteries, Preset and Adjustable Battery Voltages, C/10 Charge Detection
LTC1615	SOT-23 Step-Up Switching Regulator	1.2V ≤ V _{IN} ≤ 15V; Up to 34 Output; I _Q = 20μA
LT1620	Rail-to-Rail Current Sense Amplifier	Precise Output Current Programming, Up to 32V V _{OUT}
LTC1682	Low Noise Doubler Charge Pump	Output Noise = 60μV _{RMS} ; 2.5V to 5.5V Output
LTC1729	Termination Controller for Li-Ion	Time or Charge Current Termination, Automatic Charger/Battery Detection, Status Output, Preconditioning, 8-Lead MSOP
LTC1730	Complete Li-Ion Pulse Battery Charger with Internal FET and Thermal Regulation	Efficient 1.5A Charger with Many Features Including Overcurrent Battery Protection
LTC1731-4.1/-4.2	Complete Li-Ion Linear Battery Charger Controller	Single Cell Li-Ion; C/10 Detection; Complete Charger
LTC1732	Complete Li-Ion Linear Battery Charger Controller	No Firmware Required; AC Adapter Indicator Automatic Charge and Recharge
LTC1733	Complete Li-Ion Linear Battery Charger with Internal FET	1.5A Charger with Many Features Including Thermal Feedback for Increased Charge Current without Exceeding Maximum Temperature
LTC1734	ThinSOT Li-Ion Charger	Only Two External Components; V _{PROG} Tracks I _{CHARGE} No Diode Needed, No Sense Resistor Needed
LTC1754	ThinSOT Charge Pump	I _{OUT} = 50mA; 2V ≤ V _{IN} ≤ 4.4V; for Backlight White LED
LTC4050	Complete Li-Ion Charger with Thermistor Interface	No Firmware required, AC Adapter Indicator Automatic Charge and Recharge

Looking for pricing, stock, or lifecycle information?

Click below to explore more details on WIN SOURCE:

-  [View LTC1731EMS8-8.4#PBF on WIN SOURCE](#)
-  [Linear Technology](#) Information

Optimize Your Supply Chain with WIN SOURCE Solutions

-  Global Sourcing Solution
-  Obsolete Management
-  Cost Control Management
-  Shortage Management
-  Alternative Solution
-  Excess Inventory Management