



**THE DATASHEET OF
MAX9770EUI+**



1.2W, Low-EMI, Filterless, Mono Class D Amplifier with Stereo DirectDrive Headphone Amplifiers

General Description

The MAX9770 combines a mono, filterless, Class D speaker amplifier and stereo DirectDrive® headphone amplifier in a single device. The MAX9770 operates from a single 2.5V to 5.5V supply and includes features that reduce external component count, system cost, board space, and offer improved audio reproduction.

The speaker amplifier makes use of Maxim's Class D architecture, providing Class AB performance with Class D efficiency, conserving board space, and extending battery life. The speaker amplifier delivers 1.2W into an 8Ω load while offering efficiencies above 85%. A spread-spectrum modulation scheme reduces radiated emissions caused by the modulation frequency. Furthermore, the MAX9770 oscillator can be synchronized to an external clock through the SYNC input, avoiding possible problem frequencies inside a system. The speaker amplifier features THD+N as low as 0.025%, high 70dB PSRR, and SNR in excess of 90dB.

The headphone amplifiers feature Maxim's DirectDrive architecture that produces a ground-referenced output from a single supply, eliminating the need for large DC-blocking capacitors. The headphone amplifiers deliver up to 80mW into a 16Ω load, feature low 0.015% THD+N, high 85dB PSRR, and ±8kV ESD-protected outputs. A headphone sense input detects the presence of a headphone, and automatically configures the amplifiers for either speaker or headphone mode.

The MAX9770 includes internally set, logic-selectable gain, and a comprehensive input multiplexer/mixer, allowing multiple audio sources to be selected and for true mono reproduction of a stereo source in speaker mode. Industry-leading click-and-pop suppression eliminates audible transients during power and shutdown cycles. A low-power shutdown mode decreases supply current consumption to 0.1μA, further extending battery life.

The MAX9770 is offered in space-saving, thermally efficient 28-pin TQFN (5mm x 5mm x 0.8mm) and 28-pin TSSOP packages. The MAX9770 features thermal-overload and output short-circuit protection, and is specified over the extended -40°C to +85°C temperature range.

Applications

Cellular Phones
Compact Notebooks
PDAs

Features

- ◆ 1.2W Filterless Class D Amplifiers Pass FCC Class B Radiated EMI Standards with 100mm of Cable
- ◆ Spread-Spectrum Mode Offers 5dB EMI Improvement over Conventional Methods
- ◆ 80mW DirectDrive Headphone Amplifier Eliminates Bulky DC-Blocking Capacitors
- ◆ High 85dB PSRR at 217Hz
- ◆ 85% Efficiency
- ◆ Low 0.015% THD+N
- ◆ Industry-Leading Click-and-Pop Suppression
- ◆ Integrated 3-Way Input Mixer/Multiplexer (MAX9770)
- ◆ Logic-Adjustable Gain
- ◆ Short-Circuit and Thermal Protection
- ◆ Available in Space-Saving, Thermally Efficient Packages

Ordering Information

PART	PIN-PACKAGE	SELECTABLE INPUTS
MAX9770ETI+	28 TQFN-EP*	2 stereo, 1 mono
MAX9770EUI	28 TSSOP	2 stereo, 1 mono

Note: All devices specified over the -40°C to +85°C operating temperature range.

*EP = Exposed pad.

+Denotes a lead-free package.

Pin Configuration appears at end of data sheet.

Simplified Block Diagram

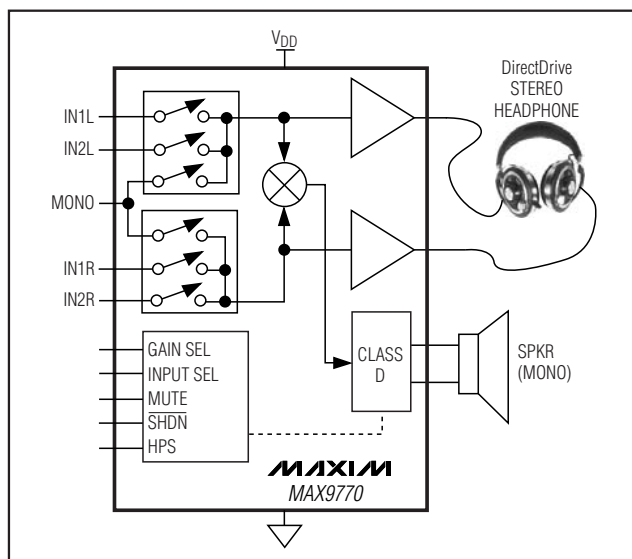

1.2W, Low-EMI, Filterless, Mono Class D Amplifier with Stereo DirectDrive Headphone Amplifiers

ABSOLUTE MAXIMUM RATINGS

GND to PGND to CPGND	-0.3V to +0.3V
V _{DD} to PV _{DD} to CPV _{DD}	-0.3V to +0.3V
V _{DD} to GND	+6V
PV _{DD} to PGND	+6V
CPV _{DD} to CPGND	+6V
CPV _{SS} to CPGND	-6V
SV _{SS} to GND	-6V
C1N	(PV _{SS} - 0.3V) to (CPGND + 0.3V)
HPOUT ₋ to GND	±3V
All Other Pins to GND	-0.3V to (V _{DD} + 0.3V)
Continuous Current Into/Out of:	
PV _{DD} , PGND, OUT ₋	600mA
PV _{SS}	260mA
Duration of HPOUT ₋ Short Circuit to V _{DD} , PV _{DD} , GND, PGND	Continuous

Duration of Short Circuit Between HPOUTL and HPOUTR	Continuous
Duration of OUT ₋ Short Circuit to V _{DD} , PV _{DD} , GND, PGND	10s
Duration of Short Circuit Between OUT ₊ and OUT ₋	10s
Continuous Power Dissipation (T _A = +70°C)	
28-Pin TQFN (derate 20.8mW/°C above +70°C)	1667mW
28-Pin TSSOP (derate 12.8mW/°C above +70°C)	1026mW
Junction Temperature	+150°C
Operating Temperature Range	-40°C to +85°C
Storage Temperature Range	-65°C to +150°C
Lead Temperature (soldering, 10s)	+300°C

Stresses beyond those listed under "Absolute Maximum Ratings" may cause permanent damage to the device. These are stress ratings only, and functional operation of the device at these or any other conditions beyond those indicated in the operational sections of the specifications is not implied. Exposure to absolute maximum rating conditions for extended periods may affect device reliability.

ELECTRICAL CHARACTERISTICS

(V_{DD} = PV_{DD} = CPV_{DD} = 3.3V, GND = PGND = CPGND = 0V, $\overline{\text{SHDN}}$ = 3.3V, C1 = C2 = 1μF, C_{BIAS} = 0.047μF, SYNC = GND, R_L = ∞, speaker load connected between OUT₊ and OUT₋, headphone load connected between HPOUT₋ and GND, T_A = T_{MIN} to T_{MAX}, unless otherwise noted. Typical values are at T_A = +25°C.) (Notes 1, 2)

PARAMETER	SYMBOL	CONDITIONS		MIN	TYP	MAX	UNITS
GENERAL							
Supply Voltage Range	V _{DD}	Inferred from PSRR test		2.5		5.5	V
Quiescent Supply Current	I _{DD}	No load	Headphone mode		5.5	10	mA
			Speaker mode		5.2	7.5	
Shutdown Supply Current	I _{SHDN}	SHDN = HPS = GND			0.1	10	μA
Shutdown to Full Operation	t _{ON}				50		ms
Input Impedance	R _{IN}	(Note 3)	MONO	7	10		kΩ
			INL ₋ , INR ₋	14	20		
Bias Voltage	V _{BIAS}			1.1	1.25	1.4	V
Feedthrough		From any unselected input to any output, f = 10kHz			70		dB
SPEAKER AMPLIFIER (GAIN1 = GAIN2 = V_{DD}, HPS = GND)							
Output Offset Voltage	V _{OS}				±15	±70	mV
Power-Supply Rejection Ratio	PSRR	(Note 4)	V _{DD} = 2.5V to 5.5V, T _A = +25°C	50	70		dB
			V _{RIPPLE} = 200mV _{P-P} , f = 217Hz		70		
			V _{RIPPLE} = 200mV _{P-P} , f = 1kHz		68		
			V _{RIPPLE} = 200mV _{P-P} , f = 20kHz		50		
Output Power	P _{OUT}	f = 1kHz, THD+N = 1%, GAIN1 = 1, GAIN2 = 0	V _{DD} = 3.3V	R _L = 8Ω		550	mW
				R _L = 4Ω		900	
			V _{DD} = 5V	R _L = 8Ω		1200	

1.2W, Low-EMI, Filterless, Mono Class D Amplifier with Stereo DirectDrive Headphone Amplifiers

MAX9770

ELECTRICAL CHARACTERISTICS (continued)

($V_{DD} = PV_{DD} = CPV_{DD} = 3.3V$, $GND = PGND = CPGND = 0V$, $\overline{SHDN} = 3.3V$, $C1 = C2 = 1\mu F$, $C_{BIAS} = 0.047\mu F$, $SYNC = GND$, $R_L = \infty$, speaker load connected between $OUT+$ and $OUT-$, headphone load connected between $HPOUT-$ and GND , $T_A = T_{MIN}$ to T_{MAX} , unless otherwise noted. Typical values are at $T_A = +25^\circ C$.) (Notes 1, 2)

PARAMETER	SYMBOL	CONDITIONS		MIN	TYP	MAX	UNITS	
Total Harmonic Distortion Plus Noise	THD+N	$R_L = 8\Omega$, $P_{OUT} = 300mW$, $f = 1kHz$			0.025		%	
		$R_L = 4\Omega$, $P_{OUT} = 300mW$, $f = 1kHz$			0.03			
		$R_L = 8\Omega$, $P_{OUT} = 500mW$, $f = 1kHz$			0.1			
Signal-to-Noise Ratio	SNR	$R_L = 8\Omega$, $V_{OUT} = 2V_{RMS}$, A-weighted			85.9		dB	
Output Switching Frequency	f_s	SYNC = GND		980	1100	1220	kHz	
		SYNC = unconnected		1280	1450	1620		
		SYNC = V_{DD}			1220	$\pm 120kHz$		
SYNC Frequency Lock Range				800		2000	kHz	
Efficiency	η	$P_O = 1000mW$, $f = 1kHz$			85		%	
Gain (MAX9770)	A_v	GAIN1 = 0, GAIN2 = 0			6		dB	
		GAIN1 = 0, GAIN2 = 1			3			
		GAIN1 = 1, GAIN2 = 0			9			
		GAIN1 = 1, GAIN2 = 1			0			
Gain Accuracy						± 5	%	
Speaker Path Off-Isolation		HPS = V_{DD} , headphone amplifier active, $f = 1kHz$			102		dB	
Click-and-Pop Level	K_{CP}	Peak voltage, A-weighted, 32 samples per second (Notes 4, 5)	Into shutdown		-76		dB	
			Out of shutdown		-55			
			Into mute		-83			
			Out of mute		-69			
HEADPHONE AMPLIFIER (GAIN1 = 1, GAIN2 = 0, HPS = V_{DD})								
Output Offset Voltage	V_{OS}				± 5	± 10	mV	
Power-Supply Rejection Ratio	PSRR	(Note 4)	$V_{DD} = 2.5V$ to $5.5V$, $T_A = +25^\circ C$	65	76		dB	
			$V_{RIPPLE} = 200mV_{P-P}$, $f = 217Hz$		75			
			$V_{RIPPLE} = 200mV_{P-P}$, $f = 1kHz$		82			
			$V_{RIPPLE} = 200mV_{P-P}$, $f = 20kHz$		56			
Output Power	P_{OUT}	$T_A = +25^\circ C$, $f = 1kHz$, THD+N = 1% (Note 3)	$V_{DD} = 3.3V$	$R_L = 32\Omega$	40	55	mW	
				$R_L = 16\Omega$		40		
			$V_{DD} = 5V$	$R_L = 32\Omega$		60		
				$R_L = 16\Omega$		80		
Total Harmonic Distortion Plus Noise	THD+N	$R_L = 32\Omega$, $P_{OUT} = 50mW$, $f = 1kHz$			0.015		%	
		$R_L = 16\Omega$, $P_{OUT} = 35mW$, $f = 1kHz$			0.03			

1.2W, Low-EMI, Filterless, Mono Class D Amplifier with Stereo DirectDrive Headphone Amplifiers

ELECTRICAL CHARACTERISTICS (continued)

($V_{DD} = PV_{DD} = CPV_{DD} = 3.3V$, $GND = PGND = CPGND = 0V$, $\overline{SHDN} = 3.3V$, $C1 = C2 = 1\mu F$, $C_{BIAS} = 0.047\mu F$, $SYNC = GND$, $R_L = \infty$, speaker load connected between $OUT+$ and $OUT-$, headphone load connected between $HPOUT-$ and GND , $T_A = T_{MIN}$ to T_{MAX} , unless otherwise noted. Typical values are at $T_A = +25^\circ C$.) (Notes 1, 2)

PARAMETER	SYMBOL	CONDITIONS	MIN	TYP	MAX	UNITS
Signal-to-Noise Ratio	SNR	$R_L = 32\Omega$, $V_{OUT} = 300mV_{RMS}$, $BW = 22Hz$ to $22kHz$		101		dB
Crosstalk		Between channels, $f = 1kHz$, $V_{IN} = 200mV_{P-P}$		80		dB
Headphone Off-Isolation		HPS = GND, speaker amplifier active, $f = 1kHz$		96		dB
Click-and-Pop Level	KCP	Peak voltage, A-weighted, 32 samples per second (Notes 4, 5)	Into shutdown		-58	dBV
			Out of shutdown		-53	
			Into mute		-92	
			Out of mute		-73	
Capacitive-Load Drive	C_L			1000		pF
Gain	A_V	GAIN1 = 0, GAIN2 = 0		7		dB
		GAIN1 = 0, GAIN2 = 1		4		
		GAIN1 = 1, GAIN2 = 0		-2		
		GAIN1 = 1, GAIN2 = 1		1		
Gain Accuracy					± 2.5	%
ESD Protection		HPOUTR, HPOUTL, IEC Air Discharge		± 8		kV
DIGITAL INPUTS (\overline{SHDN}, SYNC, HPS, GAIN_, SEL_)						
Input Voltage High	V_{IH}		2			V
Input Voltage Low	V_{IL}				0.8	V
Input Leakage Current (Note 6)		SYNC input			± 25	μA
		All other logic inputs			± 1	
HPS Input Current		HPS = GND			-10	μA

Note 1: All devices are 100% production tested at $+25^\circ C$. All temperature limits are guaranteed by design.

Note 2: Speaker amplifier testing performed with a resistive load in series with an inductor to simulate an actual speaker load. For $R_L = 4\Omega$, $L = 47\mu H$. For $R_L = 8\Omega$, $L = 68\mu H$.

Note 3: Guaranteed by design, not production tested.

Note 4: Inputs AC-coupled to GND.

Note 5: Speaker mode testing performed with an 8Ω resistive load in series with a $68\mu H$ inductive load connected across BTL output. Headphone mode testing performed with a 32Ω resistive load connected to GND. Mode transitions are controlled by \overline{SHDN} . KCP level is calculated as: $20 \times \log [(peak\ voltage\ during\ mode\ transition,\ no\ input\ signal)/(peak\ voltage\ under\ normal\ operation\ at\ rated\ power\ level)]$. Units are expressed in dB. Measured with $V_{DD} = 5V$.

Note 6: SYNC has a $200k\Omega$ resistor to $V_{REF} = 1.25V$.

1.2W, Low-EMI, Filterless, Mono Class D Amplifier with Stereo DirectDrive Headphone Amplifiers

Typical Operating Characteristics

MAX9770

($V_{DD} = 3.3V$, BW = 22Hz to 22kHz, GAIN1 = 1, GAIN2 = 0, spread-spectrum mode, headphone outputs in phase, unless otherwise noted.)

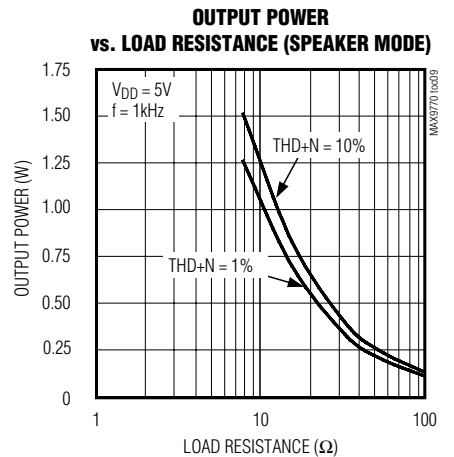
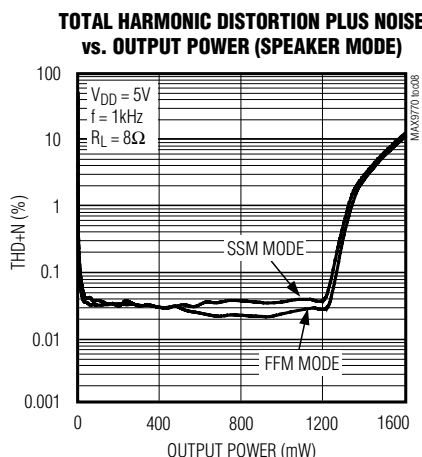
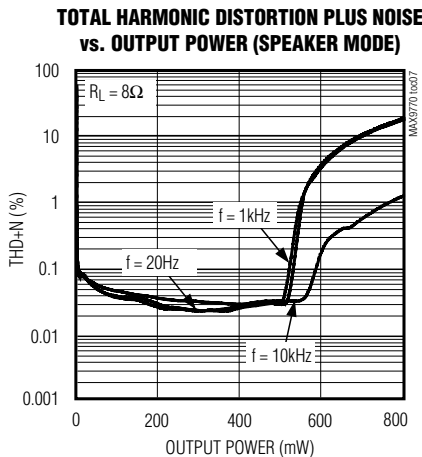
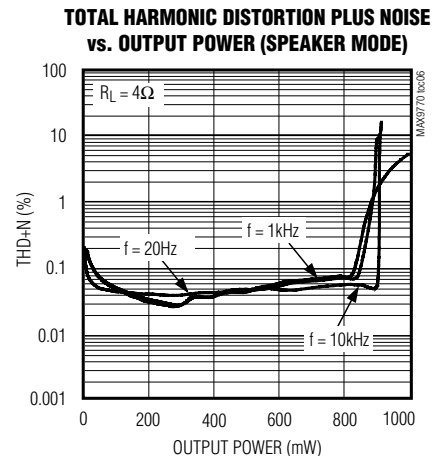
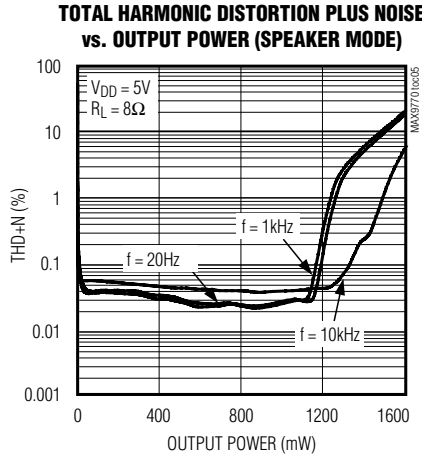
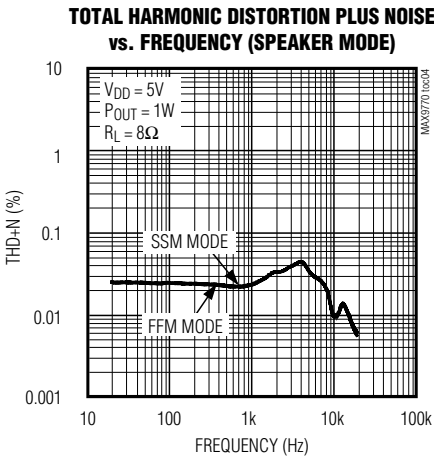
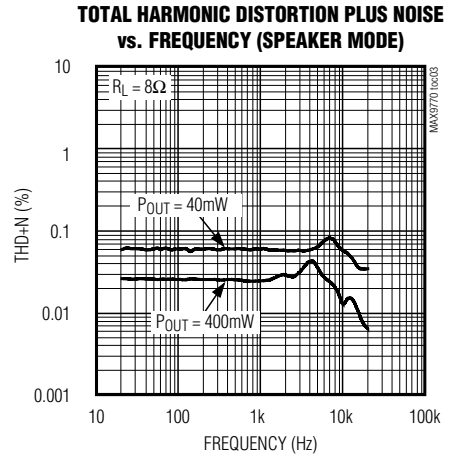
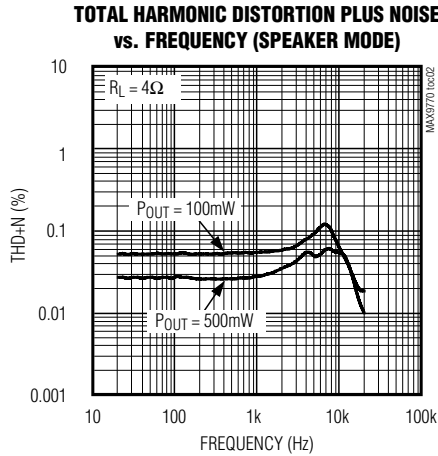
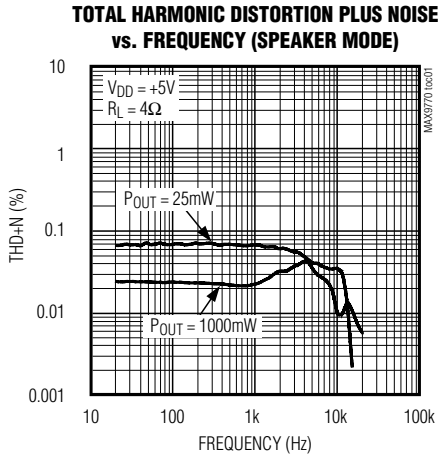

1.2W, Low-EMI, Filterless, Mono Class D Amplifier with Stereo DirectDrive Headphone Amplifiers

Typical Operating Characteristics (continued)

($V_{DD} = 3.3V$, $BW = 22Hz$ to $22kHz$, $GAIN1 = 1$, $GAIN2 = 0$, spread-spectrum mode, headphone outputs in phase, unless otherwise noted.)

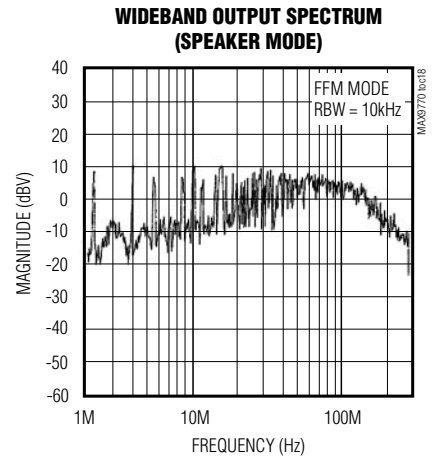
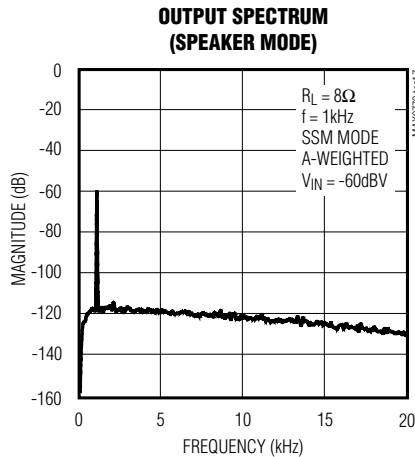
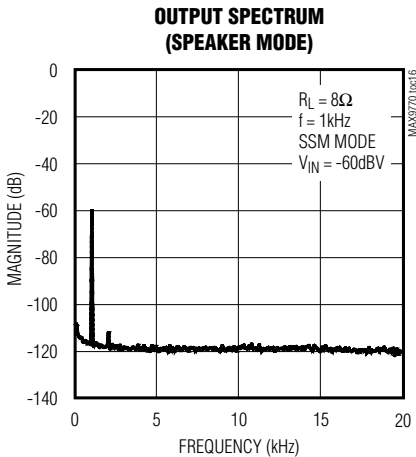
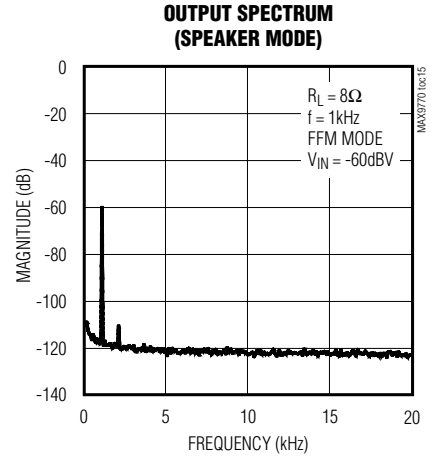
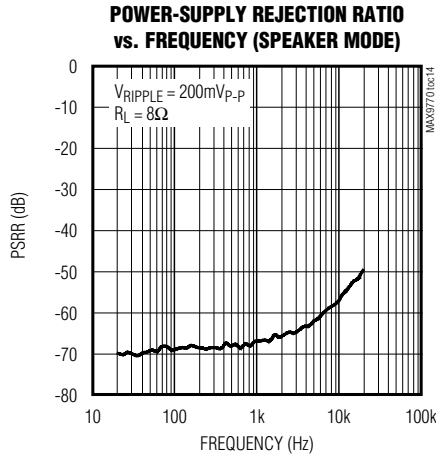
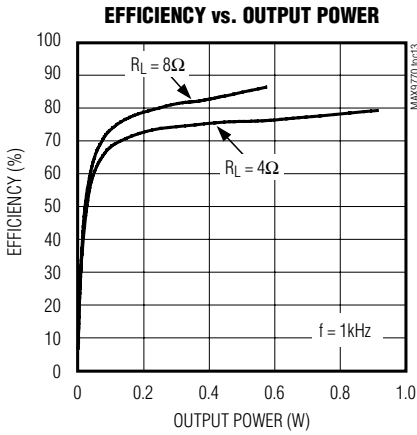
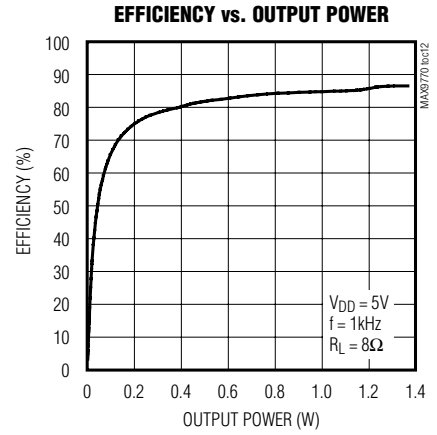
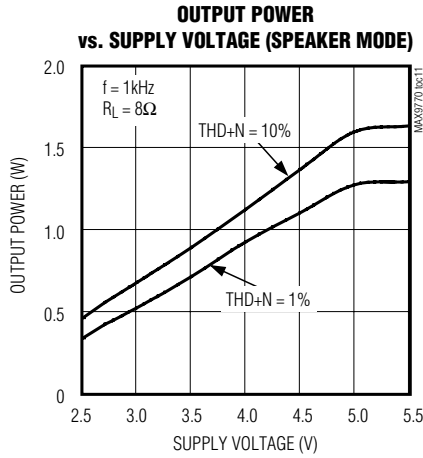
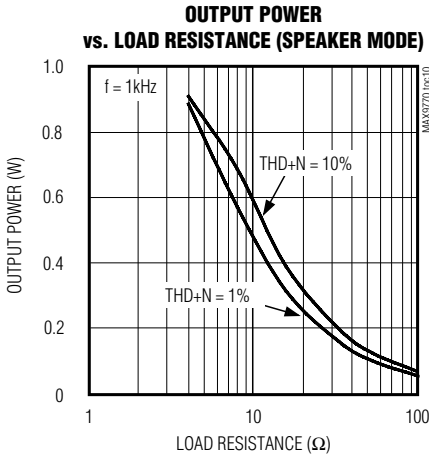

1.2W, Low-EMI, Filterless, Mono Class D Amplifier with Stereo DirectDrive Headphone Amplifiers

MAX9770

Typical Operating Characteristics (continued)

($V_{DD} = 3.3V$, BW = 22Hz to 22kHz, GAIN1 = 1, GAIN2 = 0, spread-spectrum mode, headphone outputs in phase, unless otherwise noted.)

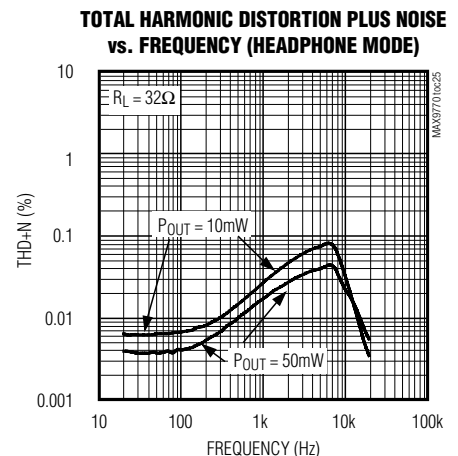
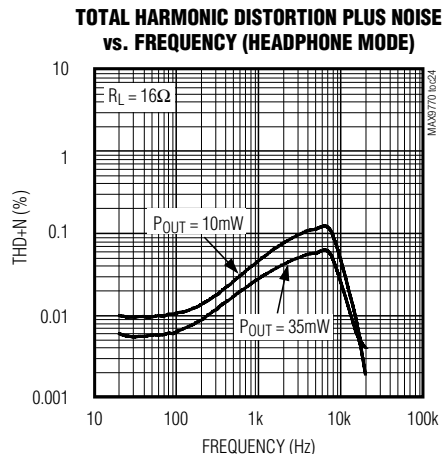
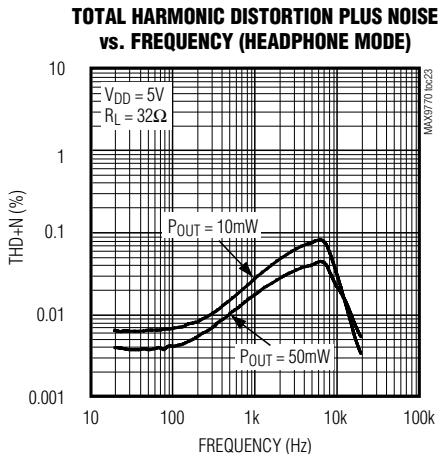
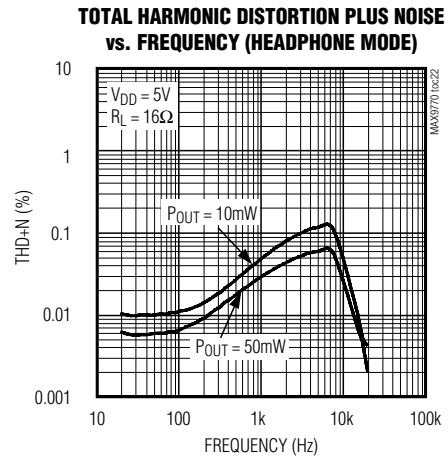
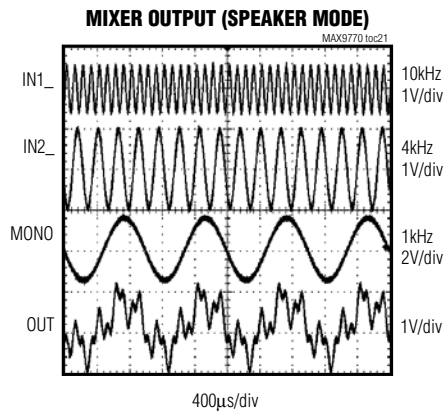
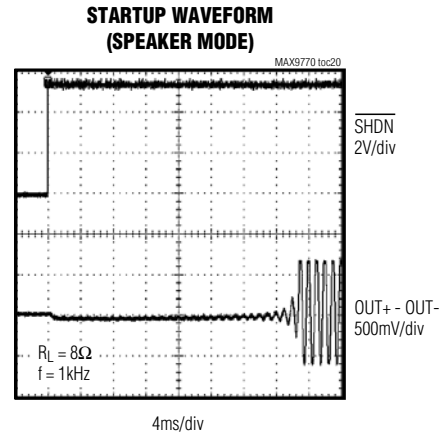
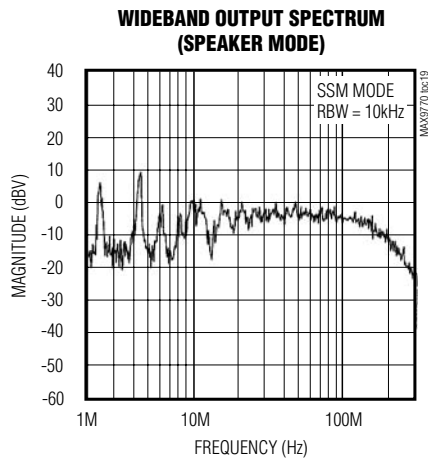

1.2W, Low-EMI, Filterless, Mono Class D Amplifier with Stereo DirectDrive Headphone Amplifiers

Typical Operating Characteristics (continued)

($V_{DD} = 3.3V$, BW = 22Hz to 22kHz, GAIN1 = 1, GAIN2 = 0, spread-spectrum mode, headphone outputs in phase, unless otherwise noted.)

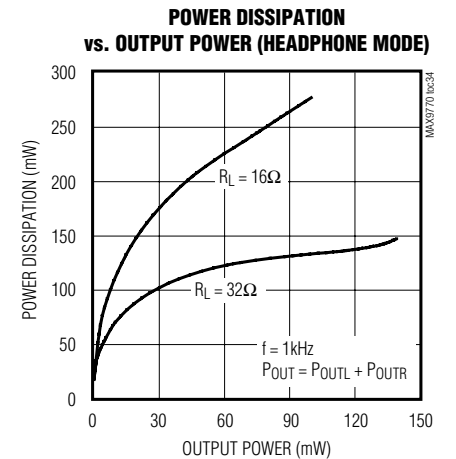
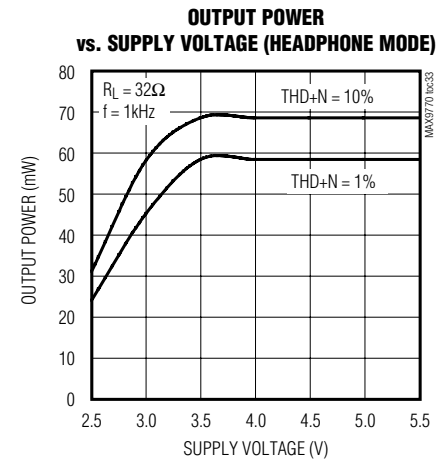
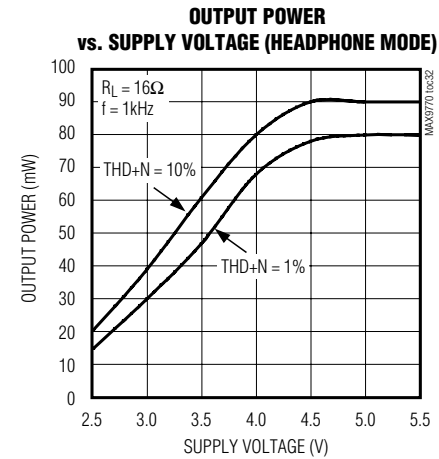
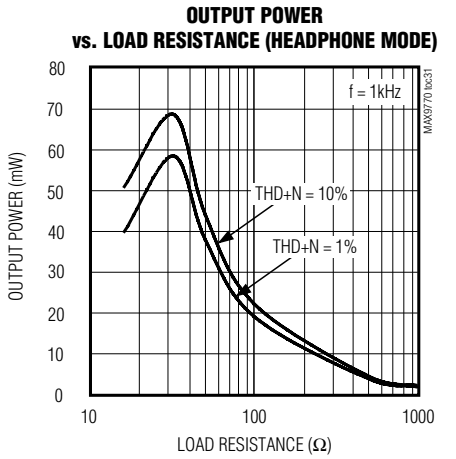
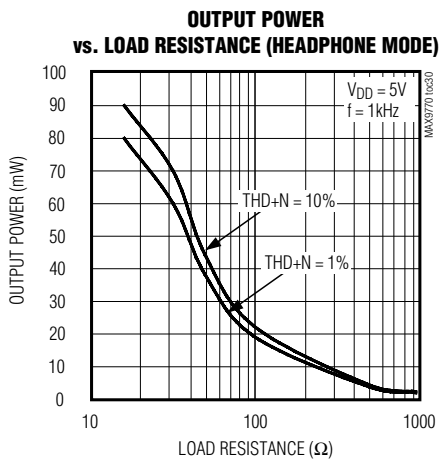
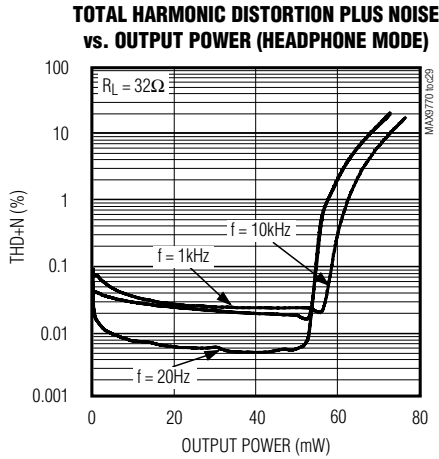
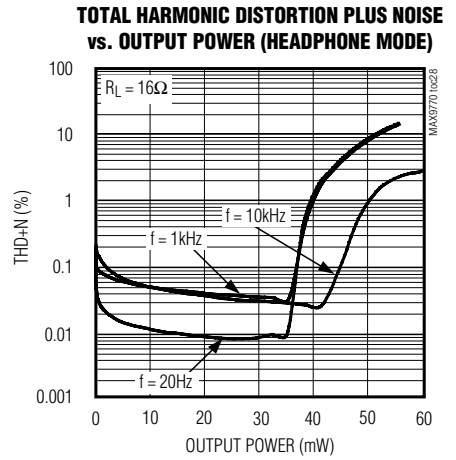
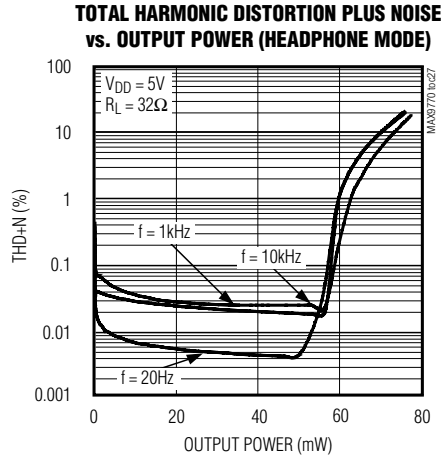
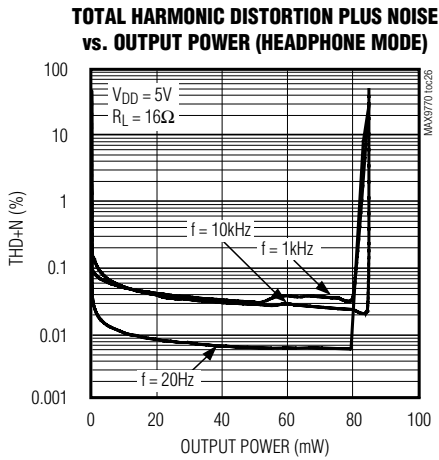

1.2W, Low-EMI, Filterless, Mono Class D Amplifier with Stereo DirectDrive Headphone Amplifiers

MAX9770

Typical Operating Characteristics (continued)

($V_{DD} = 3.3V$, BW = 22Hz to 22kHz, GAIN1 = 1, GAIN2 = 0, spread-spectrum mode, headphone outputs in phase, unless otherwise noted.)

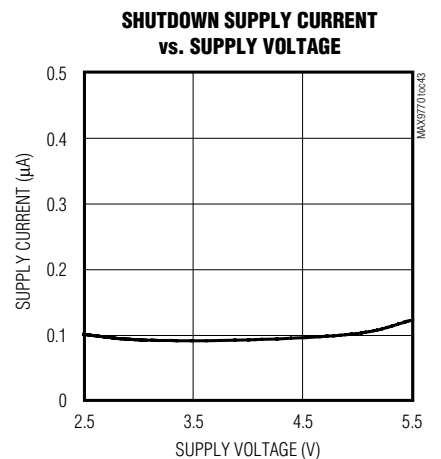
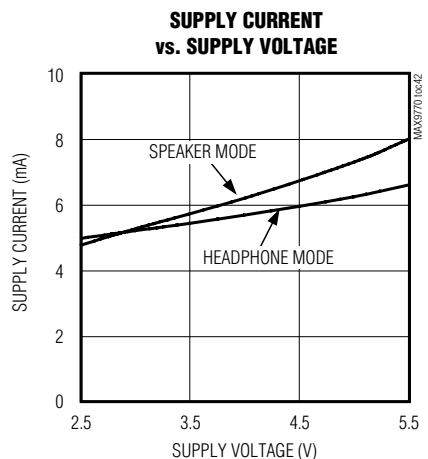
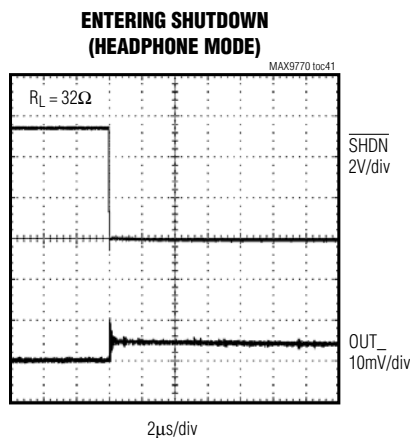
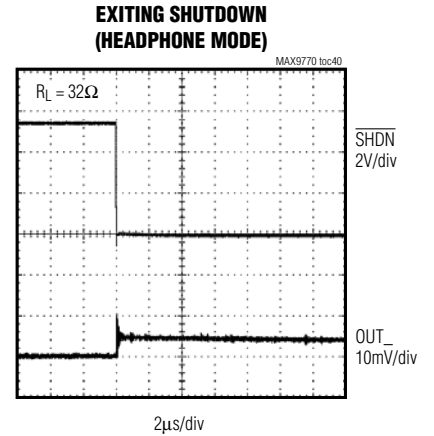
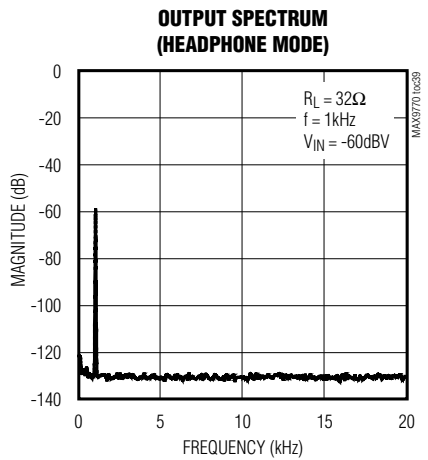
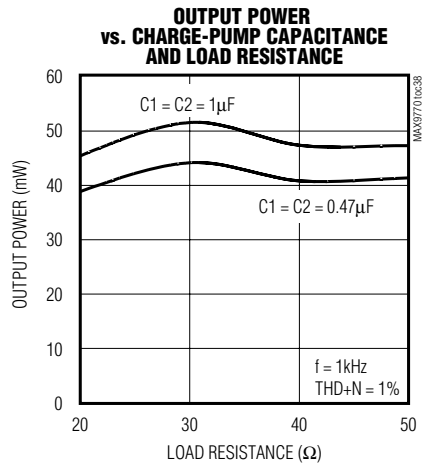
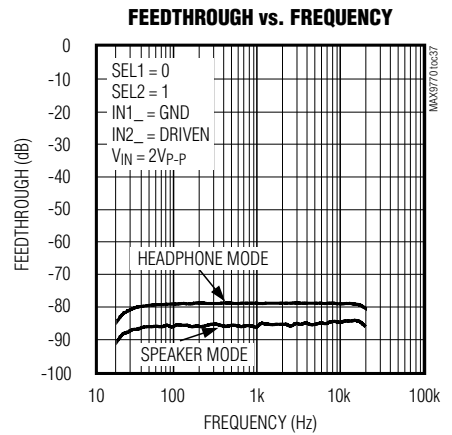
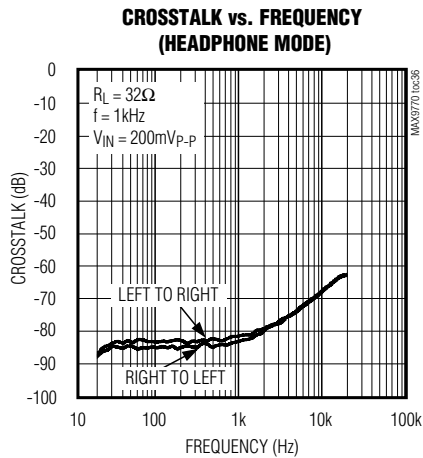
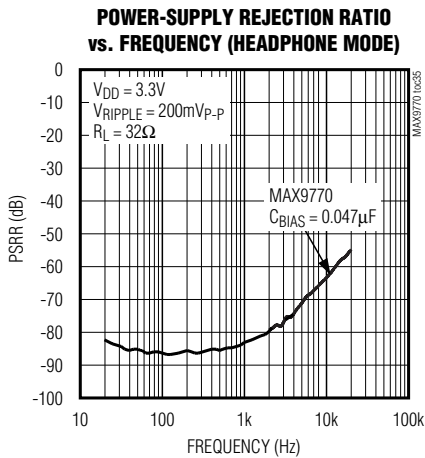

1.2W, Low-EMI, Filterless, Mono Class D Amplifier with Stereo DirectDrive Headphone Amplifiers

Pin Description

PIN		NAME	FUNCTION
TQFN-EP	TSSOP		
1	4	BIAS	Common-Mode Bias Voltage. Bypass with a 0.047 μ F capacitor to GND.
2	5	V _{DD}	Power Supply
3	6	HPOUTR	Right-Channel Headphone Output
4	7	HPOUTL	Left-Channel Headphone Output
5	8	SV _{SS}	Headphone Amplifier Negative Power Supply
6	9	HPS	Headphone Sense Input
7	10	CPV _{DD}	Positive Charge-Pump Power Supply
8	11	CPV _{SS}	Charge-Pump Output. Connect to SV _{SS} .
9	12	C1N	Charge-Pump Flying Capacitor Negative Terminal
10	13	C1P	Charge-Pump Flying Capacitor Positive Terminal
11	14	CPGND	Charge-Pump Ground
12	15	SEL1	Select Stereo Channel 1 Inputs. Digital input. Drive SEL1 high to select inputs IN1L and IN1R.
13	16	SEL2	Select Stereo Channel 2 Inputs. Digital input. Drive SEL2 high to select inputs IN2L and IN2R.
14	17	SELM	Select Mono Channel Input. Digital input. Drive SELM high to select the MONO input.
15	18	$\overline{\text{SHDN}}$	Shutdown. Drive $\overline{\text{SHDN}}$ low to disable the device. Connect $\overline{\text{SHDN}}$ to V _{DD} for normal operation.
16	19	SYNC	Frequency Select and External Clock Input: SYNC = GND: fixed-frequency PWM mode with f _S = 1100kHz. SYNC = Unconnected: fixed-frequency PWM mode with f _S = 1450kHz. SYNC = V_{DD}: spread-spectrum PWM mode with f _S = 1220kHz \pm 120kHz. SYNC = Clocked: fixed-frequency PWM mode with f _S = external clock frequency.
17	20	PGND	Speaker Amplifier Power Ground
18	21	OUT+	Speaker Amplifier Positive Output
19	22	OUT-	Speaker Amplifier Negative Output
20	23	PV _{DD}	Speaker Amplifier Power Supply
21	24	GAIN2	Gain Control Input 2
22	25	GAIN1	Gain Control Input 1
23	26	MONO	Mono Channel Input
24	27	IN2L	Stereo Channel 2, Left Input
25	28	IN1L	Stereo Channel 1, Left Input
26	1	GND	Ground
27	2	IN2R	Stereo Channel 2, Right Input
28	3	IN1R	Stereo Channel 1, Right Input
—	—	EP	Exposed Paddle. Can be left unconnected or connected to GND. Connect to ground plane for improved thermal performance.

1.2W, Low-EMI, Filterless, Mono Class D Amplifier with Stereo DirectDrive Headphone Amplifiers

Detailed Description

The MAX9770 combines a mono 1.2W Class D speaker amplifiers and stereo 80mW DirectDrive headphone amplifiers with integrated headphone sensing and comprehensive click-and-pop suppression. A mixer/multiplexer allows for selection and mixing between two stereo input sources and a single mono source. The MAX9770 features PSRR as high as 85dB, THD as low as 0.015%, industry-leading click-and-pop suppression, and a low-power shutdown mode.

Class D Speaker Amplifier

The MAX9770 Class D amplifier features true filterless, low-EMI, switch-mode architecture that provides Class AB-like performance with Class D efficiency. Comparators monitor the MAX9770 input and compare the input voltage to a sawtooth waveform. The comparators trip when the input magnitude of the sawtooth exceeds the corresponding input voltage. The comparator resets at a fixed time after the rising edge of the

Table 1. Operating Modes

SYNC INPUT	MODE
GND	FFPWM with $f_S = 1100\text{kHz}$
Unconnected	FFPWM with $f_S = 1450\text{kHz}$
V_{DD}	SSPWM with $f_S = 1220\text{kHz} \pm 120\text{kHz}$
Clocked	FFPWM with $f_S = \text{external clock frequency}$

second comparator trip point, generating a minimum-width pulse $t_{ON(MIN)}$ at the output of the second comparator (Figure 1). As the input voltage increases or decreases, the duration of the pulse at one output increases (the first comparator trip point) while the other output pulse duration remains at $t_{ON(MIN)}$. This causes the net voltage across the speaker ($V_{OUT+} - V_{OUT-}$) to change.

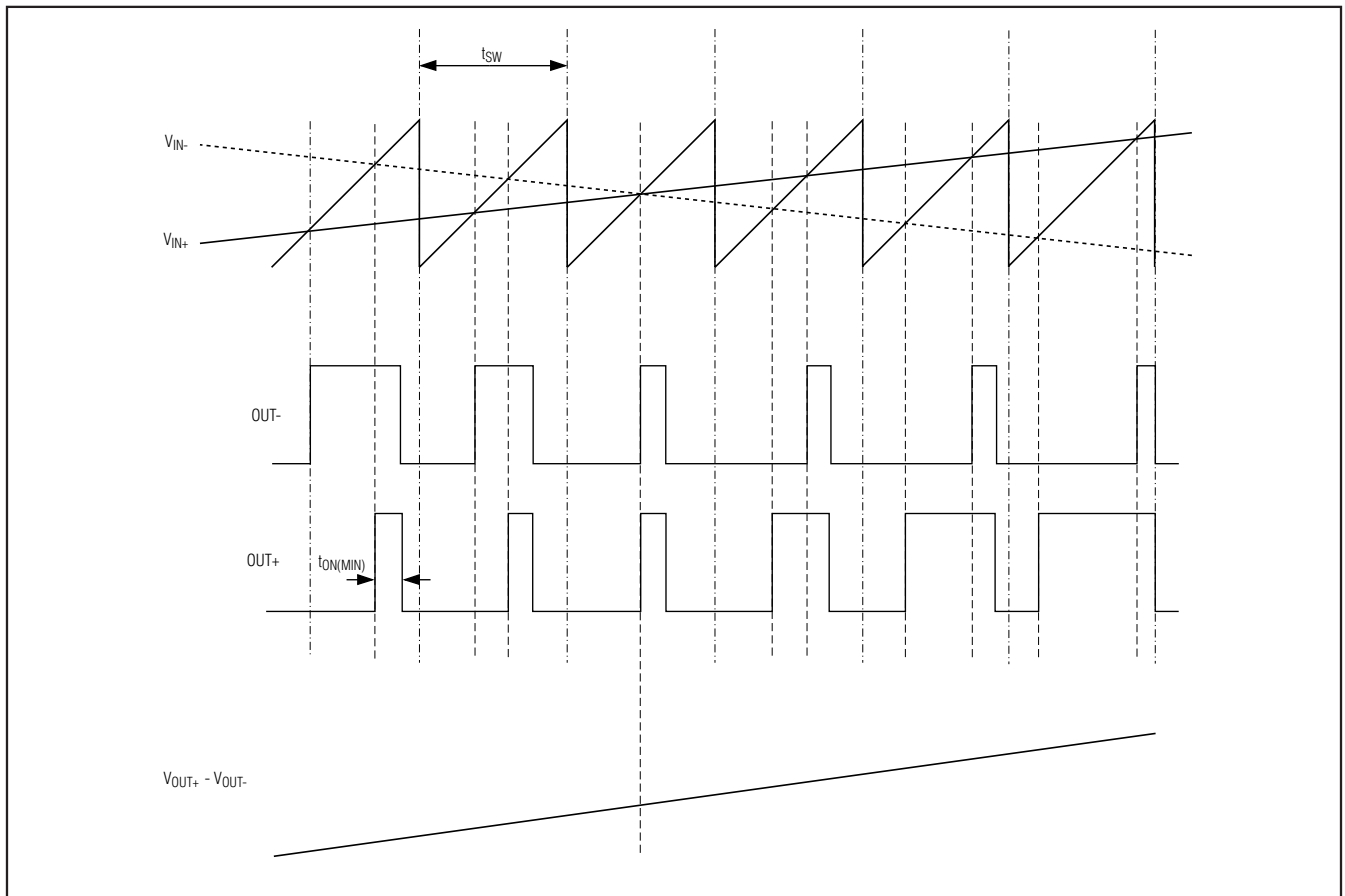

Figure 1. MAX9770 Outputs with an Input Signal Applied

1.2W, Low-EMI, Filterless, Mono Class D Amplifier with Stereo DirectDrive Headphone Amplifiers

Operating Modes

The switching frequency of the charge pump is 1/2 the switching frequency of the Class D amplifier, regardless of the operating mode. When SYNC is driven externally, the charge pump switches at 1/2 f_{SYNC} . When $\text{SYNC} = V_{\text{DD}}$, the charge pump switches with a spread-spectrum pattern.

Fixed-Frequency Modulation (FFM) Mode

The MAX9770 features two FFM modes. The FFM modes are selected by setting $\text{SYNC} = \text{GND}$ for a 1.1MHz switching frequency, and $\text{SYNC} = \text{unconnected}$ for a 1.45MHz switching frequency. In FFM mode, the frequency spectrum of the Class D output consists of the fundamental switching frequency and its associated harmonics (see the Wideband Output Spectrum (Speaker Mode) graph in the *Typical Operating Characteristics*). The MAX9770 allows the switching frequency to be changed by +32% should the frequency of one or more harmonics fall in a sensitive band. This can be done during operation and does not affect audio reproduction.

Spread-Spectrum Modulation (SSM) Mode

The MAX9770 features a unique spread-spectrum mode that flattens the wideband spectral components, improving EMI emissions radiated by the speaker and cables by 5dB. Proprietary techniques ensure that the cycle-to-cycle variation of the switching period does not degrade audio reproduction or efficiency (see the *Typical Operating Characteristics*). Select SSM mode by setting $\text{SYNC} = V_{\text{DD}}$. In SSM mode, the switching frequency varies randomly by $\pm 120\text{kHz}$ around the center frequency (1.22MHz). The modulation scheme remains the same, but the period of the sawtooth waveform changes from cycle-to-cycle (Figure 2). Instead of a large amount of spectral energy present at multiples of the switching frequency, the energy is now spread over a bandwidth that increases with frequency. Above a few MHz, the wideband spectrum looks like white noise for EMI purposes (Figure 3).

External Clock Mode

The SYNC input allows the MAX9770 to be synchronized to a system clock (allowing a fully synchronous system), or allocating the spectral components of the switching harmonics to insensitive frequency bands.

Applying an external clock of 800kHz to 2MHz to SYNC synchronizes the switching frequency of both the Class D and charge pump. The period of the SYNC clock can be randomized, enabling the MAX9770 to be synchronized to another spread-spectrum Class D amplifier operating in SSM mode.

Filterless Modulation/Common-Mode Idle

The MAX9770 uses Maxim's unique modulation scheme that eliminates the LC filter required by traditional Class D amplifiers, improving efficiency, reducing component count, conserving board space and system cost. Conventional Class D amplifiers output a 50% duty cycle square wave when no signal is present. With no filter, the square wave appears across the load as a DC voltage, resulting in finite load current, increasing power consumption. When no signal is present at the device input, the outputs switch as shown in Figure 4. Because the MAX9770 drives the speaker differentially, the two outputs cancel each other, resulting in no net idle mode voltage across the speaker, minimizing power consumption.

Efficiency

The efficiency of a Class D amplifier is attributed to the region of operation of the output stage transistors. In a Class D amplifier, the output transistors act as current-steering switches and consume negligible additional power. Any power loss associated with the Class D output stage is mostly due to the I^2R loss of the MOSFET on-resistance, and quiescent current overhead.

The theoretical best efficiency of a linear amplifier is 78%; however, that efficiency is only exhibited at peak output powers. Under normal operating levels (typical music reproduction levels), efficiency falls below 30%, whereas the MAX9770 still exhibits > 80% efficiencies under the same conditions (Figure 5).

DirectDrive

Traditional single-supply headphone drivers have their outputs biased about a nominal DC voltage (typically half the supply) for maximum dynamic range. Large coupling capacitors are needed to block this DC bias from the headphone. Without these capacitors, a significant amount of DC current flows to the headphone, resulting in unnecessary power dissipation and possible damage to both headphone and headphone driver.

1.2W, Low-EMI, Filterless, Mono Class D Amplifier with Stereo DirectDrive Headphone Amplifiers

MAX9770

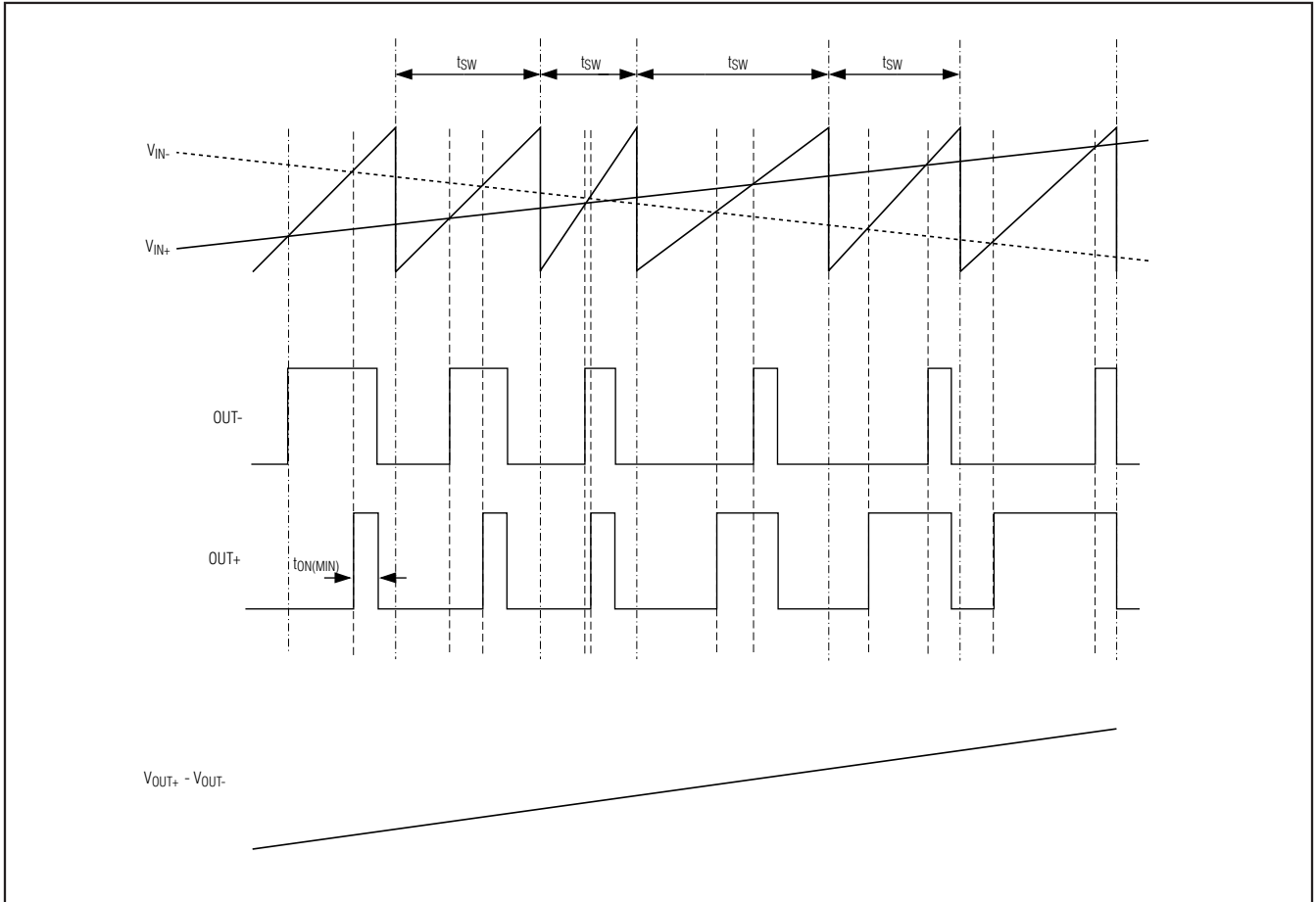

Figure 2. MAX9770 Output with an Input Signal Applied (SSM Mode)

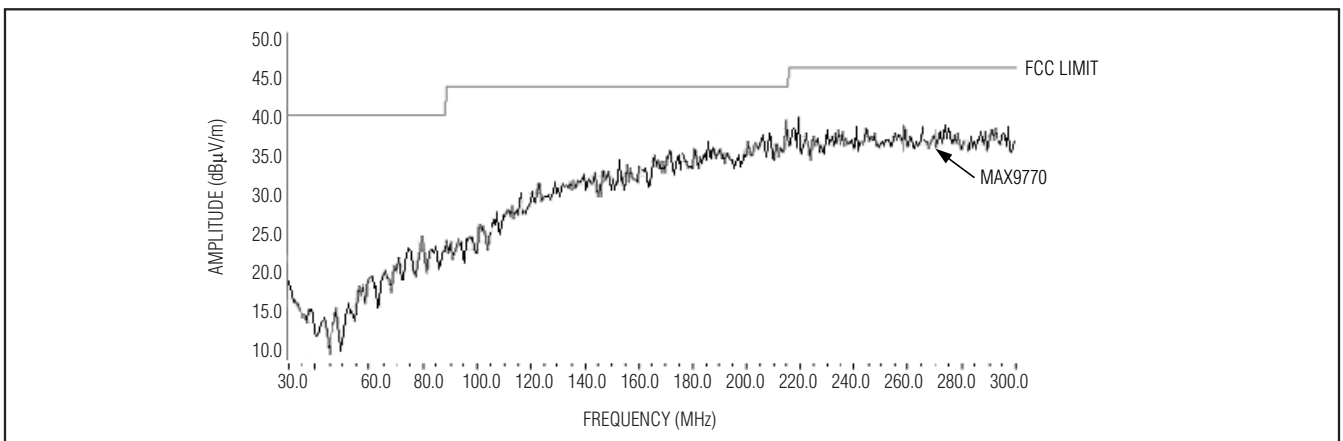

Figure 3. MAX9770 EMI with 75mm of Speaker Cable

1.2W, Low-EMI, Filterless, Mono Class D Amplifier with Stereo DirectDrive Headphone Amplifiers

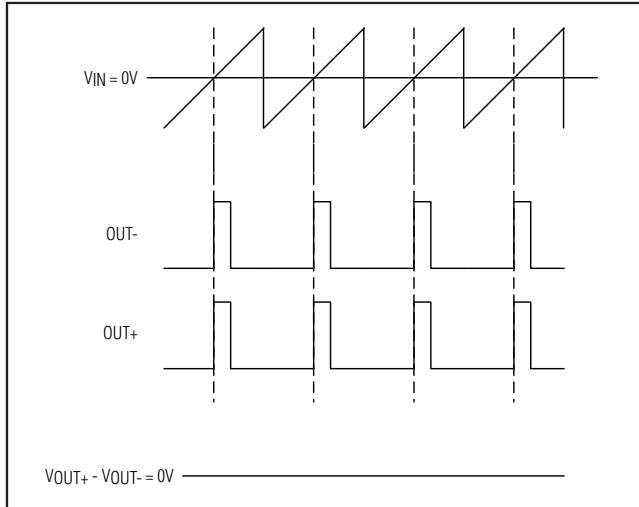

Figure 4. MAX9770 Output with No Signal Applied

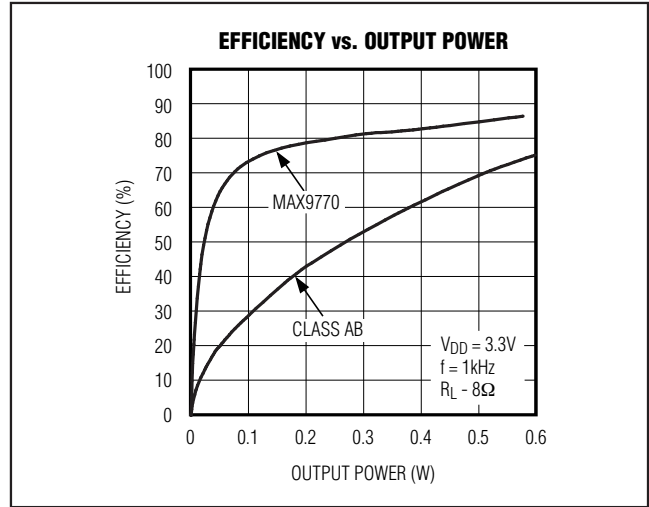

Figure 5. MAX9770 Efficiency vs. Class AB Efficiency

Maxim's DirectDrive architecture uses a charge pump to create an internal negative supply voltage. This allows the headphone outputs of the MAX9770 to be biased about GND, almost doubling dynamic range while operating from a single supply. With no DC component, there is no need for the large DC-blocking capacitors. Instead of two large (220 μ F, typ) tantalum capacitors, the MAX9770 charge pump requires two small ceramic capacitors, which conserves board space, reduces cost, and improves the frequency response of the headphone driver. See the Output Power vs. Charge-Pump Capacitance and Load Resistance graph in the *Typical Operating Characteristics* for details of the possible capacitor sizes. There is a low DC voltage on the driver outputs due to amplifier offset. However, the offset of the MAX9770 is typically 5mV, which, when combined with a 32 Ω load, results in less than 160 μ A of DC current flow to the headphones.

In addition to the cost and size disadvantages of the DC-blocking capacitors required by conventional headphone amplifiers, these capacitors limit the amplifier's low-frequency response and can distort the audio signal.

Previous attempts at eliminating the output-coupling capacitors involved biasing the headphone return (sleeve) to the DC bias voltage of the headphone amplifiers. This method raises some issues:

- 1) When combining a microphone and headphone on a single connector, the microphone bias scheme typically requires a 0V reference.

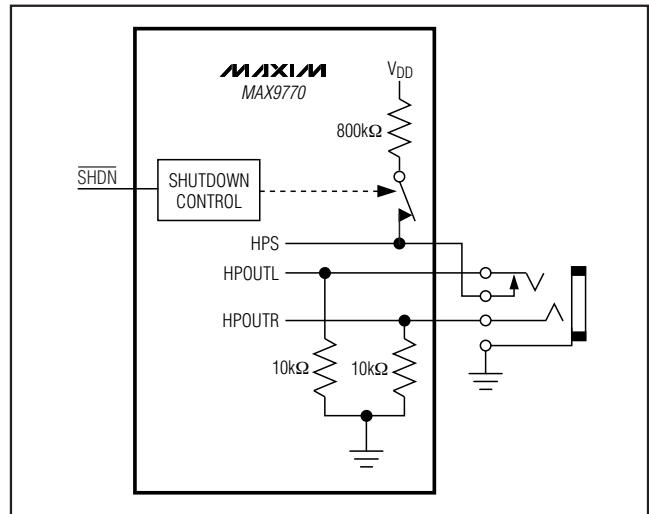

Figure 6. HPS Configuration

- 2) The sleeve is typically grounded to the chassis. Using the midrail biasing approach, the sleeve must be isolated from system ground, complicating product design.
- 3) During an ESD strike, the driver's ESD structures are the only path to system ground. Thus, the driver must be able to withstand the full ESD strike.
- 4) When using the headphone jack as a line out to other equipment, the bias voltage on the sleeve may conflict with the ground potential from other equipment, resulting in possible damage to the drivers.

1.2W, Low-EMI, Filterless, Mono Class D Amplifier with Stereo DirectDrive Headphone Amplifiers

Table 2. MAX9770 Multiplexer/Mixer Settings

SEL1	SEL2	SELM	HEADPHONE MODE		SPEAKER MODE
			HPOUTL	HPOUTR	
0	0	0	MUTE	MUTE	MUTE
1	0	0	IN1L	IN1R	(IN1L + IN1R) / 2
0	1	0	IN2L	IN2R	(IN2L + IN2R) / 2
0	0	1	MONO	MONO	MONO
1	1	0	(IN1L + IN2L) / 2	(IN1R + IN2R) / 2	(IN1L + IN1R + IN2L + IN2R) / 4
1	0	1	(IN1L + MONO) / 2	(IN1R + MONO) / 2	(IN1L + IN1R + MONO x 2) / 4
0	1	1	(IN2L + MONO) / 2	(IN2R + MONO) / 2	(IN2L + IN2R + MONO x 2) / 4
1	1	1	(IN1L + IN2L + MONO) / 3	(IN1R + IN2R + MONO) / 3	(IN1L + IN1R + IN2L + IN2R + MONO x 2) / 6

Charge Pump

The MAX9770 features a low-noise charge pump. The switching frequency of the charge pump is 1/2 the switching frequency of the Class D amplifier, regardless of the operating mode. When SYNC is driven externally, the charge pump switches at 1/2 f_{SYNC} . When SYNC = V_{DD} , the charge pump switches with a spread-spectrum pattern. The nominal switching frequency is well beyond the audio range, and thus does not interfere with the audio signals, resulting in an SNR of 101dB. The switch drivers feature a controlled switching speed that minimizes noise generated by turn-on and turn-off transients. By limiting the switching speed of the charge pump, the di/dt noise caused by the parasitic bond wire and trace inductance is minimized. Although not typically required, additional high-frequency noise attenuation can be achieved by increasing the size of C2 (see the *Block Diagram*). The charge pump is active in both speaker and headphone modes.

Input Multiplexer/Mixer

The MAX9770 features an input multiplexer/mixer that allows multiple audio sources to be selected/mixed. Driving a SEL_ input high selects the input channel (see Table 2), and the audio signal is output to the active amplifier. When a stereo path is selected in speaker mode, the left and right inputs are attenuated by 6dB and mixed together, resulting in a true mono reproduction of a stereo signal. When more than one signal path is selected, the sources are attenuated before mixing to preserve overall amplitude. For example, selecting two sources in headphone mode results in 6dB attenuation of the inputs, while selecting three sources in headphone mode results in 9.5dB attenuation of the inputs. Table 2 shows how the input signals are attenuated and mixed for each possible input selection combination.

Headphone Sense Input (HPS)

The headphone sense input (HPS) monitors the headphone jack, and automatically configures the device based upon the voltage applied at HPS. A voltage of less than 0.8V sets the device to speaker mode. A voltage of greater than 2V disables the bridge amplifiers and enables the headphone amplifiers.

For automatic headphone detection, connect HPS to the control pin of a 3-wire headphone jack as shown in Figure 6. With no headphone present, the output impedance of the headphone amplifier pulls HPS to less than 0.8V. When a headphone plug is inserted into the jack, the control pin is disconnected from the tip contact and HPS is pulled to V_{DD} through the internal 800k Ω pullup. When driving HPS from an external logic source, ground HPS when the MAX9770 is shut down. Place a 10k Ω resistor in series with HPS and the headphone jack to ensure $\pm 8\text{kV}$ ESD protection.

BIAS

The MAX9770 features internally generated, power-supply independent, common-mode bias voltages referenced to GND. BIAS provides both click-and-pop suppression and sets the DC bias level for the amplifiers. Choose the value of the bypass capacitor as described in the *BIAS Capacitor* section. No external load should be applied to BIAS. Any load lowers the BIAS voltage, affecting the overall performance of the device.

Gain Selection

The MAX9770 features logic-selectable, internally set gains. GAIN1 and GAIN2 set the gain of the MAX9770 speaker and headphone amplifiers as shown in Table 3.

The MAX9770 can be configured to automatically switch between two gain settings depending on whether the device is in speaker or headphone mode. By driving one or both gain inputs with HPS, the gain of

1.2W, Low-EMI, Filterless, Mono Class D Amplifier with Stereo DirectDrive Headphone Amplifiers

Table 3. Gain Selection

GAIN1	GAIN2	MAX9770 SPEAKER GAIN (dB)	HEADPHONE GAIN (dB)
0	0	6	7
0	1	3	4
1	0	9	-2
1	1	0	1

Table 4. Gain Settings with HPS Connection

GAIN1	GAIN2	MAX9770 SPEAKER MODE GAIN (HPS = 0) (dB)	HEADPHONE MODE GAIN (HPS = 1) (dB)
HPS	0	6	-2
HPS	1	3	1
0	HPS	6	4
1	HPS	9	1
HPS	HPS	6	1
0	0	6	7
0	1	3	4
1	0	9	-2
1	1	0	1

the device changes when a headphone is inserted or removed. For example, the block diagram shows HPS connected to GAIN2, while GAIN1 is connected to V_{DD}. In this configuration, the gain in speaker mode is 9dB, while the gain in headphone mode is 1dB. The gain settings with the HPS connection are shown in Table 4.

Shutdown

The MAX9770 features a 0.1μA, low-power shutdown mode that reduces quiescent current consumption and extends battery life. Drive $\overline{\text{SHDN}}$ low to disable the drive amplifiers, bias circuitry, and charge pump. Bias is driven to GND and the headphone amplifier output impedance is 10kΩ in shutdown. Connect $\overline{\text{SHDN}}$ to V_{DD} for normal operation.

Click-and-Pop Suppression

Speaker Amplifier

The MAX9770 speaker amplifier features comprehensive click-and-pop suppression that eliminates audible transients on startup and shutdown. While in shutdown, the H-bridge is in a high-impedance state. During start-

up or power-up, the input amplifiers are muted and an internal loop sets the modulator bias voltages to the correct levels, preventing clicks and pops when the H-bridge is subsequently enabled. A soft-start function unmutes the input amplifiers 30ms after startup.

Headphone Amplifier

In conventional single-supply headphone drivers, the output-coupling capacitor is a major contributor of audible clicks and pops. Upon startup, the driver charges the coupling capacitor to its bias voltage, typically half the supply. Likewise, during shutdown, the capacitor is discharged to GND. This results in a DC shift across the capacitor, which in turn, appears as an audible transient at the speaker. Since the MAX9770 headphone amplifier does not require output-coupling capacitors, this does not arise.

Additionally, the MAX9770 features extensive click-and-pop suppression that eliminates any audible transient sources internal to the device. The Exiting Shutdown (Headphone Mode) and Entering Shutdown (Headphone Mode) graphs in the *Typical Operating Characteristics* shows that there are minimal spectral components in the audible range at the output upon startup or shutdown.

In most applications, the output of the preamplifier driving the MAX9770 has a DC bias of typically half the supply. During startup, the input-coupling capacitor is charged to the preamplifier's DC bias voltage through the R_F of the MAX9770, resulting in a DC shift across the capacitor and an audible click-and-pop. An internal delay of 50ms eliminates the click-and-pop caused by the input filter.

Applications Information

Filterless Operation

Traditional Class D amplifiers require an output filter to recover the audio signal from the amplifier's output. The filters add cost, increase the solution size of the amplifier, and can decrease efficiency. The traditional PWM scheme uses large differential output swings (2 x V_{DD} peak-to-peak) at idle and causes large ripple currents. Any parasitic resistance in the filter components results in a loss of power, lowering efficiency.

The MAX9770 does not require an output filter. The device relies on the inherent inductance of the speaker coil and the natural filtering of both the speaker and the human ear to recover the audio component of the square-wave output. Eliminating the output filter results in a smaller, less costly, and more efficient solution.

Because the frequency of the MAX9770 output is well beyond the bandwidth of most speakers, voice coil movement due to the square-wave frequency is minimal.

1.2W, Low-EMI, Filterless, Mono Class D Amplifier with Stereo DirectDrive Headphone Amplifiers

Although this movement is small, a speaker not designed to handle the additional power may be damaged. For optimum results, use a speaker with a series inductance $>10\mu\text{H}$. Typical small 8Ω speakers exhibit series inductances in the range of $20\mu\text{H}$ to $100\mu\text{H}$.

Output Offset

Unlike Class AB amplifiers, the output offset voltage of a Class D amplifier does not noticeably increase quiescent current draw when a load is applied. This is due to the power conversion of the Class D amplifier. For example, a 15mV DC offset across an 8Ω load results in 1.9mA extra current consumption in a Class AB device. In the Class D case, a 15mV offset into 8Ω equates to an additional power drain of $28\mu\text{W}$. Due to the high efficiency of the Class D amplifier, this represents an additional quiescent current draw of $28\mu\text{W}/(V_{\text{DD}} / 100 \times \eta)$, which is on the order of a few microamps.

Power Supplies

The MAX9770 has different supplies for each portion of the device, allowing for the optimum combination of headroom and power dissipation and noise immunity. The speaker amplifier is powered from PV_{DD} . PV_{DD} ranges from 2.5V to 5.5V . The headphone amplifiers are powered from V_{DD} and SV_{SS} . V_{DD} is the positive supply of the headphone amplifiers and ranges from 2.5V to 5.5V . SV_{SS} is the negative supply of the headphone amplifiers. Connect SV_{SS} to CPV_{SS} . The charge pump is powered by CPV_{DD} . CPV_{DD} ranges from 2.5V to 5.5V and should be the same potential as V_{DD} . The charge pump inverts the voltage at CPV_{DD} , and the resulting voltage appears at CPV_{SS} . The remainder of the device is powered by V_{DD} .

Component Selection

Input Filter

The input capacitor (C_{IN}), in conjunction with the amplifier input resistance (R_{IN}), forms a highpass filter that removes the DC bias from an incoming signal (see the *Block Diagram*). The AC-coupling capacitor allows the amplifier to bias the signal to an optimum DC level. Assuming zero-source impedance, the -3dB point of the highpass filter is given by:

$$f_{-3\text{dB}} = \frac{1}{2\pi R_{\text{IN}} C_{\text{IN}}}$$

R_{IN} is the amplifier's internal input resistance value given in the *Electrical Characteristics*. Be aware that the MONO input has a lower input impedance than the other inputs. Choose C_{IN} such that $f_{-3\text{dB}}$ is below the lowest frequency of interest. Setting $f_{-3\text{dB}}$ too high

affects the amplifier's low-frequency response. Setting $f_{-3\text{dB}}$ too low can affect the click-and-pop performance. Use capacitors with low-voltage coefficient dielectrics, such as tantalum or aluminum electrolytic. Capacitors with high-voltage coefficients, such as ceramics, may result in increased distortion at low frequencies.

Output Filter

The MAX9770 speaker amplifier does not require an output filter for normal operation and audio reproduction. The device passes FCC Class B radiated emissions standards with 100mm of unshielded speaker cables. However, output filtering can be used if a design is failing radiated emissions due to board layout or cable length, or if the circuit is near EMI-sensitive devices. Use a common-mode choke connected in series with the speaker outputs if board space is limited and emissions are a concern. Use of an LC filter is necessary if excessive speaker cable is used.

BIAS Capacitor

BIAS is the output of the internally generated DC bias voltage. The BIAS bypass capacitor, C_{BIAS} improves PSRR and THD+N by reducing power supply and other noise sources at the common-mode bias node, and also generates the clickless/popless, startup/shutdown DC bias waveforms for the speaker amplifiers. Bypass BIAS with a $0.047\mu\text{F}$ capacitor to GND.

1.2W, Low-EMI, Filterless, Mono Class D Amplifier with Stereo DirectDrive Headphone Amplifiers

Table 5. Suggested Capacitor Manufacturers

SUPPLIER	PHONE	FAX	WEBSITE
Taiyo Yuden	800-348-2496	847-925-0899	www.t-yuden.com
TDK	807-803-6100	847-390-4405	www.component.tdk.com

Charge-Pump Capacitor Selection

Use capacitors with an ESR less than 100mΩ for optimum performance. Low-ESR ceramic capacitors minimize the output resistance of the charge pump. Most surface-mount ceramic capacitors satisfy the ESR requirement. For best performance over the extended temperature range, select capacitors with an X7R dielectric. Table 5 lists suggested manufacturers.

Flying Capacitor (C1)

The value of the flying capacitor (C1) affects the load regulation and output resistance of the charge pump. A C1 value that is too small degrades the device's ability to provide sufficient current drive, which leads to a loss of output voltage. Increasing the value of C1 may improve load regulation and reduces the charge-pump output resistance to an extent. Above 1μF, the on-resistance of the switches and the ESR of C1 and C2 dominate.

Output Capacitor (C2)

The output capacitor value and ESR directly affect the ripple at CPV_{SS}. Increasing the value of C2 reduces output ripple. Likewise, decreasing the ESR of C2 reduces both ripple and output resistance. Lower capacitance values can be used in systems with low maximum output power levels. See the Output Power vs. Charge-Pump Capacitance and Load Resistance graph in the *Typical Operating Characteristics*.

CPV_{DD} Bypass Capacitor

The CPV_{DD} bypass capacitor (C3) lowers the output impedance of the power supply and reduces the impact of the MAX9770's charge-pump switching transients. Bypass CPV_{DD} with C3, the same value as C1, and place it physically close to the CPV_{DD} and PGND (refer to the MAX9770 EV kit for a suggested layout).

Layout and Grounding

Proper layout and grounding are essential for optimum performance. Use large traces for the power-supply inputs and amplifier outputs to minimize losses due to

parasitic trace resistance, as well as route the head away from the device. Good grounding improves audio performance, minimizes crosstalk between channels, and prevents any switching noise from coupling into the audio signal. Connect CPGND, PGND, and GND together at a single point on the PC board. Route CPGND and all traces that carry switching transients away from GND, PGND, and the traces and components in the audio signal path.

Connect all components associated with the charge pump (C2 and C3) to the CPGND plane. Connect SV_{SS} and CPV_{SS} together at the device. Place the charge-pump capacitors (C1, C2, and C3) as close to the device as possible. Bypass V_{DD} and PV_{DD} with a 1μF capacitor to GND. Place the bypass capacitors as close to the device as possible.

Use large, low-resistance output traces. As load impedance decreases, the current drawn from the device outputs increase. At higher current, the resistance of the output traces decrease the power delivered to the load. Large output, supply, and GND traces also improve the power dissipation of the device.

The MAX9770 thin QFN package features an exposed thermal pad on its underside. This pad lowers the package's thermal resistance by providing a direct heat conduction path. Due to the high efficiency of the MAX9770's Class D amplifier, additional heatsinking is not required. If additional heatsinking is required, connect the exposed paddle to GND. See the MAX9770 EV kit data sheet for suggested component values and layout guidelines.

1.2W, Low-EMI, Filterless, Mono Class D Amplifier with Stereo DirectDrive Headphone Amplifiers

Block Diagram

MAX9770

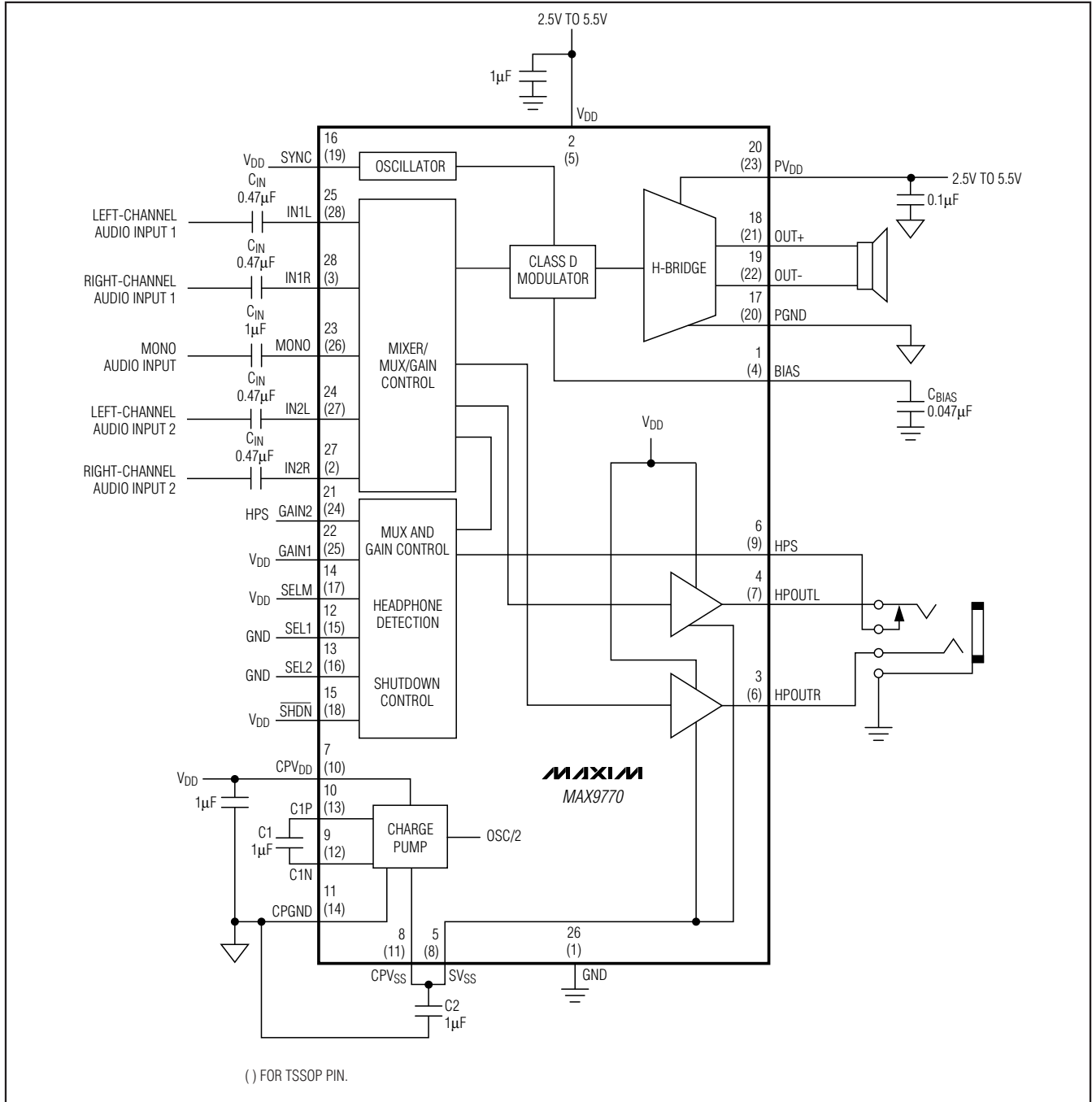

1.2W, Low-EMI, Filterless, Mono Class D Amplifier with Stereo DirectDrive Headphone Amplifiers

System Diagram

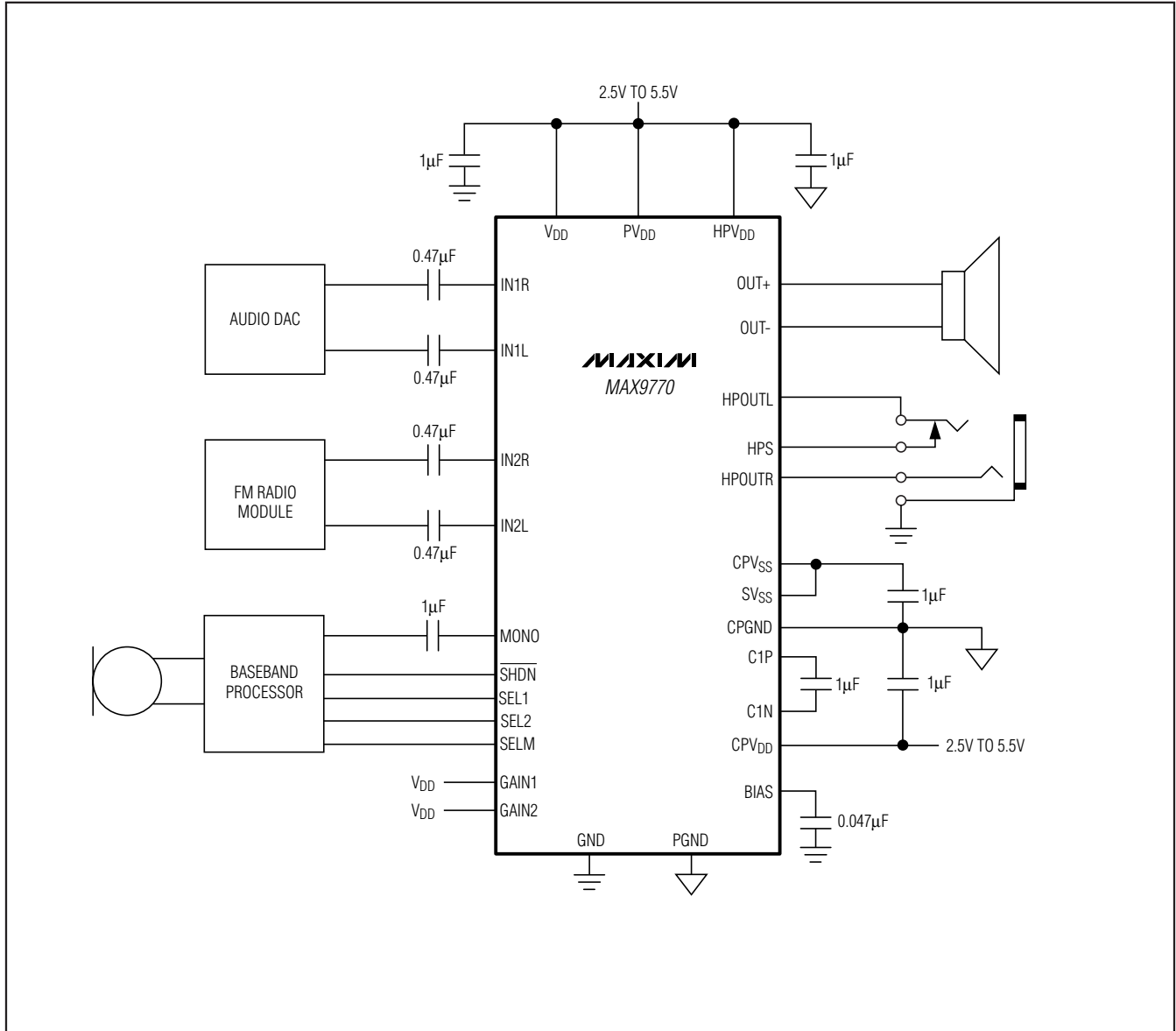

1.2W, Low-EMI, Filterless, Mono Class D Amplifier with Stereo DirectDrive Headphone Amplifiers

Pin Configurations

MAX9770

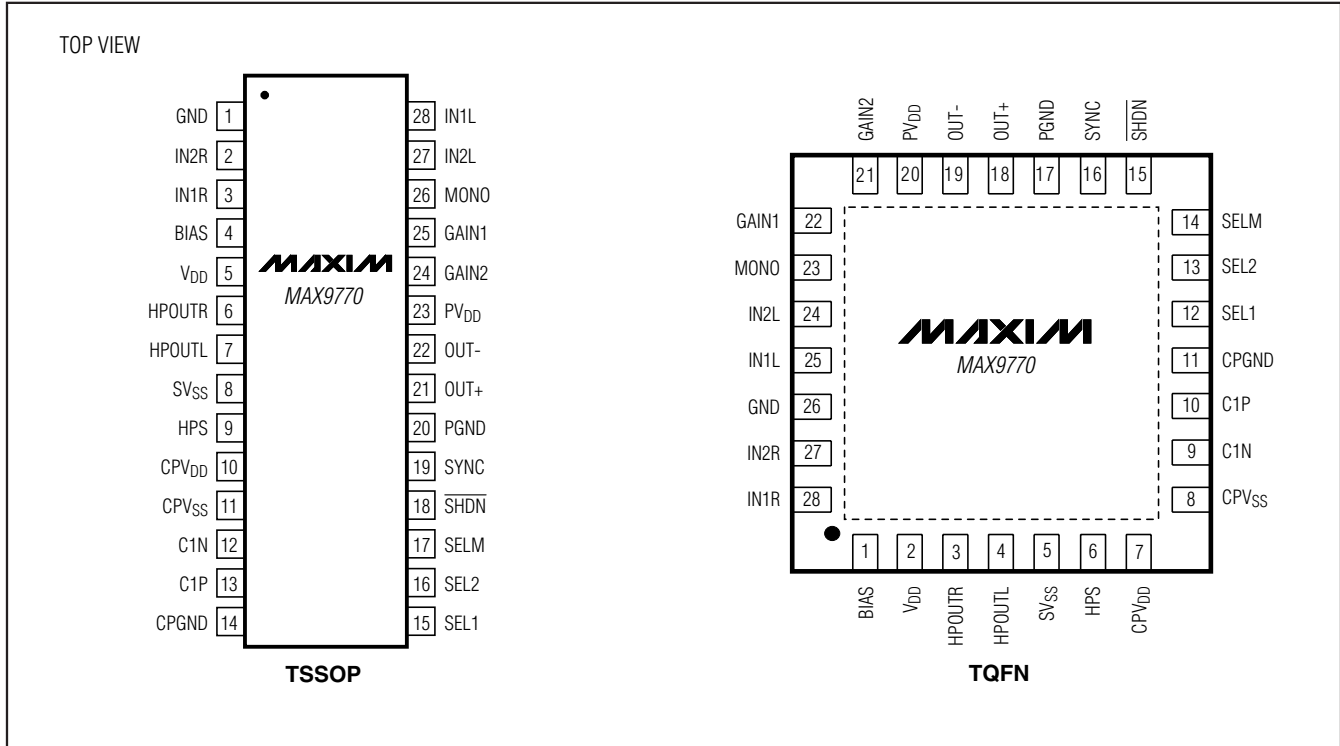

Chip Information

TRANSISTOR COUNT: 7020
PROCESS: BICMOS

Package Information

For the latest package outline information, go to www.maxim-ic.com/packages.

PACKAGE TYPE	PACKAGE CODE	DOCUMENT NO.
28 TQFN-EP	T2855N-1	21-0140
28 TSSOP	U28-1	21-0066

MAX9770

1.2W, Low-EMI, Filterless, Mono Class D Amplifier with Stereo DirectDrive Headphone Amplifiers

Revision History

REVISION NUMBER	REVISION DATE	DESCRIPTION	PAGES CHANGED
2	4/08	Removing MAX9772 from data sheet	1-21

Maxim cannot assume responsibility for use of any circuitry other than circuitry entirely embodied in a Maxim product. No circuit patent licenses are implied. Maxim reserves the right to change the circuitry and specifications without notice at any time.

22 _____ **Maxim Integrated Products, 120 San Gabriel Drive, Sunnyvale, CA 94086 408-737-7600**

© 2008 Maxim Integrated Products

MAXIM is a registered trademark of Maxim Integrated Products, Inc.

Looking for pricing, stock, or lifecycle information?

Click below to explore more details on WIN SOURCE:

 [View MAX9770EUI+ on WIN SOURCE](#)

 [Maxim Integrated](#) Information

Optimize Your Supply Chain with WIN SOURCE Solutions

-  Global Sourcing Solution
-  Obsolete Management
-  Cost Control Management
-  Shortage Management
-  Alternative Solution
-  Excess Inventory Management