



**THE DATASHEET OF  
MAX6806UR46+T**



# MAX6806/MAX6807/ MAX6808

## Voltage Detectors

### General Description

The MAX6806/MAX6807/MAX6808 precision voltage detectors are ideal for accurate monitoring of power supplies in digital systems. They provide circuit reliability and reduce total cost by eliminating external components and adjustments.

The MAX6806/MAX6807/MAX6808 assert a reset signal whenever the supply voltage ( $V_{CC}$ ) falls below the factory-preset,  $\pm 2\%$  accurate threshold. Internal hysteresis ensures stable switching. The MAX6806/MAX6807/MAX6808 are available in 4.6V and 2.6V thresholds (2.3V is also available for the MAX6806 only). The MAX6806 features an active-low, push-pull  $\overline{\text{RESET}}$  output; the MAX6807 features an active-high, push-pull RESET output; and the MAX6808 features an active-low, open-drain  $\overline{\text{RESET}}$  output.  $\overline{\text{RESET}}$  is valid for  $V_{CC}$  down to 1V (MAX6806/MAX6808), and RESET (MAX6807) is guaranteed for  $V_{CC}$  down to 1.2V.

The MAX6806/MAX6807/MAX6808 are available in 3-pin SC70, 3-pin SOT23, 8-pin  $\mu\text{MAX}$ , 8-pin SO, and 4-pin SOT143 packages. The SOT143 package includes a manual-reset input.

### Applications

- Computers
- Controllers
- Intelligent Instruments
- Critical  $\mu\text{P}$  and  $\mu\text{C}$  Power Monitoring
- Portable/Battery-Powered Equipment
- Bar-Code Scanners

**Selector Guide and Pin Configurations appear at end of data sheet.**

### Typical Operating Circuit

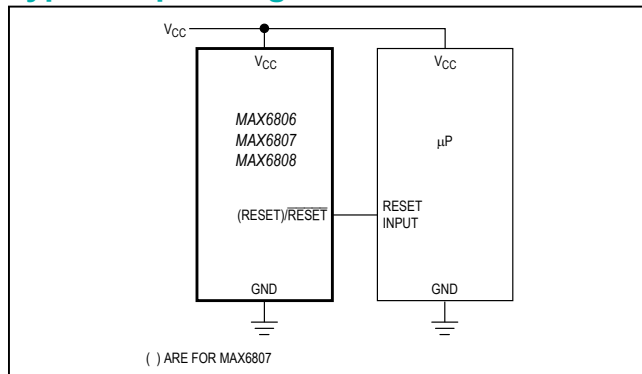

### Features

- Preset Reset Thresholds: 4.6V and 2.6V (2.3V also available for MAX6806 only)
- $\pm 2\%$  Accurate Reset Thresholds
- Reset Output Available in Active-Low (MAX6806), Active-High (MAX6807), and Open-Drain (MAX6808) Versions
- Immune to Power-Supply Transients
- $\overline{\text{RESET}}$  Valid to  $V_{CC} = 1.0\text{V}$  (MAX6806/MAX6808)
- 35 $\mu\text{A}$  Supply Current
- No External Components
- Manual Reset Available with 4-Pin SOT143 Package
- Miniature 3-Pin SC70, 3-Pin SOT23, and 4-Pin SOT143 Packages
- 8-Pin  $\mu\text{MAX}$  and 8-Pin SO Packages are Pin Compatible with the MC33064/MC33164/MC34064/MC34164

### Ordering Information

PART	TEMP. RANGE	PIN-PACKAGE
<b>MAX6806</b> XR__-T	-40°C to +85°C	3 SC70
MAX6806UR__-T	-40°C to +85°C	3 SOT23
MAX6806US__-T	-40°C to +85°C	4 SOT143
MAX6806UA__	-40°C to +85°C	8 $\mu\text{MAX}$
MAX6806SA__	-40°C to +85°C	8 SO
<b>MAX6807</b> XR__-T	-40°C to +85°C	3 SC70
MAX6807UR__-T	-40°C to +85°C	3 SOT23
MAX6807US__-T	-40°C to +85°C	4 SOT143
MAX6807UA__	-40°C to +85°C	8 $\mu\text{MAX}$
MAX6807SA__	-40°C to +85°C	8 SO
<b>MAX6808</b> XR__-T	-40°C to +85°C	3 SC70
MAX6808UR__-T	-40°C to +85°C	3 SOT23
MAX6808US__-T	-40°C to +85°C	4 SOT143
MAX6808UA__	-40°C to +85°C	8 $\mu\text{MAX}$
MAX6808SA__	-40°C to +85°C	8 SO

\* SOT23, SOT143, and SC70s are available in tape-and-reel only, 2500 piece minimum order quantity.

**Note:** Insert the desired number from the Selector Guide into the blank to complete the part number. Also see Selector Guide for top mark for SOT23

**Absolute Maximum Ratings**

V<sub>CC</sub> to GND .....-0.3V to +6.0V  
 RESET,  $\overline{\text{RESET}}$  to GND  
 (MAX6806/MAX6807) .....-0.3V to (V<sub>CC</sub> + 0.3V)  
 RESET to GND (MAX6808) .....-0.3V to + 6.0V  
 MR to GND (SOT143 package only) .....-0.3V to + 6.0V  
 Input Current, V<sub>CC</sub> .....±20mA  
 Output Current, RESET,  $\overline{\text{RESET}}$  .....±20mA  
 Rate of Rise, V<sub>CC</sub> .....100V/μs

Continuous Power Dissipation (T<sub>A</sub> = +70°C)  
 SOT23, SOT143 (derate 4mW/°C above +70°C) .....320mW  
 SC70 (derate 2.17mW/°C above +70vC) .....174mW  
 μMAX (derate 4.5mW/°C above +70°C) .....362mW  
 SO (derate 5.9mW/°C above +70°C) .....471mW  
 Operating Temperature Range .....-40°C to +85°C  
 Storage Temperature Range .....-65°C to +160°C  
 Lead Temperature (soldering, 10s) .....+300°C

*Stresses beyond those listed under "Absolute Maximum Ratings" may cause permanent damage to the device. These are stress ratings only, and functional operation of the device at these or any other conditions beyond those indicated in the operational sections of the specifications is not implied. Exposure to absolute maximum rating conditions for extended periods may affect device reliability.*

**Electrical Characteristics**

(V<sub>CC</sub> = +5V, T<sub>A</sub> = -40°C to +85°C, unless otherwise noted. Typical values are at T<sub>A</sub> = +25°C.) (Note 1)

PARAMETER	SYMBOL	CONDITIONS	MIN	TYP	MAX	UNITS	
Supply Voltage Range	V <sub>CC</sub>	TA = 0°C to +70°C	1.0		5.5	V	
		TA = -40°C to +85°C	1.2		5.5		
Supply Current	I <sub>CC</sub>	V <sub>CC</sub> = +3.6V, no load		35	60	μA	
		V <sub>CC</sub> = +5.5V, no load		50	80		
Reset Threshold	V <sub>TH-</sub>	TA = +25°C V <sub>CC</sub> falling	MAX680__ _46	4.508	4.60	4.692	V
			MAX680__ _32	3.136	3.20	3.264	
			MAX680__ _26	2.548	2.60	2.652	
			MAX680__ _23	2.254	2.30	2.346	
Reset Threshold Hysteresis	V <sub>HYST</sub>	TA = +25°C, Figure 2		0.02 V <sub>TH-</sub>	0.03 V <sub>TH-</sub>	V	
RESET Output Voltage (MAX6806/MAX6808)	V <sub>OL</sub>	ISINK = 20μA, V <sub>CC</sub> = 1.0V			0.3	V	
	V <sub>OL</sub>	ISINK = 1.0mA, V <sub>CC</sub> = 2.0V			0.4		
	V <sub>OH</sub>	ISOURCE = 2.0mA, V <sub>CC</sub> = 5.0V (MAX6806 only)	0.8 V <sub>CC</sub>				
RESET Output Leakage Current	I <sub>OH</sub>	V <sub>CC</sub> = 5.5V, RESET deasserted (MAX6808 only)			1	μA	
RESET Output Voltage (MAX6807)	V <sub>OH</sub>	ISOURCE = 20μA, V <sub>CC</sub> = 1.2V	0.8 V <sub>CC</sub>			V	
	V <sub>OH</sub>	ISOURCE = 400μA, V <sub>CC</sub> = 2.0V	0.8 V <sub>CC</sub>				
	V <sub>OL</sub>	ISINK = 3.2mA, V <sub>CC</sub> = 5.0V			0.4		
V <sub>CC</sub> to Reset Delay (Note 2)		V <sub>CC</sub> falling at 1mV/μs		30		μs	
Reset Threshold Tempco				30		ppm/°C	
MR Pulldown Resistance	R <sub>MR</sub>		40	80	120	kΩ	
MR Input Threshold	V <sub>IL</sub>	V <sub>CC</sub> > V <sub>TH+</sub>			0.6	V	
	V <sub>IH</sub>		0.7 V <sub>CC</sub>				

Note1: All devices are 100% production tested at T<sub>A</sub> = +25°C, and are guaranteed by design for T<sub>A</sub> = T<sub>MIN</sub> to T<sub>MAX</sub>, as specified.  
 Note 2:  $\overline{\text{RESET}}$  output for MAX6806/MAX6808, RESET output for MAX6807.

Typical Operating Characteristics

(T<sub>A</sub> = +25°C, unless otherwise noted.)

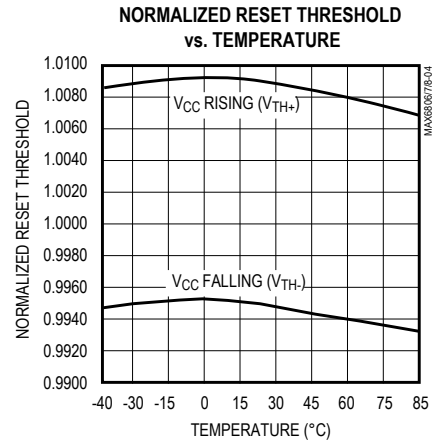
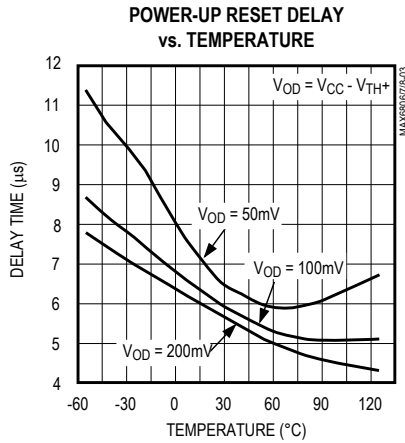
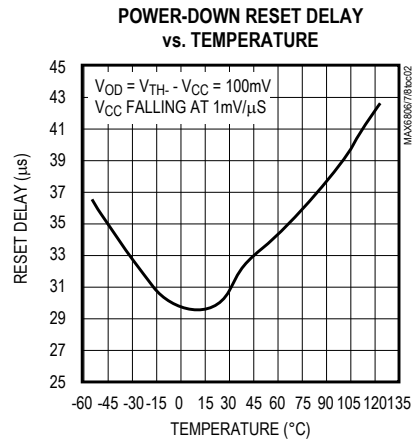
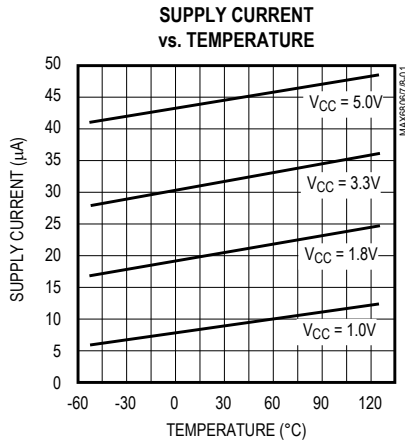

Pin Description

PIN			NAME	FUNCTION
SOT23/SC70	SOT143	µMAX/SO		
1	1	1	$\overline{\text{RESET}}$	Active-Low Reset Output (MAX6806/MAX6808). $\overline{\text{RESET}}$ remains low while V <sub>CC</sub> is below the reset-threshold voltage or while MR is held high.
			RESET	Active-High Reset Output (MAX6807). RESET remains high while V <sub>CC</sub> is below the reset-threshold voltage or while MR is held high.
2	4	4	GND	Ground
3	3	2	VCC	Supply Voltage Input
—	2	—	MR	Active-High Manual Reset Input. Internal 80kΩ resistor to GND.
—	—	3,5–8	N.C.	Not Internally Connected

## Detailed Description

### Reset Output

The MAX6806 voltage detector features an active-low, push-pull  $\overline{\text{RESET}}$  output, while the MAX6807 features an active-high, push-pull  $\text{RESET}$  output. Unlike microprocessor ( $\mu\text{P}$ ) supervisory circuits that offer a reset timeout period, the MAX6806 and MAX6807  $\overline{\text{RESET}}$  goes high and  $\text{RESET}$  goes low virtually immediately once  $V_{\text{CC}}$  exceeds the reset threshold. If a brownout occurs ( $V_{\text{CC}}$  falls below the reset threshold),  $\overline{\text{RESET}}$  goes low and  $\text{RESET}$  goes high.  $\overline{\text{RESET}}$  is guaranteed to be a logic low for  $V_{\text{CC}} \geq 1\text{V}$  and  $\text{RESET}$  is guaranteed to be a logic high for  $V_{\text{CC}} \geq 1.2\text{V}$ .

The MAX6808 features an active-low, open-drain  $\overline{\text{RESET}}$  output. The output sinks current when  $V_{\text{CC}}$  falls below the reset threshold. Connect a pullup resistor from  $\overline{\text{RESET}}$  to any supply voltage up to 6V (Figure 1). Select a resistor value large enough to provide a logic low and small enough to provide a logic high while supplying all input and leakage currents connected to the  $\overline{\text{RESET}}$  line. A 100k $\Omega$  resistor is sufficient in applications driving high-impedance loads.

The manual reset input (MR, 4-pin SOT143 package) can also initiate a reset (see Manual Reset Input section).

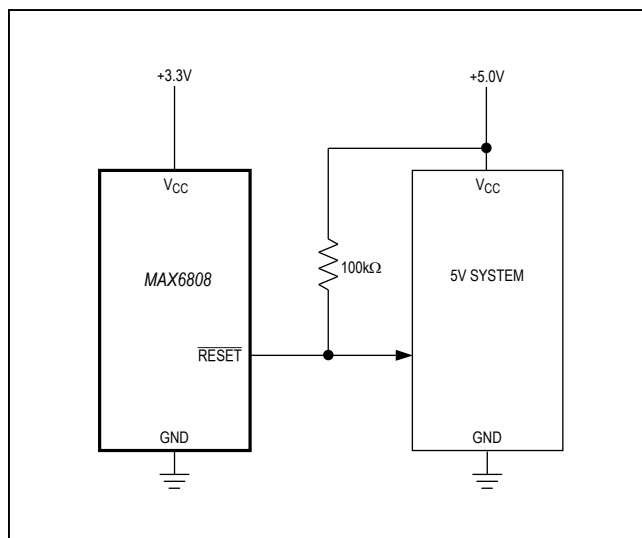

Figure 1. The MAX6808 Open-Drain  $\overline{\text{RESET}}$  Output Allows Use with Multiple Supplies

### Manual-Reset Input

Many applications require manual-reset capabilities, allowing an operator, a test technician, or external logic circuitry to initiate a reset. A logic high on MR asserts a reset and remains asserted while MR is high. This input has an 80k $\Omega$  pulldown resistor, so the input can be left unconnected if not used. Connect a normally open momentary switch from MR to  $V_{\text{CC}}$  to create a manual-reset function. If MR is driven from long cables or if the device is used in a noisy environment, connecting a 0.1 $\mu\text{F}$  capacitor from MR to ground provides noise immunity.

### Hysteresis

The MAX6806/MAX6807/MAX6808 feature internal hysteresis that creates two trip points: one for the rising supply voltage and one for the falling supply voltage (Figure 2). The hysteresis prevents the output from oscillating (chattering) when  $V_{\text{CC}}$  is near the reset threshold.

### Reset Threshold Accuracy

The MAX6806/MAX6807/MAX6808 are ideal for systems using a 5V  $\pm 5\%$ , 3V  $\pm 5\%$ , or 2.5V  $\pm 5\%$  power supply with ICs specified for 5V  $\pm 10\%$ , 3V  $\pm 10\%$ , or 2.5V  $\pm 10\%$ , respectively. The reset is guaranteed to assert after the power supply falls out of regulation, but before power drops below the minimum specified operating voltage range for the system ICs.

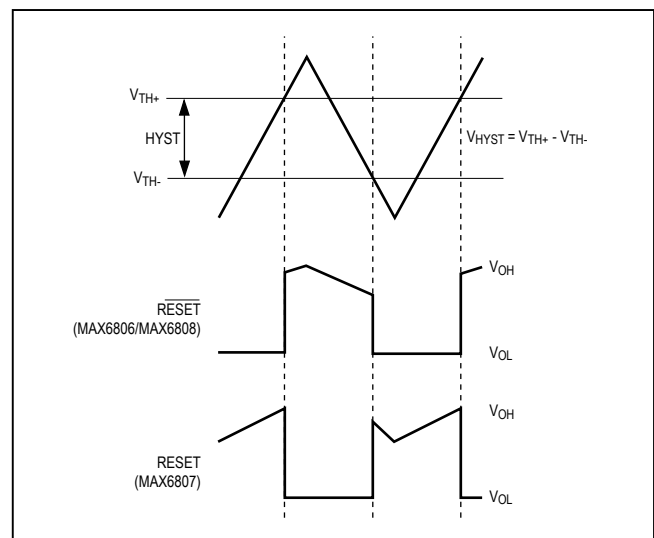

Figure 2. Input and Output Waveforms with  $V_{\text{CC}}$  Varied

## Applications Information

### Negative-Going $V_{CC}$ Transients

In addition to asserting a reset signal during power-up, power-down, and brown-out conditions, the MAX6806/MAX6807/MAX6808 are immune to short-duration, negative-going  $V_{CC}$  transients.

Figure 3 displays typical transient durations vs. reset-comparator overdrive for which the MAX6806/MAX6807/MAX6808 do **not** generate a reset pulse. The graph was generated using a negative-going pulse applied to  $V_{CC}$ , starting 0.5V above the actual reset threshold and ending below it by the magnitude indicated (reset-comparator overdrive). The graph indicates the maximum pulse width a negative-going  $V_{CC}$  transient can have without causing a reset pulse. As the magnitude of the transient increases (goes further below the reset threshold), the maximum allowable pulse width decreases. A 0.1 $\mu$ F capacitor mounted as close as possible to  $V_{CC}$  provides additional transient immunity.

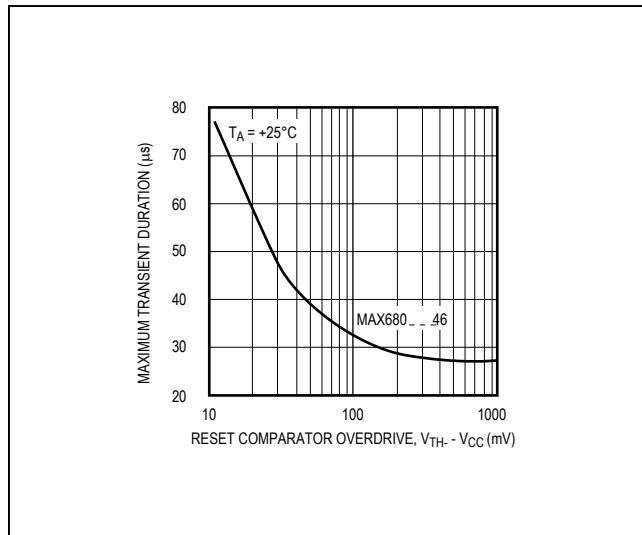

Figure 3. Maximum Transient Duration without Causing a Reset Pulse vs. Reset Comparator Overdrive

### Ensuring a Valid Reset Output Down to $V_{CC} = \text{Ground}$

When  $V_{CC}$  falls below 1V, the MAX6806/MAX6808  $\overline{\text{RESET}}$  output no longer sinks current—it becomes an open circuit. Therefore, high-impedance CMOS logic inputs connected to  $\overline{\text{RESET}}$  can drift to undetermined voltages. This presents no problem in most applications, since most circuitry is inoperative when  $V_{CC}$  is below 1V. In applications where  $\overline{\text{RESET}}$  must be valid down to ground, add a pulldown resistor to  $\overline{\text{RESET}}$  so any stray leakage currents flow to ground, holding  $\overline{\text{RESET}}$  low (Figure 4). Select R1 to be large enough not to load  $\overline{\text{RESET}}$  and small enough to pull  $\overline{\text{RESET}}$  to ground. For most applications, 100k $\Omega$  will not load  $\overline{\text{RESET}}$  and will pull  $\overline{\text{RESET}}$  to ground. Similarly, if RESET (MAX6807) must be valid below 1.2V, add a pullup resistor to RESET.

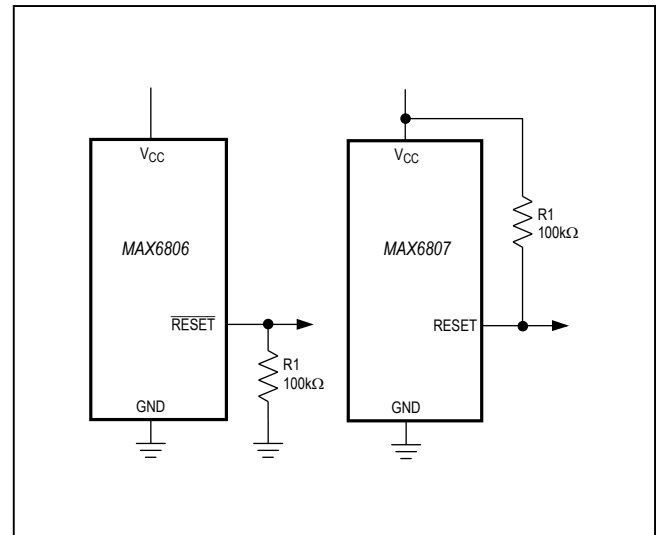

Figure 4.  $\overline{\text{RESET}}$  / RESET Valid to  $V_{CC} = \text{Ground}$  Circuit

**Interfacing to  $\mu$ Ps with Bidirectional Reset Pins**

$\mu$ Ps with bidirectional reset pins (such as the Motorola 68HC11 series) can contend with push-pull  $\overline{\text{RESET}}$  outputs, resulting in indeterminate logic levels. Use the MAX6808 with the open-drain  $\overline{\text{RESET}}$  when interfacing to this type of controller.

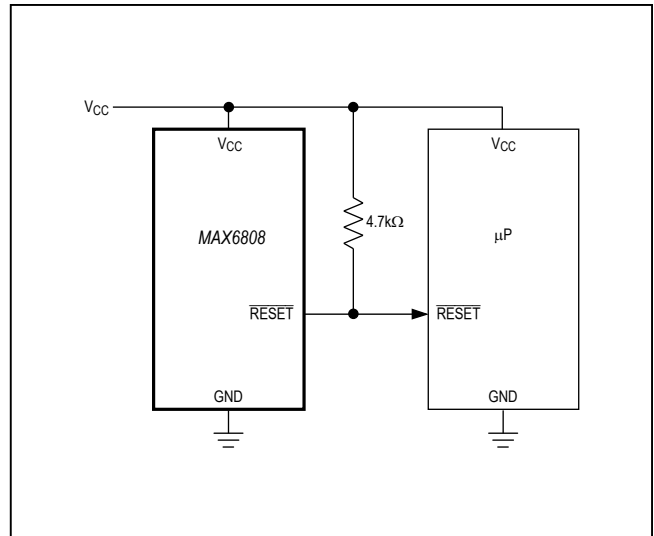

Figure 5. Interfacing to  $\mu$ Ps with Bidirectional Reset I/O

**Selector Guide**

PART	RESET OUTPUT	TOP MARK	NOMINAL $V_{TH}$ - (V)†
MAX6806SA46	Active-Low, Push-Pull	—	4.6
MAX6806SA26		—	2.6
MAX6806SA23		—	2.3
MAX6806UA46		—	4.6
MAX6806UA26		—	2.6
MAX6806UA23		—	2.3
MAX6806UR46-T		FZDP	4.6
MAX6806UR26-T		FZDQ	2.6
MAX6806UR23-T		FZDR	2.3
MAX6806US46-T		KABT	4.6
MAX6806US26-T		KABU	2.6
MAX6806US23-T		KABV	2.3
MAX6806XR46-T		AAA	4.6
MAX6806XR26-T		AAB	2.6
MAX6806XR23-T		AAC	2.3

Selector Guide (continued)

PART	RESET OUTPUT	TOP MARK	NOMINAL V <sub>TH</sub> - (V) †
MAX6807SA46	Active-High, Push-Pull	—	4.6
MAX6807SA26		—	2.6
MAX6807UA46		—	4.6
MAX6807UA26		—	2.6
MAX6807UR46-T		FZDS	4.6
MAX6807UR26-T		FZDT	2.6
MAX6807US46-T		KABW	4.6
MAX6807US26-T		KABX	2.6
MAX6807XR46-T		AAD	4.6
MAX6807XR26-T		AAE	2.6
MAX6808SA46		Active-Low, Open-Drain	—
MAX6808SA32	—		3.2
MAX6808SA26	—		2.6
MAX6808UA46	—		4.6
MAX6808UA32	—		3.2
MAX6808UA26	—		2.6
MAX6808UR46-T	FZDU		4.6
MAX6808UR32-T	FZFL		3.2
MAX6808UR26-T	FZDV		2.6
MAX6808US46-T	KABY		4.6
MAX6808US32-T	KACC		3.2
MAX6808US26-T	KABZ		2.6
MAX6808XR46-T	AAF		4.6
MAX6808XR32-T	ACD		3.2
MAX6808XR26-T	AAG		2.6

Other voltage thresholds may be available. Contact factory for availability.

### Pin Configurations

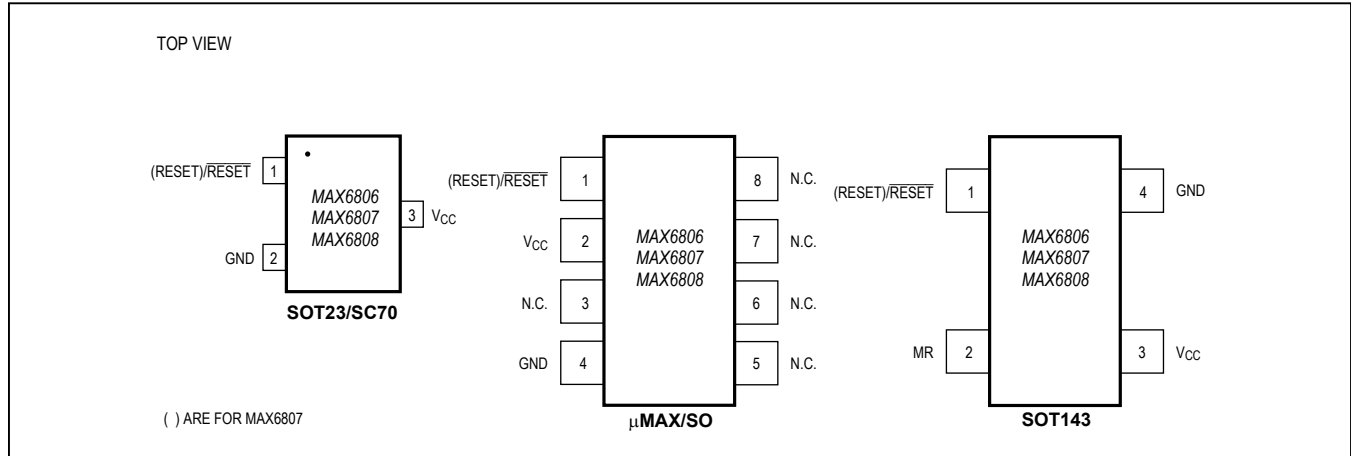

### Chip Information

TRANSISTOR COUNT: 72

### Package Information

For the latest package outline information and land patterns (footprints), go to [www.maximintegrated.com/packages](http://www.maximintegrated.com/packages). Note that a "+", "#", or "-" in the package code indicates RoHS status only. Package drawings may show a different suffix character, but the drawing pertains to the package regardless of RoHS status.

PACKAGE TYPE	PACKAGE CODE	OUTLINE NO.	LAND PATTERN NO.
3 SC70	X3-2	<a href="#">21-0075</a>	<a href="#">90-0208</a>
3 SOT23	U3-1	<a href="#">21-0051</a>	<a href="#">90-0179</a>
4 SOT143	U4-1	<a href="#">21-0052</a>	<a href="#">90-0183</a>
8 SO	—	<a href="#">21-0041</a>	—
8 μMAX	—	<a href="#">21-0036</a>	—

## Revision History

REVISION NUMBER	REVISION DATE	DESCRIPTION	PAGES CHANGED
3	7/14	No IV OPNs; removed Automotive reference from <i>Applications</i> section; updated <i>Package Information</i>	1, 9–13

For pricing, delivery, and ordering information, please contact Maxim Direct at 1-888-629-4642, or visit Maxim Integrated's website at [www.maximintegrated.com](http://www.maximintegrated.com).

*Maxim Integrated cannot assume responsibility for use of any circuitry other than circuitry entirely embodied in a Maxim Integrated product. No circuit patent licenses are implied. Maxim Integrated reserves the right to change the circuitry and specifications without notice at any time. The parametric values (min and max limits) shown in the Electrical Characteristics table are guaranteed. Other parametric values quoted in this data sheet are provided for guidance.*

## Looking for pricing, stock, or lifecycle information?

Click below to explore more details on WIN SOURCE:

- ⊖ [View MAX6806UR46+T on WIN SOURCE](#)
- ⊖ [Maxim Integrated Information](#)

## Optimize Your Supply Chain with WIN SOURCE Solutions

- ✓ Global Sourcing Solution
- ✓ Obsolete Management
- ✓ Cost Control Management
- ✓ Shortage Management
- ✓ Alternative Solution
- ✓ Excess Inventory Management