



**THE DATASHEET OF  
MAX6177AASA+**



## MAX6173–MAX6177

## High-Precision Voltage References with Temperature Sensor

### General Description

The MAX6173–MAX6177 are low-noise, high-precision voltage references. The devices feature a proprietary temperature-coefficient curvature-correction circuit and laser-trimmed thin-film resistors that result in a very low 3ppm/°C temperature coefficient and excellent  $\pm 0.06\%$  initial accuracy. The MAX6173–MAX6177 provide a TEMP output where the output voltage is proportional to the die temperature, making the devices suitable for a wide variety of temperature-sensing applications. The devices also provide a TRIM input, allowing fine trimming of the output voltage with a resistive divider network. Low temperature drift and low noise make the devices ideal for use with high-resolution A/D or D/A converters.

The MAX6173–MAX6177 provide accurate preset +2.5V, +3.3V, +4.096V, +5.0V, and +10V reference voltages and accept input voltages up to +40V. The devices draw 320 $\mu$ A (typ) of supply current and source 30mA or sink 2mA of load current. The MAX6173–MAX6177 use band-gap technology for low-noise performance and excellent accuracy. The MAX6173–MAX6177 do not require an output bypass capacitor for stability, and are stable with capacitive loads up to 100 $\mu$ F. Eliminating the output bypass capacitor saves valuable board area in space-critical applications.

The MAX6173–MAX6177 are available in an 8-pin SO package and operate over the automotive (-40°C to +125°C) temperature range.

### Applications

- ADCs
- DACs
- Digital Voltmeters
- Automotive
- Voltage Regulators
- Threshold Detectors

**Pin Configuration and Ordering Information appears at end of data sheet.**

### Benefits and Features

- Wide ( $V_{OUT} + 2V$ ) to +40V Supply Voltage Range
- Excellent Temperature Stability: 3ppm/°C (max)
- Tight Initial Accuracy: 0.05% (max)
- Low Noise: 3.8 $\mu$ V<sub>P-P</sub> (typ at 2.5V Output)
- Sources up to 30mA Output Current
- Low Supply Current: 450 $\mu$ A (max at +25°C)
- Linear Temperature Transducer Voltage Output
- +2.5V, +3.3V, +4.096V, +5.0V, or +10V Output Voltages
- Wide Operating Temperature Range: -40°C to +125°C
- No External Capacitors Required for Stability
- Short-Circuit Protected
- AEC-Q100 Qualified (Refer to Ordering Info Section for I/V parts)

### Typical Operating Circuit

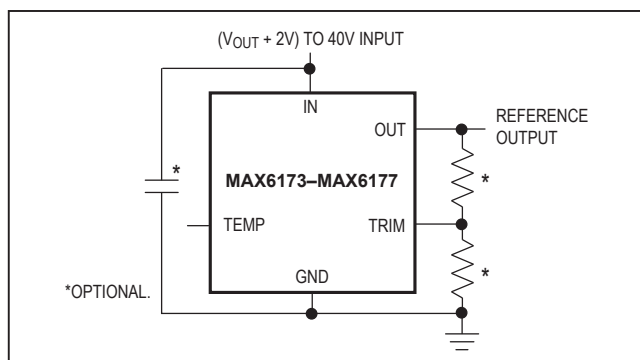

**Absolute Maximum Ratings**

IN to GND.....	-0.3V to +42V	Operating Temperature Range.....	-40°C to +125°C
OUT, TRIM, TEMP to GND .....	-0.3V to (V <sub>IN</sub> + 0.3V)	Junction Temperature.....	+150°C
Output Short-Circuit to GND .....	5s	Storage Temperature Range.....	-65°C to +150°C
Continuous Power Dissipation (T <sub>A</sub> = +70°C) (Note1)		Lead Temperature (soldering, 10s) .....	+300°C
8-Pin SO (derate 7.6mW/°C above +70°C).....	606mW	Soldering Temperature (reflow).....	+260°C

Stresses beyond those listed under "Absolute Maximum Ratings" may cause permanent damage to the device. These are stress ratings only, and functional operation of the device at these or any other conditions beyond those indicated in the operational sections of the specifications is not implied. Exposure to absolute maximum rating conditions for extended periods may affect device reliability.

**Package Thermal Characteristics (Note 1)**

**8 SO**

PACKAGE CODE	S8+4
Outline Number	<a href="#">21-0041</a>
Land Pattern Number	<a href="#">90-0096</a>
<b>Thermal Resistance, Single-Layer Board</b>	
Junction to Ambient - $\theta_{JA}$	170
Junction to Case - $\theta_{JC}$	40
<b>Thermal Resistance, Multi-Layer Board</b>	
Junction to Ambient - $\theta_{JA}$	132°C/W
Junction to Case - $\theta_{JC}$	38°C/W

**8 SO**

PACKAGE CODE	S8+22
Outline Number	<a href="#">21-0041</a>
Land Pattern Number	<a href="#">90-0096</a>
<b>Thermal Resistance, Single-Layer Board</b>	
Junction to Ambient - $\theta_{JA}$	170°C/W
Junction to Case - $\theta_{JC}$	40°C/W
<b>Thermal Resistance, Multi-Layer Board</b>	
Junction to Ambient - $\theta_{JA}$	132°C/W
Junction to Case - $\theta_{JC}$	38°C/W

For the latest package outline information and land patterns (footprints), go to [www.maximintegrated.com/packages](http://www.maximintegrated.com/packages). Note that a "+", "#", or "-" in the package code indicates RoHS status only. Package drawings may show a different suffix character, but the drawing pertains to the package regardless of RoHS status.

Package thermal resistances were obtained using the method described in JEDEC specification JESD51-7, using a four-layer board. For detailed information on package thermal considerations, refer to [www.maximintegrated.com/thermal-tutorial](http://www.maximintegrated.com/thermal-tutorial).

**Electrical Characteristics—MAX6173 (V<sub>OUT</sub> = 2.5V)**(V<sub>IN</sub> = +5V, T<sub>A</sub> = -40°C to +125°C, unless otherwise noted. Typical values are at T<sub>A</sub> = +25°C.) (Note 2)

PARAMETER	SYMBOL	CONDITIONS	MIN	TYP	MAX	UNITS	
<b>OUTPUT</b>							
Output Voltage	V <sub>OUT</sub>	No load, T <sub>A</sub> = +25°C	MAX6173A (0.06%)	2.4985	2.5	2.5015	V
			MAX6173B (0.1%)	2.4975	2.5	2.5025	
Output Adjustment Range	ΔV <sub>TRIM</sub>	R <sub>POT</sub> = 10kΩ	±3	±6		%	
Output-Voltage Temperature Coefficient (Note 3)	TCV <sub>OUT</sub>	T <sub>A</sub> = -40°C to +125°C	MAX6173AASA		1.5	3	ppm/°C
			MAX6173BASA		3	10	
Line Regulation (Note 4)	ΔV <sub>OUT</sub> /ΔV <sub>IN</sub>	4.5V ≤ V <sub>IN</sub> ≤ 40V	T <sub>A</sub> = +25°C		0.6	5	ppm/V
			T <sub>A</sub> = -40°C to +125°C		0.8	10	
Load Regulation (Note 4)	ΔV <sub>OUT</sub> /ΔI <sub>OUT</sub>	Sourcing: 0 ≤ I <sub>OUT</sub> ≤ 10mA	T <sub>A</sub> = +25°C		2	10	ppm/mA
			T <sub>A</sub> = -40°C to +125°C		2	15	
		Sinking: -0.6mA ≤ I <sub>OUT</sub> ≤ 0	T <sub>A</sub> = +25°C		50	500	
			T <sub>A</sub> = -40°C to +125°C		90	900	
Output Short-Circuit Current	I <sub>SC</sub>	OUT shorted to GND		60		mA	
		OUT shorted to IN		3			
Temperature Hysteresis (Note 5)	ΔV <sub>OUT</sub> /cycle			120		ppm	
Long-Term Stability	ΔV <sub>OUT</sub> /time	1000 hours at T <sub>A</sub> = +25°C		50		ppm	
<b>DYNAMIC</b>							
Noise Voltage	e <sub>OUT</sub>	f = 0.1Hz to 10Hz		3.8		μV <sub>P-P</sub>	
		f = 10Hz to 1kHz		6.8		μV <sub>RMS</sub>	
Turn-On Settling Time	t <sub>R</sub>	To V <sub>OUT</sub> = 0.1% of final value, C <sub>OUT</sub> = 50pF		150		μs	
<b>INPUT</b>							
Supply Voltage Range	V <sub>IN</sub>	Guaranteed by line regulation test	4.5		40.0	V	
Quiescent Supply Current	I <sub>IN</sub>	No load	T <sub>A</sub> = +25°C		300	450	μA
			T <sub>A</sub> = -40°C to +125°C			600	
<b>TEMP OUTPUT</b>							
TEMP Output Voltage	V <sub>TEMP</sub>			570		mV	
TEMP Temperature Coefficient	TC <sub>TEMP</sub>			1.9		mV/°C	

**Electrical Characteristics—MAX6177 (V<sub>OUT</sub> = 3.3V)**(V<sub>IN</sub> = +10V, T<sub>A</sub> = -40°C to +125°C, unless otherwise noted. Typical values are at T<sub>A</sub> = +25°C.) (Note 2)

PARAMETER	SYMBOL	CONDITIONS	MIN	TYP	MAX	UNITS		
<b>OUTPUT</b>								
Output Voltage	V <sub>OUT</sub>	No load, T <sub>A</sub> = +25°C	MAX6177A (0.06%)	3.2980	3.3	3.3020	V	
			MAX6177B (0.1%)	3.2967	3.3	3.3033		
Output Adjustment Range	ΔV <sub>TRIM</sub>	R <sub>POT</sub> = 10kΩ	±3	±6		%		
Output-Voltage Temperature Coefficient (Note 3)	TCV <sub>OUT</sub>	T <sub>A</sub> = -40°C to +125°C	MAX6177AASA		1.5	3	ppm/°C	
			MAX6177BASA		3	10		
Line Regulation (Note 4)	ΔV <sub>OUT</sub> /ΔV <sub>IN</sub>	5.3V ≤ V <sub>IN</sub> ≤ 40V	T <sub>A</sub> = +25°C		0.6	5	ppm/V	
			T <sub>A</sub> = -40°C to +125°C		0.8	10		
Load Regulation (Note 4)	ΔV <sub>OUT</sub> /ΔI <sub>OUT</sub>	Sourcing: 0 ≤ I <sub>OUT</sub> ≤ 10mA	T <sub>A</sub> = +25°C		2	10	ppm/mA	
			T <sub>A</sub> = -40°C to +125°C		2	15		
			Sinking: -0.6mA ≤ I <sub>OUT</sub> ≤ 0	T <sub>A</sub> = +25°C		50		500
				T <sub>A</sub> = -40°C to +125°C		90		900
Output Short-Circuit Current	I <sub>SC</sub>	OUT shorted to GND		60		mA		
		OUT shorted to IN		3				
Temperature Hysteresis (Note 5)	ΔV <sub>OUT</sub> /cycle			120		ppm		
Long-Term Stability	ΔV <sub>OUT</sub> /time	1000 hours at T <sub>A</sub> = +25°C		50		ppm		
<b>DYNAMIC</b>								
Noise Voltage	e <sub>OUT</sub>	f = 0.1Hz to 10Hz		5		μV <sub>P-P</sub>		
		f = 10Hz to 1kHz		9.3		μV <sub>RMS</sub>		
Turn-On Settling Time	t <sub>R</sub>	To V <sub>OUT</sub> = 0.1% of final value, C <sub>OUT</sub> = 50pF		180		μs		
<b>INPUT</b>								
Supply Voltage Range	V <sub>IN</sub>	Guaranteed by line regulation test	5.3		40.0	V		
Quiescent Supply Current	I <sub>IN</sub>	No load	T <sub>A</sub> = +25°C		320	500	μA	
			T <sub>A</sub> = -40°C to +125°C			650		
<b>TEMP OUTPUT</b>								
TEMP Output Voltage	V <sub>TEMP</sub>			630		mV		
TEMP Temperature Coefficient	TC <sub>TEMP</sub>			2.1		mV/°C		

**Electrical Characteristics—MAX6174 (V<sub>OUT</sub> = 4.096V)**(V<sub>IN</sub> = +10V, T<sub>A</sub> = -40°C to +125°C, unless otherwise noted. Typical values are at T<sub>A</sub> = +25°C.) (Note 2)

PARAMETER	SYMBOL	CONDITIONS	MIN	TYP	MAX	UNITS	
<b>OUTPUT</b>							
Output Voltage	V <sub>OUT</sub>	No load, T <sub>A</sub> = +25°C	MAX6174A (0.06%)	4.0935	4.096	4.0985	V
			MAX6174B (0.1%)	4.0919	4.096	4.1001	
Output Adjustment Range	ΔV <sub>TRIM</sub>	R <sub>POT</sub> = 10kΩ	±3	±6		%	
Output-Voltage Temperature Coefficient (Note 3)	TCV <sub>OUT</sub>	T <sub>A</sub> = -40°C to +125°C	MAX6174AASA		1.5	3	ppm/°C
			MAX6174BASA		3	10	
Line Regulation (Note 4)	ΔV <sub>OUT</sub> /ΔV <sub>IN</sub>	6.1V ≤ V <sub>IN</sub> ≤ 40V	T <sub>A</sub> = +25°C		0.6	5	ppm/V
			T <sub>A</sub> = -40°C to +125°C		0.8	10	
Load Regulation (Note 4)	ΔV <sub>OUT</sub> /ΔI <sub>OUT</sub>	Sourcing: 0 ≤ I <sub>OUT</sub> ≤ 10mA	T <sub>A</sub> = +25°C		2	10	ppm/mA
			T <sub>A</sub> = -40°C to +125°C		2	15	
		Sinking: -0.6mA ≤ I <sub>OUT</sub> ≤ 0	T <sub>A</sub> = +25°C		50	500	
			T <sub>A</sub> = -40°C to +125°C		90	900	
Output Short-Circuit Current	I <sub>SC</sub>	OUT shorted to GND		60		mA	
		OUT shorted to IN		3			
Temperature Hysteresis (Note 5)	ΔV <sub>OUT</sub> /cycle			120		ppm	
Long-Term Stability	ΔV <sub>OUT</sub> /time	1000 hours at T <sub>A</sub> = +25°C		50		ppm	
<b>DYNAMIC</b>							
Noise Voltage	e <sub>OUT</sub>	f = 0.1Hz to 10Hz		7		μV <sub>P-P</sub>	
		f = 10Hz to 1kHz		11.5		μV <sub>RMS</sub>	
Turn-On Settling Time	t <sub>R</sub>	To V <sub>OUT</sub> = 0.1% of final value, C <sub>OUT</sub> = 50pF		200		μs	
<b>INPUT</b>							
Supply Voltage Range	V <sub>IN</sub>	Guaranteed by line regulation test	6.1		40.0	V	
Quiescent Supply Current	I <sub>IN</sub>	No load	T <sub>A</sub> = +25°C	320	500	μA	
			T <sub>A</sub> = -40°C to +125°C		650		
<b>TEMP OUTPUT</b>							
TEMP Output Voltage	V <sub>TEMP</sub>	T <sub>A</sub> = +25°C	475	630	785	mV	
		T <sub>A</sub> = -40°C to +125°C	300		1130		
TEMP Temperature Coefficient	TC <sub>TEMP</sub>			2.1		mV/°C	

**Electrical Characteristics—MAX6175 ( $V_{OUT} = 5.0V$ )** $(V_{IN} = +15V, T_A = -40^{\circ}C$  to  $+125^{\circ}C$ , unless otherwise noted. Typical values are at  $T_A = +25^{\circ}C$ .) (Note 2)

PARAMETER	SYMBOL	CONDITIONS	MIN	TYP	MAX	UNITS	
<b>OUTPUT</b>							
Output Voltage	$V_{OUT}$	No load, $T_A = +25^{\circ}C$	MAX6175A (0.06%)	4.9970	5.0	5.0030	V
			MAX6175B (0.1%)	4.9950	5.0	5.0050	
Output Adjustment Range	$\Delta V_{TRIM}$	$R_{POT} = 10k\Omega$	$\pm 3$	$\pm 6$		%	
Output-Voltage Temperature Coefficient (Note 3)	$TCV_{OUT}$	$T_A = -40^{\circ}C$ to $+125^{\circ}C$	MAX6175AASA	1.5	3	ppm/ $^{\circ}C$	
			MAX6175BASA	3	10		
Line Regulation (Note 4)	$\frac{\Delta V_{OUT}}{\Delta V_{IN}}$	$7V \leq V_{IN} \leq 40V$	$T_A = +25^{\circ}C$	0.6	5	ppm/V	
			$T_A = -40^{\circ}C$ to $+125^{\circ}C$	0.8	10		
Load Regulation (Note 4)	$\frac{\Delta V_{OUT}}{\Delta I_{OUT}}$	Sourcing: $0 \leq I_{OUT} \leq 10mA$	$T_A = +25^{\circ}C$	2	10	ppm/mA	
			$T_A = -40^{\circ}C$ to $+125^{\circ}C$	2	15		
		Sinking: $-0.6mA \leq I_{OUT} \leq 0$	$T_A = +25^{\circ}C$	50	500		
			$T_A = -40^{\circ}C$ to $+125^{\circ}C$	90	900		
Output Short-Circuit Current	$I_{SC}$	OUT shorted to GND		60		mA	
		OUT shorted to IN		3			
Temperature Hysteresis (Note 5)	$\frac{\Delta V_{OUT}}{\text{cycle}}$			120		ppm	
Long-Term Stability	$\frac{\Delta V_{OUT}}{\text{time}}$	1000 hours at $T_A = +25^{\circ}C$		50		ppm	
<b>DYNAMIC</b>							
Noise Voltage	$e_{OUT}$	$f = 0.1Hz$ to $10Hz$		9		$\mu V_{P-P}$	
		$f = 10Hz$ to $1kHz$		14.5		$\mu V_{RMS}$	
Turn-On Settling Time	$t_R$	To $V_{OUT} = 0.1\%$ of final value, $C_{OUT} = 50pF$		230		$\mu s$	
<b>INPUT</b>							
Supply Voltage Range	$V_{IN}$	Guaranteed by line regulation test	7.0		40.0	V	
Quiescent Supply Current	$I_{IN}$	No load	$T_A = +25^{\circ}C$	320	550	$\mu A$	
			$T_A = -40^{\circ}C$ to $+125^{\circ}C$		700		
<b>TEMP OUTPUT</b>							
TEMP Output Voltage	$V_{TEMP}$	$T_A = +25^{\circ}C$	475	630	785	mV	
		$T_A = -40^{\circ}C$ to $+125^{\circ}C$	300		1130		
TEMP Temperature Coefficient	$TC_{TEMP}$			2.1		mV/ $^{\circ}C$	

**ELECTRICAL CHARACTERISTICS—MAX6176 (V<sub>OUT</sub> = 10V)**(V<sub>IN</sub> = +15V, T<sub>A</sub> = -40°C to +125°C, unless otherwise noted. Typical values are at T<sub>A</sub> = +25°C.) (Note 2)

PARAMETER	SYMBOL	CONDITIONS	MIN	TYP	MAX	UNITS	
<b>OUTPUT</b>							
Output Voltage	V <sub>OUT</sub>	No load, T <sub>A</sub> = +25°C	MAX6176A (0.05%)	9.9950	10.0	10.0050	V
			MAX6176B (0.1%)	9.9900	10.0	10.0100	
Output Adjustment Range	ΔV <sub>TRIM</sub>	R <sub>POT</sub> = 10kΩ	±3	±6		%	
Output-Voltage Temperature Coefficient (Note 3)	TCV <sub>OUT</sub>	T <sub>A</sub> = -40°C to +125°C	MAX6176AASA	1.5	3	ppm/°C	
			MAX6176BASA	3	10		
Line Regulation (Note 4)	ΔV <sub>OUT</sub> /ΔV <sub>IN</sub>	12V ≤ V <sub>IN</sub> ≤ 40V	T <sub>A</sub> = +25°C	0.6	5	ppm/V	
			T <sub>A</sub> = -40°C to +125°C	0.8	10		
Load Regulation (Note 4)	ΔV <sub>OUT</sub> /ΔI <sub>OUT</sub>	Sourcing: 0 ≤ I <sub>OUT</sub> ≤ 10mA	T <sub>A</sub> = +25°C	2	10	ppm/mA	
			T <sub>A</sub> = -40°C to +125°C	2	15		
		Sinking: -0.6mA ≤ I <sub>OUT</sub> ≤ 0	T <sub>A</sub> = +25°C	50	500		
			T <sub>A</sub> = -40°C to +125°C	90	900		
Output Short-Circuit Current	I <sub>SC</sub>	OUT shorted to GND		60		mA	
		OUT shorted to IN		3			
Temperature Hysteresis (Note 5)	ΔV <sub>OUT</sub> /cycle			120		ppm	
Long-Term Stability	ΔV <sub>OUT</sub> /time	1000 hours at T <sub>A</sub> = +25°C		50		ppm	
<b>DYNAMIC</b>							
Noise Voltage	e <sub>OUT</sub>	f = 0.1Hz to 10Hz		18		μV <sub>P-P</sub>	
		f = 10Hz to 1kHz		29		μV <sub>RMS</sub>	
Turn-On Settling Time	t <sub>R</sub>	To V <sub>OUT</sub> = 0.1% of final value, C <sub>OUT</sub> = 50pF		400		μs	
<b>INPUT</b>							
Supply Voltage Range	V <sub>IN</sub>	Guaranteed by line regulation test	12.0		40.0	V	
Quiescent Supply Current	I <sub>IN</sub>	No load	T <sub>A</sub> = +25°C	340	550	μA	
			T <sub>A</sub> = -40°C to +125°C		700		
<b>TEMP OUTPUT</b>							
TEMP Output Voltage	V <sub>TEMP</sub>			630		mV	
TEMP Temperature Coefficient	TC <sub>TEMP</sub>			2.1		mV/°C	

**Note 2:** All devices are 100% production tested at T<sub>A</sub> = +25°C and guaranteed by design over T<sub>A</sub> = T<sub>MIN</sub> to T<sub>MAX</sub>, as specified.**Note 3:** Temperature coefficient is defined as ΔV<sub>OUT</sub> divided by the temperature range.**Note 4:** Line and load regulation specifications do not include the effects of self-heating.**Note 5:** Thermal hysteresis is defined as the change in +25°C output voltage before and after cycling the device from T<sub>MAX</sub> to T<sub>MIN</sub>.

Typical Operating Characteristics

( $V_{IN} = +5V$  for  $V_{OUT} = +2.5V$ ,  $V_{IN} = +15V$  for  $V_{OUT} = 4.096V$  and  $V_{OUT} = +10V$ ,  $I_{OUT} = 0$ ,  $T_A = +25^\circ C$ , unless otherwise noted.)

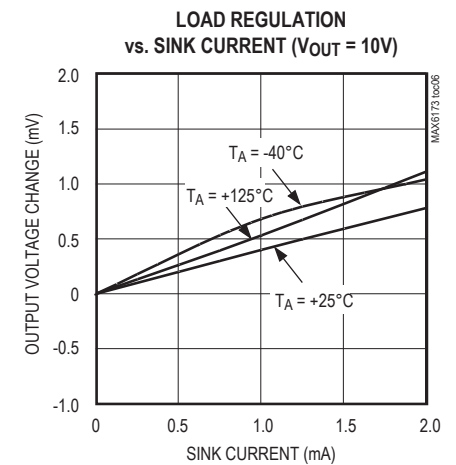
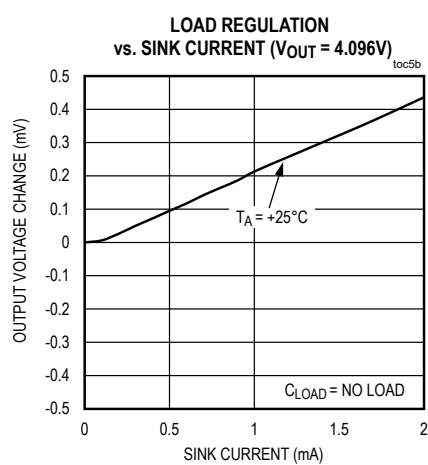
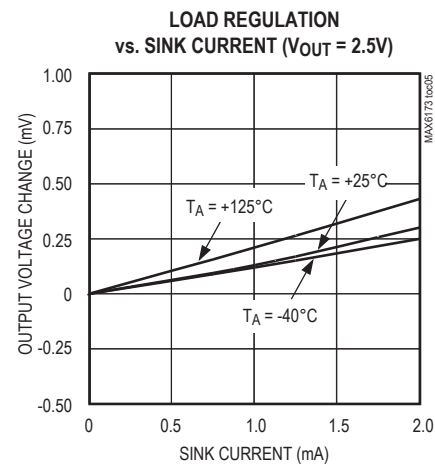
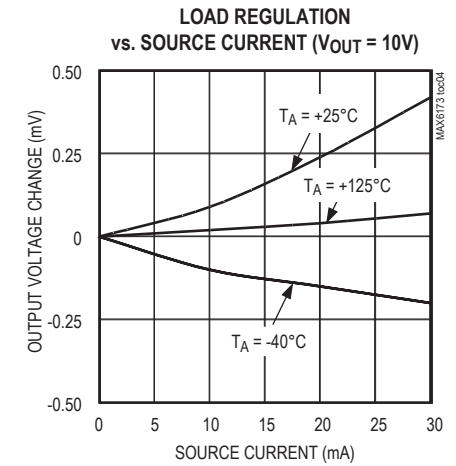
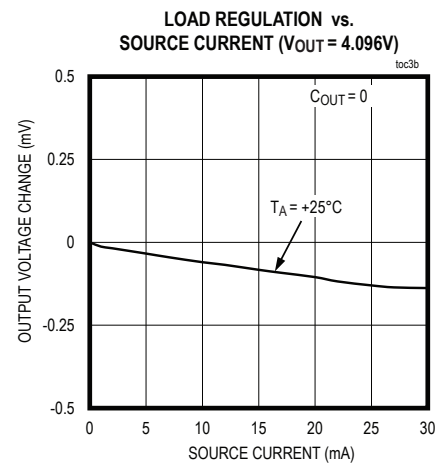
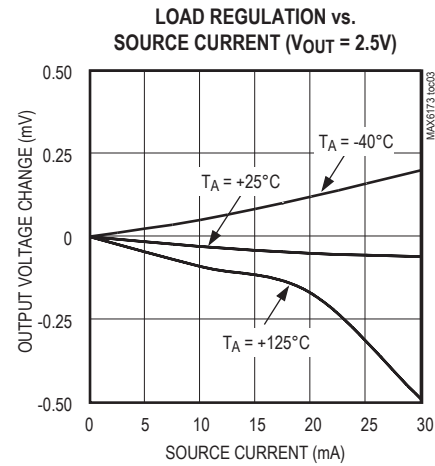
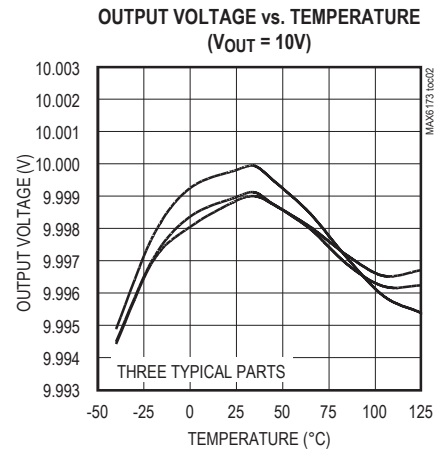
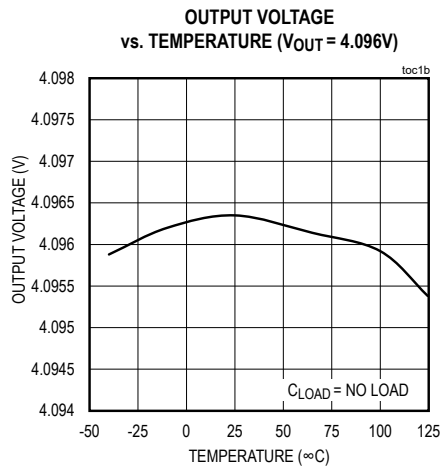
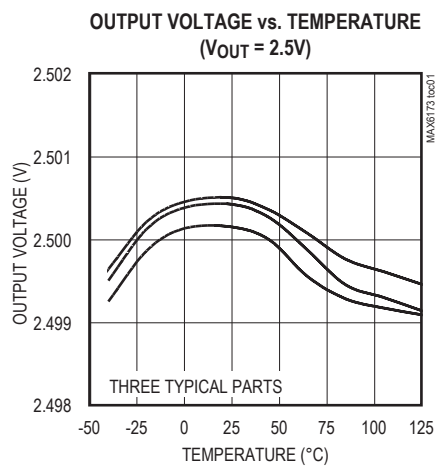

Typical Operating Characteristics (continued)

( $V_{IN} = +5V$  for  $V_{OUT} = +2.5V$ ,  $V_{IN} = +15V$  for  $V_{OUT} = 4.096V$  and  $V_{OUT} = +10V$ ,  $I_{OUT} = 0$ ,  $T_A = +25^\circ C$ , unless otherwise noted.)

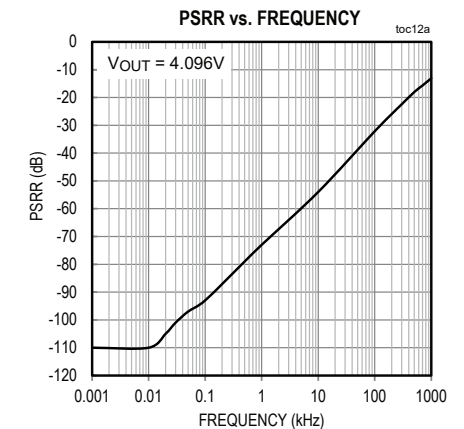
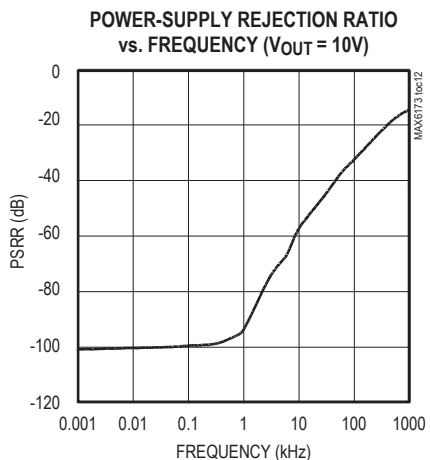
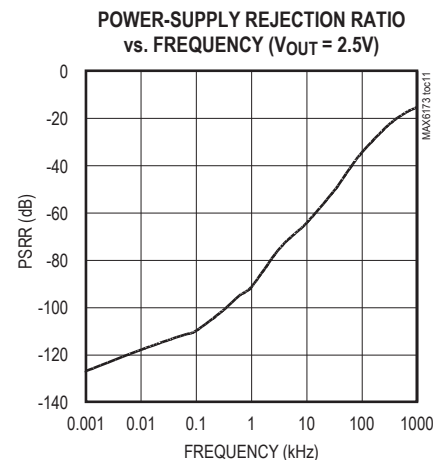
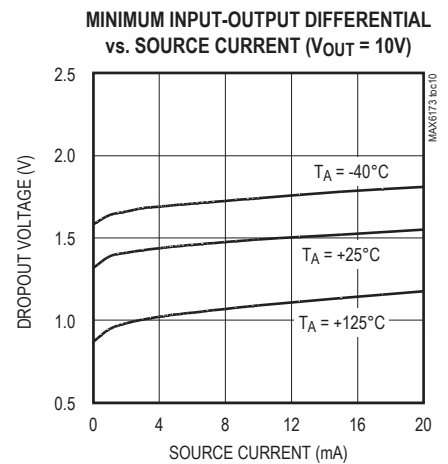
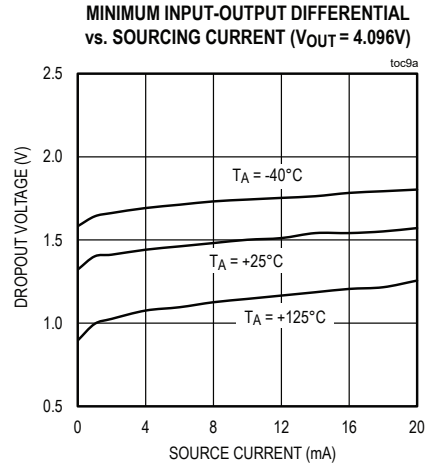
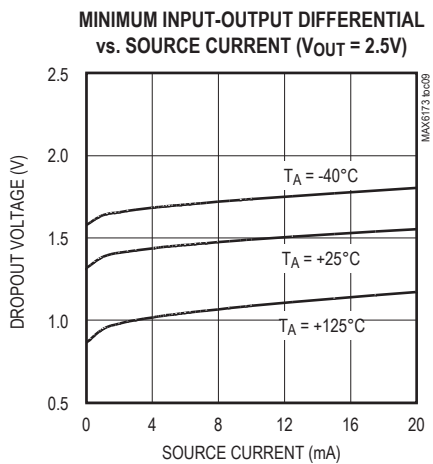
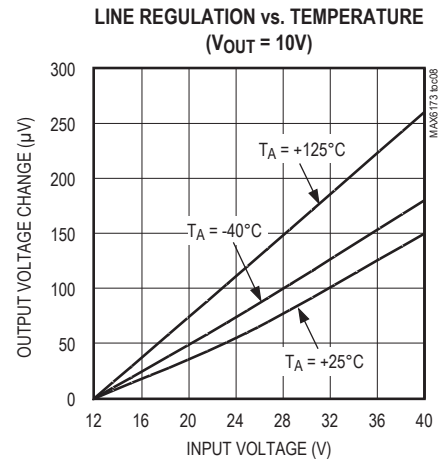
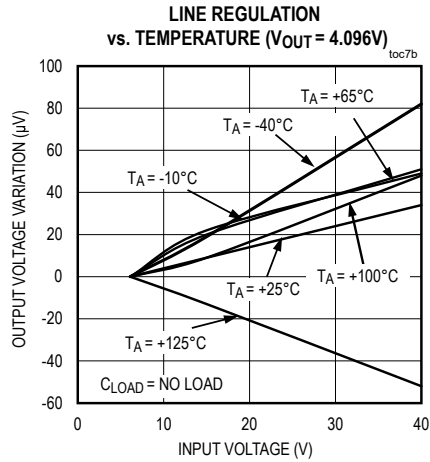
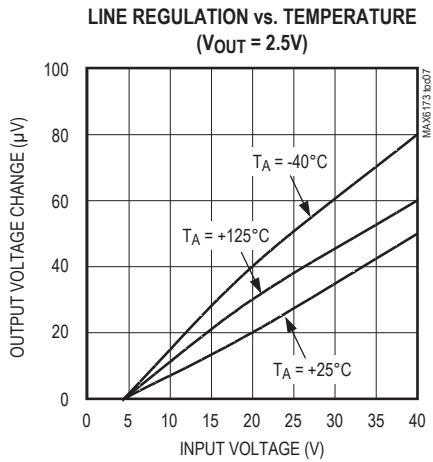

Typical Operating Characteristics (continued)

( $V_{IN} = +5V$  for  $V_{OUT} = +2.5V$ ,  $V_{IN} = +15V$  for  $V_{OUT} = 4.096V$  and  $V_{OUT} = +10V$ ,  $I_{OUT} = 0$ ,  $T_A = +25^\circ C$ , unless otherwise noted.)

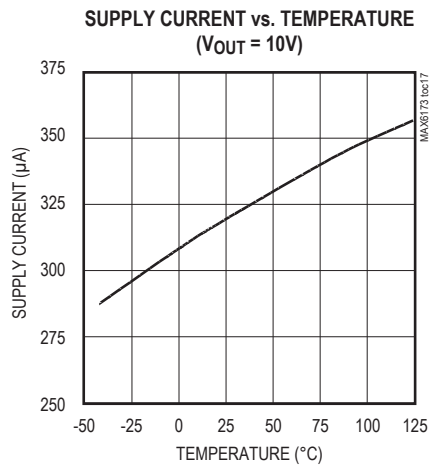
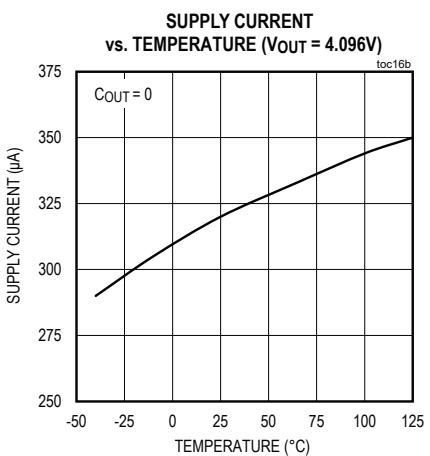
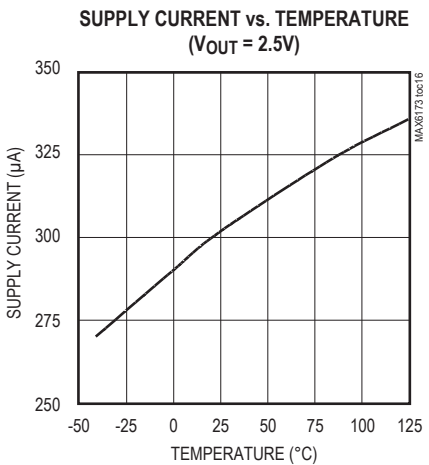
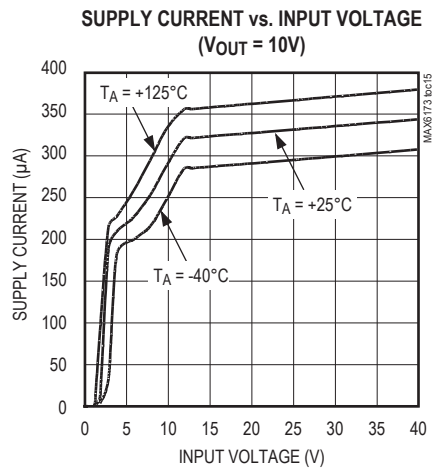
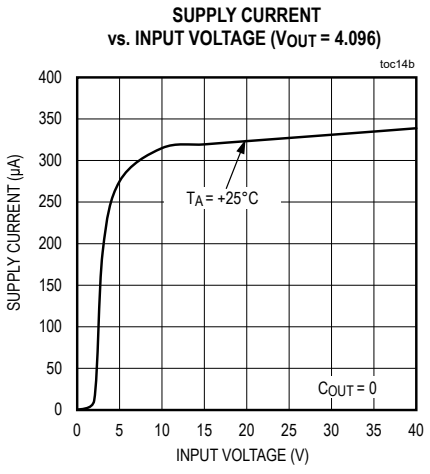
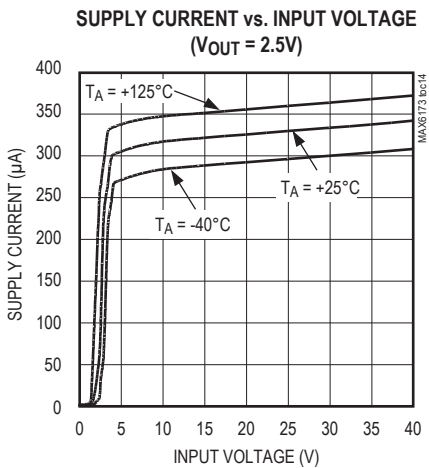
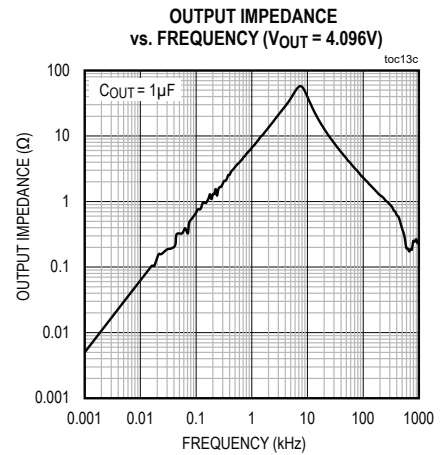
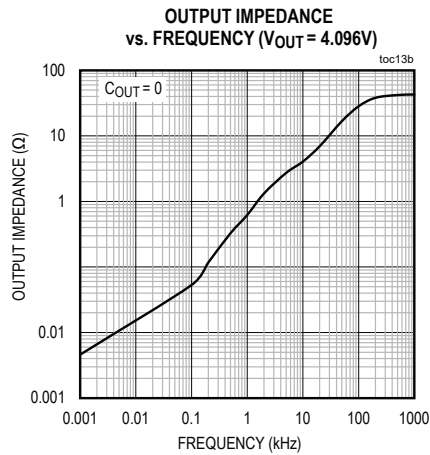
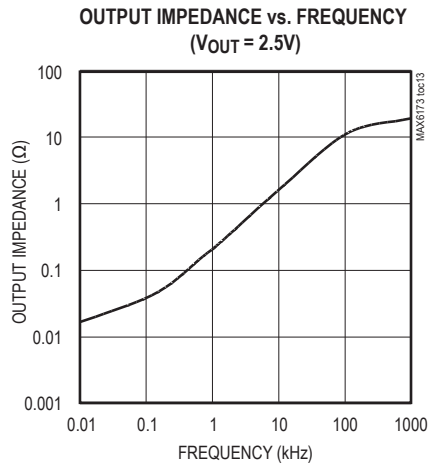

Typical Operating Characteristics (continued)

( $V_{IN} = +5V$  for  $V_{OUT} = +2.5V$ ,  $V_{IN} = +15V$  for  $V_{OUT} = 4.096V$  and  $V_{OUT} = +10V$ ,  $I_{OUT} = 0$ ,  $T_A = +25^\circ C$ , unless otherwise noted.)

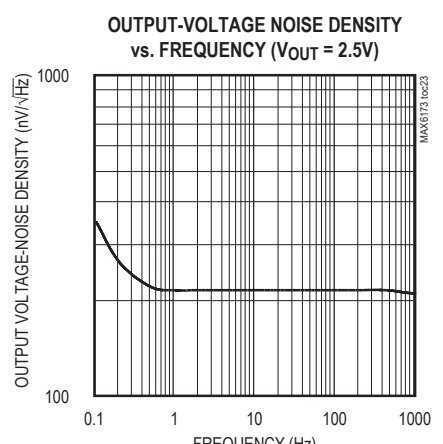
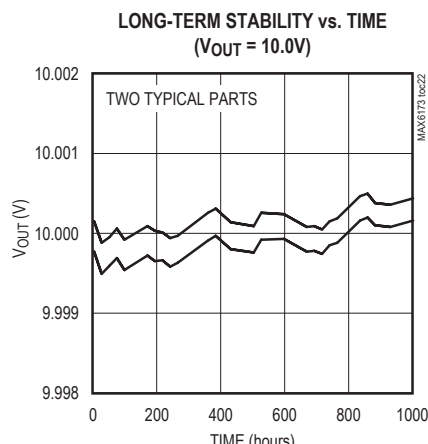
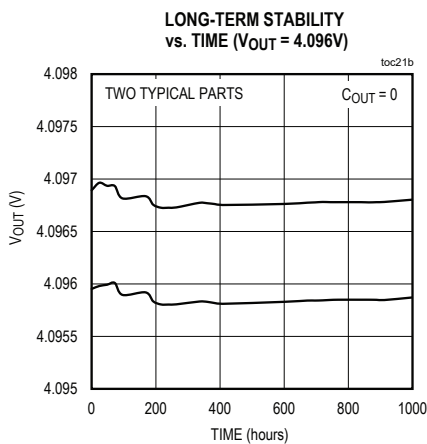
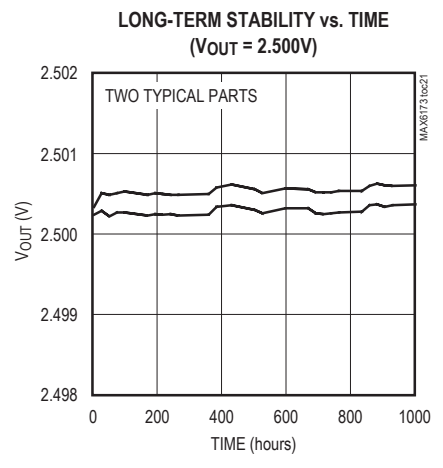
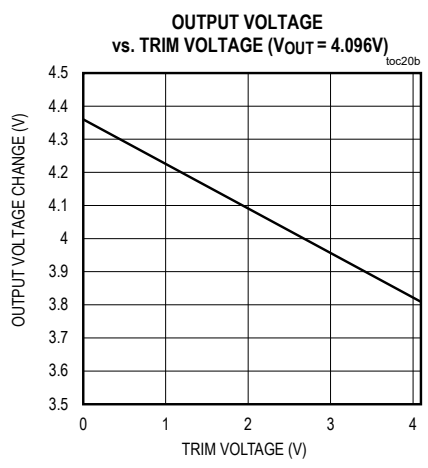
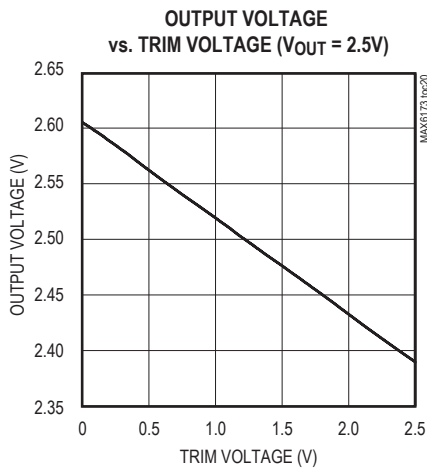
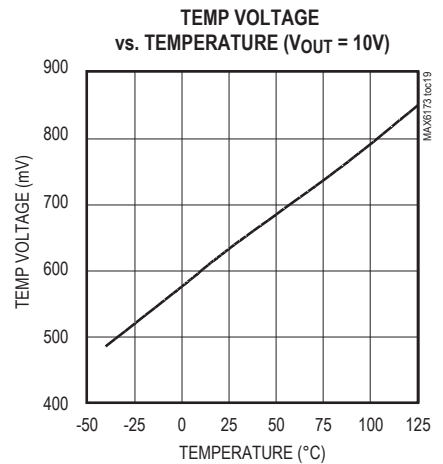
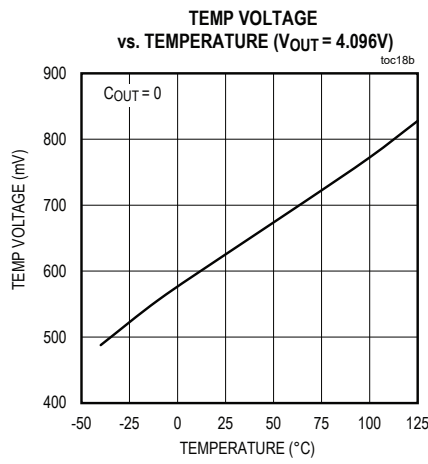
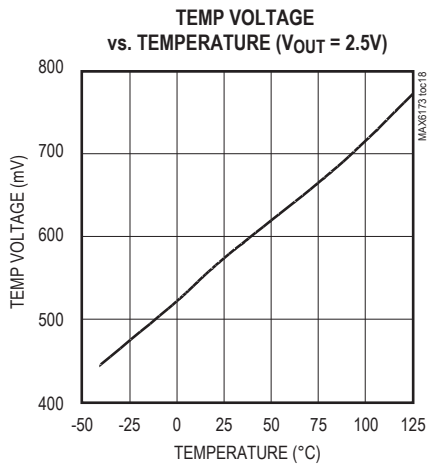

Typical Operating Characteristics (continued)

( $V_{IN} = +5V$  for  $V_{OUT} = +2.5V$ ,  $V_{IN} = +15V$  for  $V_{OUT} = 4.096V$  and  $V_{OUT} = +10V$ ,  $I_{OUT} = 0$ ,  $T_A = +25^{\circ}C$ , unless otherwise noted.)

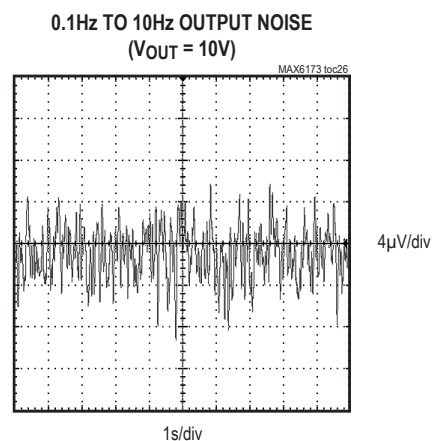
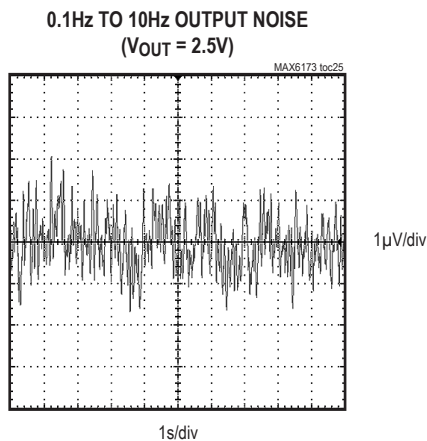
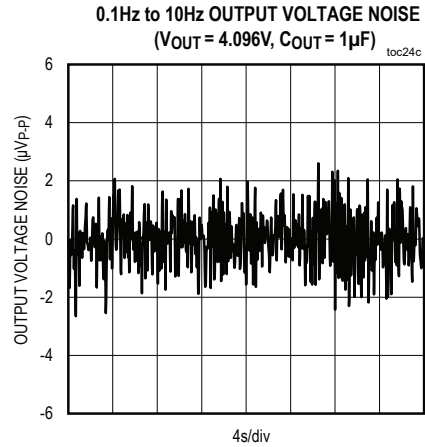
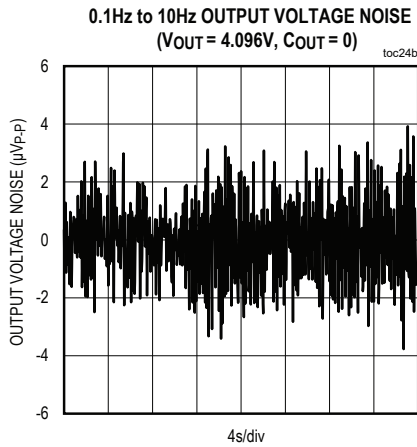
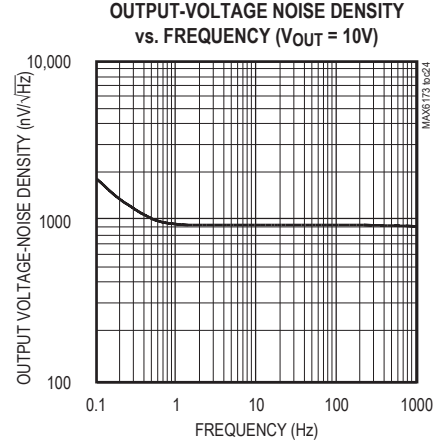
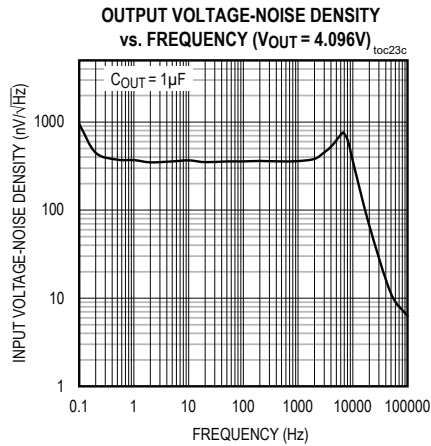
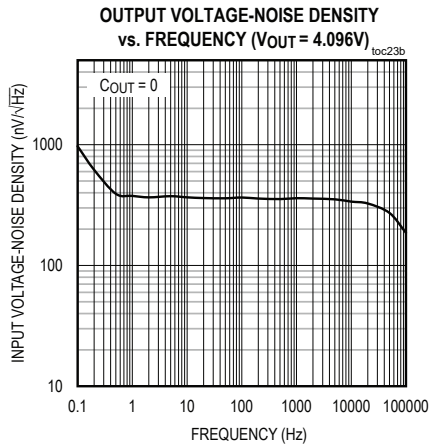

Typical Operating Characteristics (continued)

( $V_{IN} = +5V$  for  $V_{OUT} = +2.5V$ ,  $V_{IN} = +15V$  for  $V_{OUT} = 4.096V$  and  $V_{OUT} = +10V$ ,  $I_{OUT} = 0$ ,  $T_A = +25^\circ C$ , unless otherwise noted.)

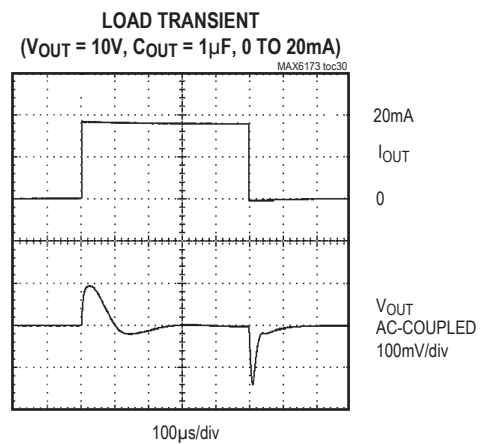
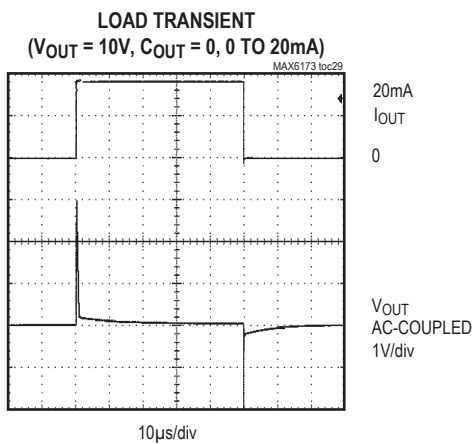
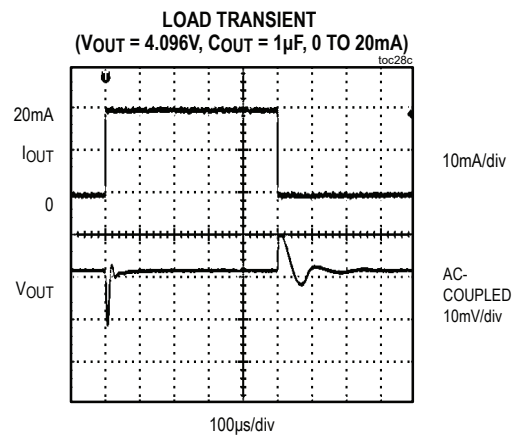
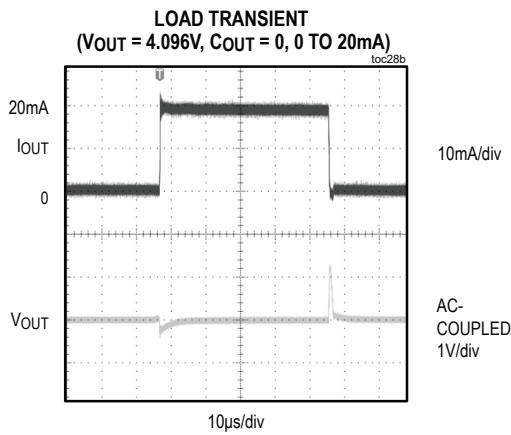
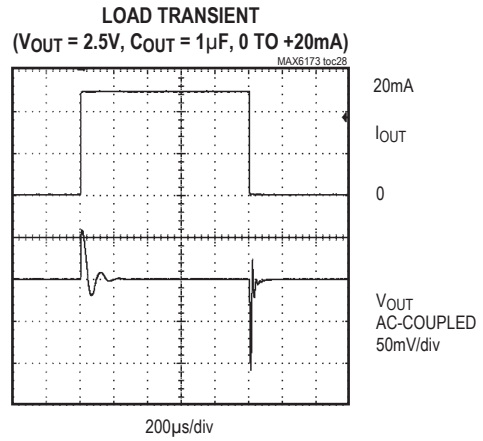
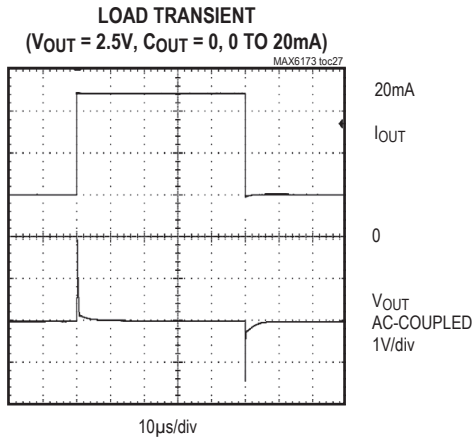

Typical Operating Characteristics (continued)

( $V_{IN} = +5V$  for  $V_{OUT} = +2.5V$ ,  $V_{IN} = +15V$  for  $V_{OUT} = 4.096V$  and  $V_{OUT} = +10V$ ,  $I_{OUT} = 0$ ,  $T_A = +25^\circ C$ , unless otherwise noted.)

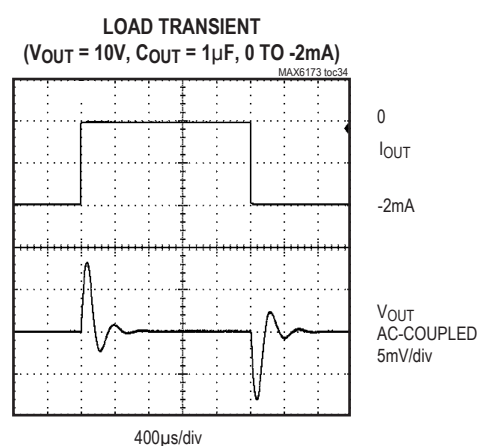
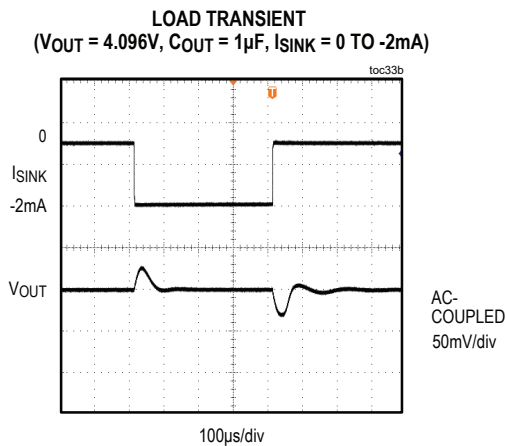
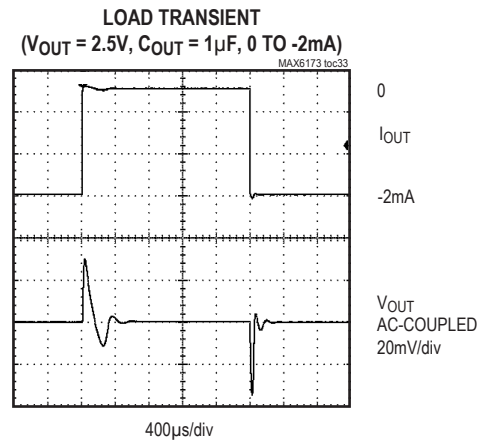
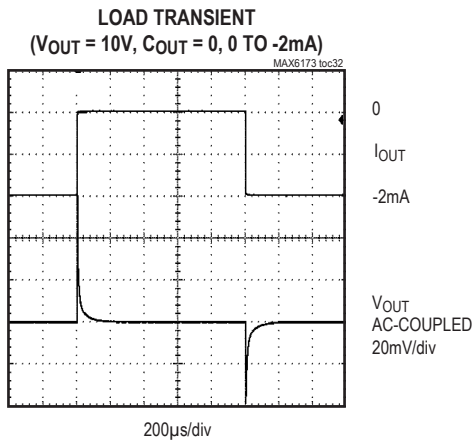
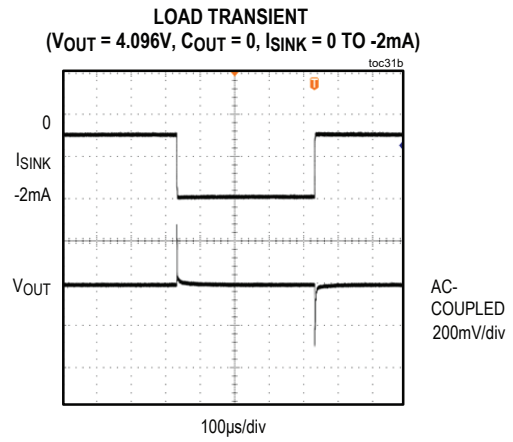
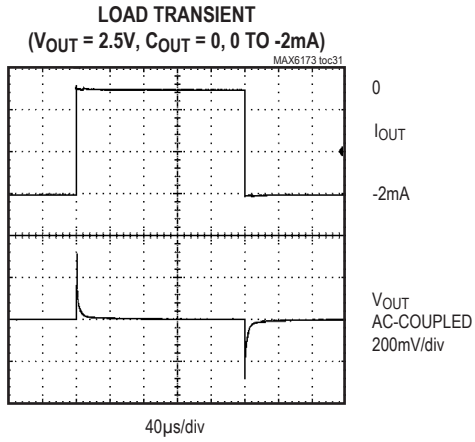

Typical Operating Characteristics (continued)

( $V_{IN} = +5V$  for  $V_{OUT} = +2.5V$ ,  $V_{IN} = +15V$  for  $V_{OUT} = 4.096V$  and  $V_{OUT} = +10V$ ,  $I_{OUT} = 0$ ,  $T_A = +25^\circ C$ , unless otherwise noted.)

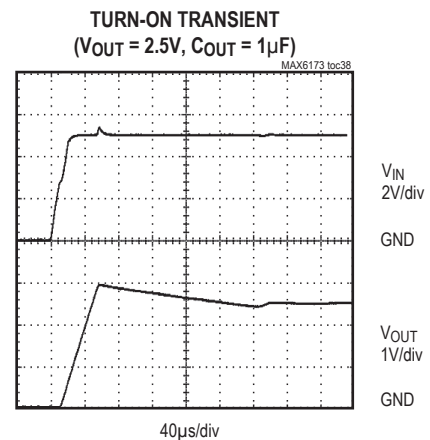
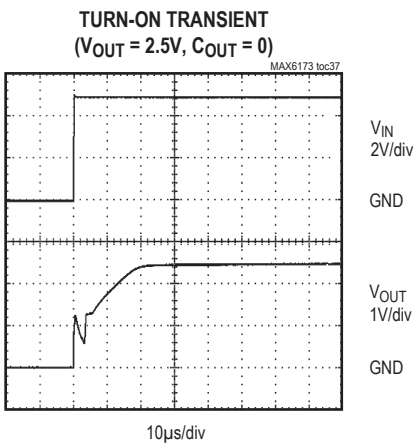
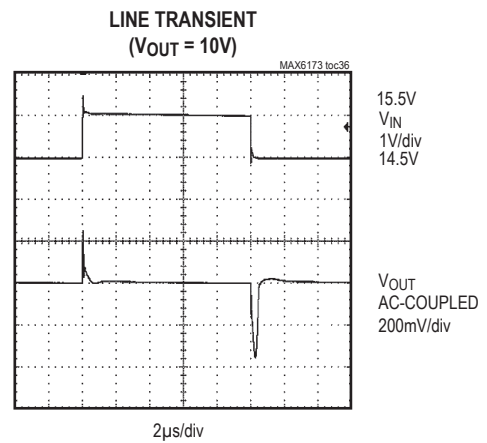
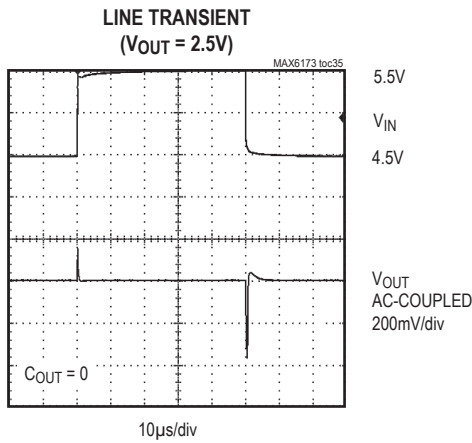
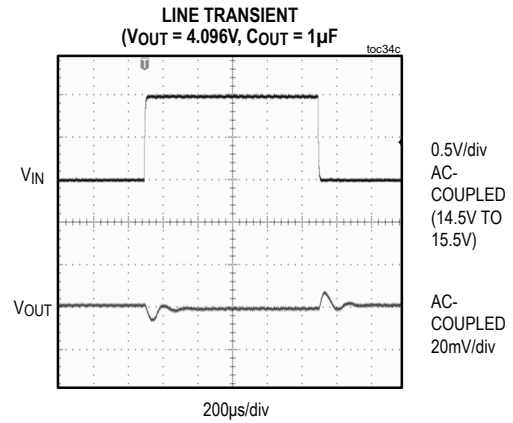
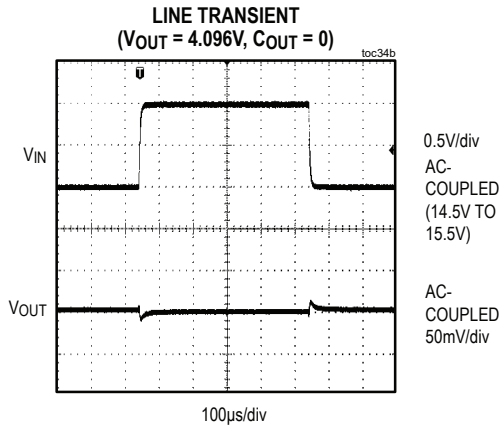

Typical Operating Characteristics (continued)

( $V_{IN} = +5V$  for  $V_{OUT} = +2.5V$ ,  $V_{IN} = +15V$  for  $V_{OUT} = 4.096V$  and  $V_{OUT} = +10V$ ,  $I_{OUT} = 0$ ,  $T_A = +25^{\circ}C$ , unless otherwise noted.)

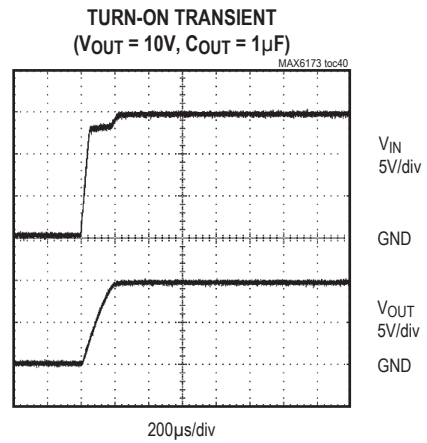
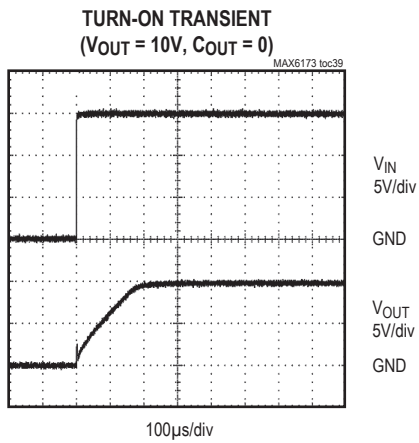
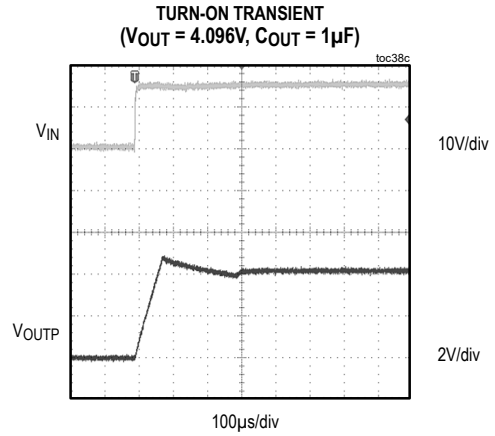
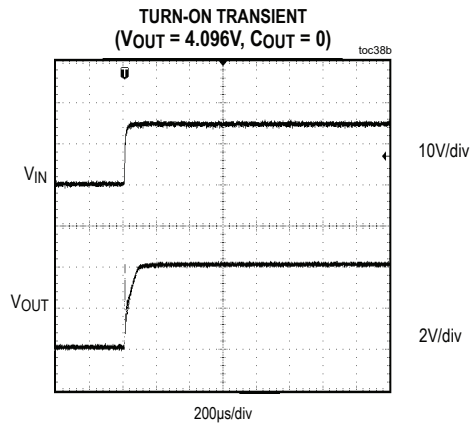

## Pin Description

PIN	NAME	FUNCTION
1, 8	I.C.	Internally Connected. Do not connect externally.
2	IN	Positive Power-Supply Input
3	TEMP	Temperature Proportional Output Voltage. TEMP generates an output voltage proportional to the die temperature.
4	GND	Ground
5	TRIM	Output Voltage Trim. Connect TRIM to the center of a voltage-divider between OUT and GND for trimming. Leave unconnected to use the preset output voltage.
6	OUT	Output Voltage
7	N.C.	No Connection. Not internally connected.

## Detailed Description

The MAX6173–MAX6177 precision voltage references provide accurate preset +2.5V, +3.3V, +4.096V, +5.0V, and +10V reference voltages from up to +40V input voltages. These devices feature a proprietary temperature-coefficient curvature-correction circuit and laser-trimmed thin-film resistors that result in a very low 3ppm/°C temperature coefficient and excellent 0.05% initial accuracy. The MAX6173–MAX6177 draw 340µA of supply current and source 30mA or sink 2mA of load current.

### Trimming the Output Voltage

Trim the factory-preset output voltage on the MAX6173–MAX6177 by placing a resistive divider network between OUT, TRIM, and GND.

Use the following formula to calculate the change in output voltage from its preset value:

$$\Delta V_{OUT} = 2 \times (V_{TRIM} - V_{TRIM(open)}) \times k$$

where:

$$V_{TRIM} = 0V \text{ to } V_{OUT}$$

$$V_{TRIM(open)} = V_{OUT}(\text{nominal})/2 \text{ (typ)}$$

$$k = \pm 6\% \text{ (typ)}$$

For example, use a 50kΩ potentiometer (such as the MAX5436) between OUT, TRIM, and GND with the potentiometer wiper connected to TRIM (see Figure 2). As the TRIM voltage changes from  $V_{OUT}$  to GND, the output voltage changes accordingly. Set R2 to 1MΩ or less. Currents through resistors R1 and R2 add to the quiescent supply current.

### Temp Output

The MAX6173–MAX6177 provide a temperature output proportional to die temperature. TEMP can be calculated from the following formula:

$$TEMP(V) = T_J(°K) \times n$$

where  $T_J$  = the die temperature,

$n$  = the temperature multiplier,

$$n = \frac{V_{TEMP}(\text{at } T_J = T_0)}{T_0} \cong 1.9\text{mV}/°K$$

$T_A$  = the ambient temperature.

Self-heating affects the die temperature and conversely, the TEMP output. The TEMP equation assumes the output is not loaded. If device power dissipation is negligible, then  $T_J \approx T_A$ .

**Applications Information**

**Bypassing/Output Capacitance**

For the best line-transient performance, decouple the input with a 0.1µF ceramic capacitor as shown in the *Typical Operating Circuit*. Place the capacitor as close to IN as possible. When transient performance is less important, no capacitor is necessary.

The MAX6173–MAX6177 do not require an output capacitor for stability and are stable with capacitive loads up to 100µF. In applications where the load or the supply can experience step changes, a larger output capacitor reduces the amount of overshoot (undershoot) and improves the circuit’s transient response. Place output capacitors as close to the devices as possible for best performance.

**Supply Current**

The MAX6173–MAX6177 consume 320µA (typ) of quiescent supply current. This improved efficiency reduces power dissipation and extends battery life.

**Thermal Hysteresis**

Thermal hysteresis is the change in the output voltage at  $T_A = +25^\circ\text{C}$  before and after the device is cycled over its entire operating temperature range. Hysteresis is caused by differential package stress appearing across the band-gap core transistors. The typical thermal hysteresis value is 120ppm.

**Turn-On Time**

The MAX6173–MAX6177 typically turn on and settle to within 0.1% of the preset output voltage in 150µs (2.5V output). The turn-on time can increase up to 150µs with the device operating with a 1µF load.

**Short-Circuited Outputs**

The MAX6173–MAX6177 feature a short-circuit-protected output. Internal circuitry limits the output current to 60mA when short circuiting the output to ground. The output current is limited to 3mA when short circuiting the output to the input.

**Temperature Coefficient vs. Operating Temperature Range for a 1 LSB Maximum Error**

In a data converter application, the reference voltage of the converter must stay within a certain limit to keep the error in the data converter smaller than the resolution limit through the operating temperature range. Figure 1 shows the maximum allowable reference-voltage temperature coefficient to keep the conversion error to less than 1 LSB, as a function of the operating temperature range ( $T_{MAX} - T_{MIN}$ ) with the converter resolution as a parameter. The graph assumes the reference-voltage temperature coefficient as the only parameter affecting accuracy.

In reality, the absolute static accuracy of a data converter is dependent on the combination of many parameters such as integral nonlinearity, differential nonlinearity, offset error, gain error, as well as voltage-reference changes.

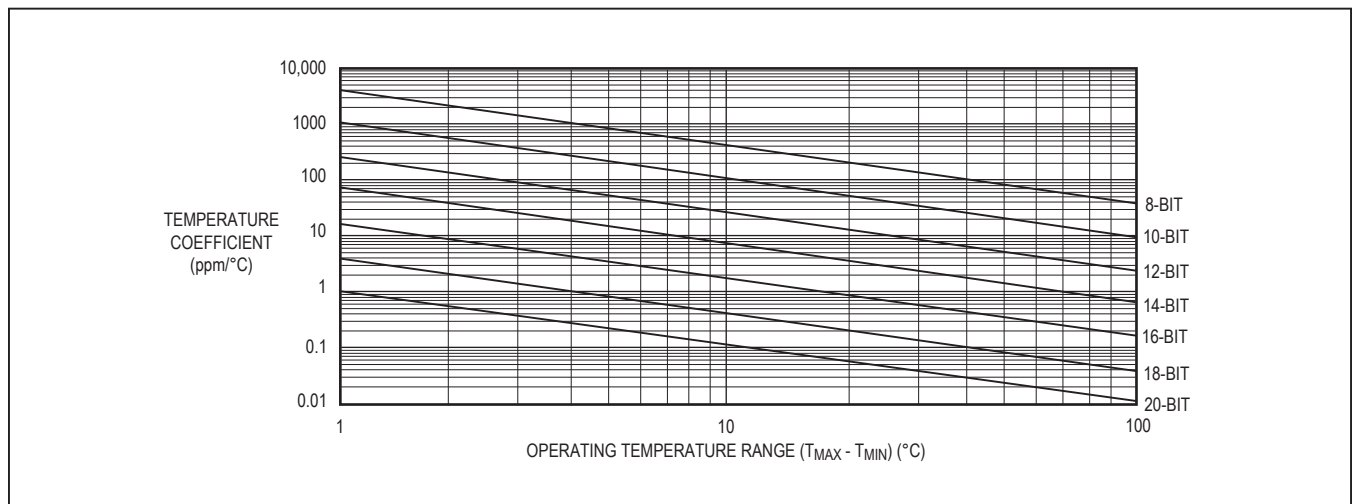

Figure 1. Temperature Coefficient vs. Operating Temperature Range for a 1 LSB Maximum Error

# MAX6173–MAX6177

# High-Precision Voltage References with Temperature Sensor

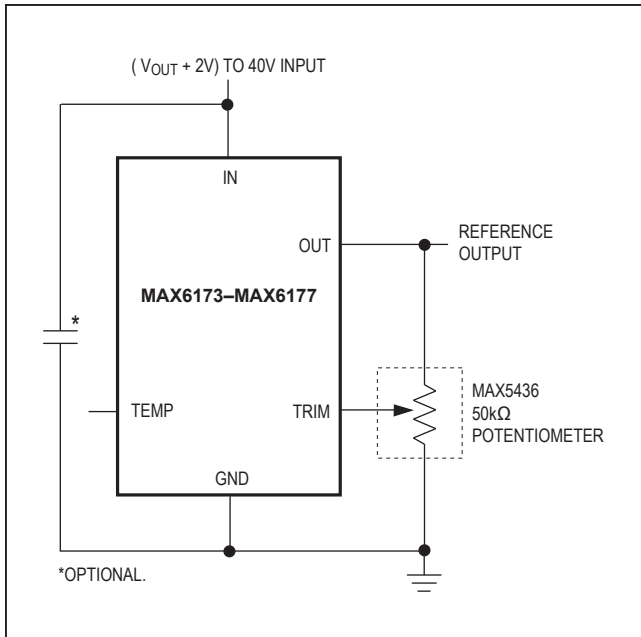
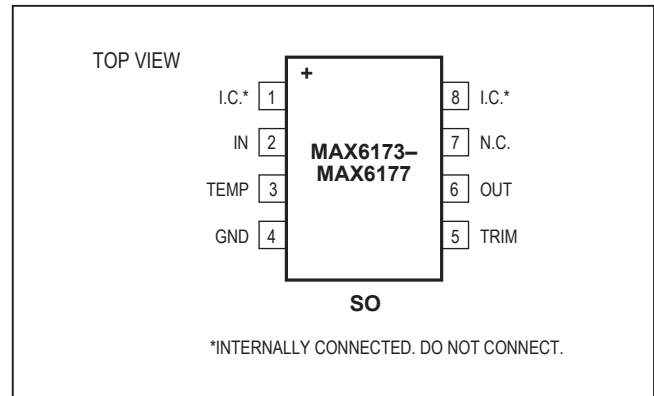

Figure 2. Applications Circuit Using the MAX5436 Potentiometer

## Pin Configuration



## Chip Information

PROCESS: BiCMOS

## Package Information

For the latest package outline information and land patterns (footprints), go to [www.maximintegrated.com/packages](http://www.maximintegrated.com/packages). Note that a “+”, “#”, or “.” in the package code indicates RoHS status only. Package drawings may show a different suffix character, but the drawing pertains to the package regardless of RoHS status.

PACKAGE TYPE	PACKAGE CODE	OUTLINE NO.	LAND PATTERN NO.
8 SO	S8+4	<a href="#">21-0041</a>	<a href="#">90-0096</a>
8 SO	S8+22	<a href="#">21-0041</a>	<a href="#">90-0096</a>

## Ordering Information/Selector Guide

PART	TEMP RANGE	PIN-PACKAGE	OUTPUT VOLTAGE (V)	TEMPERATURE COEFFICIENT (ppm/°C) -40°C TO +125°C	INITIAL ACCURACY (%)
<b>MAX6173</b> AASA+	-40°C to +125°C	8 SO	2.500	3	0.06
MAX6173BASA+	-40°C to +125°C	8 SO	2.500	10	0.10
MAX6173BASA/V+T	-40°C to +125°C	8 SO	2.500	3	0.06
<b>MAX6174</b> AASA+	-40°C to +125°C	8 SO	4.096	3	0.06
MAX6174BASA+	-40°C to +125°C	8 SO	4.096	10	0.10
MAX6174BASA/V+	-40°C to +125°C	8 SO	4.096	10	0.10
MAX6174BASA/V+T	-40°C to +125°C	8 SO	4.096	10	0.10
<b>MAX6175</b> AASA+	-40°C to +125°C	8 SO	5.000	3	0.06
MAX6175BASA+	-40°C to +125°C	8 SO	5.000	10	0.10
MAX6175BASA/V+	-40°C to +125°C	8 SO	5.000	10	0.10
<b>MAX6176</b> AASA+	-40°C to +125°C	8 SO	10.000	3	0.05
MAX6176BASA+	-40°C to +125°C	8 SO	10.000	10	0.10
<b>MAX6177</b> AASA+	-40°C to +125°C	8 SO	3.300	3	0.06
MAX6177BASA+	-40°C to +125°C	8 SO	3.300	10	0.10

+Denotes a lead(Pb)-free/RoHS-compliant package.

/V denotes an automotive qualified part

## Revision History

REVISION NUMBER	REVISION DATE	DESCRIPTION	PAGES CHANGED
0	6/04	Initial release	—
1	2/11	Added automotive grade part, lead-free information, and soldering temperature	1, 2
2	3/14	Updated package code in <i>Package Information</i>	14
3	6/14	Updated <i>Ordering Information</i> , <i>Electrical Characteristics</i> , and <i>Typical Operating Characteristics</i>	1, 4, 5, 8
4	9/14	Updated <i>Typical Operating Characteristics</i>	7–14
5	9/14	Updated <i>Typical Operating Characteristics</i>	7–15
6	12/17	Added AEC statement to <i>Benefits and Features</i> section	1
7	3/18	Updated <i>Ordering Information</i> table	18
8	3/18	Updated <i>Absolute Maximum Ratings</i> section and <i>Electrical Characteristics</i> table	2–6
9	3/18	Updated <i>Absolute Maximum Ratings</i> section	2
10	10/18	Update <i>Applications</i> , <i>Package Thermal Characteristics</i> , <i>Package Information</i> , and <i>Ordering Information/Selector Guide</i>	1, 2, 18
11	4/19	Updated <i>General Description</i> section	1

For pricing, delivery, and ordering information, please visit Maxim Integrated's online storefront at <https://www.maximintegrated.com/en/storefront/storefront.html>.

Maxim Integrated cannot assume responsibility for use of any circuitry other than circuitry entirely embodied in a Maxim Integrated product. No circuit patent licenses are implied. Maxim Integrated reserves the right to change the circuitry and specifications without notice at any time. The parametric values (min and max limits) shown in the *Electrical Characteristics* table are guaranteed. Other parametric values quoted in this data sheet are provided for guidance.

## Looking for pricing, stock, or lifecycle information?

Click below to explore more details on WIN SOURCE:

 [View MAX6177AASA+ on WIN SOURCE](#)

 [Maxim Integrated](#) Information

## Optimize Your Supply Chain with WIN SOURCE Solutions

-  Global Sourcing Solution
-  Obsolete Management
-  Cost Control Management
-  Shortage Management
-  Alternative Solution
-  Excess Inventory Management