



**THE DATASHEET OF
MAX6143AASA50+T**





High-Precision Voltage Reference with Temperature Sensor

MAX6143

General Description

The MAX6143 is a low-noise, high-precision voltage reference. The device features a proprietary temperature-coefficient curvature-correction circuit and laser-trimmed thin-film resistors that result in a very low 3ppm/°C temperature coefficient and excellent $\pm 0.06\%$ initial accuracy. The MAX6143 provides a TEMP output where the output voltage is proportional to die temperature, making the device suitable for a wide variety of temperature-sensing applications. The device also provides a TRIM input, allowing fine trimming of the output voltage with a resistive-divider network. Low temperature drift and low noise make the MAX6143 ideal for use with high-resolution A/D or D/A converters.

The MAX6143 provides accurate preset +2.5V, +3.3V, +4.096V, +5.0V, and +10V reference voltages and accepts input voltages up to +40V. The device draws 340 μ A of supply current and sources 30mA or sinks 2mA of load current. The active-low shutdown feature (SHDN) reduces supply current to 0.01 μ A. The MAX6143 uses bandgap technology for low-noise performance and excellent accuracy. The MAX6143 does not require an output bypass capacitor for stability, and is stable with capacitive loads up to 100 μ F. Eliminating the output bypass capacitor saves valuable board area in space-critical applications.

The MAX6143 is available in an 8-pin SO package and operates over the automotive (-40°C to +125°C) temperature range.

Applications

A/D Converters Voltage Regulators
D/A Converters Threshold Detectors
Digital Voltmeters

Features

- ◆ Wide ($V_{OUT} + 2V$) to +40V Supply Voltage Range
- ◆ Excellent Temperature Stability: 3ppm/°C (max)
- ◆ Tight Initial Accuracy: 0.05% (max)
- ◆ Low Noise: 3.8 μ Vp-p (typ at 2.5V Output)
- ◆ Sources up to 30mA Output Current
- ◆ Low Supply Current: 450 μ A (max at +25°C)
- ◆ Low 0.01 μ A Shutdown Current
- ◆ Linear Temperature Transducer Voltage Output
- ◆ +2.5V, +3.3V, +4.096V, +5.0V, or +10V Output Voltages
- ◆ Wide Operating Temperature Range: -40°C to +125°C
- ◆ No External Capacitors Required for Stability

Typical Operating Circuit

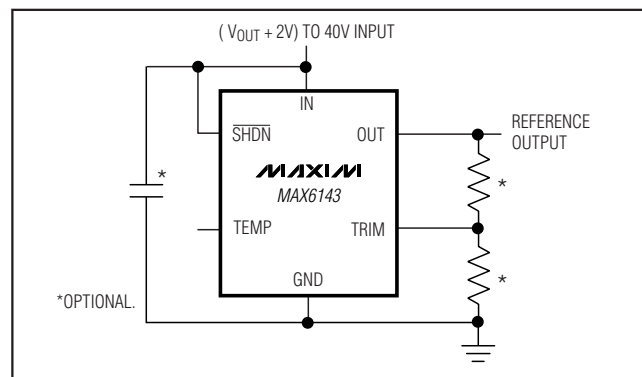

Pin Configuration appears at end of data sheet.

Ordering Information/Selector Guide

| PART | TEMP RANGE | PIN-PACKAGE | OUTPUT VOLTAGE (V) | TEMPERATURE COEFFICIENT (ppm/°C) 40°C TO +125°C | INITIAL ACCURACY (%) |
|---------------|-----------------|-------------|--------------------|---|----------------------|
| MAX6143AASA25 | -40°C to +125°C | 8 SO | 2.500 | 3 | 0.06 |
| MAX6143BASA25 | -40°C to +125°C | 8 SO | 2.500 | 10 | 0.10 |
| MAX6143AASA33 | -40°C to +125°C | 8 SO | 3.300 | 3 | 0.06 |
| MAX6143BASA33 | -40°C to +125°C | 8 SO | 3.300 | 10 | 0.10 |
| MAX6143AASA41 | -40°C to +125°C | 8 SO | 4.096 | 3 | 0.06 |
| MAX6143BASA41 | -40°C to +125°C | 8 SO | 4.096 | 10 | 0.10 |
| MAX6143AASA50 | -40°C to +125°C | 8 SO | 5.000 | 3 | 0.06 |
| MAX6143BASA50 | -40°C to +125°C | 8 SO | 5.000 | 10 | 0.10 |
| MAX6143AASA10 | -40°C to +125°C | 8 SO | 10.000 | 3 | 0.05 |
| MAX6143BASA10 | -40°C to +125°C | 8 SO | 10.000 | 10 | 0.10 |



High-Precision Voltage Reference with Temperature Sensor

ABSOLUTE MAXIMUM RATINGS

| | | | |
|---|-----------------------------------|---|-----------------|
| IN to GND | -0.3V to +42V | Operating Temperature Range | -40°C to +125°C |
| OUT, SHDN, TRIM, TEMP to GND | -0.3V to (V _{IN} + 0.3V) | Junction Temperature | +150°C |
| Output Short Circuit to GND | 5s | Storage Temperature Range | -65°C to +150°C |
| Continuous Power Dissipation (T _A = +70°C) | | Lead Temperature (soldering, 10s) | +300°C |
| 8-Pin SO (derate 5.9mW/°C above +70°C) | 471mW | | |

Stresses beyond those listed under "Absolute Maximum Ratings" may cause permanent damage to the device. These are stress ratings only, and functional operation of the device at these or any other conditions beyond those indicated in the operational sections of the specifications is not implied. Exposure to absolute maximum rating conditions for extended periods may affect device reliability.

ELECTRICAL CHARACTERISTICS—MAX6143_25 (V_{OUT} = 2.5V)

(V_{IN} = V_{SHDN} = +5V, T_A = -40°C to +125°C, unless otherwise noted. Typical values are at T_A = +25°C.) (Note 1)

| PARAMETER | SYMBOL | CONDITIONS | MIN | TYP | MAX | UNITS | |
|---|---------------------------------------|--|---|----------------------------------|------|-------------------|-----|
| OUTPUT | | | | | | | |
| Output Voltage | V _{OUT} | No load, T _A = +25°C | MAX6143A_25 (0.06%) | 2.4985 | 2.5 | 2.5015 | V |
| | | | MAX6143B_25 (0.1%) | 2.4975 | 2.5 | 2.5025 | |
| Output Adjustment Range | ΔV _{TRIM} | R _{POT} = 10kΩ | ±3 | ±6 | | % | |
| Output-Voltage Temperature Coefficient (Note 2) | TCV _{OUT} | T _A = -40°C to +125°C | MAX6143AASA | 1.5 | 3 | ppm/°C | |
| | | | MAX6143BASA | 3 | 10 | | |
| Line Regulation (Note 3) | ΔV _{OUT} / ΔV _{IN} | 4.5V ≤ V _{IN} ≤ 40V | T _A = +25°C | 0.6 | 5 | ppm/V | |
| | | | T _A = -40°C to +125°C | 0.8 | 10 | | |
| Load Regulation (Note 3) | ΔV _{OUT} / ΔI _{OUT} | Sourcing: 0 ≤ I _{OUT} ≤ 10mA | T _A = +25°C | 2 | 10 | ppm/mA | |
| | | | T _A = -40°C to +125°C | 2 | 15 | | |
| | | | Sinking: -0.6mA ≤ I _{OUT} ≤ 0 | T _A = +25°C | 50 | | 500 |
| | | | | T _A = -40°C to +125°C | 90 | | 900 |
| Output Short-Circuit Current | I _{SC} | OUT shorted to GND | | 60 | | mA | |
| | | OUT shorted to IN | | 3 | | | |
| Temperature Hysteresis (Note 4) | ΔV _{OUT} /cycle | | | 120 | | ppm | |
| Long-Term Stability | ΔV _{OUT} /time | 1000 hours at T _A = +25°C | | 50 | | ppm | |
| DYNAMIC | | | | | | | |
| Noise Voltage | e _{OUT} | f = 0.1Hz to 10Hz | | 3.8 | | μV _{P-P} | |
| | | f = 10Hz to 1kHz | | 6.8 | | μV _{RMS} | |
| Turn-On Settling Time | t _{TR} | To V _{OUT} = 0.1% of final value, C _{OUT} = 50pF | | 150 | | μs | |
| INPUT | | | | | | | |
| Supply Voltage Range | V _{IN} | Guaranteed by line regulation test | 4.5 | | 40.0 | V | |
| Quiescent Supply Current | I _{IN} | No load, normal operation | T _A = +25°C | 300 | 450 | μA | |
| | | | T _A = -40°C to +125°C | | 600 | | |
| Shutdown Supply Current | I _{SHDN} | No load, V _{SHDN} < 0.8V | T _A = -40°C to +125°C | 0.01 | 5 | μA | |

High-Precision Voltage Reference with Temperature Sensor

MAX6143

ELECTRICAL CHARACTERISTICS—MAX6143_25 (V_{OUT} = 2.5V) (continued)

(V_{IN} = V_{SHDN} = +5V, T_A = -40°C to +125°C, unless otherwise noted. Typical values are at T_A = +25°C.) (Note 1)

| PARAMETER | SYMBOL | CONDITIONS | MIN | TYP | MAX | UNITS |
|------------------------------|--------------------|------------|-----|-----|-----|-------|
| SHUTDOWN (SHDN) | | | | | | |
| Logic-High Input Voltage | V _{IH} | | 2.0 | | | V |
| Logic-Low Input Voltage | V _{IL} | | | | 0.8 | V |
| Logic-High Input Current | I _{IH} | | | | 20 | μA |
| Logic-Low Input Current | I _{IL} | | | | 2 | μA |
| TEMP OUTPUT | | | | | | |
| TEMP Output Voltage | V _{TEMP} | | | 570 | | mV |
| TEMP Temperature Coefficient | T _{CTEMP} | | | 1.9 | | mV/°C |

ELECTRICAL CHARACTERISTICS—MAX6143_33 (V_{OUT} = 3.3V)

(V_{IN} = V_{SHDN} = +10V, T_A = -40°C to +125°C, unless otherwise noted. Typical values are at T_A = +25°C.) (Note 1)

| PARAMETER | SYMBOL | CONDITIONS | MIN | TYP | MAX | UNITS | |
|---|---------------------------------------|--|----------------------------------|--------|-----|-------------------|---|
| OUTPUT | | | | | | | |
| Output Voltage | V _{OUT} | No load, T _A = +25°C | MAX6143A_33 (0.06%) | 3.2980 | 3.3 | 3.3020 | V |
| | | | MAX6143B_33 (0.1%) | 3.2967 | 3.3 | 3.3033 | |
| Output Adjustment Range | ΔV _{TRIM} | R _{POT} = 10kΩ | ±3 | ±6 | | % | |
| Output-Voltage Temperature Coefficient (Note 2) | T _{CVOUT} | T _A = -40°C to +125°C | MAX6143AASA | 1.5 | 3 | ppm/°C | |
| | | | MAX6143BASA | 3 | 10 | | |
| Line Regulation (Note 3) | ΔV _{OUT} / ΔV _{IN} | 5.3V ≤ V _{IN} ≤ 40V | T _A = +25°C | 0.6 | 5 | ppm/V | |
| | | | T _A = -40°C to +125°C | 0.8 | 10 | | |
| Load Regulation (Note 3) | ΔV _{OUT} / ΔI _{OUT} | Sourcing: 0 ≤ I _{OUT} ≤ 10mA | T _A = +25°C | 2 | 10 | ppm/ mA | |
| | | | T _A = -40°C to +125°C | 2 | 15 | | |
| | | Sinking: -0.6mA ≤ I _{OUT} ≤ 0 | T _A = +25°C | 50 | 500 | | |
| | | | T _A = -40°C to +125°C | 90 | 900 | | |
| Output Short-Circuit Current | I _{SC} | OUT shorted to GND | | 60 | | mA | |
| | | OUT shorted to IN | | 3 | | | |
| Temperature Hysteresis (Note 4) | ΔV _{OUT} / cycle | | | 120 | | ppm | |
| Long-Term Stability | ΔV _{OUT} / time | 1000 hours at T _A = +25°C | | 50 | | ppm | |
| DYNAMIC | | | | | | | |
| Noise Voltage | e _{OUT} | f = 0.1Hz to 10Hz | | 5 | | μV _{P-P} | |
| | | f = 10Hz to 1kHz | | 9.3 | | μV _{RMS} | |
| Turn-On Settling Time | t _R | To V _{OUT} = 0.1% of final value, C _{OUT} = 50pF | | 180 | | μs | |

High-Precision Voltage Reference with Temperature Sensor

ELECTRICAL CHARACTERISTICS—MAX6143_33 (V_{OUT} = 3.3V) (continued)

(V_{IN} = V_{SHDN} = +10V, T_A = -40°C to +125°C, unless otherwise noted. Typical values are at T_A = +25°C.) (Note 1)

| PARAMETER | SYMBOL | CONDITIONS | MIN | TYP | MAX | UNITS |
|------------------------------|---------------------|------------------------------------|----------------------------------|------|------|-------|
| INPUT | | | | | | |
| Supply Voltage Range | V _{IN} | Guaranteed by line regulation test | 5.3 | | 40.0 | V |
| Quiescent Supply Current | I _{IN} | No load, normal operation | T _A = +25°C | 320 | 500 | μA |
| | | | T _A = -40°C to +125°C | | 650 | |
| Shutdown Supply Current | I _{SHDN} | No load, V _{SHDN} < 0.8V | | 0.01 | 5 | μA |
| SHUTDOWN (SHDN) | | | | | | |
| Logic-High Input Voltage | V _{IH} | | 2.0 | | | V |
| Logic-Low Input Voltage | V _{IL} | | | | 0.8 | V |
| Logic-High Input Current | I _{IH} | | | | 20 | μA |
| Logic-Low Input Current | I _{IL} | | | | 2 | μA |
| TEMP OUTPUT | | | | | | |
| TEMP Output Voltage | V _{TEMP} | | | 630 | | mV |
| TEMP Temperature Coefficient | T _C TEMP | | | 2.1 | | mV/°C |

ELECTRICAL CHARACTERISTICS—MAX6143_41 (V_{OUT} = 4.096V)

(V_{IN} = V_{SHDN} = +10V, T_A = -40°C to +125°C, unless otherwise noted. Typical values are at T_A = +25°C.) (Note 1)

| PARAMETER | SYMBOL | CONDITIONS | MIN | TYP | MAX | UNITS | |
|---|--------------------------------------|---|----------------------------------|--------|-------|--------|--------|
| OUTPUT | | | | | | | |
| Output Voltage | V _{OUT} | No load, T _A = +25°C | MAX6143A_41 (0.06%) | 4.0935 | 4.096 | 4.0985 | V |
| | | | MAX6143B_41 (0.1%) | 4.0919 | 4.096 | 4.1001 | |
| Output Adjustment Range | ΔV _{TRIM} | R _{POT} = 10kΩ | ±3 | ±6 | | % | |
| Output-Voltage Temperature Coefficient (Note 2) | T _C V _{OUT} | T _A = -40°C to +125°C | MAX6143AASA | | 1.5 | 3 | ppm/°C |
| | | | MAX6143BASA | | 3 | 10 | |
| Line Regulation (Note 3) | ΔV _{OUT} /ΔV _{IN} | 6.1V ≤ V _{IN} ≤ 40V | T _A = +25°C | | 0.6 | 5 | ppm/V |
| | | | T _A = -40°C to +125°C | | 0.8 | 10 | |
| Load Regulation (Note 3) | ΔV _{OUT} /ΔI _{OUT} | Sourcing: 0 ≤ I _{OUT} ≤ 10mA | T _A = +25°C | | 2 | 10 | ppm/mA |
| | | | T _A = -40°C to +125°C | | 2 | 15 | |
| | | Sinking: -0.6mA ≤ I _{OUT} ≤ 0 | T _A = +25°C | | 50 | 500 | |
| | | | T _A = -40°C to +125°C | | 90 | 900 | |
| Output Short-Circuit Current | I _{SC} | OUT shorted to GND | | 60 | | mA | |
| | | OUT shorted to IN | | 3 | | | |
| Temperature Hysteresis (Note 4) | ΔV _{OUT} /cycle | | | 120 | | ppm | |
| Long-Term Stability | ΔV _{OUT} /time | 1000 hours at T _A = +25°C | | 50 | | ppm | |

High-Precision Voltage Reference with Temperature Sensor

MAX6143

ELECTRICAL CHARACTERISTICS—MAX6143_41 (V_{OUT} = 4.096V) (continued)

(V_{IN} = V_{SHDN} = +10V, T_A = -40°C to +125°C, unless otherwise noted. Typical values are at T_A = +25°C.) (Note 1)

| PARAMETER | SYMBOL | CONDITIONS | | MIN | TYP | MAX | UNITS |
|------------------------------|--------------------|--|----------------------------------|------|-----|------|-------------------|
| DYNAMIC | | | | | | | |
| Noise Voltage | e _{OUT} | f = 0.1Hz to 10Hz | | 7 | | | μV _{P-P} |
| | | f = 10Hz to 1kHz | | 11.5 | | | μV _{RMS} |
| Turn-On Settling Time | t _R | To V _{OUT} = 0.1% of final value, C _{OUT} = 50pF | | 200 | | | μs |
| INPUT | | | | | | | |
| Supply Voltage Range | V _{IN} | Guaranteed by line regulation test | | 6.1 | | 40.0 | V |
| Quiescent Supply Current | I _{IN} | No load, normal operation | T _A = +25°C | 320 | 500 | | μA |
| | | | T _A = -40°C to +125°C | 650 | | | |
| Shutdown Supply Current | I _{SHDN} | No load, V _{SHDN} < 0.8V | T _A = -40°C to +125°C | 0.01 | 5 | | μA |
| SHUTDOWN (SHDN) | | | | | | | |
| Logic-High Input Voltage | V _{IH} | | | 2.0 | | | V |
| Logic-Low Input Voltage | V _{IL} | | | | | 0.8 | V |
| Logic-High Input Current | I _{IH} | | | | | 20 | μA |
| Logic-Low Input Current | I _{IL} | | | | | 2 | μA |
| TEMP OUTPUT | | | | | | | |
| TEMP Output Voltage | V _{TEMP} | | | | 630 | | mV |
| TEMP Temperature Coefficient | TC _{TEMP} | (0.06%) | | | 2.1 | | mV/°C |

ELECTRICAL CHARACTERISTICS—MAX6143_50 (V_{OUT} = 5.0V)

(V_{IN} = V_{SHDN} = +15V, T_A = -40°C to +125°C, unless otherwise noted. Typical values are at T_A = +25°C.) (Note 1)

| PARAMETER | SYMBOL | CONDITIONS | | MIN | TYP | MAX | UNITS |
|---|---------------------------------------|---|----------------------------------|--------|-----|--------|--------|
| OUTPUT | | | | | | | |
| Output Voltage | V _{OUT} | No load, T _A = +25°C | MAX6143A_50 (0.06%) | 4.9970 | 5.0 | 5.0030 | V |
| | | | MAX6143B_50 (0.1%) | 4.9950 | 5.0 | 5.0050 | |
| Output Adjustment Range | ΔV _{TRIM} | R _{POT} = 10kΩ | | ±3 | ±6 | | % |
| Output-Voltage Temperature Coefficient (Note 2) | TC _{VOUT} | T _A = -40°C to +125°C | MAX6143AASA | | 1.5 | 3 | ppm/°C |
| | | | MAX6143BASA | | 3 | 10 | |
| Line Regulation (Note 3) | ΔV _{OUT} / ΔV _{IN} | 7V ≤ V _{IN} ≤ 40V | T _A = +25°C | | 0.6 | 5 | ppm/V |
| | | | T _A = -40°C to +125°C | | 0.8 | 10 | |
| Load Regulation (Note 3) | ΔV _{OUT} / ΔI _{OUT} | Sourcing: 0 ≤ I _{OUT} ≤ 10mA | T _A = +25°C | | 2 | 10 | ppm/mA |
| | | | T _A = -40°C to +125°C | | 2 | 15 | |
| | | Sinking: -0.6mA ≤ I _{OUT} ≤ 0 | T _A = +25°C | | 50 | 500 | |
| | | | T _A = -40°C to +125°C | | 90 | 900 | |

High-Precision Voltage Reference with Temperature Sensor

ELECTRICAL CHARACTERISTICS—MAX6143_50 (V_{OUT} = 5.0V) (continued)

(V_{IN} = V_{SHDN} = +15V, T_A = -40°C to +125°C, unless otherwise noted. Typical values are at T_A = +25°C.) (Note 1)

| PARAMETER | SYMBOL | CONDITIONS | MIN | TYP | MAX | UNITS |
|---------------------------------|--------------------------|--|----------------------------------|------|-----|-------------------|
| Output Short-Circuit Current | I _{SC} | OUT shorted to GND | | 60 | | mA |
| | | OUT shorted to IN | | 3 | | |
| Temperature Hysteresis (Note 4) | ΔV _{OUT} /cycle | | | 120 | | ppm |
| Long-Term Stability | ΔV _{OUT} /time | 1000 hours at T _A = +25°C | | 50 | | ppm |
| DYNAMIC | | | | | | |
| Noise Voltage | e _{OUT} | f = 0.1Hz to 10Hz | | 9 | | μV _{P-P} |
| | | f = 10Hz to 1kHz | | 14.5 | | μV _{RMS} |
| Turn-On Settling Time | t _R | To V _{OUT} = 0.1% of final value, C _{OUT} = 50pF | | 230 | | μs |
| INPUT | | | | | | |
| Supply Voltage Range | V _{IN} | Guaranteed by line regulation test | 7 | | 40 | V |
| Quiescent Supply Current | I _{IN} | No load, normal operation | T _A = +25°C | 320 | 550 | μA |
| | | | T _A = -40°C to +125°C | | 700 | |
| Shutdown Supply Current | I _{SHDN} | No load, V _{SHDN} < 0.8V | | 0.01 | 5 | μA |
| SHUTDOWN (SHDN) | | | | | | |
| Logic-High Input Voltage | V _{IH} | | 2.0 | | | V |
| Logic-Low Input Voltage | V _{IL} | | | | 0.8 | V |
| Logic-High Input Current | I _{IH} | | | | 20 | μA |
| Logic-Low Input Current | I _{IL} | | | | 2 | μA |
| TEMP OUTPUT | | | | | | |
| TEMP Output Voltage | V _{TEMP} | | | 630 | | mV |
| TEMP Temperature Coefficient | TC _{TEMP} | | | 2.1 | | mV/°C |

ELECTRICAL CHARACTERISTICS—MAX6143_10 (V_{OUT} = 10V)

(V_{IN} = V_{SHDN} = +15V, T_A = -40°C to +125°C, unless otherwise noted. Typical values are at T_A = +25°C.) (Note 1)

| PARAMETER | SYMBOL | CONDITIONS | MIN | TYP | MAX | UNITS | |
|---|-------------------------------------|----------------------------------|----------------------------------|-------|------|--------|---|
| OUTPUT | | | | | | | |
| Output Voltage | V _{OUT} | No load, T _A = +25°C | MAX6143A_10 (0.05%) | 9.995 | 10.0 | 10.005 | V |
| | | | MAX6143B_10 (0.1%) | 9.990 | 10.0 | 10.010 | |
| Output Adjustment Range | ΔV _{TRIM} | R _{POT} = 10kΩ | ±3 | ±6 | | % | |
| Output-Voltage Temperature Coefficient (Note 2) | TC _{VOUT} | T _A = -40°C to +125°C | MAX6143AASA | 1.5 | 3 | ppm/°C | |
| | | | MAX6143BASAA | 3 | 10 | | |
| Line Regulation (Note 3) | ΔV _{OUT} /ΔV _{IN} | 12V ≤ V _{IN} ≤ 40V | T _A = +25°C | 0.6 | 5 | ppm/V | |
| | | | T _A = -40°C to +125°C | 0.8 | 10 | | |

High-Precision Voltage Reference with Temperature Sensor

MAX6143

ELECTRICAL CHARACTERISTICS—MAX6143_10 (V_{OUT} = 10V) (continued)

(V_{IN} = V_{SHDN} = +15V, T_A = -40°C to +125°C, unless otherwise noted. Typical values are at T_A = +25°C.) (Note 1)

| PARAMETER | SYMBOL | CONDITIONS | MIN | TYP | MAX | UNITS |
|---------------------------------|---------------------------------|--|----------------------------------|------|-----|-------------------|
| Load Regulation (Note 3) | $\Delta V_{OUT}/\Delta I_{OUT}$ | Sourcing: 0 ≤ I _{OUT} ≤ 10mA | T _A = +25°C | 2 | 10 | ppm/mA |
| | | | T _A = -40°C to +125°C | 2 | 15 | |
| | | Sinking: -0.6mA ≤ I _{OUT} ≤ 0 | T _A = +25°C | 50 | 500 | |
| | | | T _A = -40°C to +125°C | 90 | 900 | |
| Output Short-Circuit Current | I _{SC} | OUT shorted to GND | | 60 | | mA |
| | | OUT shorted to IN | | 3 | | |
| Temperature Hysteresis (Note 4) | $\Delta V_{OUT}/\text{cycle}$ | | | 120 | | ppm |
| Long-Term Stability | $\Delta V_{OUT}/\text{time}$ | 1000 hours at T _A = +25°C | | 50 | | ppm |
| DYNAMIC | | | | | | |
| Noise Voltage | e _{OUT} | f = 0.1Hz to 10Hz | | 18 | | μV _{P-P} |
| | | f = 10Hz to 1kHz | | 29 | | μV _{RMS} |
| Turn-On Settling Time | t _R | To V _{OUT} = 0.1% of final value, C _{OUT} = 50pF | | 400 | | μs |
| INPUT | | | | | | |
| Supply Voltage Range | V _{IN} | Guaranteed by line regulation test | 12 | | 40 | V |
| Quiescent Supply Current | I _{IN} | No load, normal operation | T _A = +25°C | 340 | 550 | μA |
| | | | T _A = -40°C to +125°C | | 700 | |
| Shutdown Supply Current | I _{SHDN} | No load, V _{SHDN} < 0.8V | | 0.01 | 5 | μA |
| SHUTDOWN (SHDN) | | | | | | |
| Logic-High Input Voltage | V _{IH} | | 2.0 | | | V |
| Logic-Low Input Voltage | V _{IL} | | | | 0.8 | V |
| Logic-High Input Current | I _{IH} | | | | 20 | μA |
| Logic-Low Input Current | I _{IL} | | | | 2 | μA |
| TEMP OUTPUT | | | | | | |
| TEMP Output Voltage | V _{TEMP} | | | 630 | | mV |
| TEMP Temperature Coefficient | T _{CTEMP} | | | 2.1 | | mV/°C |

Note 1: All devices are 100% production tested at T_A = +25°C and guaranteed by design over T_A = T_{MIN} to T_{MAX}, as specified.

Note 2: Temperature coefficient is defined as ΔV_{OUT} divided by the temperature range.

Note 3: Line and load regulation specifications do not include the effects of self-heating.

Note 4: Thermal hysteresis is defined as the change in +25°C output voltage before and after cycling the device from T_{MAX} to T_{MIN}.

High-Precision Voltage Reference with Temperature Sensor

Typical Operating Characteristics

($V_{IN} = +5V$ for $V_{OUT} = +2.5V$, $V_{IN} = +15V$ for $V_{OUT} = +10V$, $I_{OUT} = 0$, $T_A = +25^\circ C$, unless otherwise noted.)

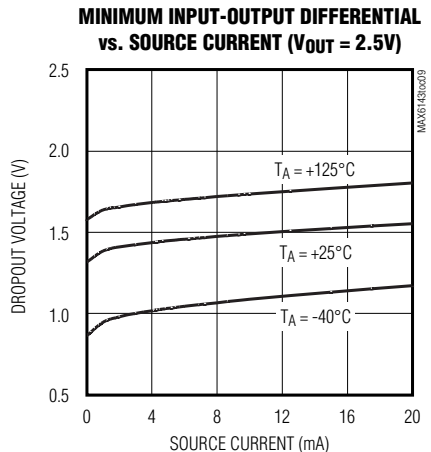
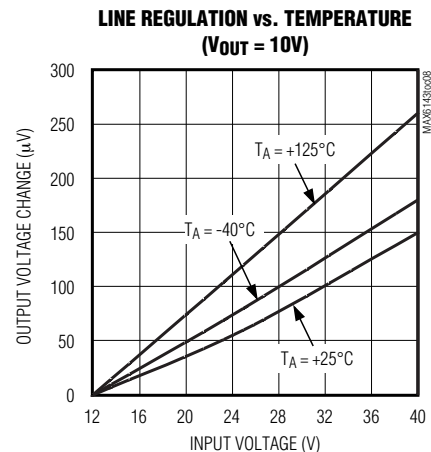
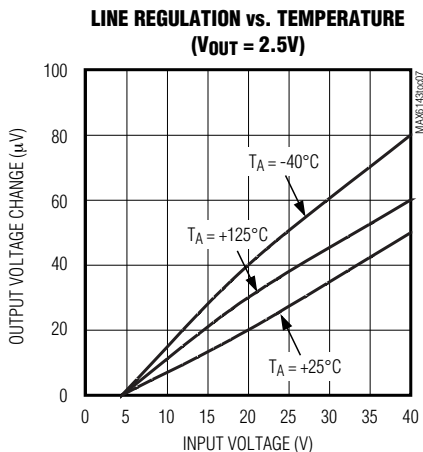
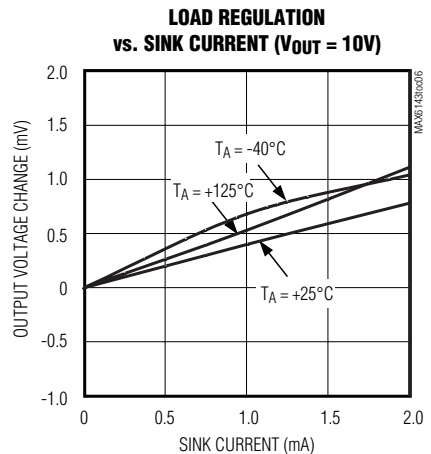
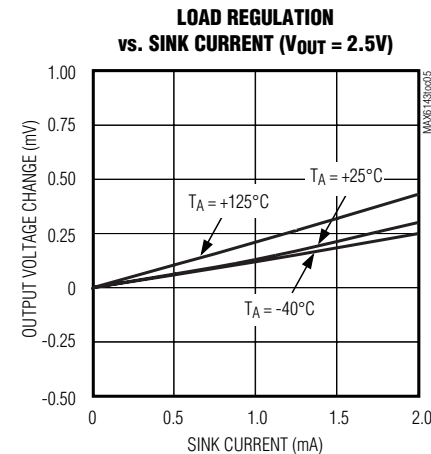
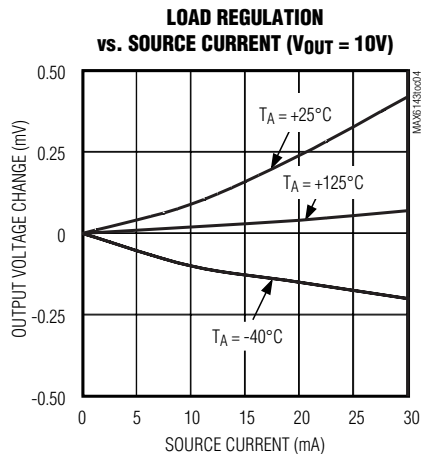
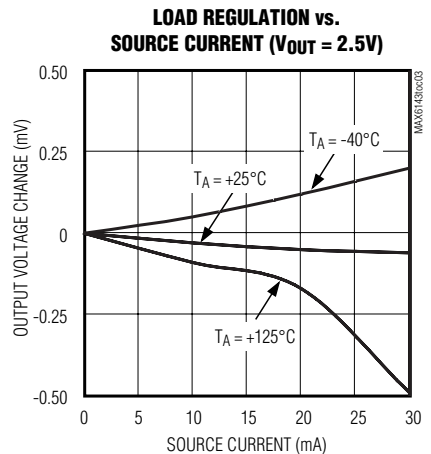
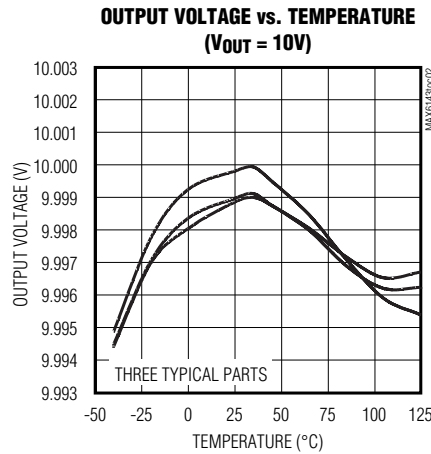
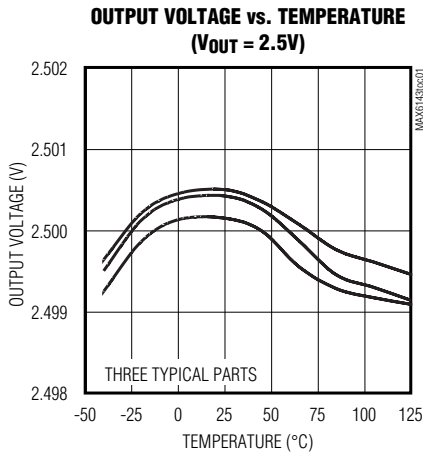

High-Precision Voltage Reference with Temperature Sensor

MAX6143

Typical Operating Characteristics (continued)

($V_{IN} = +5V$ for $V_{OUT} = +2.5V$, $V_{IN} = +15V$ for $V_{OUT} = +10V$, $I_{OUT} = 0$, $T_A = +25^\circ C$, unless otherwise noted.)

MINIMUM INPUT-OUTPUT DIFFERENTIAL vs. SOURCE CURRENT ($V_{OUT} = 10V$)

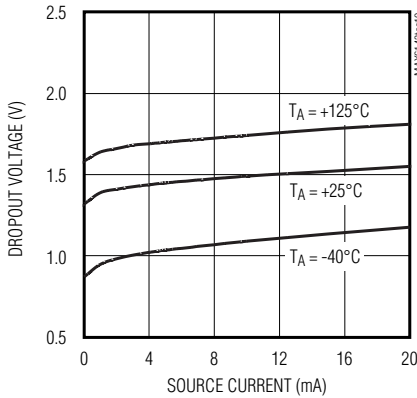

POWER-SUPPLY REJECTION RATIO vs. FREQUENCY ($V_{OUT} = 2.5V$)

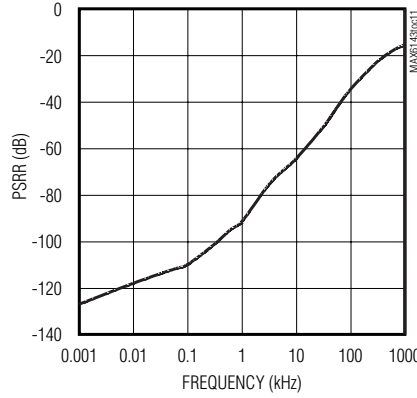

POWER-SUPPLY REJECTION RATIO vs. FREQUENCY ($V_{OUT} = 10V$)

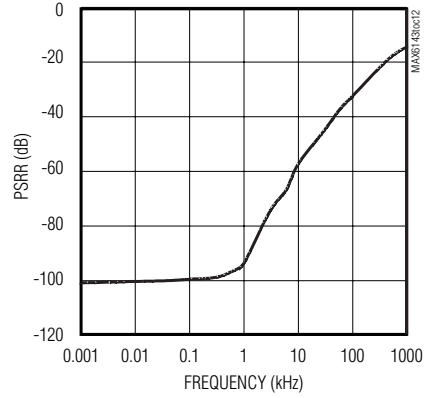

OUTPUT IMPEDANCE vs. FREQUENCY ($V_{OUT} = 2.5V$)

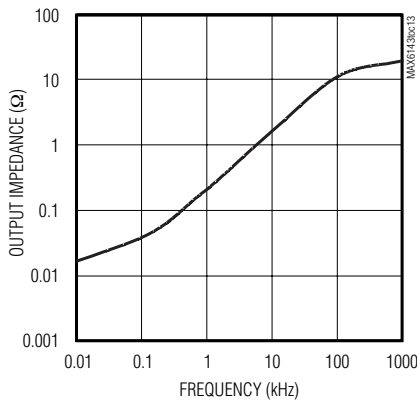

SUPPLY CURRENT vs. INPUT VOLTAGE ($V_{OUT} = 2.5V$)

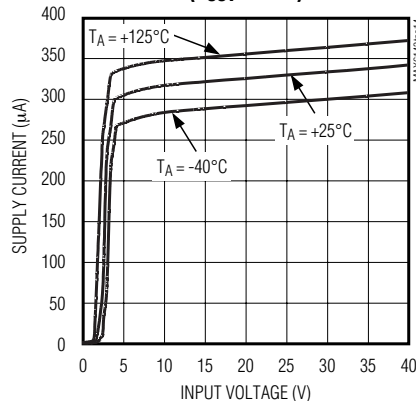

SUPPLY CURRENT vs. INPUT VOLTAGE ($V_{OUT} = 10V$)

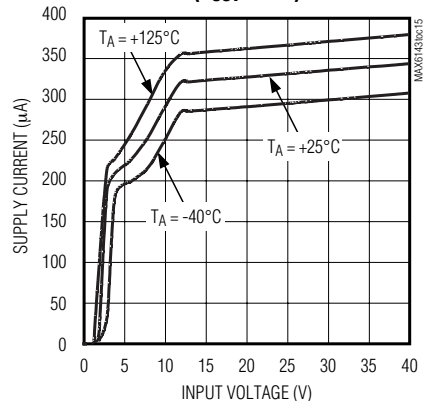

SUPPLY CURRENT vs. TEMPERATURE ($V_{OUT} = 2.5V$)

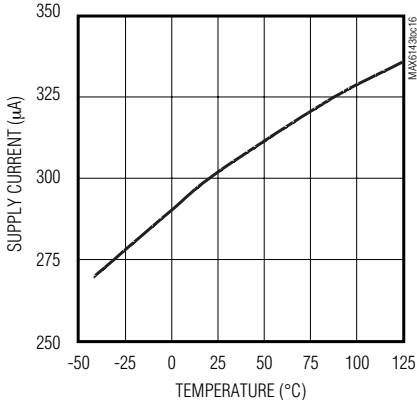

SUPPLY CURRENT vs. TEMPERATURE ($V_{OUT} = 10V$)

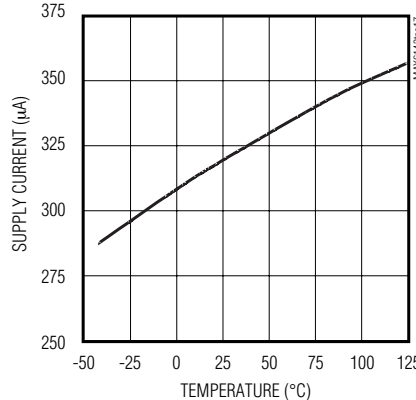

SHUTDOWN SUPPLY CURRENT vs. TEMPERATURE ($V_{OUT} = 2.5V$)

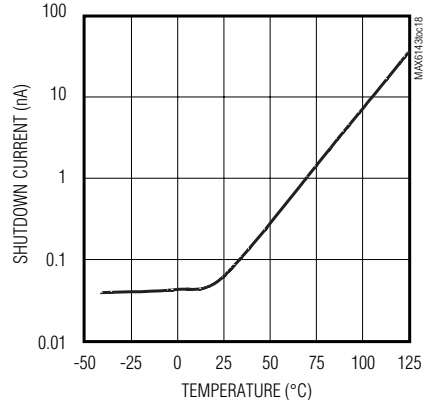

High-Precision Voltage Reference with Temperature Sensor

Typical Operating Characteristics (continued)

($V_{IN} = +5V$ for $V_{OUT} = +2.5V$, $V_{IN} = +15V$ for $V_{OUT} = +10V$, $I_{OUT} = 0$, $T_A = +25^\circ C$, unless otherwise noted.)

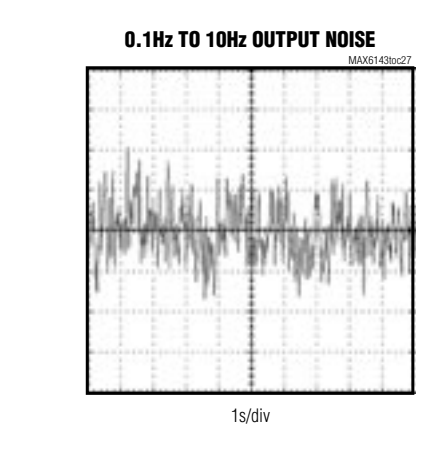
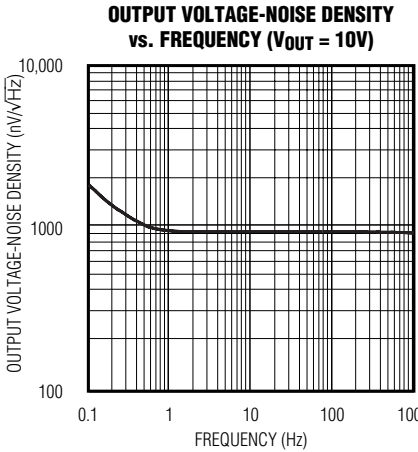
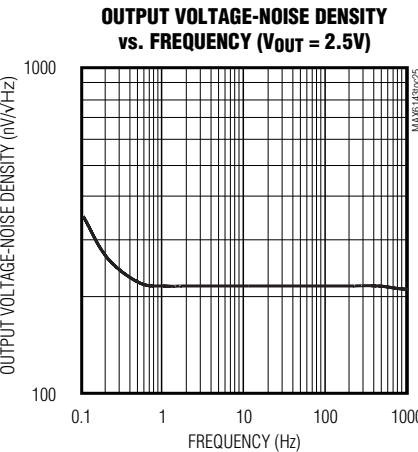
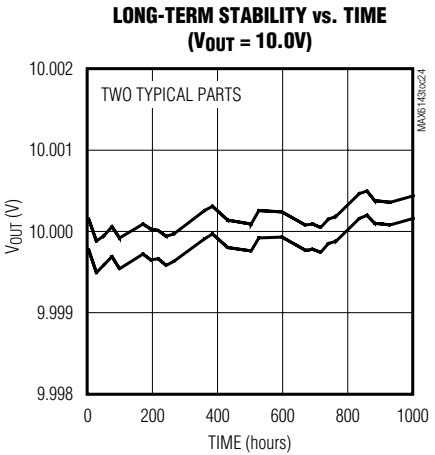
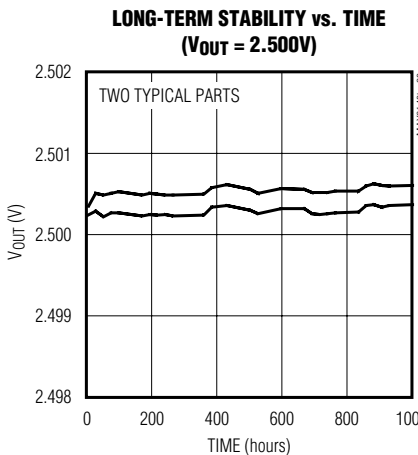
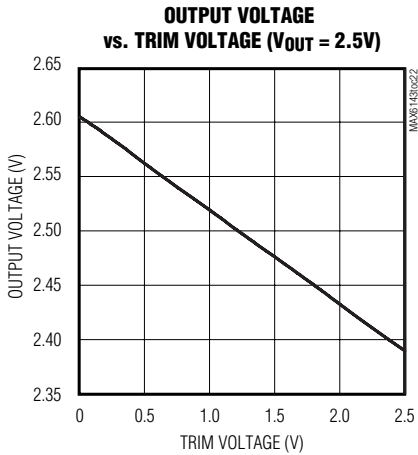
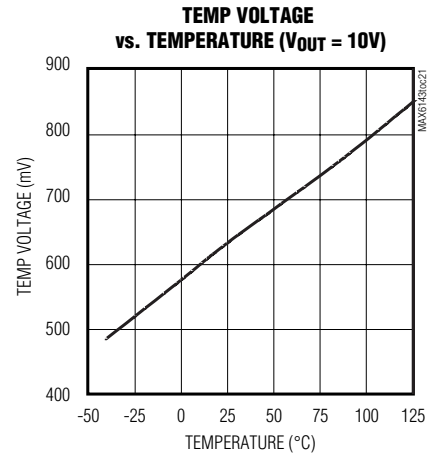
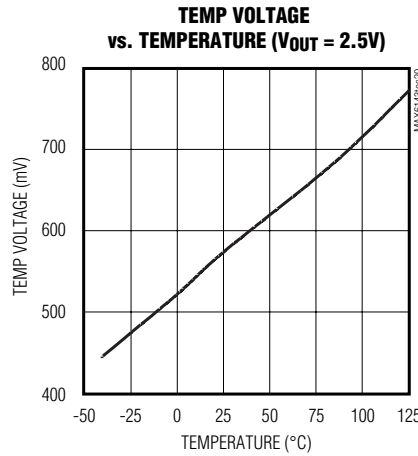
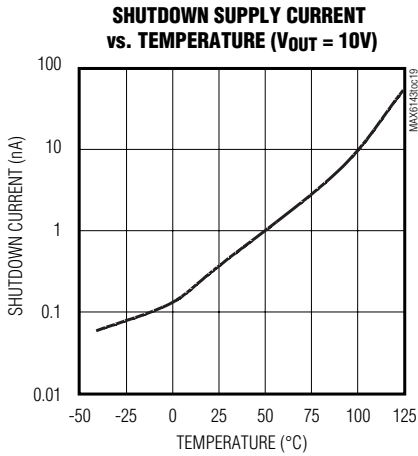

High-Precision Voltage Reference with Temperature Sensor

MAX6143

Typical Operating Characteristics (continued)

($V_{IN} = +5V$ for $V_{OUT} = +2.5V$, $V_{IN} = +15V$ for $V_{OUT} = +10V$, $I_{OUT} = 0$, $T_A = +25^\circ C$, unless otherwise noted.)

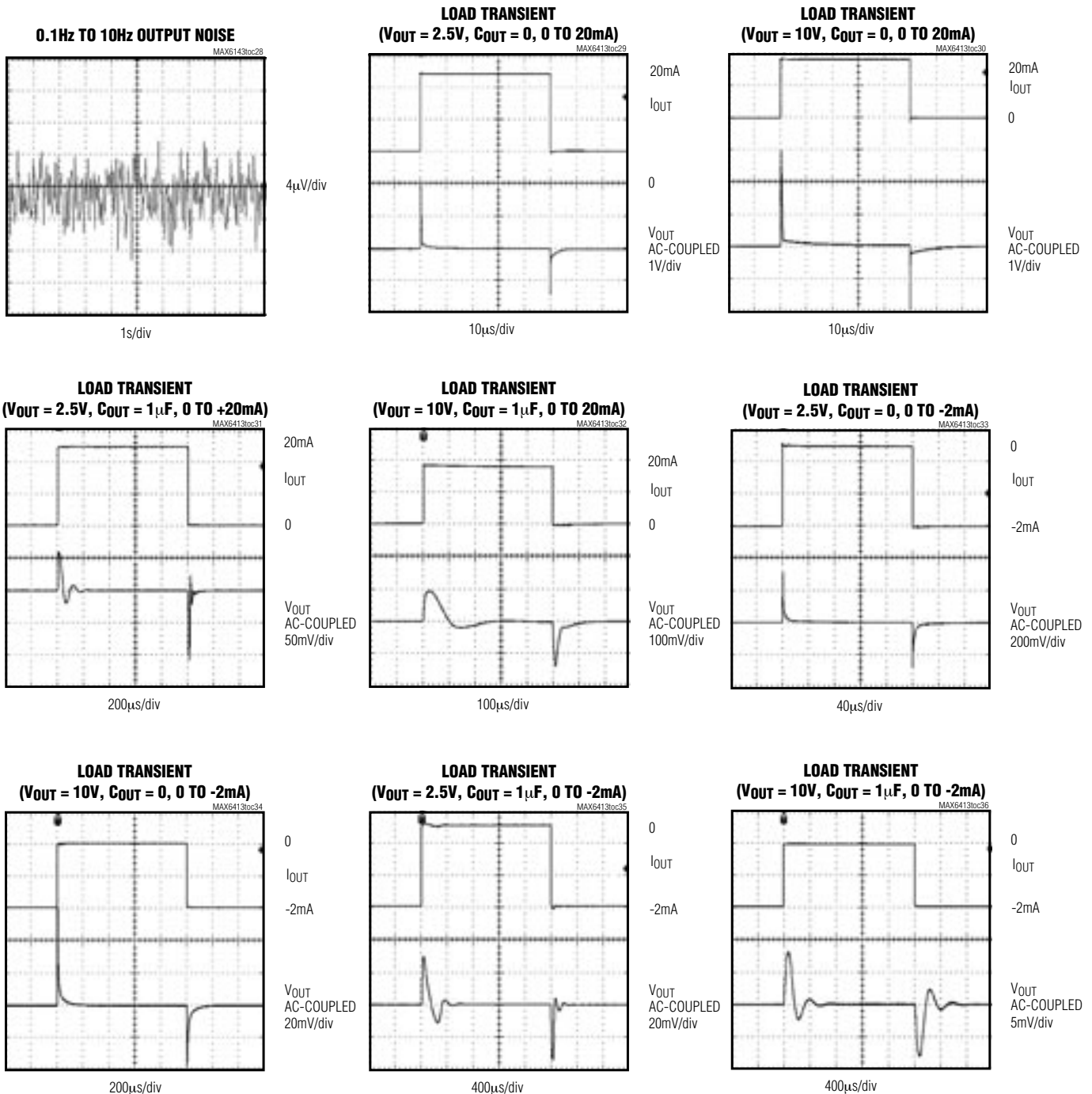

High-Precision Voltage Reference with Temperature Sensor

Typical Operating Characteristics (continued)

($V_{IN} = +5V$ for $V_{OUT} = +2.5V$, $V_{IN} = +15V$ for $V_{OUT} = +10V$, $I_{OUT} = 0$, $T_A = +25^\circ C$, unless otherwise noted.)

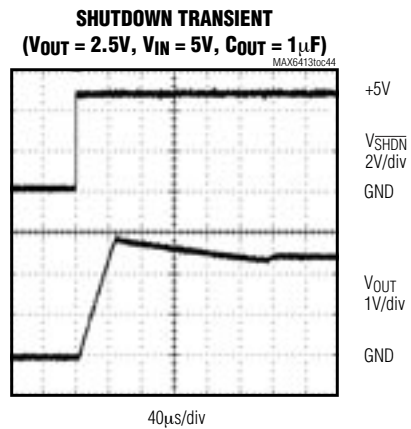
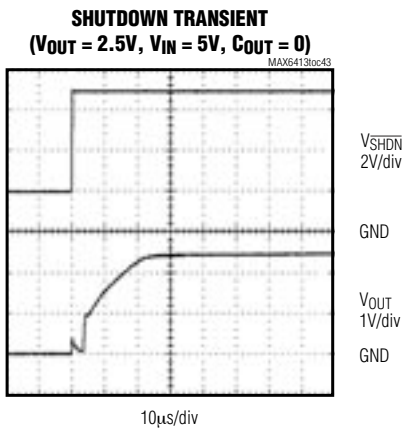
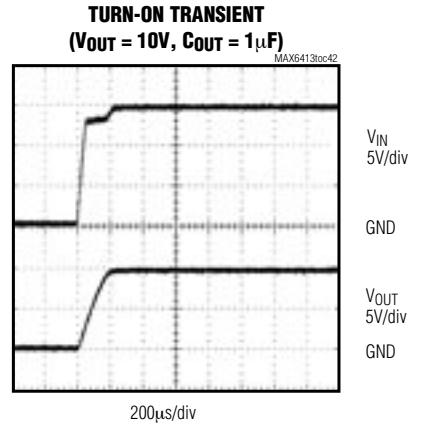
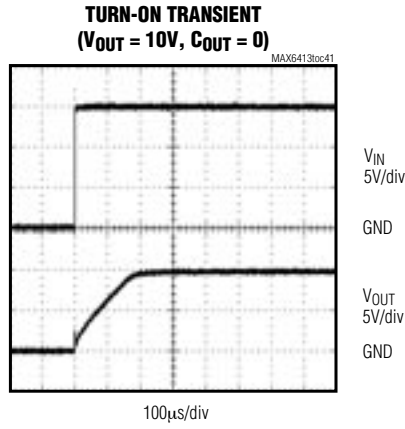
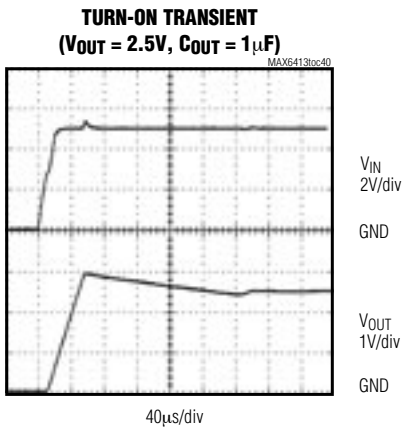
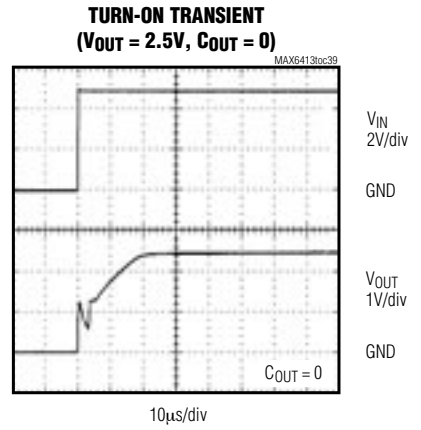
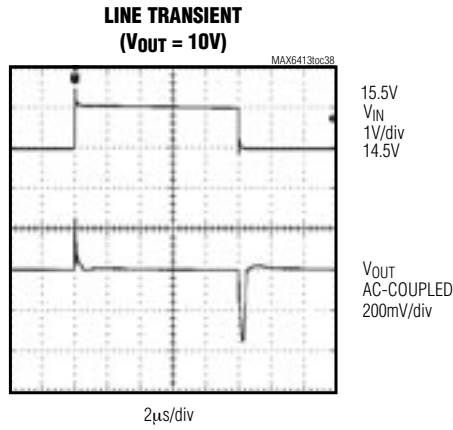
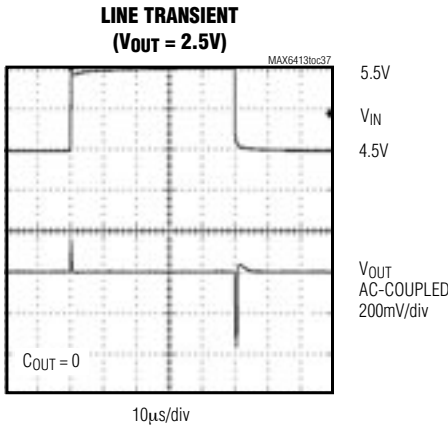

High-Precision Voltage Reference with Temperature Sensor

MAX6143

Typical Operating Characteristics (continued)

($V_{IN} = +5V$ for $V_{OUT} = +2.5V$, $V_{IN} = +15V$ for $V_{OUT} = +10V$, $I_{OUT} = 0$, $T_A = +25^\circ C$, unless otherwise noted.)

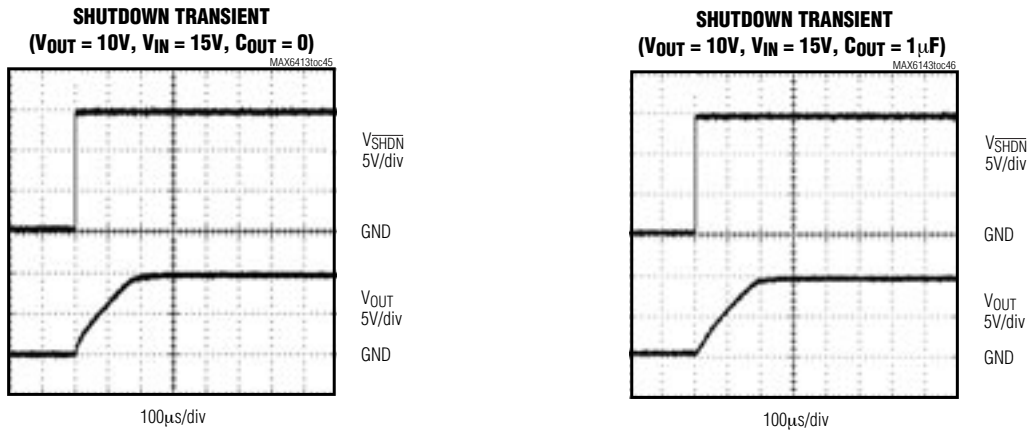

Pin Description

| PIN | NAME | FUNCTION |
|------|------|--|
| 1, 8 | I.C. | Internally Connected. Do not connect externally. |
| 2 | IN | Positive Power-Supply Input |
| 3 | TEMP | Temperature Proportional Output Voltage. TEMP generates an output voltage proportional to the die temperature. |
| 4 | GND | Ground |
| 5 | TRIM | Output Voltage Trim. Connect TRIM to the center of a voltage-divider between OUT and GND for trimming. Leave unconnected to use the preset output voltage. |
| 6 | OUT | Output Voltage |
| 7 | SHDN | Active-Low Shutdown. Connect SHDN to IN for normal operation. |

Detailed Description

The MAX6143 precision voltage reference provides accurate preset +2.5V, +3.3V, +4.096V, +5.0V, and +10V reference voltages from up to +40V input voltages. These devices feature a proprietary temperature-coefficient curvature-correction circuit and laser-trimmed thin-film resistors that result in a very low 3ppm/ $^\circ C$ temperature coefficient and excellent 0.05% initial accuracy. The MAX6143 draws 340 μA of supply current and sources 30mA or sinks 2mA of load current.

Trimming the Output Voltage

Trim the factory-preset output voltage on the MAX6143 by placing a resistive-divider network between OUT, TRIM, and GND. Use the following formula to calculate the change in output voltage from its preset value:

$$\Delta V_{OUT} = 2 \times (V_{TRIM} - V_{TRIM(open)}) \times k$$

where:

$$V_{TRIM} = 0 \text{ to } V_{OUT}$$

$$V_{TRIM(open)} = V_{OUT(nominal)} / 2 \text{ (typ)}$$

$$k = \pm 6\% \text{ typ}$$

For example, use a 50k Ω potentiometer (such as the MAX5436) between OUT, TRIM, and GND with the potentiometer wiper connected to TRIM (see Figure 2). As the TRIM voltage changes from V_{OUT} to GND, the output voltage changes accordingly. Set R2 to 1M Ω or less. Currents through resistors R1 and R2 add to the quiescent supply current.

High-Precision Voltage Reference with Temperature Sensor

Temp Output

The MAX6143 provides a temperature output proportional to die temperature. TEMP can be calculated from the following formula:

$$\text{TEMP (V)} = T_J (\text{°K}) \times n$$

where T_J = the die temperature,

n = the temperature multiplier,

$$n = \frac{V_{\text{TEMP}}(\text{at } T_J = T_0)}{T_0} \approx 1.9\text{mV/°K}$$

T_A = the ambient temperature.

Self-heating affects the die temperature and conversely, the TEMP output. The TEMP equation assumes the output is not loaded. If device power dissipation is negligible, then $T_J \approx T_A$.

Applications Information

Bypassing/Output Capacitance

For the best line-transient performance, decouple the input with a 0.1 μF ceramic capacitor as shown in the *Typical Operating Circuit*. Place the capacitor as close to IN as possible. When transient performance is less important, no capacitor is necessary.

The MAX6143 does not require an output capacitor for stability and is stable with capacitive loads up to 100 μF . In applications where the load or the supply can experience step changes, a larger output capacitor reduces the amount of overshoot (undershoot) and improves the circuit's transient response. Place output capacitors as close to the device as possible for best performance.

Supply Current

The MAX6143 consumes 340 μA of quiescent supply current. This improved efficiency reduces power dissipation and extends battery life.

Shutdown

The active-low shutdown feature reduces supply current to 0.01 μA (typ), further extending battery life. Connect $\overline{\text{SHDN}}$ to GND to activate shutdown. Connect $\overline{\text{SHDN}}$ to IN for normal operation.

Thermal Hysteresis

Thermal hysteresis is the change in the output voltage at $T_A = +25^\circ\text{C}$ before and after the device is cycled over its entire operating temperature range. Hysteresis is caused by differential package stress appearing across the bandgap core transistors. The typical thermal hysteresis value is 120ppm.

Turn-On Time

The MAX6143 typically turns on and settles to within 0.1% of the preset output voltage in 150 μs (2.5V output). The turn-on time can increase up to 150 μs with the device operating at a 1 μF load.

Short-Circuited Outputs

The MAX6143 features a short-circuit-protected output. Internal circuitry limits the output current to 60mA when short circuiting the output to ground. The output current is limited to 3mA when short circuiting the output to the input.

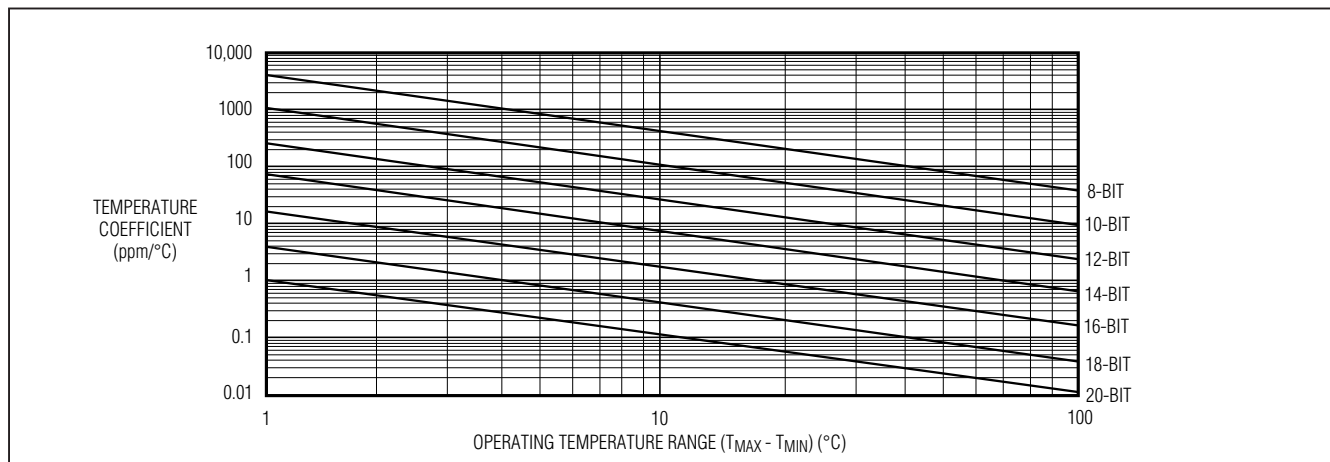

Figure 1. Temperature Coefficient vs. Operating Temperature Range for a 1 LSB Maximum Error

High-Precision Voltage Reference with Temperature Sensor

Temperature Coefficient vs. Operating Temperature Range for a 1 LSB Maximum Error

In a data converter application, the reference voltage of the converter must stay within a certain limit to keep the error in the data converter smaller than the resolution limit through the operating temperature range. Figure 1 shows the maximum allowable reference-voltage temperature coefficient to keep the conversion error to less than 1 LSB, as a function of the operating temperature range ($T_{MAX} - T_{MIN}$) with the converter resolution as a parameter. The graph assumes the reference-voltage temperature coefficient as the only parameter affecting accuracy.

In reality, the absolute static accuracy of a data converter is dependent on the combination of many parameters such as integral nonlinearity, differential nonlinearity, offset error, gain error, as well as voltage-reference changes.

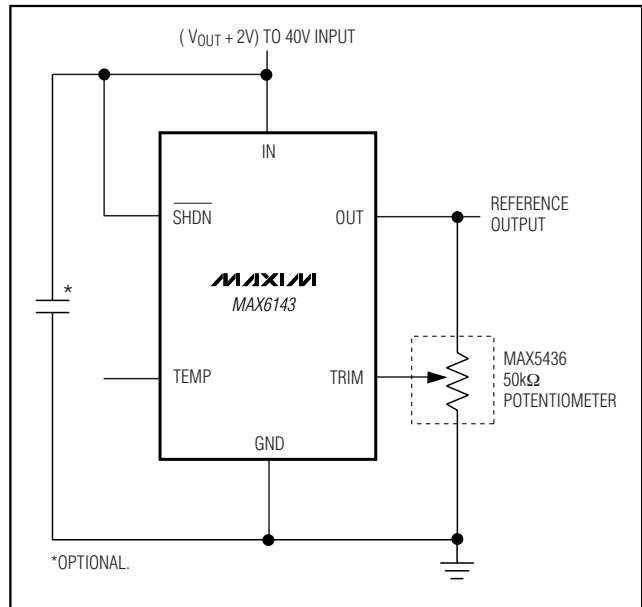
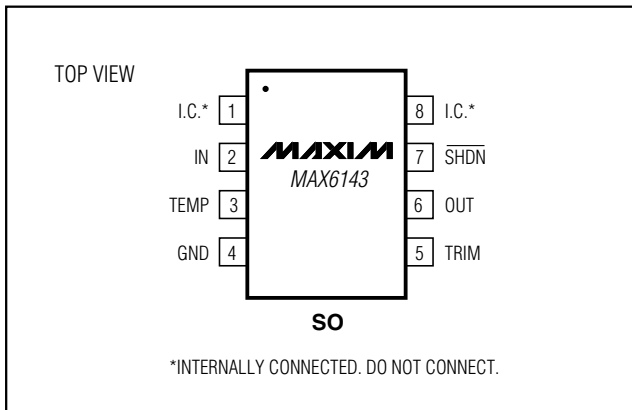

Figure 2. Applications Circuit Using the MAX5436 Potntiometer

MAX6143

Pin Configuration



Chip Information

TRANSISTOR COUNT: 429
PROCESS: BiCMOS

High-Precision Voltage Reference with Temperature Sensor

Package Information

(The package drawing(s) in this data sheet may not reflect the most current specifications. For the latest package outline information go to www.maxim-ic.com/packages.)

| DIM | INCHES | | MILLIMETERS | |
|-----|-----------|-------|-------------|------|
| | MIN | MAX | MIN | MAX |
| A | 0.053 | 0.069 | 1.35 | 1.75 |
| A1 | 0.004 | 0.010 | 0.10 | 0.25 |
| B | 0.014 | 0.019 | 0.35 | 0.49 |
| C | 0.007 | 0.010 | 0.19 | 0.25 |
| e | 0.050 BSC | | 1.27 BSC | |
| E | 0.150 | 0.157 | 3.80 | 4.00 |
| H | 0.228 | 0.244 | 5.80 | 6.20 |
| L | 0.016 | 0.050 | 0.40 | 1.27 |

VARIATIONS:

| DIM | INCHES | | MILLIMETERS | | N | MS012 |
|-----|--------|-------|-------------|-------|----|-------|
| | MIN | MAX | MIN | MAX | | |
| D | 0.189 | 0.197 | 4.80 | 5.00 | 8 | AA |
| D | 0.337 | 0.344 | 8.55 | 8.75 | 14 | AB |
| D | 0.386 | 0.394 | 9.80 | 10.00 | 16 | AC |

TOP VIEW

FRONT VIEW

SIDE VIEW

NOTES:

1. D&E DO NOT INCLUDE MOLD FLASH.
2. MOLD FLASH OR PROTRUSIONS NOT TO EXCEED 0.15mm (.006").
3. LEADS TO BE COPLANAR WITHIN 0.10mm (.004").
4. CONTROLLING DIMENSION: MILLIMETERS.
5. MEETS JEDEC MS012.
6. N = NUMBER OF PINS.

DALLAS SEMICONDUCTOR **MAXIM**

PROPRIETARY INFORMATION

TITLE: PACKAGE OUTLINE, .150" SOIC

| | | | |
|----------|---------------------------------|-----------|-----|
| APPROVAL | DOCUMENT CONTROL NO. 21-0041 | REV. B | 1/1 |
|----------|---------------------------------|-----------|-----|

Maxim cannot assume responsibility for use of any circuitry other than circuitry entirely embodied in a Maxim product. No circuit patent licenses are implied. Maxim reserves the right to change the circuitry and specifications without notice at any time.

16 Maxim Integrated Products, 120 San Gabriel Drive, Sunnyvale, CA 94086 408-737-7600

Looking for pricing, stock, or lifecycle information?

Click below to explore more details on WIN SOURCE:

- ⊖ [View MAX6143AASA50+T on WIN SOURCE](#)
- ⊖ [Maxim Integrated Information](#)

Optimize Your Supply Chain with WIN SOURCE Solutions

- ✓ Global Sourcing Solution
- ✓ Obsolete Management
- ✓ Cost Control Management
- ✓ Shortage Management
- ✓ Alternative Solution
- ✓ Excess Inventory Management