



**THE DATASHEET OF
MAX6034AEXR30+T**





Precision, Micropower, Low-Dropout, SC70 Series Voltage Reference

MAX6034

General Description

The MAX6034 family of precision, low-dropout, micropower voltage references are available in the miniature 3-pin SC70 surface-mount package. They feature a proprietary temperature coefficient curvature-correction circuit and laser-trimmed, thin-film resistors that result in a low temperature coefficient of 30ppm/°C (max) and initial accuracy of $\pm 0.20\%$ (max). These devices are available over the extended temperature range of -40°C to $+85^{\circ}\text{C}$.

The MAX6034 family of series-mode voltage references typically draw only $90\mu\text{A}$ of supply current and can source 1mA and sink $200\mu\text{A}$ of load current. Unlike conventional shunt-mode (two terminal) references that waste supply current and require an external resistor, devices in the MAX6034 family offer supply current that is virtually independent of supply voltage ($16\mu\text{A}/\text{V}$, max variation) and do not require an external resistor. These internally compensated devices do not require an external compensation capacitor, but are stable with up to $1\mu\text{F}$ of load capacitance. Eliminating the external compensation capacitor saves valuable board space in space-critical applications. The low dropout voltage and supply-independent, ultra-low supply current make the MAX6034 ideal for battery-powered applications.

Applications

Hand-Held Equipment
Data-Acquisition Systems
Industrial and Process Control Systems
Battery-Operated Equipment
Hard-Disk Drives

Typical Operating Circuit

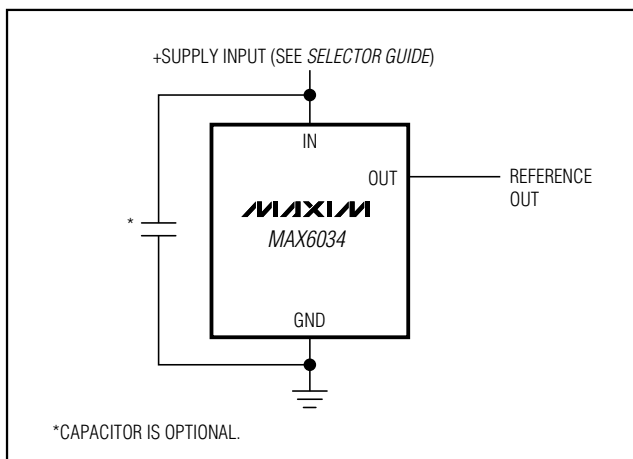

Features

- ◆ Ultra-Small, 3-Pin SC70 Package
- ◆ $\pm 0.2\%$ (max) Initial Accuracy
- ◆ 30ppm/°C (max) Temperature Coefficient
- ◆ $90\mu\text{A}$ Supply Current
- ◆ 200mV (max) Dropout Voltage at 1mA Load Current
- ◆ Stable with $C_{\text{LOAD}} = 0$ to $1\mu\text{F}$
- ◆ No Output Capacitor Needed

Ordering Information

PART	TEMP RANGE	PIN-PACKAGE	TOP MARK
MAX6034AEXR21-T	-40°C to $+85^{\circ}\text{C}$	3 SC70-3	AJH
MAX6034BEXR21-T	-40°C to $+85^{\circ}\text{C}$	3 SC70-3	AJM
MAX6034AEXR25-T	-40°C to $+85^{\circ}\text{C}$	3 SC70-3	AJI
MAX6034BEXR25-T	-40°C to $+85^{\circ}\text{C}$	3 SC70-3	AJN
MAX6034AEXR30-T	-40°C to $+85^{\circ}\text{C}$	3 SC70-3	AJJ
MAX6034BEXR30-T	-40°C to $+85^{\circ}\text{C}$	3 SC70-3	AJO
MAX6034AEXR33-T	-40°C to $+85^{\circ}\text{C}$	3 SC70-3	AJK
MAX6034BEXR33-T	-40°C to $+85^{\circ}\text{C}$	3 SC70-3	AJP
MAX6034AEXR41-T	-40°C to $+85^{\circ}\text{C}$	3 SC70-3	AJL
MAX6034BEXR41-T	-40°C to $+85^{\circ}\text{C}$	3 SC70-3	AJQ

Selector Guide

PART	V_{OUT}	INPUT VOLTAGE (V)
MAX6034_EXR21-T	2.048	2.5 to 5.5
MAX6034_EXR25-T	2.500	($V_{\text{OUT}} + 200\text{mV}$) to 5.5
MAX6034_EXR30-T	3.000	($V_{\text{OUT}} + 200\text{mV}$) to 5.5
MAX6034_EXR33-T	3.300	($V_{\text{OUT}} + 200\text{mV}$) to 5.5
MAX6034_EXR41-T	4.096	($V_{\text{OUT}} + 200\text{mV}$) to 5.5

Pin Configuration

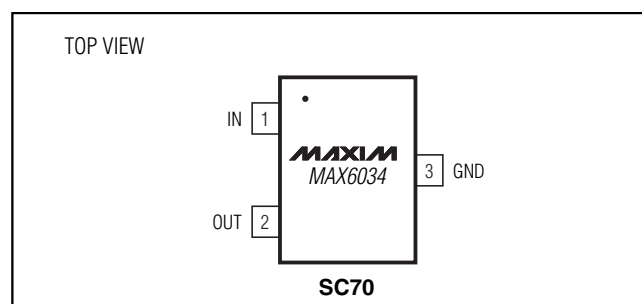

MAXIM

Maxim Integrated Products 1

For pricing, delivery, and ordering information, please contact Maxim/Dallas Direct! at 1-888-629-4642, or visit Maxim's website at www.maxim-ic.com.

Precision, Micropower, Low-Dropout, SC70 Series Voltage Reference

ABSOLUTE MAXIMUM RATINGS

(Voltages Referenced to GND)

IN-0.3V to +6.0V
 OUT-0.3V to ($V_{IN} + 0.3V$)
 Output Short Circuit to GND or IN.....Continuous
 Continuous Power Dissipation ($T_A = +70^\circ\text{C}$)
 3-Pin SC70 (derate 2.9mW/ $^\circ\text{C}$ above $+70^\circ\text{C}$).....235mW

Operating Temperature Range-40 $^\circ\text{C}$ to +85 $^\circ\text{C}$

Junction Temperature+150 $^\circ\text{C}$

Storage Temperature Range-65 $^\circ\text{C}$ to +150 $^\circ\text{C}$

Lead Temperature (soldering, 10s)+300 $^\circ\text{C}$

Stresses beyond those listed under "Absolute Maximum Ratings" may cause permanent damage to the device. These are stress ratings only, and functional operation of the device at these or any other conditions beyond those indicated in the operational sections of the specifications is not implied. Exposure to absolute maximum rating conditions for extended periods may affect device reliability.

ELECTRICAL CHARACTERISTICS—MAX6034_21 ($V_{OUT} = 2.048V$)

($V_{IN} = 2.7V$, $I_{OUT} = 0$, $T_A = T_{MIN}$ to T_{MAX} , unless otherwise noted. Typical values are at $T_A = +25^\circ\text{C}$.) (Note 1)

PARAMETER	SYMBOL	CONDITIONS	MIN	TYP	MAX	UNITS	
OUTPUT							
Output Voltage	V_{OUT}	$T_A = +25^\circ\text{C}$	MAX6034A_21 ($\pm 0.2\%$)	2.044	2.048	2.052	V
			MAX6034B_21 ($\pm 0.4\%$)	2.040	2.048	2.056	
Output Voltage Temperature Coefficient (Note 2)	TCV_{OUT}	MAX6034A_21		7	30	ppm/ $^\circ\text{C}$	
		MAX6034B_21		7	75		
Line Regulation	$\frac{\Delta V_{OUT}}{\Delta V_{IN}}$	$2.5V \leq V_{IN} \leq 5.5V$		33	220	$\mu\text{V/V}$	
Load Regulation	$\frac{\Delta V_{OUT}}{\Delta I_{OUT}}$	Sourcing: $0 \leq I_{OUT} \leq 1\text{mA}$		0.25	1.0	mV/mA	
		Sinking: $0 \leq I_{OUT} \leq 200\mu\text{A}$		2.1	62		
OUT Short-Circuit Current	I_{SC}	Short to GND		12		mA	
		Short to IN		4			
Temperature Hysteresis	$\frac{\Delta V_{OUT}}{\text{cycle}}$	(Note 3)		100		ppm	
Long-Term Stability	$\frac{\Delta V_{OUT}}{\text{time}}$	1000hr at $T_A = +25^\circ\text{C}$		90		ppm/1000hr	
DYNAMIC							
Noise Voltage	e_{OUT}	$f = 0.1\text{Hz to }10\text{Hz}$		45		μV_{P-P}	
		$f = 10\text{Hz to }10\text{kHz}$		46		μV_{RMS}	
Ripple Rejection	$\frac{\Delta V_{OUT}}{\Delta V_{IN}}$	$V_{IN} = 2.7V \pm 100\text{mV}$, $f = 120\text{Hz}$		80		dB	
Turn-On Settling Time	t_R	To $V_{OUT} = 0.1\%$ of final value, $C_{OUT} = 50\text{pF}$		85		μs	
Capacitive-Load Stability Range	C_{OUT}	(Note 4)	0		1	μF	
INPUT							
Supply Voltage Range	V_{IN}	Guaranteed by line-regulation test	2.5		5.5	V	
Quiescent Supply Current	I_{IN}			85	115	μA	
Change in Supply Current Per Change in Input Voltage	$\frac{\Delta I_{IN}}{\Delta V_{IN}}$	$2.5V \leq V_{IN} \leq 5.5V$		4.1	16	$\mu\text{A/V}$	

Precision, Micropower, Low-Dropout, SC70 Series Voltage Reference

MAX6034

ELECTRICAL CHARACTERISTICS—MAX6034_25 (V_{OUT} = 2.500V)

(V_{IN} = 2.7V, I_{OUT} = 0, T_A = T_{MIN} to T_{MAX}, unless otherwise noted. Typical values are at T_A = +25°C.) (Note 1)

PARAMETER	SYMBOL	CONDITIONS	MIN	TYP	MAX	UNITS	
OUTPUT							
Output Voltage	V _{OUT}	T _A = +25°C	MAX6034A_25 (±0.2%)	2.495	2.500	2.505	V
			MAX6034B_25 (±0.4%)	2.490	2.500	2.510	
Output Voltage Temperature Coefficient (Note 2)	TCV _{OUT}	MAX6034A_25		7	30	ppm/°C	
		MAX6034B_25		7	75		
Line Regulation	$\frac{\Delta V_{OUT}}{\Delta V_{IN}}$	(V _{OUT} + 200mV) ≤ V _{IN} ≤ 5.5V		40	250	μV/V	
Load Regulation	$\frac{\Delta V_{OUT}}{\Delta I_{OUT}}$	Sourcing: 0 ≤ I _{OUT} ≤ 1mA		0.22	1.0	mV/mA	
		Sinking: 0 ≤ I _{OUT} ≤ 200μA		2.5	8		
OUT Short-Circuit Current	I _{SC}	Short to GND		12		mA	
		Short to IN		4			
Dropout Voltage	V _{IN} - V _{OUT}	I _{OUT} = 1mA (Note 5)		70	200	mV	
Temperature Hysteresis	$\frac{\Delta V_{OUT}}{\text{cycle}}$	(Note 3)		100		ppm	
Long-Term Stability	$\frac{\Delta V_{OUT}}{\text{time}}$	1000hr at T _A = +25°C		90		ppm/1000hr	
DYNAMIC							
Noise Voltage	e _{OUT}	f = 0.1Hz to 10Hz		55		μV _{P-P}	
		f = 10Hz to 10kHz		64		μV _{RMS}	
Ripple Rejection	$\frac{\Delta V_{OUT}}{\Delta V_{IN}}$	V _{IN} = 2.7V ±100mV, f = 120Hz		80		dB	
Turn-On Settling Time	t _R	To V _{OUT} = 0.1% of final value, C _{OUT} = 50pF		140		μs	
Capacitive-Load Stability Range	C _{OUT}	(Note 4)	0		1	μF	
INPUT							
Supply Voltage Range	V _{IN}	Guaranteed by line-regulation test	V _{OUT} + 0.2		5.5	V	
Quiescent Supply Current	I _{IN}			85	115	μA	
Change in Supply Current Per Change in Input Voltage	$\frac{\Delta I_{IN}}{\Delta V_{IN}}$	(V _{OUT} + 200mV) ≤ V _{IN} ≤ 5.5V		4.2	16	μA/V	

Precision, Micropower, Low-Dropout, SC70 Series Voltage Reference

ELECTRICAL CHARACTERISTICS—MAX6034_30 (V_{OUT} = 3.000V)

(V_{IN} = 5V, I_{OUT} = 0, T_A = T_{MIN} to T_{MAX}, unless otherwise noted. Typical values are at T_A = +25°C.) (Note 1)

PARAMETER	SYMBOL	CONDITIONS	MIN	TYP	MAX	UNITS	
OUTPUT							
Output Voltage	V _{OUT}	T _A = +25°C	MAX6034A_30 (±0.2%)	2.994	3.000	3.006	V
			MAX6034B_30 (±0.4%)	2.988	3.000	3.012	
Output Voltage Temperature Coefficient (Note 2)	TCV _{OUT}	MAX6034A_30		7	30	ppm/°C	
		MAX6034B_30		7	75		
Line Regulation	$\frac{\Delta V_{OUT}}{\Delta V_{IN}}$	(V _{OUT} + 200mV) ≤ V _{IN} ≤ 5.5V		43	280	μV/V	
Load Regulation	$\frac{\Delta V_{OUT}}{\Delta I_{OUT}}$	Sourcing: 0 ≤ I _{OUT} ≤ 1mA		0.30	1.3	mV/mA	
		Sinking: 0 ≤ I _{OUT} ≤ 200μA		2.6	8		
OUT Short-Circuit Current	I _{SC}	Short to GND		13		mA	
		Short to IN		4			
Dropout Voltage	V _{IN} - V _{OUT}	I _{OUT} = 1mA (Note 5)		70	200	mV	
Temperature Hysteresis	$\frac{\Delta V_{OUT}}{\text{cycle}}$	(Note 3)		100		ppm	
Long-Term Stability	$\frac{\Delta V_{OUT}}{\text{time}}$	1000hr at T _A = +25°C		90		ppm/1000hr	
DYNAMIC							
Noise Voltage	e _{OUT}	f = 0.1Hz to 10Hz		66		μV _{P-P}	
		f = 10Hz to 10kHz		80		μV _{RMS}	
Ripple Rejection	$\frac{\Delta V_{OUT}}{\Delta V_{IN}}$	V _{IN} = 5V ±100mV, f = 120Hz		76		dB	
Turn-On Settling Time	t _R	To V _{OUT} = 0.1% of final value, C _{OUT} = 50pF		165		μs	
Capacitive-Load Stability Range	C _{OUT}	(Note 4)	0		1	μF	
INPUT							
Supply Voltage Range	V _{IN}	Guaranteed by line-regulation test	V _{OUT} + 0.2		5.5	V	
Quiescent Supply Current	I _{IN}			95	125	μA	
Change in Supply Current Per Change in Input Voltage	$\frac{\Delta I_{IN}}{\Delta V_{IN}}$	(V _{OUT} + 200mV) ≤ V _{IN} ≤ 5.5V		4.5	16	μA/V	

Precision, Micropower, Low-Dropout, SC70 Series Voltage Reference

MAX6034

ELECTRICAL CHARACTERISTICS—MAX6034_33 (V_{OUT} = 3.300V)

(V_{IN} = 5V, I_{OUT} = 0, T_A = T_{MIN} to T_{MAX}, unless otherwise noted. Typical values are at T_A = +25°C.) (Note 1)

PARAMETER	SYMBOL	CONDITIONS	MIN	TYP	MAX	UNITS	
OUTPUT							
Output Voltage	V _{OUT}	T _A = +25°C	MAX6034A_33 (±0.2%)	3.293	3.300	3.307	V
			MAX6034B_33 (±0.4%)	3.287	3.300	3.313	
Output Voltage Temperature Coefficient (Note 2)	TCV _{OUT}	MAX6034A_33		7	30	ppm/°C	
		MAX6034B_33		7	75		
Line Regulation	$\frac{\Delta V_{OUT}}{\Delta V_{IN}}$	(V _{OUT} + 200mV) ≤ V _{IN} ≤ 5.5V		45	300	μV/V	
Load Regulation	$\frac{\Delta V_{OUT}}{\Delta I_{OUT}}$	Sourcing: 0 ≤ I _{OUT} ≤ 1mA		0.3	1.3	mV/mA	
		Sinking: 0 ≤ I _{OUT} ≤ 200μA		3	8.6		
OUT Short-Circuit Current	I _{SC}	Short to GND		13		mA	
		Short to IN		4			
Dropout Voltage	V _{IN} - V _{OUT}	I _{OUT} = 1mA (Note 5)		70	200	mV	
Temperature Hysteresis	$\frac{\Delta V_{OUT}}{\text{cycle}}$	(Note 3)		100		ppm	
Long-Term Stability	$\frac{\Delta V_{OUT}}{\text{time}}$	1000hr at T _A = +25°C		90		ppm/1000hr	
DYNAMIC							
Noise Voltage	e _{OUT}	f = 0.1Hz to 10Hz		73		μV _{P-P}	
		f = 10Hz to 10kHz		88		μV _{RMS}	
Ripple Rejection	$\frac{\Delta V_{OUT}}{\Delta V_{IN}}$	V _{IN} = 5V ±100mV, f = 120Hz		76		dB	
Turn-On Settling Time	t _R	To V _{OUT} = 0.1% of final value, C _{OUT} = 50pF		200		μs	
Capacitive-Load Stability Range	C _{OUT}	(Note 4)	0		1	μF	
INPUT							
Supply Voltage Range	V _{IN}	Guaranteed by line-regulation test		V _{OUT} + 0.2	5.5	V	
Quiescent Supply Current	I _{IN}			95	125	μA	
Change in Supply Current Per Change in Input Voltage	$\frac{\Delta I_{IN}}{\Delta V_{IN}}$	(V _{OUT} + 200mV) ≤ V _{IN} ≤ 5.5V		3.8	16	μA/V	

Precision, Micropower, Low-Dropout, SC70 Series Voltage Reference

ELECTRICAL CHARACTERISTICS—MAX6034_41 (V_{OUT} = 4.096V)

(V_{IN} = 5V, I_{OUT} = 0, T_A = T_{MIN} to T_{MAX}, unless otherwise noted. Typical values are at T_A = +25°C.) (Note 1)

PARAMETER	SYMBOL	CONDITIONS	MIN	TYP	MAX	UNITS	
OUTPUT							
Output Voltage	V _{OUT}	T _A = +25°C	MAX6034A_41 (±0.2%)	4.088	4.096	4.104	V
			MAX6034B_41 (±0.4%)	4.080	4.096	4.112	
Output Voltage Temperature Coefficient (Note 2)	TCV _{OUT}	MAX6034A_41		7	30	ppm/°C	
		MAX6034B_41		7	75		
Line Regulation	$\frac{\Delta V_{OUT}}{\Delta V_{IN}}$	(V _{OUT} + 200mV) ≤ V _{IN} ≤ 5.5V		50	350	μV/V	
Load Regulation	$\frac{\Delta V_{OUT}}{\Delta I_{OUT}}$	Sourcing: 0 ≤ I _{OUT} ≤ 1mA		0.35	1.5	mV/mA	
		Sinking: 0 ≤ I _{OUT} ≤ 200μA		3.4	9.8		
OUT Short-Circuit Current	I _{SC}	Short to GND		13		mA	
		Short to IN		7			
Dropout Voltage	V _{IN} - V _{OUT}	I _{OUT} = 1mA (Note 5)		70	200	mV	
Temperature Hysteresis	$\frac{\Delta V_{OUT}}{\text{cycle}}$	(Note 3)		100		ppm	
Long-Term Stability	$\frac{\Delta V_{OUT}}{\text{time}}$	1000hr at T _A = +25°C		90		ppm/1000hr	
DYNAMIC							
Noise Voltage	e _{OUT}	f = 0.1Hz to 10Hz		90		μV _{P-P}	
		f = 10Hz to 10kHz		105		μV _{RMS}	
Ripple Rejection	$\frac{\Delta V_{OUT}}{\Delta V_{IN}}$	V _{IN} = 5V ±100mV, f = 120Hz		73		dB	
Turn-On Settling Time	t _R	To V _{OUT} = 0.1% of final value, C _{OUT} = 50pF		260		μs	
Capacitive-Load Stability Range	C _{OUT}	(Note 4)	0		1	μF	
INPUT							
Supply Voltage Range	V _{IN}	Guaranteed by line-regulation test		V _{OUT} + 0.2	5.5	V	
Quiescent Supply Current	I _{IN}			95	125	μA	
Change in Supply Current Per Change in Input Voltage	$\frac{\Delta I_{IN}}{\Delta V_{IN}}$	(V _{OUT} + 200mV) ≤ V _{IN} ≤ 5.5V		4.7	16	μA/V	

Note 1: All devices are 100% production tested at T_A = +25°C and are guaranteed by design for T_A = T_{MIN} to T_{MAX} as specified.

Note 2: Temperature coefficient is measured by the “box” method, i.e. the maximum ΔV_{OUT} / V_{OUT} is divided by the maximum ΔT.

Note 3: Temperature hysteresis is defined as the change in +25°C output voltage after cycling the device from T_{MIN} to T_{MAX}.

Note 4: Not production tested. Guaranteed by design.

Note 5: Dropout voltage is defined as the minimum differential voltage (V_{IN} - V_{OUT}) at which V_{OUT} decreases by 0.2% from its original value at V_{IN} = 5.0V (V_{IN} = 2.7V for MAX6034_25).

Precision, Micropower, Low-Dropout, SC70 Series Voltage Reference

Typical Operating Characteristics

($V_{IN} = 2.7V$ for MAX6034_21/25, $V_{IN} = 5V$ for MAX6034_30/33/41, $I_{OUT} = 0$, $T_A = +25^\circ C$, unless otherwise noted.) (Note 6)

MAX6034

MAX6034_21
OUTPUT VOLTAGE TEMPERATURE DRIFT
($V_{OUT} = 2.048V$)

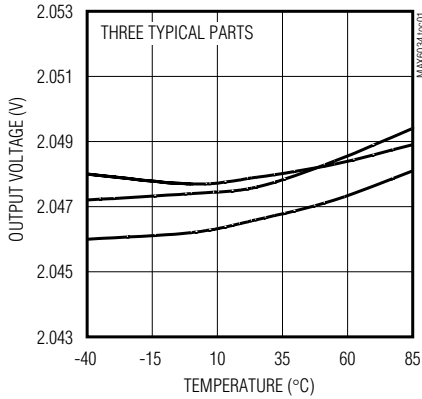

MAX6034_41
OUTPUT VOLTAGE TEMPERATURE DRIFT
($V_{OUT} = 4.096V$)

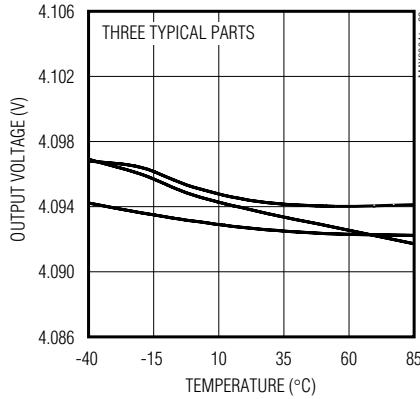

MAX6034_21
LONG-TERM DRIFT
($V_{OUT} = 2.048V$)

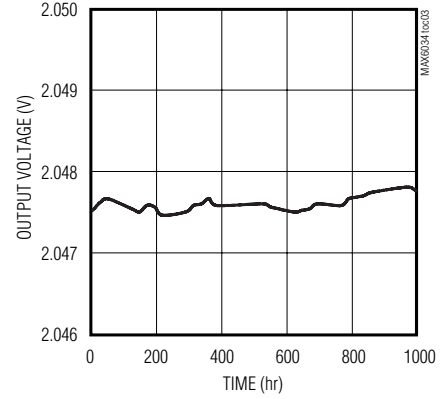

MAX6034_41
LONG-TERM DRIFT
($V_{OUT} = 4.096V$)

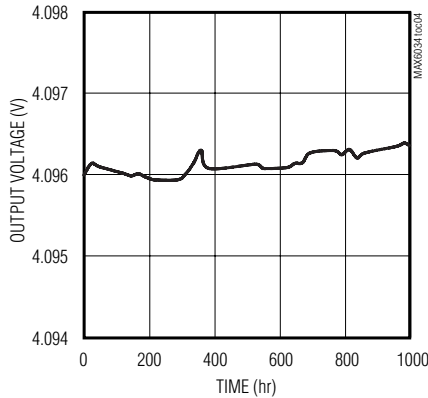

SUPPLY CURRENT vs. SUPPLY VOLTAGE

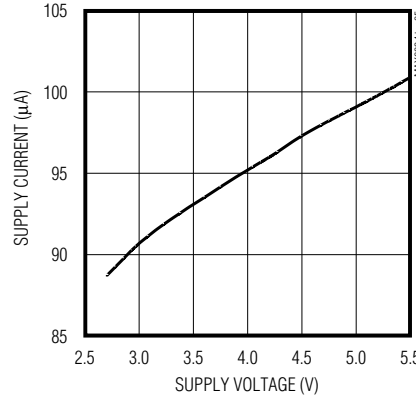

SUPPLY CURRENT vs. TEMPERATURE

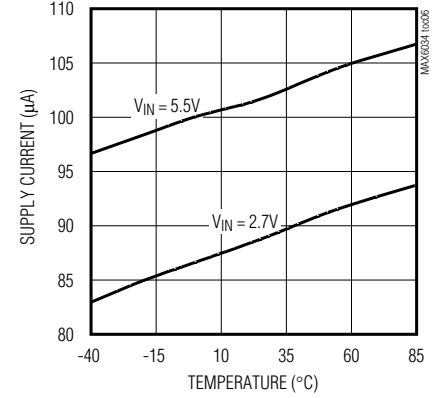

MAX6034_25
DROPOUT VOLTAGE vs. SOURCE CURRENT
($V_{OUT} = 2.500V$)

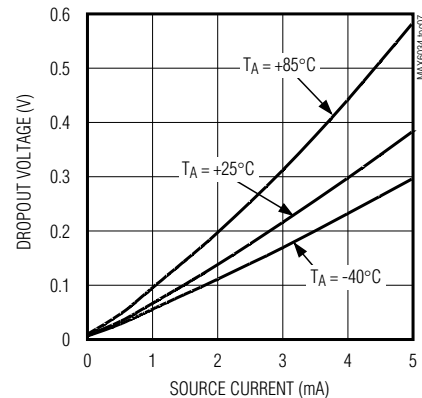

MAX6034_25
DROPOUT VOLTAGE vs. SINK CURRENT
($V_{OUT} = 2.500V$)

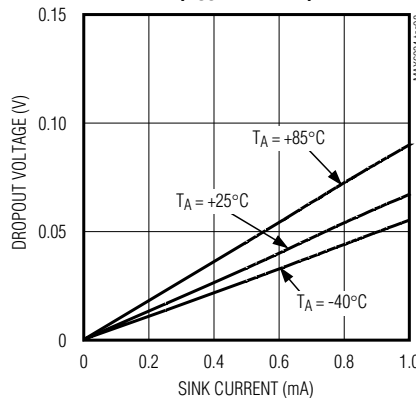

MAX6034_41
DROPOUT VOLTAGE vs. SOURCE CURRENT
($V_{OUT} = 4.096V$)

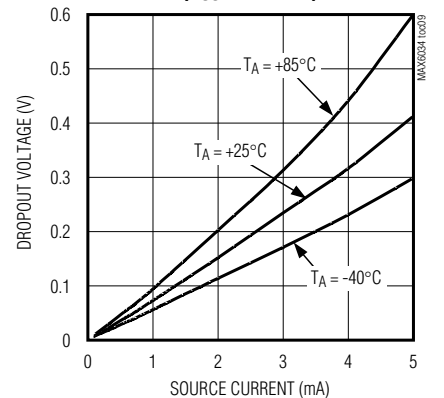

Precision, Micropower, Low-Dropout, SC70 Series Voltage Reference

Typical Operating Characteristics (continued)

($V_{IN} = 2.7V$ for MAX6034_21/25, $V_{IN} = 5V$ for MAX6034_30/33/41, $I_{OUT} = 0$, $T_A = +25^\circ C$, unless otherwise noted.) (Note 6)

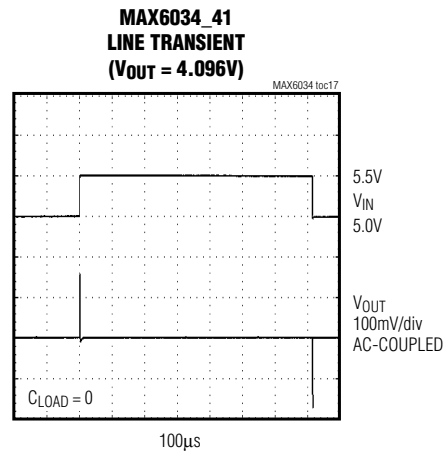
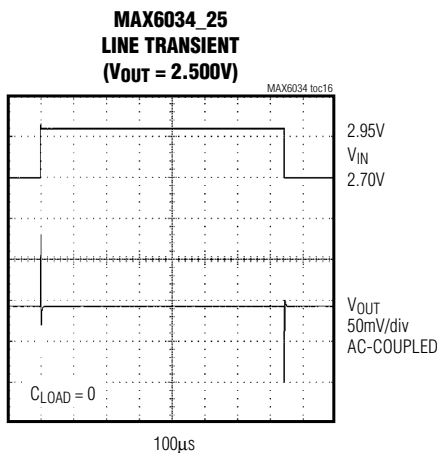
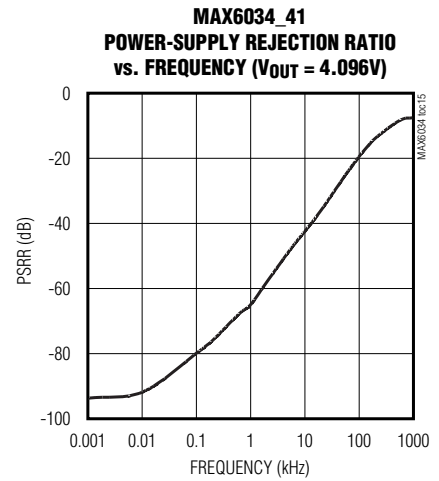
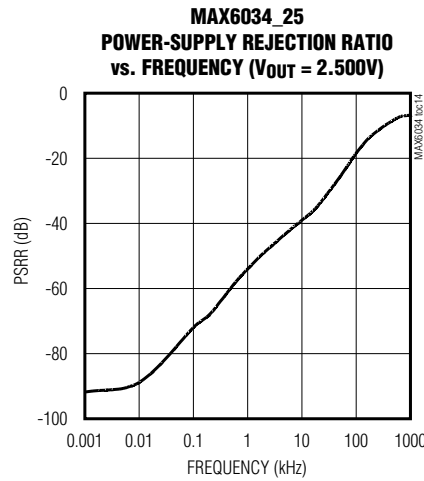
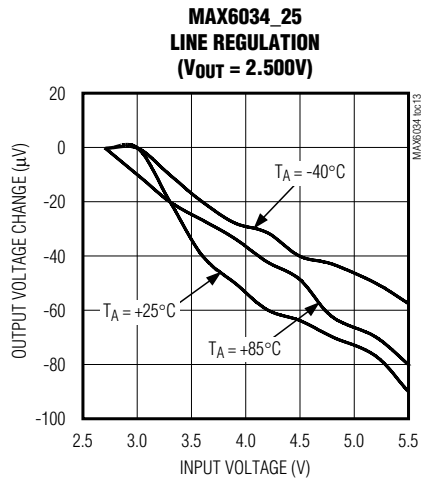
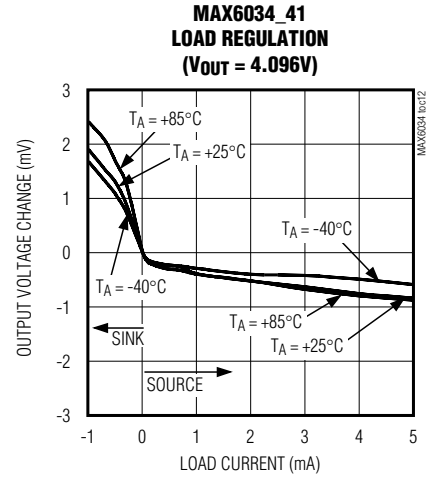
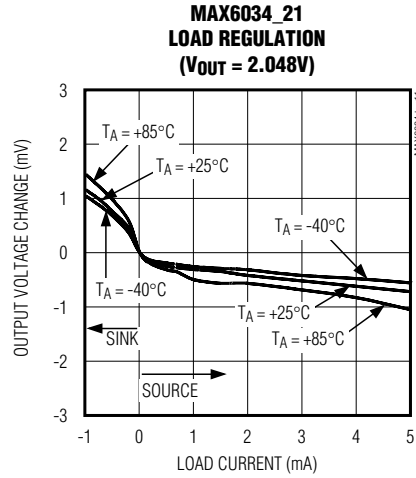
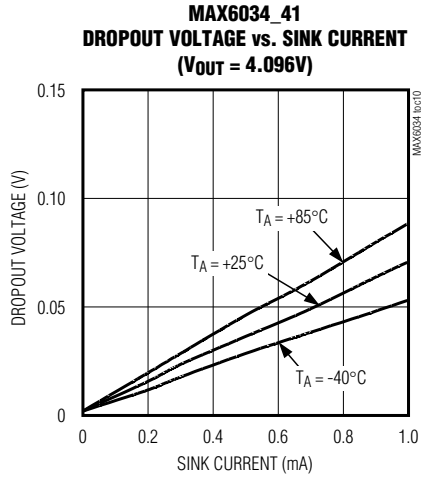

Precision, Micropower, Low-Dropout, SC70 Series Voltage Reference

MAX6034

Typical Operating Characteristics (continued)

($V_{IN} = 2.7V$ for MAX6034_21/25, $V_{IN} = 5V$ for MAX6034_30/33/41, $I_{OUT} = 0$, $T_A = +25^\circ C$, unless otherwise noted.) (Note 6)

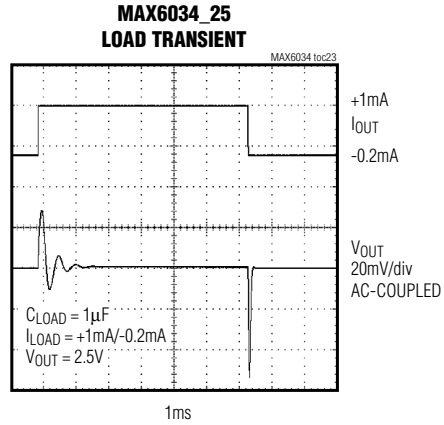
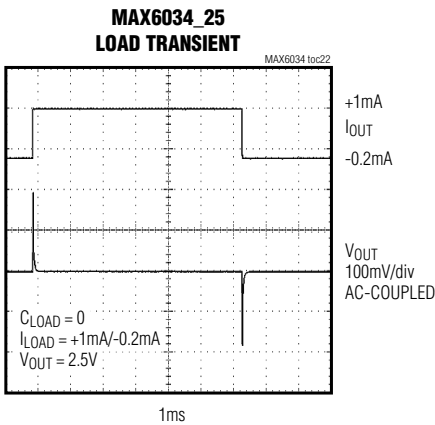
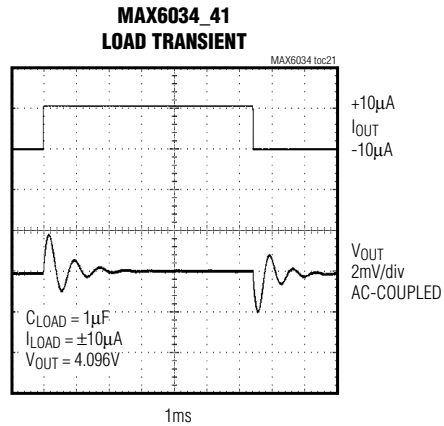
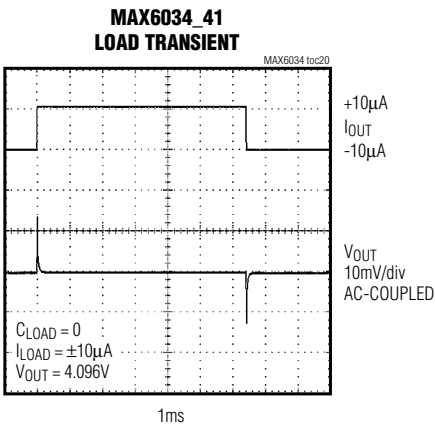
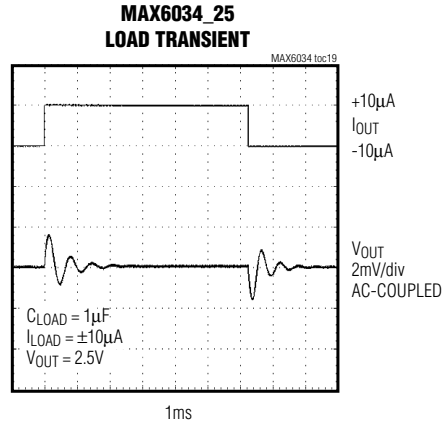
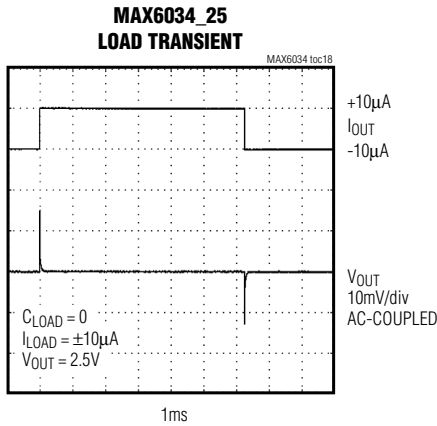

Precision, Micropower, Low-Dropout, SC70 Series Voltage Reference

Typical Operating Characteristics (continued)

($V_{IN} = 2.7V$ for MAX6034_21/25, $V_{IN} = 5V$ for MAX6034_30/33/41, $I_{OUT} = 0$, $T_A = +25^\circ C$, unless otherwise noted.) (Note 6)

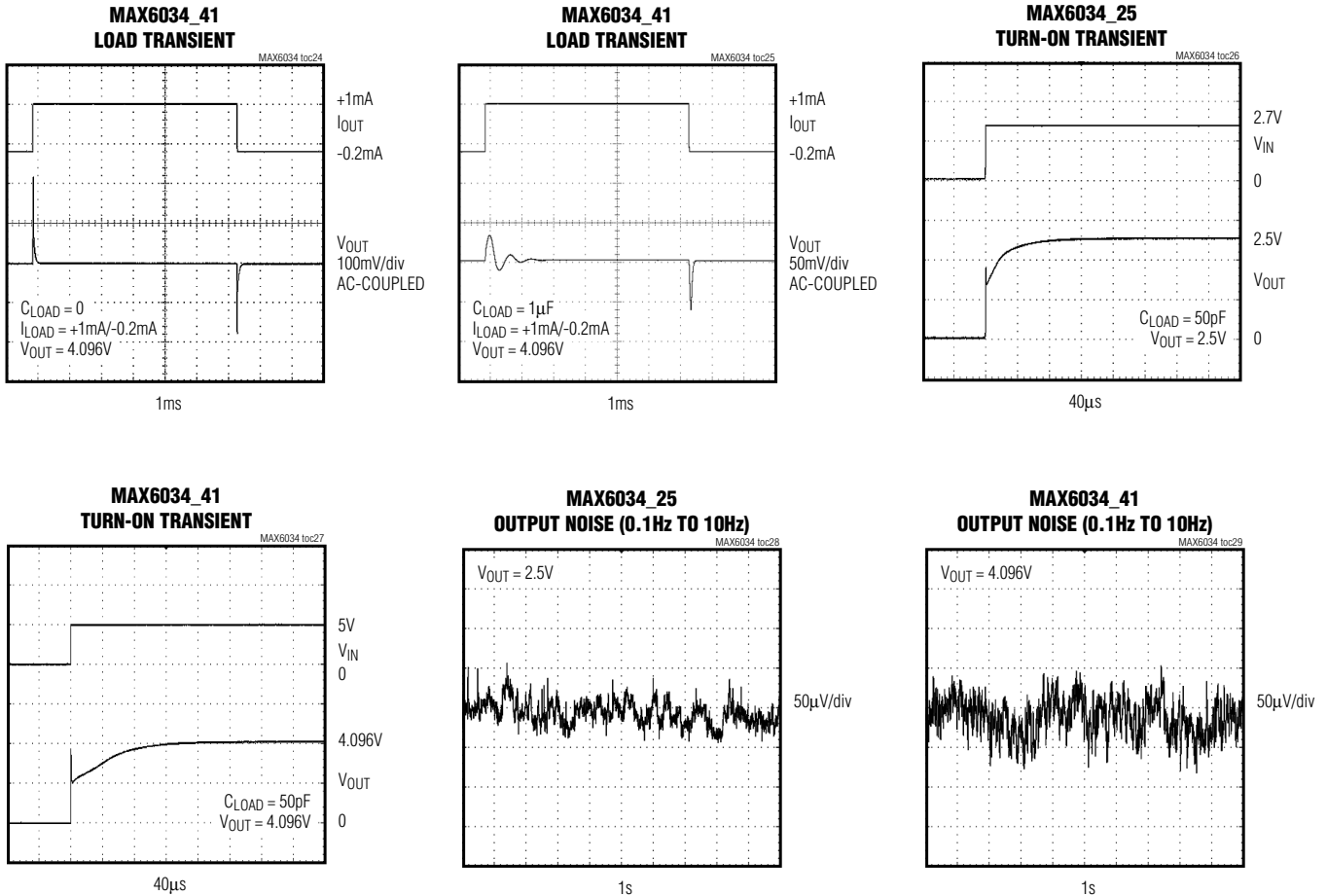

Note 6: Many of the MAX6034 family *Typical Operating Characteristics* are extremely similar. The extremes of these characteristics are found in the MAX6034_21 (2.048V output) and the MAX6034_41 (4.096V output). The *Typical Operating Characteristics* of the remainder of the MAX6034 family typically lie between those two extremes and can be estimated based on their output voltages.

Precision, Micropower, Low-Dropout, SC70 Series Voltage Reference

MAX6034

Pin Description

PIN	NAME	FUNCTION
1	IN	Supply Voltage Input
2	OUT	Reference Voltage Output
3	GND	Ground

Detailed Description

The MAX6034 family of precision bandgap references use a proprietary temperature coefficient curvature-correction circuit and laser-trimmed, thin-film resistors, resulting in a low temperature coefficient of less than 30ppm/°C and initial accuracy of better than 0.2%. These devices can source up to 1mA and sink up to 200µA with less than 200mV of dropout voltage, making them attractive for use in low-voltage applications.

Applications Information

Input Bypassing

For the best line-transient performance, decouple the input with a 0.1µF ceramic capacitor as shown in the *Typical Operating Circuit*. Locate the capacitor as close to IN as possible.

Output/Load Capacitance

Devices in the MAX6034 family do not require an output capacitor for frequency stability. They are stable for capacitive loads from 0 to 1µF. However, in applications where the load or the supply can experience step changes, an output capacitor reduces the amount of overshoot (or undershoot) and improves the circuit's transient response. Many applications do not need an external capacitor, and the MAX6034 can offer a significant advantage in these applications when board space is critical.

Supply Current

The quiescent supply current of the series-mode MAX6034 family is typically 90µA and is virtually independent of the supply voltage, with only a 16µA/V (max) variation with supply voltage.

When the supply voltage is below the minimum-specified input voltage (as during turn-on), the device can draw up to 50µA beyond the nominal supply current. The input-voltage source must be capable of providing this current to ensure reliable turn-on.

Output Voltage Hysteresis

Output voltage hysteresis is the change in the output voltage at $T_A = +25^\circ\text{C}$ before and after the device is cycled over its entire operating temperature range. Hysteresis is caused by differential package stress appearing across the bandgap core transistors. The typical temperature hysteresis value for the MAX6034 family is 100ppm.

Turn-On Time

These devices typically turn on and settle to within 0.1% of their final value in 85µs to 260µs depending on the device. The turn-on time can increase up to 1.25ms with the device operating at the minimum dropout voltage and the maximum load.

Temperature Coefficient vs. Operating Temperature Range for a 1LSB Maximum Error

In a data converter application, the reference voltage of the converter must stay within a certain limit to keep the error in the data converter smaller than the resolution limit through the operating temperature range. Figure 1 shows the maximum allowable reference voltage temperature coefficient to keep the conversion error to less than 1LSB, as a function of the operating temperature range ($T_{MAX} - T_{MIN}$) with the converter resolution as a parameter. The graph assumes the reference-voltage temperature coefficient as the only parameter affecting accuracy.

In reality, the absolute static accuracy of a data converter is dependent on the combination of many parameters such as integral nonlinearity, differential nonlinearity, offset error, gain error, as well as voltage reference changes.

Precision, Micropower, Low-Dropout, SC70 Series Voltage Reference

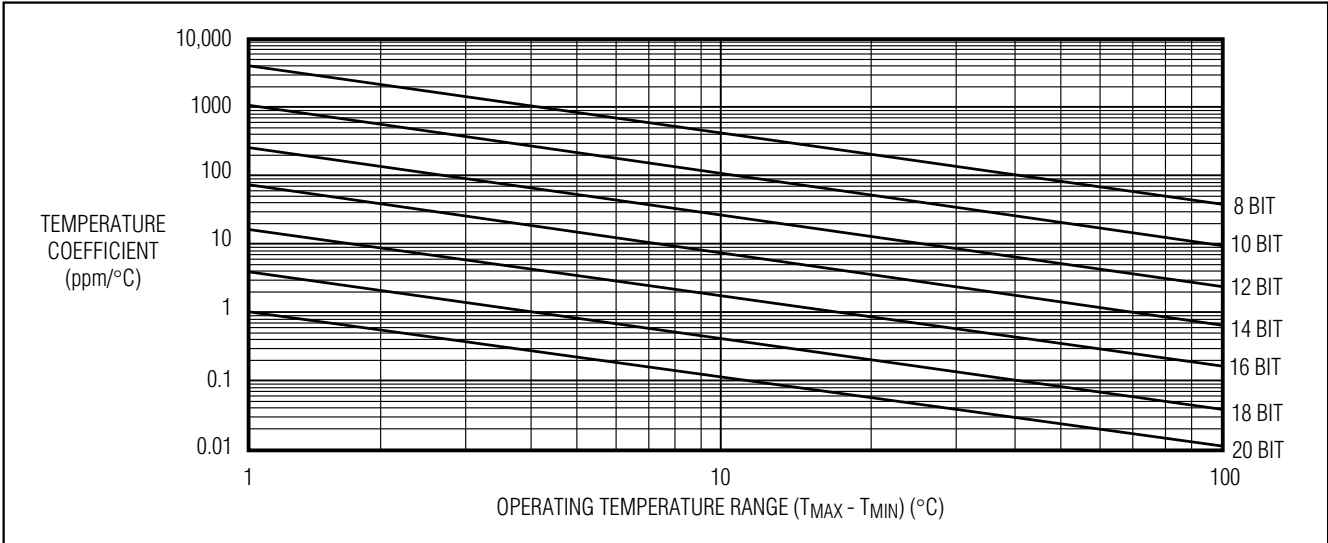

Figure 1. Temperature Coefficient vs. Operating Temperature Range for a 1LSB Maximum Error

Chip Information

TRANSISTOR COUNT: 113

PROCESS: BiCMOS

Precision, Micropower, Low-Dropout, SC70 Series Voltage Reference

Package Information

MAX6034

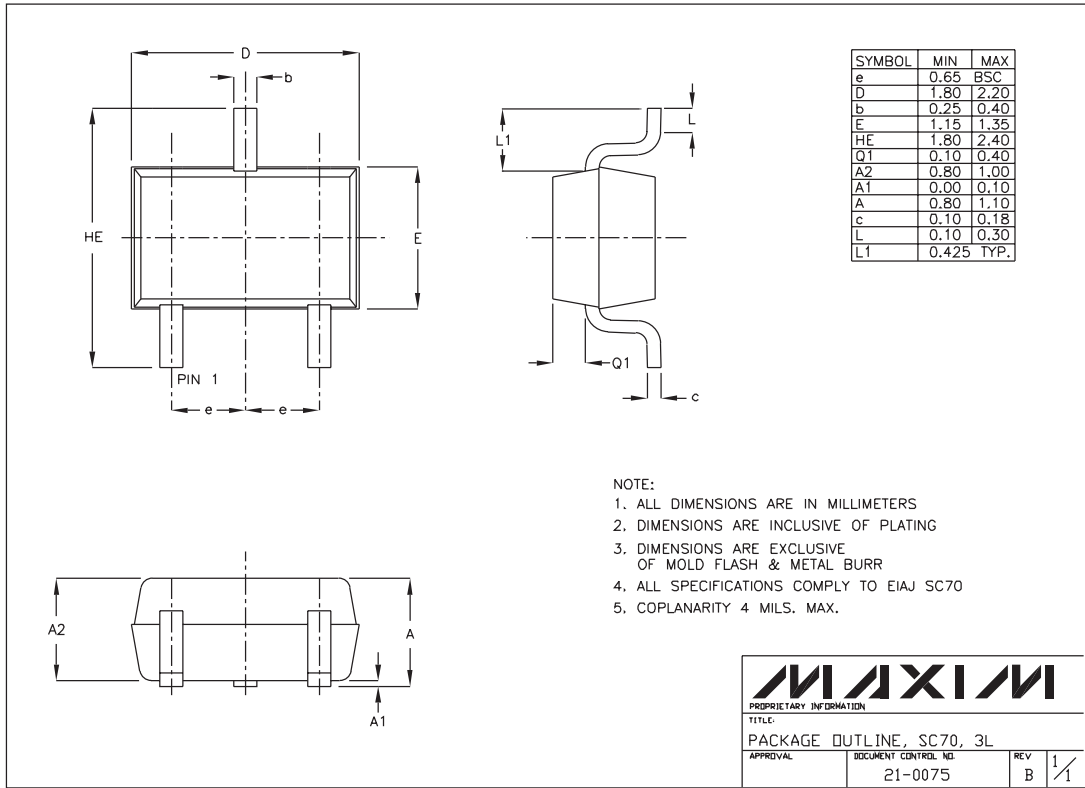

SC70, 3LEPS

Maxim cannot assume responsibility for use of any circuitry other than circuitry entirely embodied in a Maxim product. No circuit patent licenses are implied. Maxim reserves the right to change the circuitry and specifications without notice at any time.

Maxim Integrated Products, 120 San Gabriel Drive, Sunnyvale, CA 94086 408-737-7600 _____ 13

Looking for pricing, stock, or lifecycle information?

Click below to explore more details on WIN SOURCE:

- ⊖ [View MAX6034AEXR30+T on WIN SOURCE](#)
- ⊖ [Maxim Integrated Information](#)

Optimize Your Supply Chain with WIN SOURCE Solutions

- ✓ Global Sourcing Solution
- ✓ Obsolete Management
- ✓ Cost Control Management
- ✓ Shortage Management
- ✓ Alternative Solution
- ✓ Excess Inventory Management