



**THE DATASHEET OF
MAX5441ACUA+**





+3V/+5V, Serial-Input, Voltage-Output, 16-Bit DACs

MAX5441-MAX5444

General Description

The MAX5441-MAX5444 are serial-input, voltage-output, 16-bit digital-to-analog converters (DACs) in tiny μ MAX[®] packages, 50% smaller than comparable DACs in 8-pin SOs. They operate from low +3V (MAX5443/MAX5444) or +5V (MAX5441/MAX5442) single supplies. They provide 16-bit performance (± 2 LSB INL and ± 1 LSB DNL) over temperature without any adjustments. Unbuffered DAC outputs result in a low supply current of 120 μ A and a low offset error of 2LSB.

The DAC output ranges from 0 to V_{REF} . For bipolar operation, matched scaling resistors are provided in the MAX5442/MAX5444 for use with an external precision op amp (such as the MAX400), generating a $\pm V_{REF}$ output swing.

A 16-bit serial word is used to load data into the DAC latch. The 25MHz, 3-wire serial interface is compatible with SPI/QSPI[™]/MICROWIRE, and can interface directly with optocouplers for applications requiring isolation. A power-on reset circuit clears the DAC output to code 0 (MAX5441/MAX5443) or code 32768 (MAX5442/MAX5444) when power is initially applied.

A logic low on \overline{CLR} asynchronously clears the DAC output to code 0 (MAX5441/MAX5443) or code 32768 (MAX5442/MAX5444) independent of the serial interface.

The MAX5441/MAX5443 are available in 8-pin μ MAX packages. The MAX5442/MAX5444 are available in 10-pin μ MAX packages.

Applications

High-Resolution Offset and Gain Adjustment
Industrial Process Control
Automated Test Equipment
Data-Acquisition Systems

Features

- ◆ Ultra-Small 3mm x 5mm 8-Pin μ MAX Package
- ◆ Low 120 μ A Supply Current
- ◆ Fast 1 μ s Settling Time
- ◆ 25MHz SPI/QSPI/MICROWIRE-Compatible Serial Interface
- ◆ V_{REF} Range Extends to V_{DD}
- ◆ +5V (MAX5441/MAX5442) or +3V (MAX5443/MAX5444) Single-Supply Operation
- ◆ Full 16-Bit Performance Without Adjustments
- ◆ Unbuffered Voltage Output Directly Drives 60k Ω Loads
- ◆ Power-On Reset Circuit Clears DAC Output to Code 0 (MAX5441/MAX5443) or Code 32768 (MAX5442/MAX5444)
- ◆ Schmitt-Trigger Inputs for Direct Optocoupler Interface
- ◆ Asynchronous \overline{CLR}

Pin Configurations

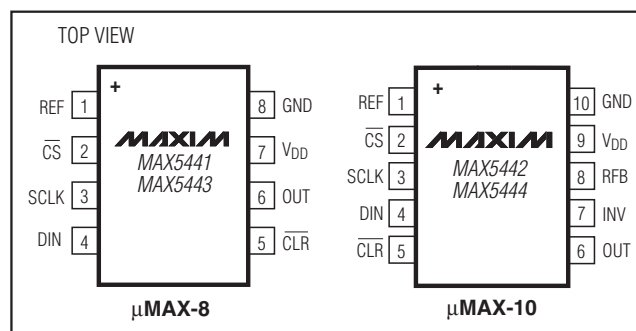

Functional Diagrams appear at end of data sheet.

Ordering Information

PART	TEMP RANGE	PIN-PACKAGE	INL (LSB)	SUPPLY (V)
MAX5441 ACUA+	0°C to +70°C	8 μ MAX	± 2	5
MAX5441AEUA+	-40°C to +85°C	8 μ MAX	± 2	5
MAX5441BCUA+	0°C to +70°C	8 μ MAX	± 4	5
MAX5441BEUA+	-40°C to +85°C	8 μ MAX	± 4	5
MAX5442 ACUB+	0°C to +70°C	10 μ MAX	± 2	5
MAX5442AEUB+	-40°C to +85°C	10 μ MAX	± 2	5
MAX5442BCUB+	0°C to +70°C	10 μ MAX	± 4	5
MAX5442BEUB+	-40°C to +85°C	10 μ MAX	± 4	5

μ MAX is a registered trademark of Maxim Integrated Products, Inc.
QSPI is a trademark of Motorola, Inc.
MICROWIRE is a registered trademark of National Semiconductor Corp.

+Denotes a lead(Pb)-free/RoHS-compliant package.

Note: For leaded version, contact factory.

Ordering Information continued at end of data sheet.



+3V/+5V, Serial-Input, Voltage-Output, 16-Bit DACs

ABSOLUTE MAXIMUM RATINGS

V _{DD} to GND	-0.3V to +6V
CS, SCLK, DIN, CLR to GND	-0.3V to +6V
REF to GND	-0.3V to (V _{DD} + 0.3V)
OUT, INV to GND	-0.3V to V _{DD}
RFB to INV	-6V to +6V
RFB to GND	-6V to +6V
Maximum Current Into Any Pin	50mA

Continuous Power Dissipation (T _A = +70°C)	
8-Pin μMAX (derate 4.5mW/°C above +70°C)	362mW
10-Pin μMAX (derate 5.6mW/°C above +70°C)	444mW
Operating Temperature Ranges	
MAX544 __CU_	0°C to +70°C
MAX544 __EU_	-40°C to +85°C
Storage Temperature Range	-65°C to +150°C
Maximum Die Temperature	+150°C
Lead Temperature (soldering, 10s)	+300°C

Stresses beyond those listed under "Absolute Maximum Ratings" may cause permanent damage to the device. These are stress ratings only, and functional operation of the device at these or any other conditions beyond those indicated in the operational sections of the specifications is not implied. Exposure to absolute maximum rating conditions for extended periods may affect device reliability.

ELECTRICAL CHARACTERISTICS

(V_{DD} = +3V (MAX5443/MAX5444) or +5V (MAX5441/MAX5442), V_{REF} = +2.5V, C_L = 10pF, GND = 0, R_L = ∞, T_A = T_{MIN} to T_{MAX}, unless otherwise noted. Typical values are at T_A = +25°C.)

PARAMETER	SYMBOL	CONDITIONS	MIN	TYP	MAX	UNITS
STATIC PERFORMANCE—ANALOG SECTION						
Resolution	N		16			Bits
Differential Nonlinearity	DNL	Guaranteed monotonic		±0.5	±1	LSB
Integral Nonlinearity	INL	MAX544_A		±0.5	±2	LSB
		MAX544_B		±0.5	±4	
Zero-Code Offset Error	ZSE				±2	LSB
Zero-Code Tempco	ZSTC			±0.05		ppm/°C
Gain Error (Note 1)					±10	LSB
Gain-Error Tempco				±0.1		ppm/°C
DAC Output Resistance	R _{OUT}	(Note 2)		6.2		kΩ
Bipolar Resistor Matching		R _{FBI} /R _{INV}		1		%
		Ratio error			±0.015	
Bipolar Zero Offset Error					±20	LSB
Bipolar Zero Tempco	BZSTC			±0.5		ppm/°C
Power-Supply Rejection	PSR	+2.7V ≤ V _{DD} ≤ +3.3V (MAX5443/MAX5444)			±1	LSB
		+4.5V ≤ V _{DD} ≤ +5.5V (MAX5441/MAX5442)			±1	
REFERENCE INPUT						
Reference Input Range	V _{REF}	(Note 3)	2.0		V _{DD}	V
Reference Input Resistance (Note 4)	R _{REF}	Unipolar mode	10			kΩ
		Bipolar mode	6			
DYNAMIC PERFORMANCE—ANALOG SECTION						
Voltage-Output Slew Rate	SR	(Note 5)		15		V/μs
Output Settling Time		To ±½LSB of FS		1		μs
DAC Glitch Impulse		Major-carry transition		7		nV-s
Digital Feedthrough		Code = 0000 hex; CS = V _{DD} ; SCLK, DIN = 0 to V _{DD} levels		0.2		nV-s

+3V/+5V, Serial-Input, Voltage-Output, 16-Bit DACs

MAX5441-MAX5444

ELECTRICAL CHARACTERISTICS (continued)

($V_{DD} = +3V$ (MAX5443/MAX5444) or $+5V$ (MAX5441/MAX5442), $V_{REF} = +2.5V$, $C_L = 10pF$, $GND = 0$, $R_L = \infty$, $T_A = T_{MIN}$ to T_{MAX} , unless otherwise noted. Typical values are at $T_A = +25^\circ C$.)

PARAMETER	SYMBOL	CONDITIONS	MIN	TYP	MAX	UNITS
DYNAMIC PERFORMANCE—REFERENCE SECTION						
Reference -3dB Bandwidth	BW	Code = FFFF hex		1		MHz
Reference Feedthrough		Code = 0000 hex, $V_{REF} = 1V_{P-P}$ at 100kHz		1		mV _{P-P}
Signal-to-Noise Ratio	SNR			92		dB
Reference Input Capacitance	C_{INREF}	Code = 0000 hex		70		pF
		Code = FFFF hex		170		
STATIC PERFORMANCE—DIGITAL INPUTS						
Input High Voltage	V_{IH}		2.4			V
Input Low Voltage	V_{IL}				0.8	V
Input Current	I_{IN}				± 1	μA
Input Capacitance	C_{IN}	(Note 6)		3	10	pF
Hysteresis Voltage	V_H			0.15		V
POWER SUPPLY						
Positive Supply Range (Note 7)	V_{DD}	MAX5443/MAX5444	2.7		3.6	V
		MAX5441/MAX5442	4.5		5.5	
Positive Supply Current	I_{DD}	All digital inputs at V_{DD} or GND		0.12	0.20	mA
Power Dissipation	PD	All digital inputs at V_{DD} or GND		0.36		mW
				0.60		

TIMING CHARACTERISTICS

($V_{DD} = +2.7V$ to $+3.3V$ (MAX5443/MAX5444), $V_{DD} = +4.5V$ to $+5.5V$ (MAX5441/MAX5442), $V_{REF} = +2.5V$, $GND = 0$, CMOS inputs, $T_A = T_{MIN}$ to T_{MAX} , unless otherwise noted. Typical values are at $T_A = +25^\circ C$.) (Figure 1)

PARAMETER	SYMBOL	CONDITIONS	MIN	TYP	MAX	UNITS
SCLK Frequency	f_{CLK}				25	MHz
SCLK Pulse Width High	t_{CH}		20			ns
SCLK Pulse Width Low	t_{CL}		20			ns
\overline{CS} Low to SCLK High Setup	t_{CSS0}		15			ns
\overline{CS} High to SCLK High Setup	t_{CSS1}		15			ns
SCLK High to \overline{CS} Low Hold	t_{CSH0}	(Note 6)	35			ns
SCLK High to \overline{CS} High Hold	t_{CSH1}		20			ns
DIN to SCLK High Setup	t_{DS}		15			ns
DIN to SCLK High Hold	t_{DH}		0			ns
\overline{CLR} Pulse Width Low	t_{CLW}		20			ns
V_{DD} High to \overline{CS} Low (power-up delay)				20		μs

Note 1: Gain error tested at $V_{REF} = +2.0V$, $+2.5V$, and $+3.0V$ (MAX5443/MAX5444) or $V_{REF} = +2.0V$, $+2.5V$, $+3.0V$, and $+5.5V$ (MAX5441/ MAX5442).

Note 2: RO_{UT} tolerance is typically $\pm 20\%$.

Note 3: Min/max range guaranteed by gain-error test. Operation outside min/max limits will result in degraded performance.

Note 4: Reference input resistance is code-dependent, minimum at 8555hex in unipolar mode, 4555hex in bipolar mode.

Note 5: Slew-rate value is measured from 10% to 90%.

Note 6: Guaranteed by design. Not production tested.

Note 7: Guaranteed by power-supply rejection test and *Timing Characteristics*.

+3V/+5V, Serial-Input, Voltage-Output, 16-Bit DACs

Typical Operating Characteristics

($V_{DD} = +3V$ (MAX5443/MAX5444) or $+5V$ (MAX5441/MAX5442), $V_{REF} = +2.5V$, $GND = 0$, $R_L = \infty$, $T_A = T_{MIN}$ to T_{MAX} , unless otherwise noted. Typical values are at $T_A = +25^\circ C$.)

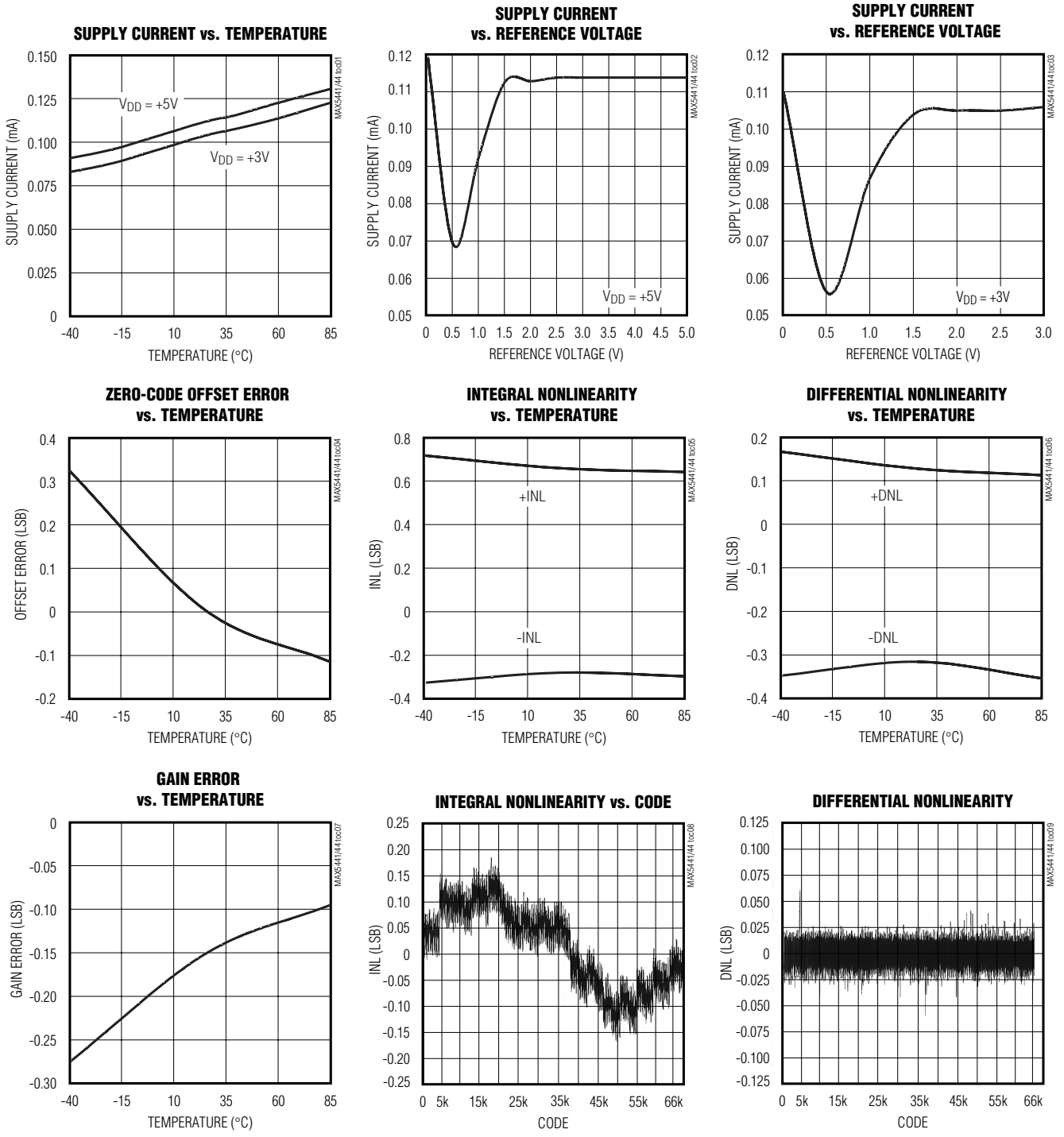

+3V/+5V, Serial-Input, Voltage-Output, 16-Bit DACs

MAX5441-MAX5444

Typical Operating Characteristics (continued)

($V_{DD} = +3V$ (MAX5443/MAX5444) or $+5V$ (MAX5441/MAX5442), $V_{REF} = +2.5V$, $GND = 0$, $R_L = \infty$, $T_A = T_{MIN}$ to T_{MAX} , unless otherwise noted. Typical values are at $T_A = +25^\circ C$.)

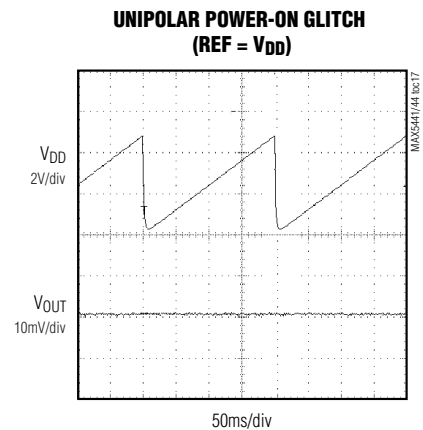
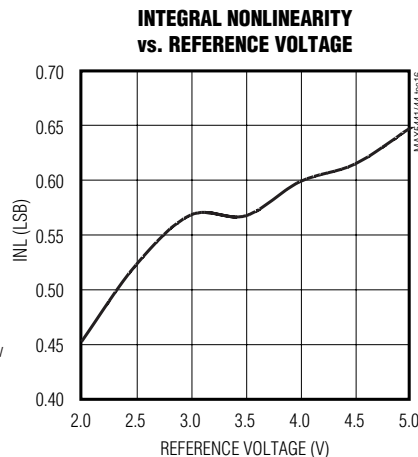
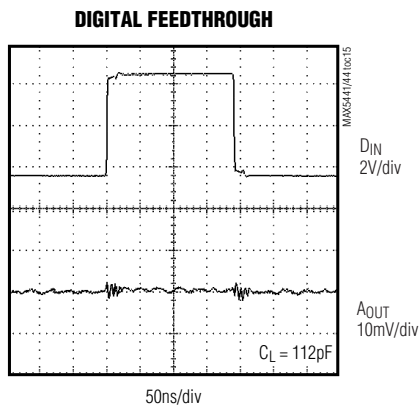
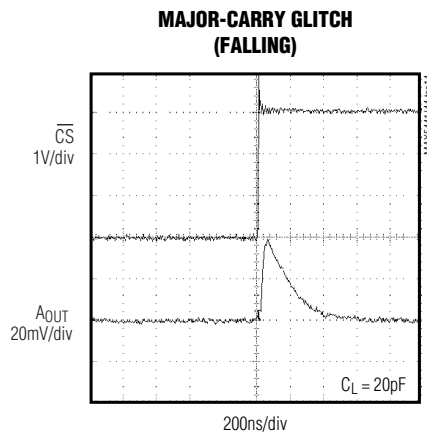
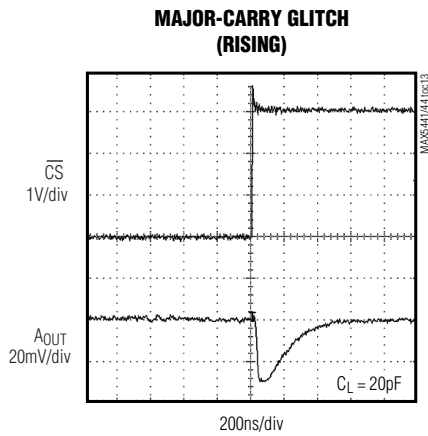
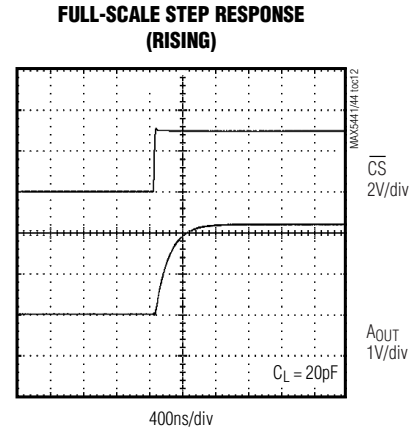
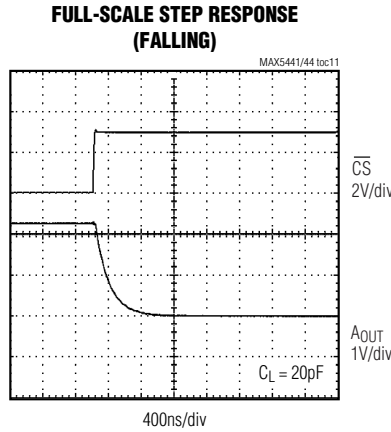
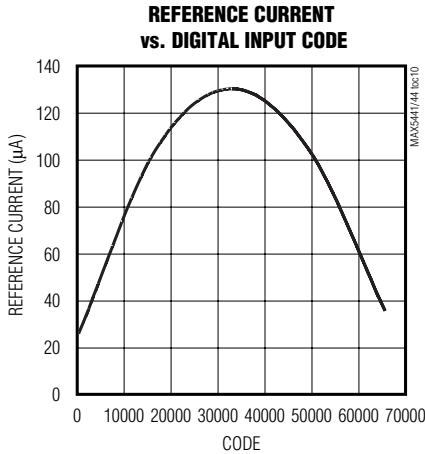

+3V/+5V, Serial-Input, Voltage-Output, 16-Bit DACs

Pin Description

PIN		NAME	FUNCTION
MAX5441 MAX5443	MAX5442 MAX5444		
1	1	REF	Voltage Reference Input
2	2	\overline{CS}	Chip-Select Input
3	3	SCLK	Serial Clock Input. Duty cycle must be between 40% and 60%.
4	4	DIN	Serial Data Input
5	5	\overline{CLR}	Clear Input. Logic low asynchronously clears the DAC to code 0 (MAX5441/MAX5443) or code 32768 (MAX5442/MAX5444).
6	6	OUT	DAC Output Voltage
—	7	INV	Junction of Internal Scaling Resistors. Connect to external op amp's inverting input in bipolar mode.
—	8	RFB	Feedback Resistor. Connect to external op amp's output in bipolar mode.
7	9	V _{DD}	Supply Voltage. Use +3V for MAX5443/MAX5444 and +5V for MAX5441/MAX5442.
8	10	GND	Ground

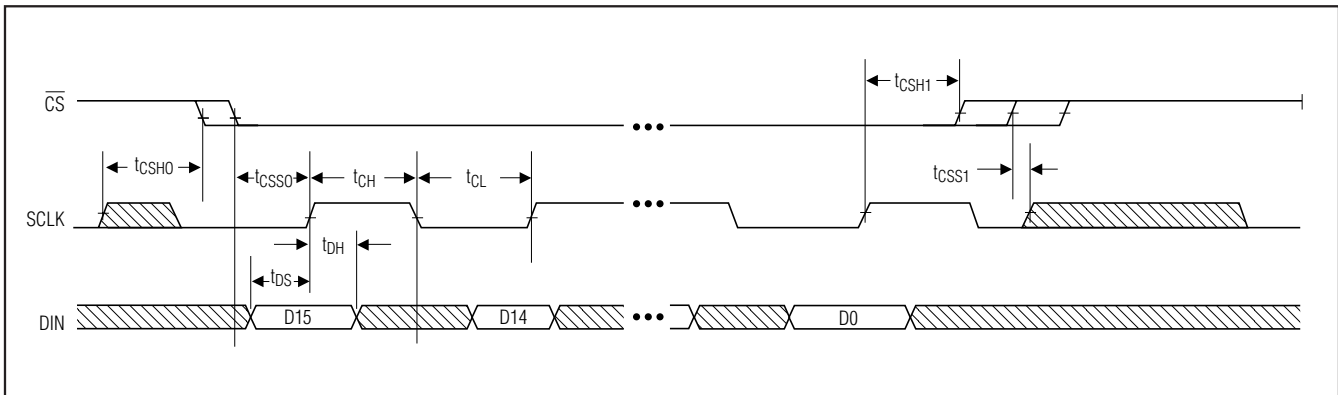

Figure 1. Timing Diagram

+3V/+5V, Serial-Input, Voltage-Output, 16-Bit DACs

MAX5441-MAX5444

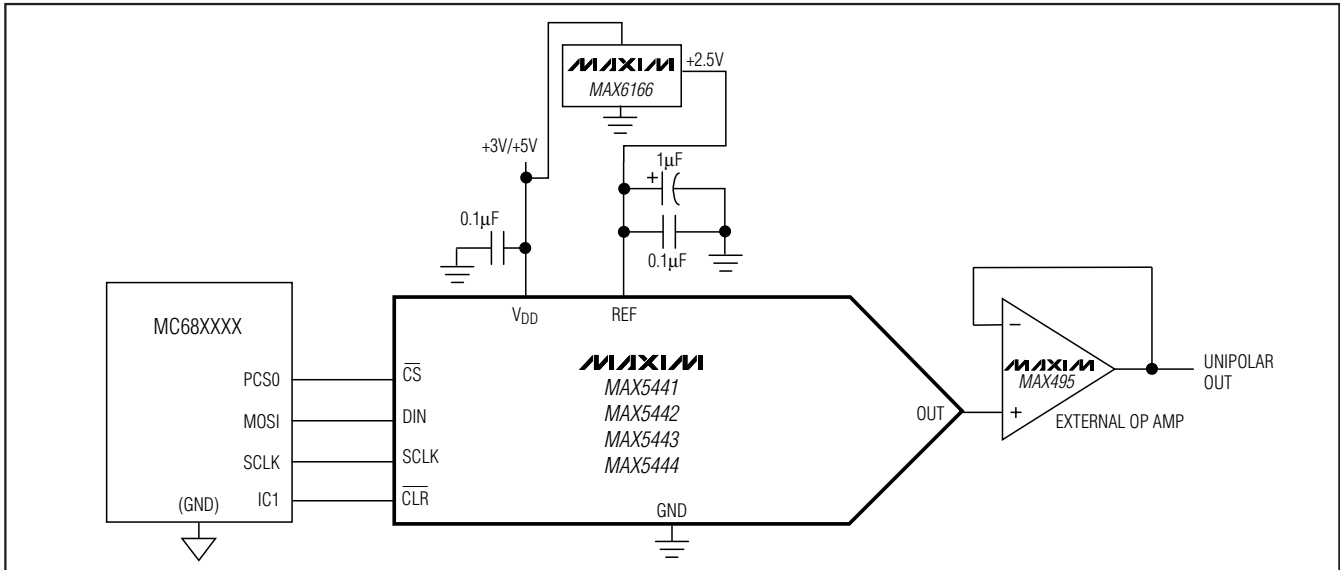

Figure 2a. Typical Operating Circuit—Unipolar Output

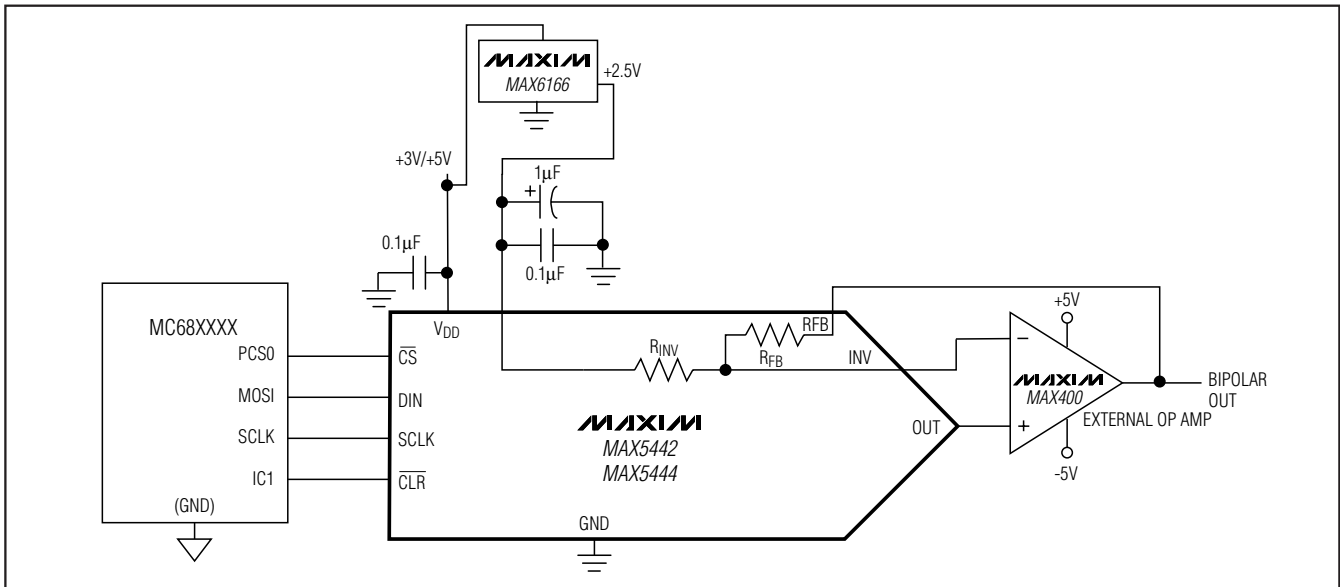

Figure 2b. Typical Operating Circuit—Bipolar Output

Detailed Description

The MAX5441–MAX5444 voltage-output, 16-bit digital-to-analog converters (DACs) offer full 16-bit performance with less than 2LSB integral linearity error and less than 1LSB differential linearity error, thus ensuring monotonic performance. Serial data transfer minimizes the number of package pins required.

The MAX5441–MAX5444 are composed of two matched DAC sections, with a 12-bit inverted R-2R DAC forming the 12 LSBs and the four MSBs derived from 15 identically matched resistors. This architecture allows the lowest glitch energy to be transferred to the DAC output on major-carry transitions. It also lowers the DAC output impedance by a factor of eight compared

+3V/+5V, Serial-Input, Voltage-Output, 16-Bit DACs

to a standard R-2R ladder, allowing unbuffered operation in medium-load applications.

The MAX5442/MAX5444 provide matched bipolar offset resistors, which connect to an external op amp for bipolar output swings (Figure 2b).

Digital Interface

The MAX5441-MAX5444 digital interface is a standard 3-wire connection compatible with SPI/QSPI/MICROWIRE interfaces. The chip-select input (\overline{CS}) frames the serial data loading at the data-input pin (DIN). Immediately following \overline{CS} 's high-to-low transition, the data is shifted synchronously and latched into the input register on the rising edge of the serial clock input (SCLK). After 16 data bits have been loaded into the serial input register, it transfers its contents to the DAC latch on \overline{CS} 's low-to-high transition (Figure 3). Note that if \overline{CS} is not kept low during the entire 16 SCLK cycles, data will be corrupted. In this case, reload the DAC latch with a new 16-bit word.

Clearing the DAC

A 20ns (min) logic-low pulse on CLR asynchronously clears the DAC buffer to code 0 in the MAX5441/MAX5443 and to code 32768 in the MAX5442/MAX5444.

External Reference

The MAX5441-MAX5444 operate with external voltage references from 2V to V_{DD} . The reference voltage determines the DAC's full-scale output voltage.

Power-On Reset

The power-on reset circuit sets the output of the MAX5441/MAX5443 to code 0 and the output of the

MAX5442/MAX5444 to code 32768 when V_{DD} is first applied. This ensures that unwanted DAC output voltages will not occur immediately following a system power-up, such as after a loss of power.

Applications Information

Reference and Ground Inputs

The MAX5441-MAX5444 operate with external voltage references from 2V to V_{DD} , and maintain 16-bit performance if certain guidelines are followed when selecting and applying the reference. Ideally, the reference's temperature coefficient should be less than 0.1ppm/ $^{\circ}C$ to maintain 16-bit accuracy to within 1LSB over the $-40^{\circ}C$ to $+85^{\circ}C$ extended temperature range. Since this converter is designed as an inverted R-2R voltage-mode DAC, the input resistance seen by the voltage reference is code-dependent. In unipolar mode, the worst-case input-resistance variation is from 11.5k Ω (at code 8555hex) to 200k Ω (at code 0000hex). The maximum change in load current for a 2.5V reference is $2.5V / 11.5k\Omega = 217\mu A$; therefore, the required load regulation is 7ppm/mA for a maximum error of 0.1LSB. This implies a reference output impedance of less than 18m Ω . In addition, the impedance of the signal path from the voltage reference to the reference input must be kept low because it contributes directly to the load-regulation error.

The requirement for a low-impedance voltage reference is met with capacitor bypassing at the reference inputs and ground. A 0.1 μF ceramic capacitor with short leads between REF and GND provides high-frequency bypassing. A surface-mount ceramic chip capacitor is preferred because it has the lowest inductance. An

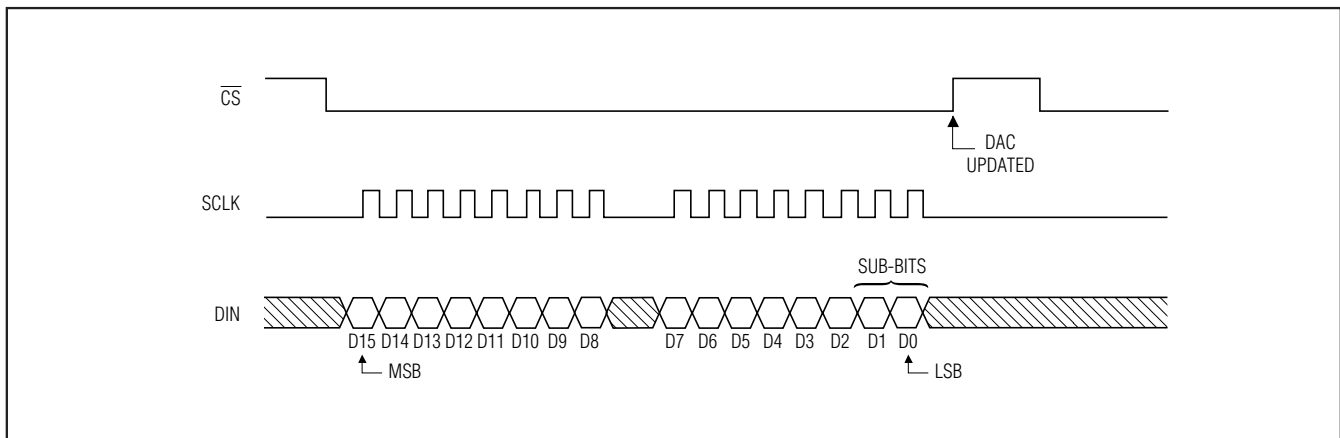

Figure 3. MAX5441-MAX5444 3-Wire Interface Timing Diagram

+3V/+5V, Serial-Input, Voltage-Output, 16-Bit DACs

additional 1 μ F between REF and GND provides low-frequency bypassing. A low-ESR tantalum, film, or organic semiconductor capacitor works well. Leaded capacitors are acceptable because impedance is not as critical at lower frequencies. The circuit can benefit from even larger bypassing capacitors, depending on the stability of the external reference with capacitive loading.

Unbuffered Operation

Unbuffered operation reduces power consumption as well as offset error contributed by the external output buffer. The R-2R DAC output is available directly at OUT, allowing 16-bit performance from +VREF to GND without degradation at zero-scale. The DAC's output impedance is also low enough to drive medium loads ($R_L > 60k\Omega$) without degradation of INL or DNL; only the gain error is increased by externally loading the DAC output.

External Output Buffer Amplifier

The requirements on the external output buffer amplifier change whether the DAC is used in the unipolar or bipolar mode of operation. In unipolar mode, the output amplifier is used in a voltage-follower connection. In bipolar mode (MAX5442/MAX5444 only), the amplifier operates with the internal scaling resistors (Figure 2b). In each mode, the DAC's output resistance is constant and is independent of input code; however, the output amplifier's input impedance should still be as high as possible to minimize gain errors. The DAC's output capacitance is also independent of input code, thus simplifying stability requirements on the external amplifier.

In bipolar mode, a precision amplifier operating with dual power supplies (such as the MAX400) provides the $\pm V_{REF}$ output range. In single-supply applications, precision amplifiers with input common-mode ranges including GND are available; however, their output swings do not normally include the negative rail (GND) without significant degradation of performance. A single-supply op amp, such as the MAX495, is suitable if the application does not use codes near zero.

Since the LSBs for a 16-bit DAC are extremely small (38.15 μ V for $V_{REF} = 2.5V$), pay close attention to the external amplifier's input specification. The input offset voltage can degrade the zero-scale error and might require an output offset trim to maintain full accuracy if the offset voltage is greater than 1/2LSB. Similarly, the input bias current multiplied by the DAC output resistance (typically 6.25k Ω) contributes to the zero-scale error. Temperature effects also must be taken into consideration. Over the -40°C to +85°C extended temperature range, the offset voltage temperature coefficient (referenced to +25°C) must be less than 0.24 μ V/°C to

add less than 1/2LSB of zero-scale error. The external amplifier's input resistance forms a resistive divider with the DAC output resistance, which results in a gain error. To contribute less than 1/2LSB of gain error, the input resistance typically must be greater than:

$$6.25k\Omega \times 2^{17} = 819M\Omega$$

The settling time is affected by the buffer input capacitance, the DAC's output capacitance, and PC board capacitance. The typical DAC output voltage settling time is 1 μ s for a full-scale step. Settling time can be significantly less for smaller step changes. Assuming a single time-constant exponential settling response, a full-scale step takes 12 time constants to settle to within 1/2LSB of the final output voltage. The time constant is equal to the DAC output resistance multiplied by the total output capacitance. The DAC output capacitance is typically 10pF. Any additional output capacitance will increase the settling time.

The external buffer amplifier's gain-bandwidth product is important because it increases the settling time by adding another time constant to the output response. The effective time constant of two cascaded systems, each with a single time-constant response, is approximately the root square sum of the two time constants. The DAC output's time constant is 1 μ s / 12 = 83ns, ignoring the effect of additional capacitance. If the time constant of an external amplifier with 1MHz bandwidth is $1 / 2\pi (1MHz) = 159ns$, then the effective time constant of the combined system is:

$$\sqrt{[(83ns)^2 + (159ns)^2]} = 180ns$$

This suggests that the settling time to within 1/2LSB of the final output voltage, including the external buffer amplifier, will be approximately $12 \times 180ns = 2.15\mu s$.

Digital Inputs and Interface Logic

The digital interface for the 16-bit DAC is based on a 3-wire standard that is compatible with SPI, QSPI, and MICROWIRE interfaces. The three digital inputs (\overline{CS} , DIN, and SCLK) load the digital input data serially into the DAC.

A 20ns (min) logic-low pulse on \overline{CLR} clears the data in the DAC buffer.

All of the digital inputs include Schmitt-trigger buffers to accept slow-transition interfaces. This means that optocouplers can interface directly to the MAX5441-MAX5444 without additional external logic. The digital inputs are compatible with TTL/CMOS-logic levels.

+3V/+5V, Serial-Input, Voltage-Output, 16-Bit DACs

Unipolar Configuration

Figure 2a shows the MAX5441-MAX5444 configured for unipolar operation with an external op amp. The op amp is set for unity gain, and Table 1 lists the codes for this circuit. The bipolar MAX5442/MAX5444 can also be used in unipolar configuration by connecting RFB and INV to REF. This allows the DAC to power-up to mid-scale.

Bipolar Configuration

Figure 2b shows the MAX5442/MAX5444 configured for bipolar operation with an external op amp. The op amp is set for unity gain with an offset of $-1/2V_{REF}$. Table 2 lists the offset binary codes for this circuit.

Power-Supply Bypassing and Ground Management

Bypass V_{DD} with a $0.1\mu\text{F}$ ceramic capacitor connected between V_{DD} and GND. Mount the capacitor with short leads close to the device (less than 0.25 inches).

Table 1. Unipolar Code Table

DAC LATCH CONTENTS		ANALOG OUTPUT, V_{OUT}
MSB	LSB	
1111	1111 1111 1111	$V_{REF} \times (65,535 / 65,536)$
1000	0000 0000 0000	$V_{REF} \times (32,768 / 65,536) = 1/2V_{REF}$
0000	0000 0000 0001	$V_{REF} \times (1 / 65,536)$
0000	0000 0000 0000	0

Table 2. Bipolar Code Table

DAC LATCH CONTENTS		ANALOG OUTPUT, V_{OUT}
MSB	LSB	
1111	1111 1111 1111	$+V_{REF} \times (32,767 / 32,768)$
1000	0000 0000 0001	$+V_{REF} \times (1 / 32,768)$
1000	0000 0000 0000	0
0111	1111 1111 1111	$-V_{REF} \times (1 / 32,768)$
0000	0000 0000 0000	$-V_{REF} \times (32,768 / 32,768) = -V_{REF}$

+3V/+5V, Serial-Input, Voltage-Output, 16-Bit DACs

Functional Diagrams

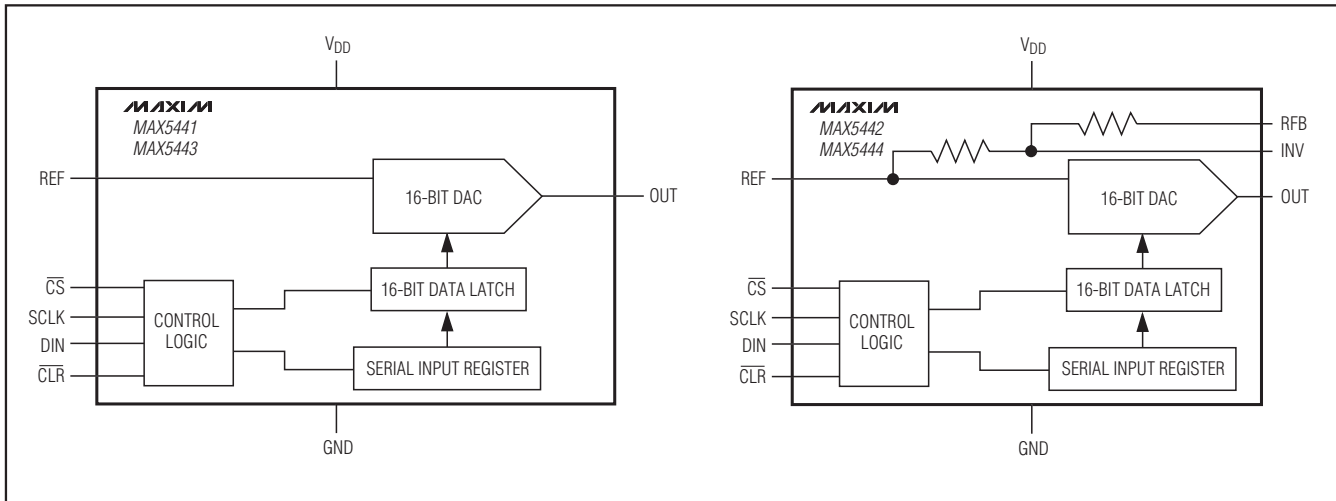

MAX5441-MAX5444

Ordering Information (continued)

PART	TEMP RANGE	PIN-PACKAGE	INL (LSB)	SUPPLY (V)
MAX5443 ACUA+	0°C to +70°C	8 μ MAX	± 2	3
MAX5443AEUA+	-40°C to +85°C	8 μ MAX	± 2	3
MAX5443BCUA+	0°C to +70°C	8 μ MAX	± 4	3
MAX5443BEUA+	-40°C to +85°C	8 μ MAX	± 4	3
MAX5444 ACUB+	0°C to +70°C	10 μ MAX	± 2	3
MAX5444AEUB+	-40°C to +85°C	10 μ MAX	± 2	3
MAX5444BCUB+	0°C to +70°C	10 μ MAX	± 4	3
MAX5444BEUB+	-40°C to +85°C	10 μ MAX	± 4	3

+Denotes a lead(Pb)-free/RoHS-compliant package.

Note: For leaded version, contact factory.

Chip Information

PROCESS: BiCMOS

Package Information

For the latest package outline information and land patterns (footprints), go to www.maxim-ic.com/packages. Note that a "+", "#", or "-" in the package code indicates RoHS status only. Package drawings may show a different suffix character, but the drawing pertains to the package regardless of RoHS status.

PACKAGE TYPE	PACKAGE CODE	OUTLINE NO.	LAND PATTERN NO.
8 μ MAX	U8+1	21-0036	90-0092
10 μ MAX	U10+2	21-0061	90-0330

+3V/+5V, Serial-Input, Voltage-Output, 16-Bit DACs

Revision History

REVISION NUMBER	REVISION DATE	DESCRIPTION	PAGES CHANGED
0	10/00	Initial release	—
2	10/07	Changed timing diagram	6
3	1/09	Added lead-free notation in <i>Ordering Information</i> .	1, 11

Maxim cannot assume responsibility for use of any circuitry other than circuitry entirely embodied in a Maxim product. No circuit patent licenses are implied. Maxim reserves the right to change the circuitry and specifications without notice at any time.

12 **Maxim Integrated Products, 120 San Gabriel Drive, Sunnyvale, CA 94086 408-737-7600**

Looking for pricing, stock, or lifecycle information?

Click below to explore more details on WIN SOURCE:

- ⊖ [View MAX5441ACUA+](#) on WIN SOURCE
- ⊖ [Maxim Integrated](#) Information

Optimize Your Supply Chain with WIN SOURCE Solutions

- ✓ Global Sourcing Solution
- ✓ Obsolete Management
- ✓ Cost Control Management
- ✓ Shortage Management
- ✓ Alternative Solution
- ✓ Excess Inventory Management