





# Regulated 5V USB Charge Pump with Programmable Current Limit

MAX5008

## General Description

The MAX5008 charge-pump regulator generates a regulated 5V output up to 125mA with a 2.95V to 5.5V input voltage range. The device includes resistor-programmable overcurrent limit. The MAX5008 requires a minimum number of external components for normal operation. The high 1MHz switching frequency allows the use of small surface-mount ceramic capacitors.

The fault-protection circuitry limits the output current when it exceeds the limit set by an external resistor. The output current can range from 1mA to 150mA to accommodate circuit requirements. A FAULT output indicates when the device is in current limit or the output is out of regulation.

A low-power shutdown mode reduces supply current to less than 1 $\mu$ A and places the output in a high-impedance state. The MAX5008 is offered in a space-saving 10-pin  $\mu$ MAX<sup>®</sup> package that is only 1.1mm high.

## Applications

Flash Memory Supplies  
 USB Host Devices  
 Battery-Powered Systems  
 3.3V to 5V Local Conversion

$\mu$ MAX is a registered trademark of Maxim Integrated Products, Inc.

## Features

- ◆ Regulated 5V Output Up to 125mA
- ◆ Indefinite Short-Circuit Protection
- ◆ Adjustable Output Current Limit
- ◆ No Inductors Required
- ◆ 0.1 $\mu$ A Shutdown Current
- ◆ Thermal Shutdown
- ◆ Fault Output Indicates Overcurrent or Output Voltage Out of Regulation
- ◆ 2.95V to 5.5V Input Voltage Range
- ◆ 10-Pin  $\mu$ MAX Package

## Ordering Information

PART	TEMP RANGE	PIN-PACKAGE
MAX5008CUB	0°C to +70°C	10 $\mu$ MAX

Pin Configuration appears at end of data sheet.

## Typical Operating Circuit

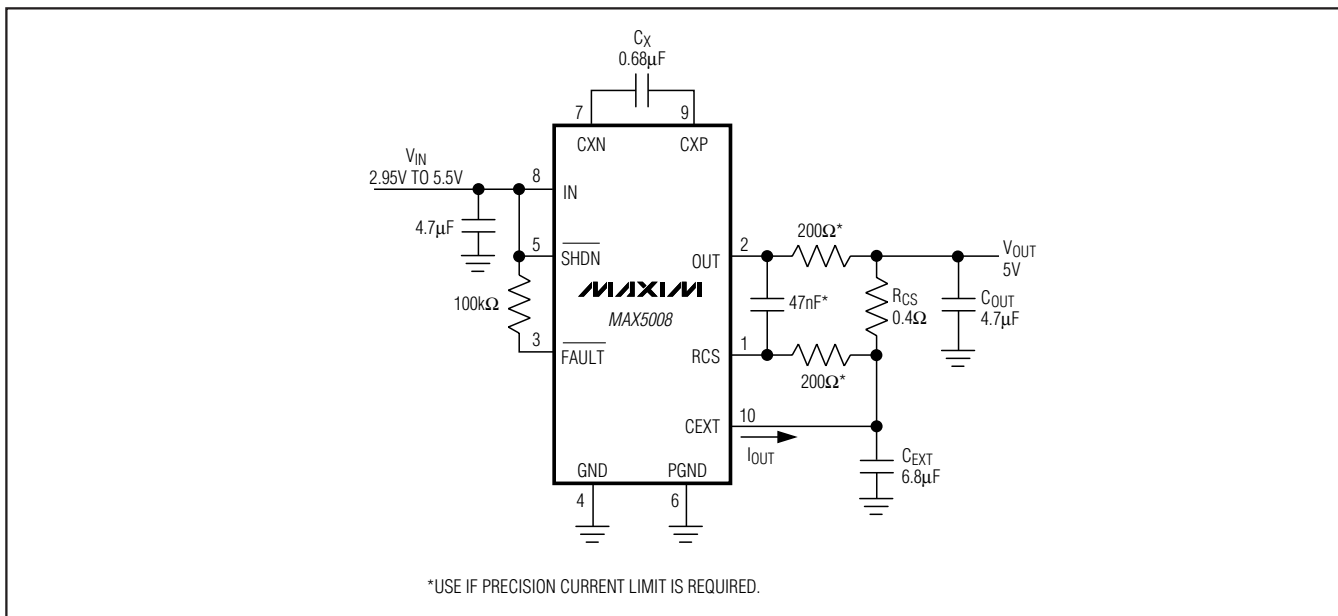

# Regulated 5V USB Charge Pump with Programmable Current Limit

## ABSOLUTE MAXIMUM RATINGS

IN, SHDN, RCS, FAULT, OUT to GND .....-0.3V to +6V  
 PGND to GND .....±0.3V  
 CXN to GND .....-0.3V to (VIN + 0.3V)  
 CXP to GND .....-0.3V to (VCEXT + 0.3V)  
 CEEXT to GND .....-0.3V to (VCEXT + 0.3V)  
 Short-Circuit Duration to GND .....Indefinite

Continuous Power Dissipation (TA = +70°C)

10-Pin μMAX .....444mW  
 Operating Temperature Range .....0°C to +70°C  
 Junction Temperature .....+150°C  
 Storage Temperature Range .....-65°C to +150°C  
 Lead Temperature (soldering, 10s) .....+300°C

Stresses beyond those listed under "Absolute Maximum Ratings" may cause permanent damage to the device. These are stress ratings only, and functional operation of the device at these or any other conditions beyond those indicated in the operational sections of the specifications is not implied. Exposure to absolute maximum rating conditions for extended periods may affect device reliability.

## ELECTRICAL CHARACTERISTICS

(VIN = SHDN = 3V, CIN = 4.7μF, CX = 0.68μF, CEEXT = 6.8μF, COUT = 4.7μF, RCS = 0.4Ω, TA = 0°C to +70°C, unless otherwise noted. Typical values are at TA = +25°C.)

PARAMETER	SYMBOL	CONDITIONS	MIN	TYP	MAX	UNITS
Input Voltage Range (Note 1)	VIN	IOUT = 125mA, 4.75V ≤ VOUT ≤ 5.25V	2.95		4.25	V
		IOUT = 70mA	2.95		5.50	
Input Undervoltage Lockout Threshold		Rising edge	2.0	2.35	2.6	V
Input Undervoltage Lockout Hysteresis		Falling edge		100		mV
Output Voltage (Note 2)	VOUT	0 ≤ IOUT < 30mA, 2.95V < VIN < 5.5V	4.75	5.0	5.30	V
		0mA ≤ IOUT ≤ 125mA, 2.95V ≤ VIN ≤ 4.25V	4.75	5.0	5.25	
Output Voltage Ripple	VRIP	0mA ≤ IOUT ≤ 125mA		100		mV
VOUT Fault Threshold	VTH	VOUT = 5V (nominal), no load	82.5		92.5	%VOUT
Maximum Output Current	IOUT	VOUT = 5V ±4%	100	140		mA
No-Load Input Current	IQ	IOUT = 0, VIN = 4.25V		0.6	6	mA
		IOUT = 0, VIN = 3.3V		1	6	
SHDN Logic High	VINH,SHDN		2.4			V
SHDN Logic Low	VINL,SHDN				0.4	V
Shutdown Supply Current	IQSHDN	SHDN = low		0.1	10	μA
Current-Sense Trip Level	VCS	VCS = IOUT × RCS (Note 3)	55	60	73	mV
FAULT Leakage Current		VFAULT = 5V, OUT in regulation			1	μA
FAULT Logic Low		IOUT > ILIMIT, or VOUT < VTH, IFAULT = 1mA			0.4	V
FAULT Assertion Delay (Note 4)	tFD	IOUT > ILIMIT		2		ms
		VOUT < VTH		30		μs
FAULT Deassertion Delay (Note 5)	tFDD	IOUT < ILIMIT and VOUT > 4.5V		16		ms
Switching Frequency			0.5	1	1.5	MHz
Startup Time	tSTART	VOUT > VTH, RLOAD = 46Ω, from rising edge of SHDN		200		μs

# Regulated 5V USB Charge Pump with Programmable Current Limit

## ELECTRICAL CHARACTERISTICS (continued)

( $V_{IN} = \overline{SHDN} = 3V$ ,  $C_{IN} = 4.7\mu F$ ,  $C_X = 0.68\mu F$ ,  $C_{EXT} = 6.8\mu F$ ,  $C_{OUT} = 4.7\mu F$ ,  $R_{CS} = 0.4\Omega$ ,  $T_A = 0^\circ C$  to  $+70^\circ C$ , unless otherwise noted. Typical values are at  $T_A = +25^\circ C$ .)

PARAMETER	SYMBOL	CONDITIONS	MIN	TYP	MAX	UNITS
Thermal Shutdown Junction Temperature				150		$^\circ C$
Thermal Shutdown Hysteresis				30		$^\circ C$

**Note 1:** When the input exceeds 4.25V, the power dissipation on the chip exceeds the maximum rating if the output current is 125mA.

**Note 2:** The MIN/MAX limits are 100% production tested at  $+25^\circ C$  and  $+70^\circ C$ , and guaranteed by design at  $0^\circ C$ .

**Note 3:**  $I_{OUT}$  is output current flowing from  $C_{EXT}$ .

**Note 4:** The delay from the fault event to the assertion of  $\overline{FAULT}$ . Fault delays are specified with either a current fault or a voltage fault, but not both simultaneously.

**Note 5:** The delay from the removal of the fault event to the deassertion of  $\overline{FAULT}$ .

## Typical Operating Characteristics

( $V_{IN} = 3V$ ,  $C_{IN} = 4.7\mu F$ ,  $C_X = 0.47\mu F$ ,  $C_{OUT} = 4.7\mu F$ ,  $C_{EXT} = 4.7\mu F$ ,  $R_{CS} = 0.4\Omega$ ,  $T_A = +25^\circ C$ , unless otherwise noted.)

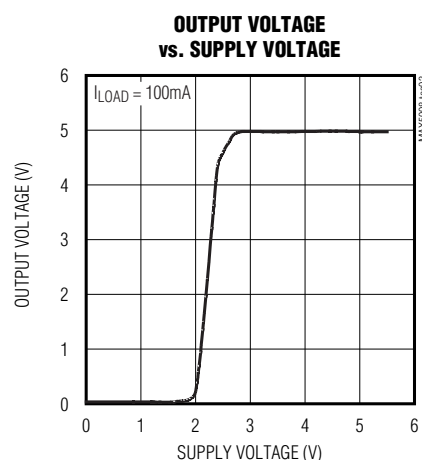
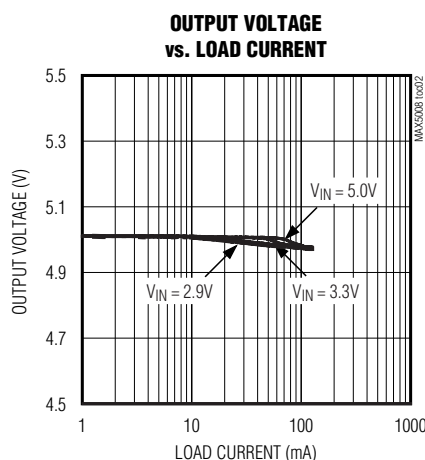
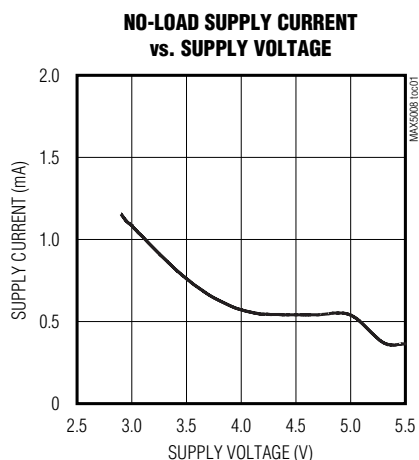

# Regulated 5V USB Charge Pump with Programmable Current Limit

## Typical Operating Characteristics (continued)

( $V_{IN} = 3V$ ,  $C_{IN} = 4.7\mu F$ ,  $C_X = 0.47\mu F$ ,  $C_{OUT} = 4.7\mu F$ ,  $C_{EXT} = 4.7\mu F$ ,  $R_{CS} = 0.4\Omega$ ,  $T_A = +25^\circ C$ , unless otherwise noted.)

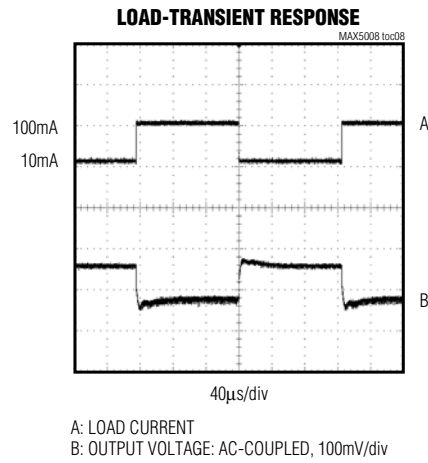
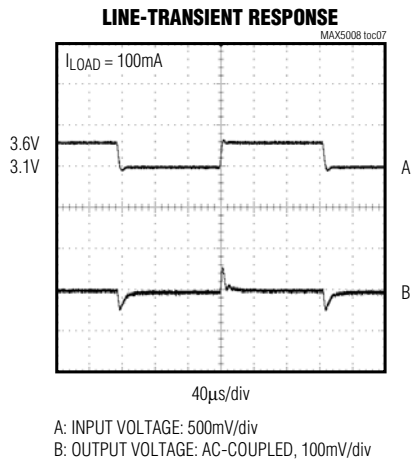
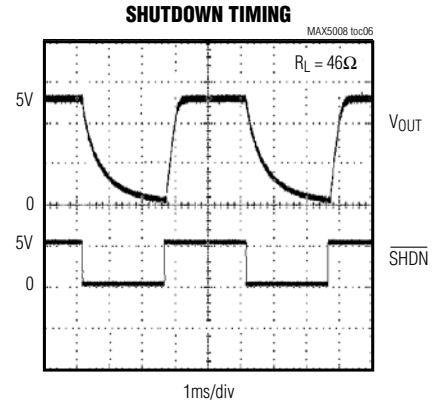
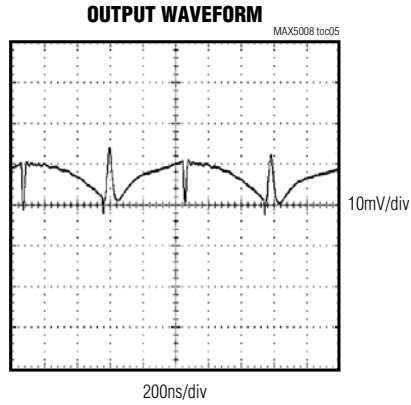
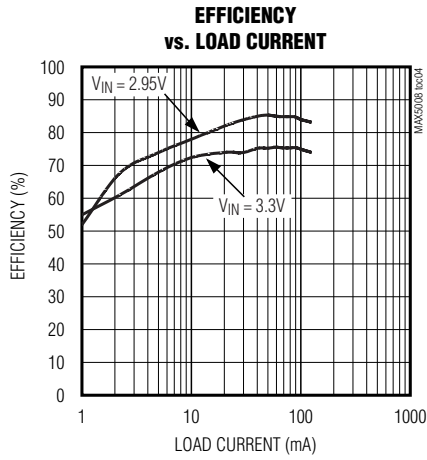

# Regulated 5V USB Charge Pump with Programmable Current Limit

MAX5008

## Pin Description

PIN	NAME	FUNCTION
1	RCS	External Current-Sense Resistor. Connect a resistor from RCS to OUT to set the overcurrent threshold. $I_{LIMIT} = 60\text{mV} / R_{CS}$ .
2	OUT	Fixed 5V Output. Bypass OUT to GND with a 4.7 $\mu\text{F}$ capacitor.
3	$\overline{\text{FAULT}}$	Output Fault Indicator. $\overline{\text{FAULT}}$ is asserted when either $I_{OUT} > I_{LIMIT}$ or $V_{OUT} < V_{TH}$ . $\overline{\text{FAULT}}$ is an open-drain output that is high during normal operation or during shutdown.
4	GND	Ground Pin. Connect GND to PGND.
5	$\overline{\text{SHDN}}$	Shutdown Input. When $\overline{\text{SHDN}} = \text{low}$ , the device turns off. Drive $\overline{\text{SHDN}}$ high or connect to IN for normal operation.
6	PGND	Power Ground Pin. Connect PGND to GND.
7	CXN	Negative Terminal of the Charge-Pump Capacitor. Connect a 0.68 $\mu\text{F}$ capacitor from CXN to CXP.
8	IN	Input Supply, 2.95V to 5.5V. Bypass IN to GND with a 4.7 $\mu\text{F}$ ceramic capacitor.
9	CXP	Positive Terminal of the Charge-Pump Capacitor. Connect a 0.68 $\mu\text{F}$ capacitor from CXP to CXN.
10	CEXT	Charge-Pump Output. Bypass CEXT to PGND with a 6.8 $\mu\text{F}$ capacitor.

## Detailed Description

The MAX5008 charge pump provides a regulated 5V output from a 2.95V to 5.5V input. The device delivers a maximum of 125mA load current. Designed specifically for compact applications, a complete regulator circuit requires a minimum number of external components.

### Adjustable Current Limit

The MAX5008 has an adjustable overcurrent protection. An external current-sense resistor is connected from RCS to OUT to set the current limit. The current limit is defined by:

$$I_{LIMIT} = V_{CS} / R_{CS}$$

where  $V_{CS}$  is the current-sense trip level, typically 60mV. For example,  $I_{LIMIT} = 150\text{mA}$  when  $R_{CS} = 0.40\Omega$ .

When the output current limit is exceeded, the output voltage falls and the device maintains the average output current at  $I_{LIMIT}$ . Upon removal of the overcurrent condition, the part resumes normal operation.

### FAULT Indication

When  $I_{OUT} > I_{LIMIT}$  or  $V_{OUT} < V_{TH}$ ,  $\overline{\text{FAULT}}$  asserts.  $\overline{\text{FAULT}}$  is an open-drain output that needs to be connected through a 100k $\Omega$  (typ) pullup resistor to a logic supply voltage.

### Thermal Shutdown

The MAX5008 has internal thermal shutdown circuitry, which shuts down the device when the die temperature exceeds +150°C. The thermal shutdown circuitry has 30°C hysteresis.

## Shutdown Mode

Driving  $\overline{\text{SHDN}}$  low places the device in shutdown mode, which disables the oscillator, the control logic, and the reference. The output goes into high-impedance state and drops to ground if loaded. Placing the device in shutdown mode reduces the supply current to less than 0.1 $\mu\text{A}$ . In normal operation,  $\overline{\text{SHDN}}$  is driven high or connected to IN.

## Applications Information

### Capacitor Selection

The MAX5008 requires four external capacitors. Their values depend on the required output current. Table 1 shows the capacitor values recommended for different load currents.

### Input Voltage Range

The MAX5008 maintains a regulated 5V output with input voltages from 2.95V to 5.5V. If the input voltage exceeds 4.25V, limit the output current to 75mA or less. This keeps the MAX5008 within its maximum power dissipation limits.

**Table 1. Recommended Capacitor Values**

$I_{OUT}$	$C_{IN}$ ( $\mu\text{F}$ )	$C_X$ ( $\mu\text{F}$ )	$C_{EXT}$ ( $\mu\text{F}$ )	$C_{OUT}$ ( $\mu\text{F}$ )
50mA	3.3	0.33	3.3	3.3
125mA	4.7	0.68	6.8	4.7

### Layout Considerations

All capacitors should be located as close to the IC as practical. Connect GND and PGND through a short,

# Regulated 5V USB Charge Pump with Programmable Current Limit

## Functional Diagram

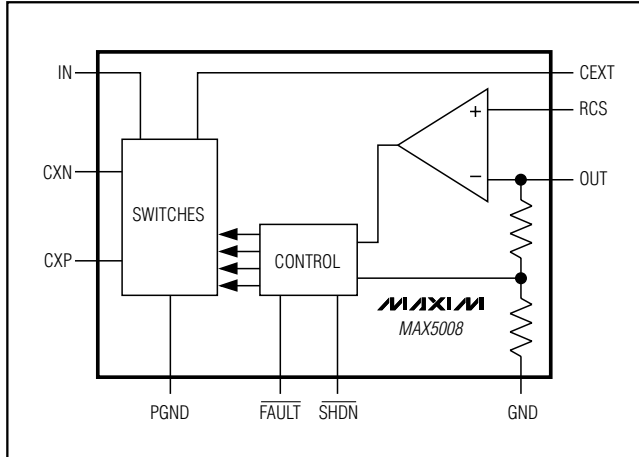

low-impedance trace, and connect the ground for  $C_{IN}$ ,  $C_{EXT}$ , and  $C_{OUT}$  directly to PGND in a star configuration. Connect  $R_{CS}$  to  $C_{EXT}$  through a short and low impedance trace.

## Pin Configuration

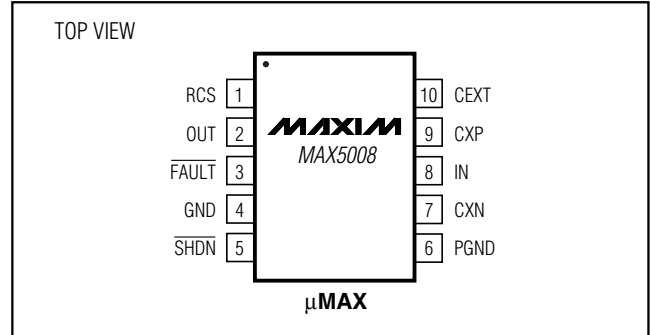

## Chip Information

TRANSISTOR COUNT: 2632  
 PROCESS: BiCMOS

# Regulated 5V USB Charge Pump with Programmable Current Limit

## Package Information

(The package drawing(s) in this data sheet may not reflect the most current specifications. For the latest package outline information, go to [www.maxim-ic.com/packages](http://www.maxim-ic.com/packages).)

**MAX5008**

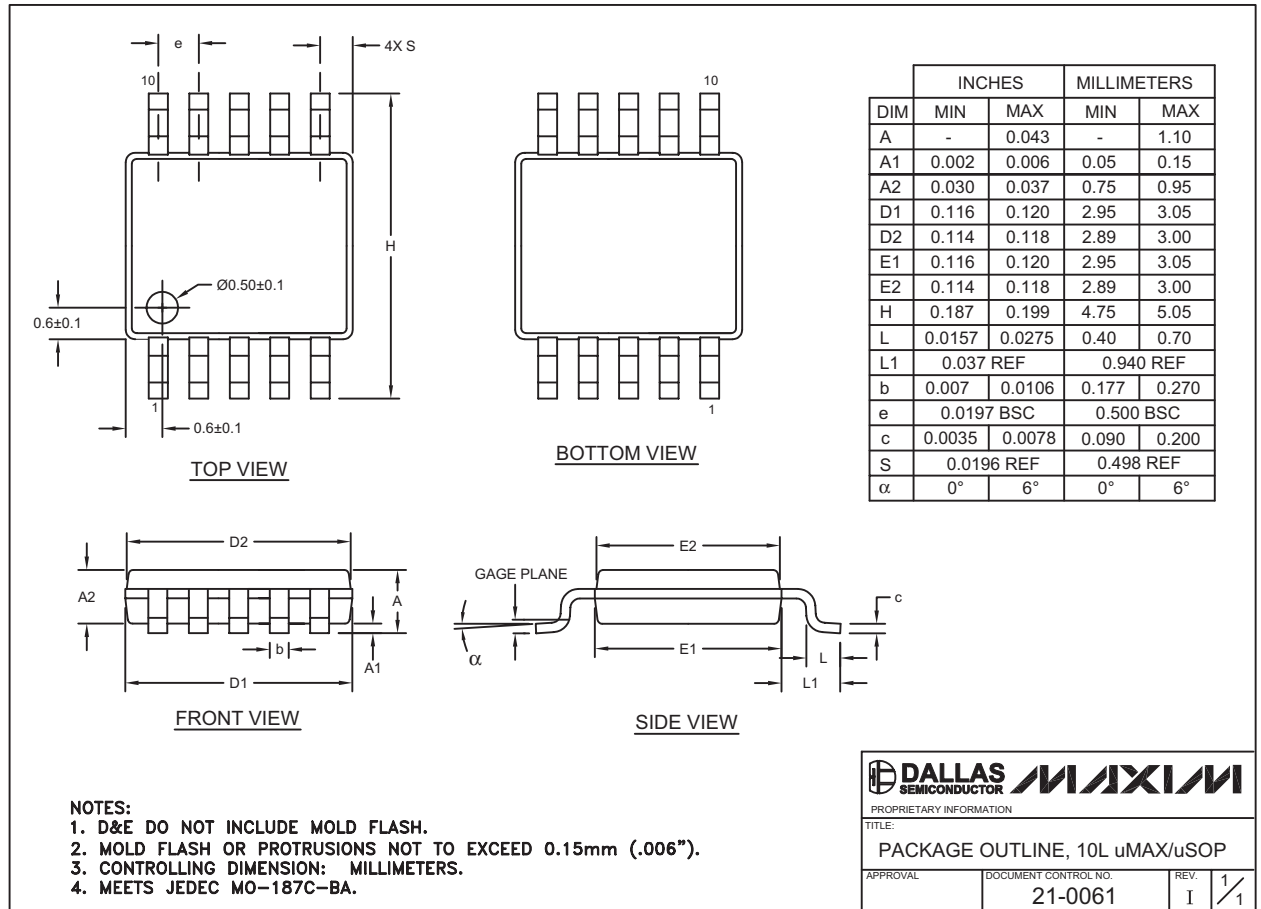

## Revision History



Pages changed at Rev 1: 1, 2, 7

Maxim cannot assume responsibility for use of any circuitry other than circuitry entirely embodied in a Maxim product. No circuit patent licenses are implied. Maxim reserves the right to change the circuitry and specifications without notice at any time.

Maxim Integrated Products, 120 San Gabriel Drive, Sunnyvale, CA 94086 408-737-7600 7

## Looking for pricing, stock, or lifecycle information?

Click below to explore more details on WIN SOURCE:

-  [View MAX5008CUB+T on WIN SOURCE](#)
-  [Maxim Integrated Information](#)

## Optimize Your Supply Chain with WIN SOURCE Solutions

-  Global Sourcing Solution
-  Obsolete Management
-  Cost Control Management
-  Shortage Management
-  Alternative Solution
-  Excess Inventory Management