



**THE DATASHEET OF  
MAX4772EUT+T**



# MAXIM

## 200mA/500mA Selectable Current-Limit Switches

MAX4772/MAX4773

### General Description

The MAX4772/MAX4773 switches feature selectable internal current limiting to prevent damage to host devices due to faulty load conditions. The MAX4772/MAX4773 include a logic input to select a guaranteed 200mA or 500mA current limit, making them ideal for SDIO and other load-switching applications. These analog switches have a low 0.2Ω on-resistance and operate from a 2.0V to 4.5V input voltage range.

When the switch is on and a load is connected to the port, a guaranteed blanking time of 14ms ensures that the transient voltage settles down. If, after this blanking time, the load current is greater than the current limit, the MAX4772 switch is turned off and issues a FLAG to the microprocessor. The switch can be turned on again by cycling the power or the ON input.

The MAX4773 has an autoretry feature where the switch turns off and issues a FLAG to the microprocessor after the blanking time and then continuously checks to see if the overload condition is present. The switch remains on after the overload condition disappears and FLAG deasserts.

The MAX4772/MAX4773 are available in tiny space-saving 6-pin SOT23 and 6-pin TDFN (3mm x 3mm) packages.

### Applications

SDIO  
PDAs and Palmtop Devices  
Cell Phones  
GPS Systems  
Hand-Held Devices

### Typical Operating Circuit

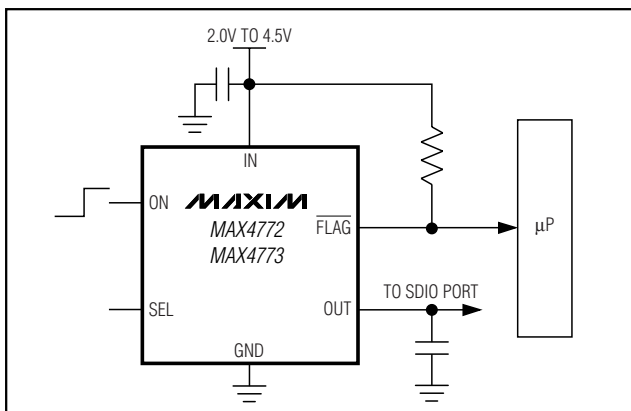

### Features

- ◆ Guaranteed Current Limit: 200mA or 500mA
- ◆ Thermal-Shutdown Protection
- ◆ Reverse-Current Protection
- ◆ 0.2Ω On-Resistance (SEL = High)
- ◆ 14ms Guaranteed Blanking Time
- ◆ FLAG Function
- ◆ Autoretry (MAX4773)
- ◆ 80μA Supply Current
- ◆ 6μA Latch-Off Current (MAX4772)
- ◆ 0.01μA Shutdown Current
- ◆ 2.0V to 4.5V Supply Range
- ◆ Fast Current-Limit Response Time
- ◆ Tiny SOT23 and TDFN Packages
- ◆ UL Certification Pending

### Ordering Information

PART	TEMP RANGE	PIN-PACKAGE	TOP MARK
MAX4772EUT-T	-40°C to +85°C	6 SOT23-6	ABND
MAX4772ETT*	-40°C to +85°C	6 TDFN-EP**	—
MAX4773EUT-T	-40°C to +85°C	6 SOT23-6	ABNE
MAX4773ETT*	-40°C to +85°C	6 TDFN-EP**	—

\*Future product—contact factory for availability.

\*\*EP—Exposed pad.

### Selector Guide

PART	AUTORETRY
MAX4772EUK-T	No
MAX4772ETT	No
MAX4773EUK-T	Yes
MAX4773ETT	Yes

### Pin Configurations

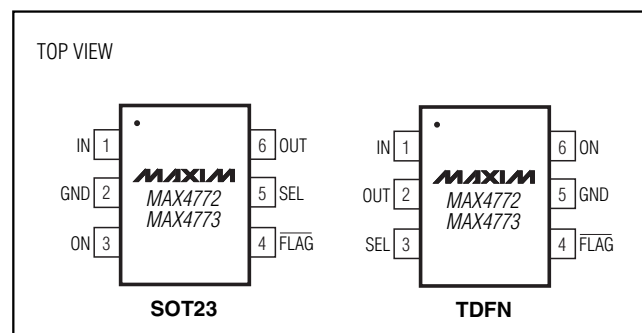

MAXIM

Maxim Integrated Products 1

For pricing, delivery, and ordering information, please contact Maxim/Dallas Direct! at 1-888-629-4642, or visit Maxim's website at [www.maxim-ic.com](http://www.maxim-ic.com).

# 200mA/500mA Selectable Current-Limit Switches

## ABSOLUTE MAXIMUM RATINGS

IN, ON,  $\overline{\text{FLAG}}$ , SEL, OUT to GND ..... -0.3V to +6V  
 OUT Short Circuit to GND ..... Internally Limited  
 Continuous Power Dissipation ( $T_A = +70^\circ\text{C}$ )  
 6-Pin SOT23 (derate 8.7mW/ $^\circ\text{C}$  above +70 $^\circ\text{C}$ ) ..... 696mW  
 6-Pin TDFN (derate 24.4mW/ $^\circ\text{C}$  above +70 $^\circ\text{C}$ ) ..... 1951mW

Operating Temperature Range ..... -40 $^\circ\text{C}$  to +85 $^\circ\text{C}$   
 Junction Temperature ..... +150 $^\circ\text{C}$   
 Storage Temperature Range ..... -65 $^\circ\text{C}$  to +150 $^\circ\text{C}$   
 Lead Temperature (soldering, 10s) ..... +300 $^\circ\text{C}$

Stresses beyond those listed under "Absolute Maximum Ratings" may cause permanent damage to the device. These are stress ratings only, and functional operation of the device at these or any other conditions beyond those indicated in the operational sections of the specifications is not implied. Exposure to absolute maximum rating conditions for extended periods may affect device reliability.

## ELECTRICAL CHARACTERISTICS

( $V_{IN} = +2.0\text{V}$  to +4.5V,  $T_A = -40^\circ\text{C}$  to +85 $^\circ\text{C}$ , unless otherwise noted. Typical values are at  $V_{IN} = +3.3\text{V}$ ,  $T_A = +25^\circ\text{C}$ .) (Note 1)

PARAMETER	SYMBOL	CONDITIONS	MIN	TYP	MAX	UNITS
Operating Voltage	$V_{IN}$		2.0		4.5	V
Quiescent Current	$I_Q$	$V_{ON} = V_{IN}$ , switch on $V_{IN} = +3.3\text{V}$		80	125	$\mu\text{A}$
Latch-Off Current (Note 2)	$I_{LATCH}$	$V_{ON} = V_{IN}$ , after an overcurrent fault (MAX4772) $V_{IN} = +3.3\text{V}$		6	10	$\mu\text{A}$
Shutdown Current	$I_{SHDN}$	$V_{ON} = 0\text{V}$ , SEL = low or floating		0.03	1	$\mu\text{A}$
Forward-Current Limit		SEL = low, $V_{IN} = 3.3\text{V}$ , $V_{OUT} = \text{GND}$	200		320	mA
		SEL = high, $V_{IN} = 3.3\text{V}$ , $V_{OUT} = \text{GND}$	500		800	
Reverse-Current Limit		SEL = low			320	mA
		SEL = high			800	
ON Input Leakage			-1		+1	$\mu\text{A}$
Shutdown Forward Leakage		$V_{ON} = 0\text{V}$ , $V_{OUT} = 0\text{V}$		0.01	1	$\mu\text{A}$
Shutdown Reverse Leakage		$V_{ON} = 0\text{V}$ , $V_{IN} = 2\text{V}$ , $V_{OUT} = 4.5\text{V}$			1	$\mu\text{A}$
SEL Pulldown Current		After power-up ( $V_{IN} > 2\text{V}$ , $0\text{V} < V_{SEL} < 0.5\text{V}$ )	30		100	$\mu\text{A}$
SEL Input Current		Measured after first low-to-high transition	-1		+1	$\mu\text{A}$
On-Resistance (Note 3)	$R_{ON}$	SEL = low, $I_{LOAD} = 100\text{mA}$		0.45	0.9	$\Omega$
		SEL = high, $I_{LOAD} = 100\text{mA}$		0.18	0.36	
ON, SEL Input Logic High Voltage	$V_{IH}$	$V_{IN} = 2\text{V}$ to 3.6V	1.4			V
		$V_{IN} > 3.6\text{V}$	2			
ON, SEL Input Logic Low Voltage	$V_{IL}$				0.5	V
$\overline{\text{FLAG}}$ Output Logic Low Voltage		$I_{SINK} = 1\text{mA}$			0.4	V
$\overline{\text{FLAG}}$ Output High Leakage Current		$V_{IN} = V_{\overline{\text{FLAG}}} = V_{ON} = 4.5\text{V}$			1	$\mu\text{A}$
Thermal Shutdown				150		$^\circ\text{C}$
Thermal-Shutdown Hysteresis				15		$^\circ\text{C}$
<b>DYNAMIC</b>						
Turn-On Time (Note 4)		$V_{ON}$ from low to high, $I_{OUT} = 10\text{mA}$ , $C_L = 0.1\mu\text{F}$		120		$\mu\text{s}$
Turn-Off Time (Note 4)		$V_{ON}$ from high to low, $I_{OUT} = 10\text{mA}$ , $C_L = 0.1\mu\text{F}$		100		ns
Blanking Time	$t_{BLANK}$	Overcurrent fault (Figures 4 and 5)	14		60	ms

# 200mA/500mA Selectable Current-Limit Switches

MAX4772/MAX4773

## ELECTRICAL CHARACTERISTICS (continued)

( $V_{IN} = +2.0V$  to  $+4.5V$ ,  $T_A = -40^{\circ}C$  to  $+85^{\circ}C$ , unless otherwise noted. Typical values are at  $V_{IN} = +3.3V$ ,  $T_A = +25^{\circ}C$ .) (Note 1)

PARAMETER	SYMBOL	CONDITIONS	MIN	TYP	MAX	UNITS
Short-Circuit Current-Limit Response Time		$V_{ON} = V_{IN}$ , short circuit applied to OUT		5		$\mu s$
Retry Time (Note 5)	$t_{RETRY}$	MAX4773 (Figure 4)	210		900	ms

**Note 1:** All parts are 100% tested at  $+25^{\circ}C$ . Electrical limits across the full temperature range are guaranteed by design and correlation.

**Note 2:** Latch-off current does not include the current flowing into  $\overline{FLAG}$ .

**Note 3:** TDFN parts are guaranteed by design.

**Note 4:** The on-time is defined as the time taken for the current through the switch to go from 0mA to full load. The off-time is defined as the time taken for the current through the switch to go from full load to 0mA.

**Note 5:** Retry time is typically 15 times the blanking time (typ).

## Typical Operating Characteristics

( $V_{IN} = 3.3V$ ,  $T_A = +25^{\circ}C$ , unless otherwise noted.)

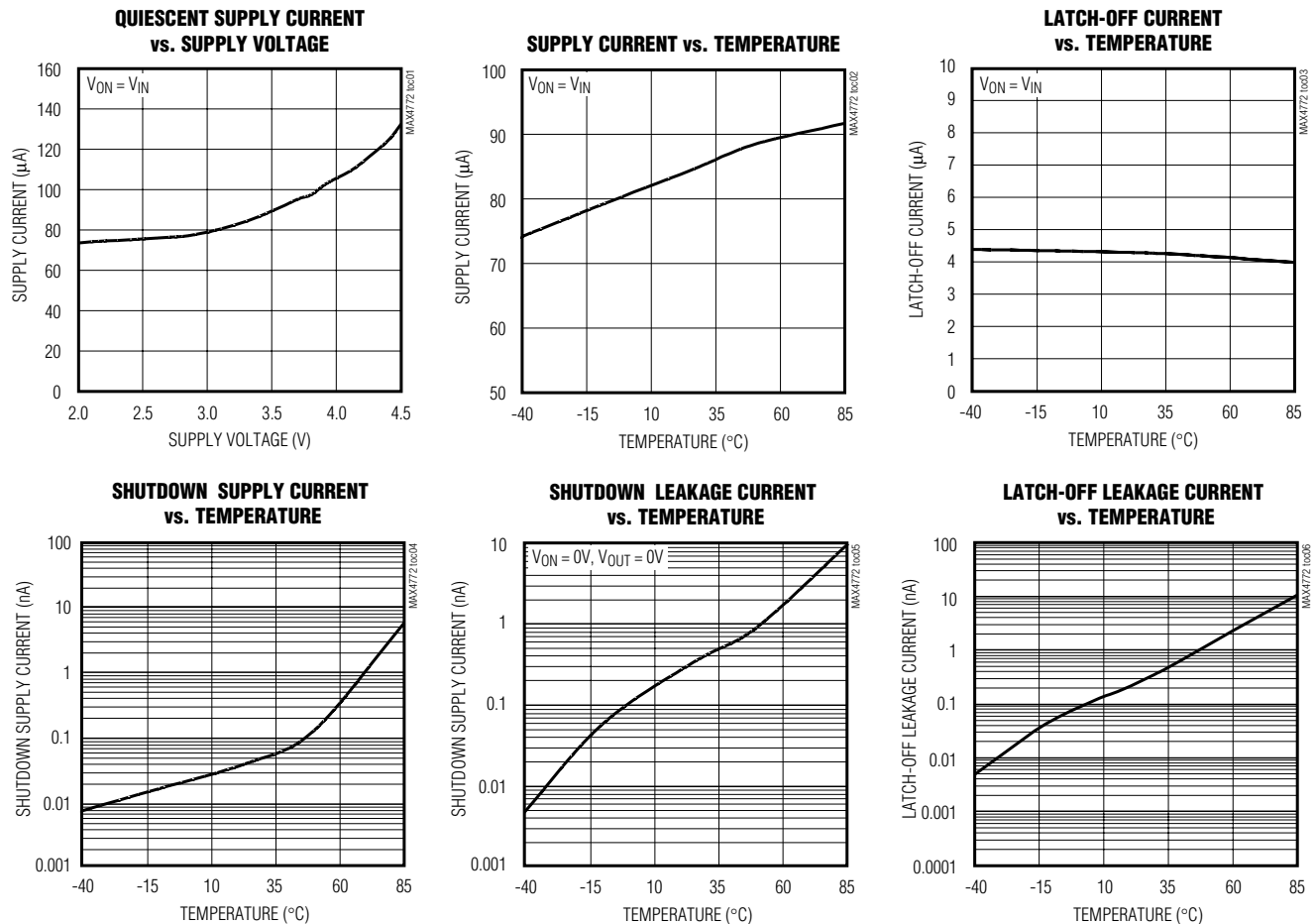

# 200mA/500mA Selectable Current-Limit Switches

## Typical Operating Characteristics (continued)

( $V_{IN} = 3.3V$ ,  $T_A = +25^\circ C$ , unless otherwise noted.)

**SHUTDOWN REVERSE LEAKAGE CURRENT vs. TEMPERATURE**

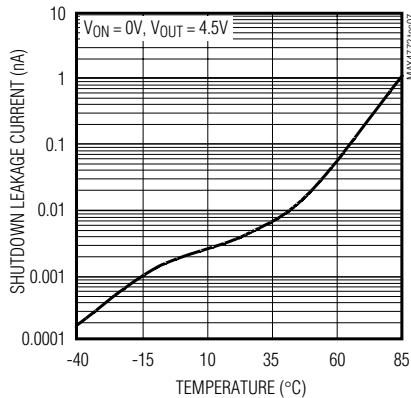

**NORMALIZED ON-RESISTANCE vs. TEMPERATURE**

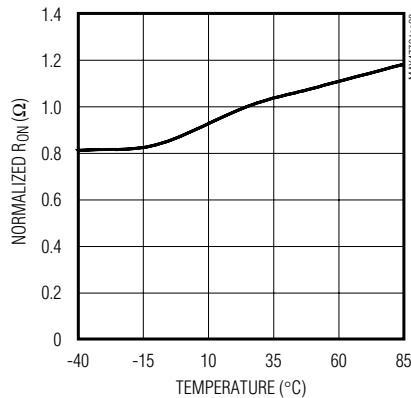

**OUTPUT CURRENT vs. OUTPUT VOLTAGE**

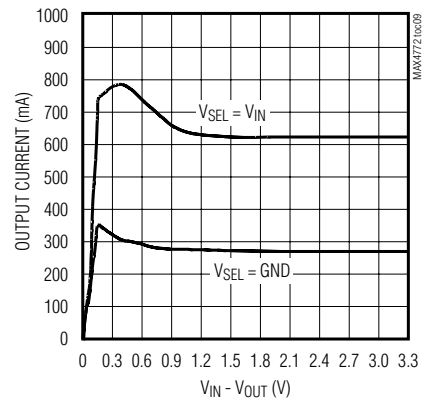

**FORWARD CURRENT LIMIT vs. SUPPLY VOLTAGE**

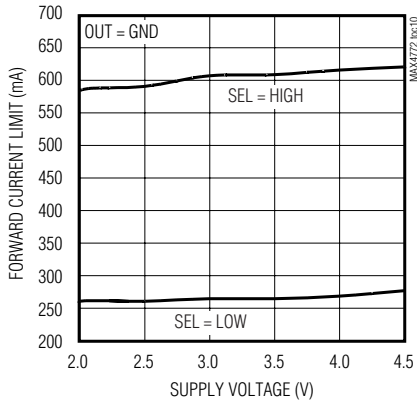

**SWITCH TURN-ON/OFF TIMES vs. TEMPERATURE**

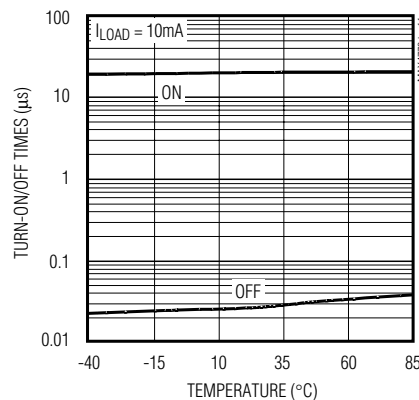

**FLAG-BLANKING TIMEOUT vs. TEMPERATURE**

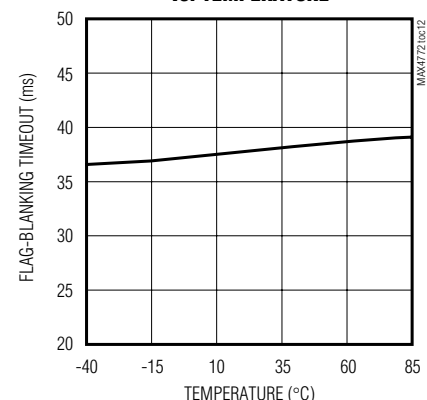

**CURRENT-LIMIT RESPONSE**

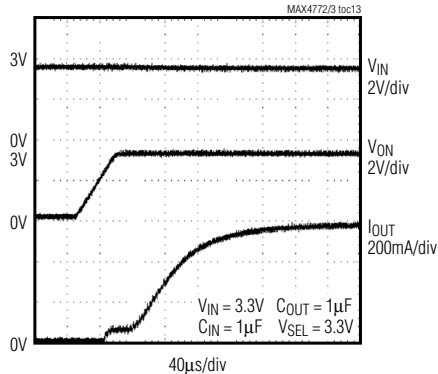

**CURRENT-LIMIT RESPONSE**

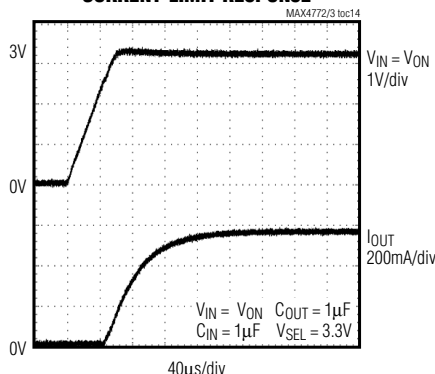

**CURRENT-LIMIT RESPONSE (OUT SHORTED TO GND)**

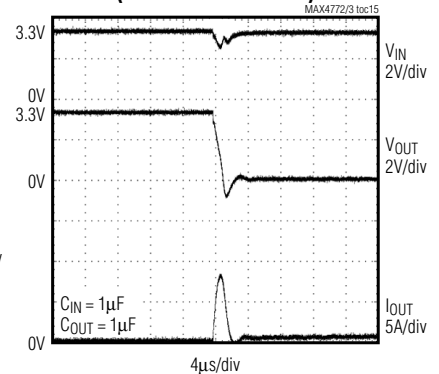

# 200mA/500mA Selectable Current-Limit Switches

MAX4772/MAX4773

## Typical Operating Characteristics (continued)

( $V_{IN} = 3.3V$ ,  $T_A = +25^\circ C$ , unless otherwise noted.)

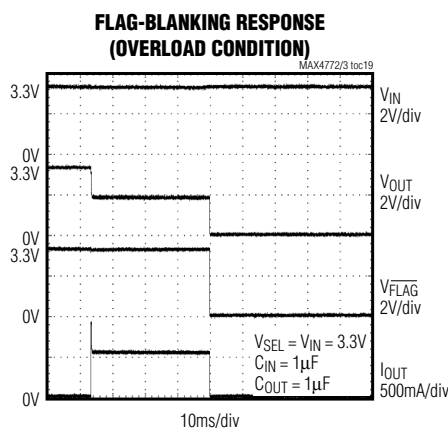
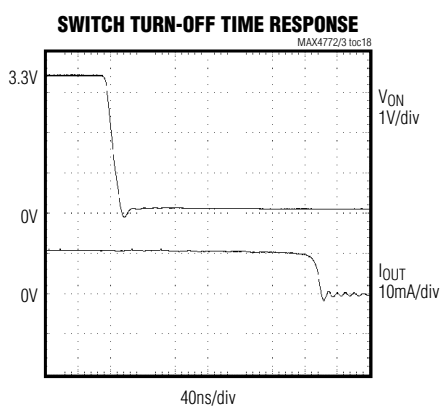
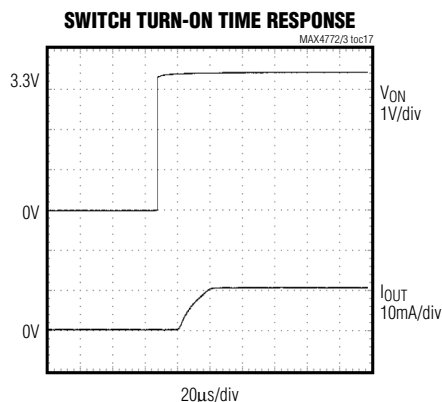
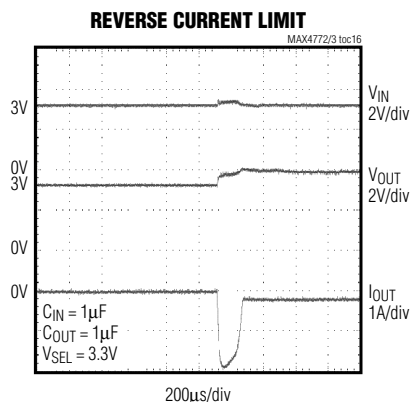

## Pin Description

PIN		NAME	FUNCTION
SOT23	TDFN		
1	1	IN	Input. Bypass with a 0.1µF ceramic capacitor to ground.
2	5	GND	Ground
3	6	ON	Active-High Switch-On Input. A logic high turns the switch on.
4	4	FLAG	Fault Output. This open-drain output goes low when the device stays in forward or reverse current limit for more than the blanking time period. FLAG is high impedance when a fault is not present or when ON is low.
5	3	SEL	Current-Limit Threshold Selection. Connect to logic-low level or leave floating to select 200mA current-limit threshold. Connect to logic-high level to select 500mA current-limit threshold.
6	2	OUT	Switch Output. Bypass with a 0.1µF ceramic capacitor to ground.

## 200mA/500mA Selectable Current-Limit Switches

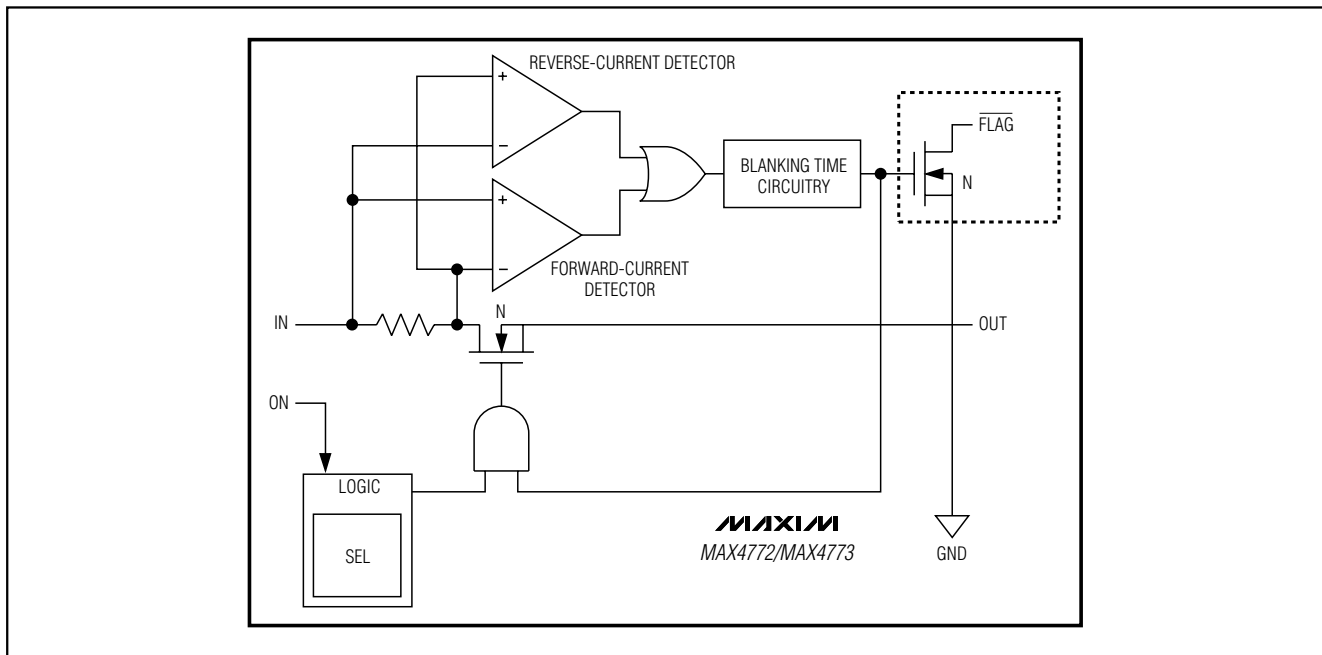

Figure 1. Functional Diagram

### Detailed Description

The MAX4772/MAX4773 are forward/reverse current-limited switches that operate from a 2.0V to 4.5V input voltage range and guarantee a 200mA or 500mA minimum current-limit threshold when driving SEL low or high, respectively. The voltage drop across an internal sense resistor is compared to two reference voltages to indicate a forward or reverse current-limit fault. When the load current exceeds the preset current limit for greater than the fault-blanking time, the switch opens.

The MAX4773 has an autoretry function that turns on the switch again after an internal retry time expires. If the faulty load condition is still present after the blanking time, the switch turns off again and the cycle is repeated. If the faulty load condition is not present, the switch remains on.

The MAX4772 does not have the autoretry option and the switch remains in latch-off mode until the ON pin or the input power is cycled from high to low and then high again.

### Current-Limit Threshold Selection

The MAX4772/MAX4773 SEL logic input sets the desired minimum current-limit threshold to 200mA or 500mA. Connect SEL low or leave floating for 200mA current limit and high for the 500mA current limit.

During power-up, if SEL is low or floating, the current limit is set to 200mA. The MAX4772/MAX4773 uses an internal pulldown resistor (100 $\mu$ A, max) to set the default current limit to 200mA when SEL is floating. After the first low-to-high transition, the pulldown resistor is internally disconnected and the level on SEL determines the current limit (SEL = low, 200mA and SEL = high, 500mA).

During power-up, if SEL and  $V_{IN}$  rise together, the current limit is immediately set to 500mA.

Figures 2 and 3 illustrate the two different modes of power-up sequence for the MAX4772/MAX4773. In Figure 2, the switch powers up,  $V_{IN} \geq 2V$ , a low-to-high transition on SEL changes the current limit from 200mA to 500mA. In Figure 3, the switch powers up in the 500mA current-limit mode with SEL and IN rising simultaneously.

The microprocessor's GPIO must be able to source the 100 $\mu$ A drive current for the MAX4772/MAX4773 500mA current-limit operation. After the current limit has been set to 500mA, the 100 $\mu$ A driving current is no longer needed.

# 200mA/500mA Selectable Current-Limit Switches

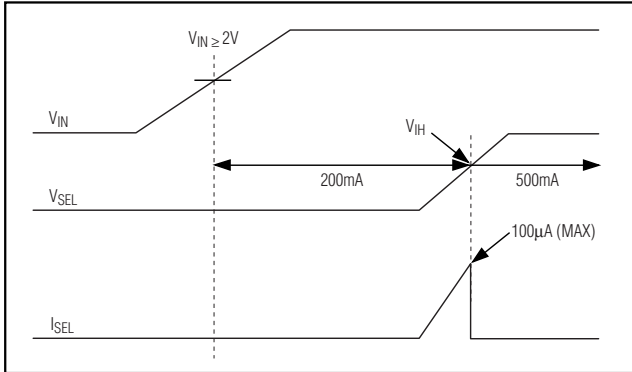

Figure 2. MAX4772/MAX4773 Power-Up Sequence ( $V_{SEL}$  Rises after Power-Up)

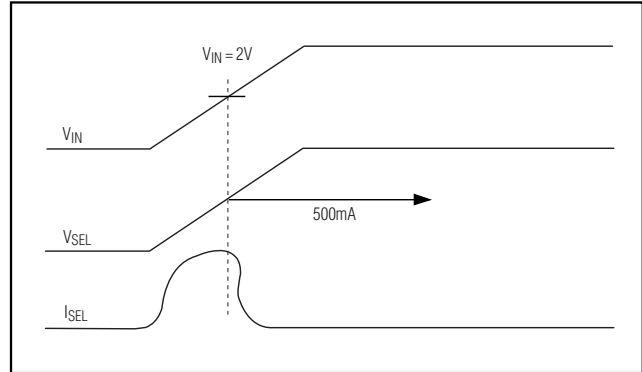

Figure 3. MAX4772 Power-Up Sequence ( $V_{SEL}$  and  $V_{IN}$  Rise Simultaneously)

## Reverse-Current Protection

The MAX4772/MAX4773 limit the reverse current ( $V_{OUT}$  to  $V_{IN}$ ) from exceeding the maximum  $I_{REV}$  value. The switch is shut off and  $\overline{FLAG}$  is asserted if the reverse current-limit condition persists for more than the blanking time. This feature prevents excessive reverse currents from flowing through the device.

## Switch-On/Off Control

Toggle ON high to enable the current-limited switches. When a forward/reverse current fault is present or the die exceeds the thermal-shutdown temperature of  $+150^{\circ}\text{C}$ , OUT is internally disconnected from IN and the supply current decreases to  $8\mu\text{A}$  (latch off). The switch is now operating in one of its off states. The switch-off state also occurs when driving ON low, thus reducing the supply current (shutdown) to  $0.01\mu\text{A}$ . Table 1 illustrates the ON/OFF state of the MAX4772/MAX4773 current-limit switches.

## FLAG Indicator

The MAX4772/MAX4773 feature a fault output ( $\overline{FLAG}$ ). Whenever an overcurrent condition is encountered, the MAX4772 latches  $\overline{FLAG}$  low and turns the switch off. The MAX4773 latches  $\overline{FLAG}$  low and keeps it low until the overcurrent condition is removed. During this time, the switch cycles on and off in the autoretry mode.

When the overcurrent condition is removed,  $\overline{FLAG}$  deasserts and the switch turns on (Figure 4).

$\overline{FLAG}$  is an open-drain output transistor and requires an external pullup resistor from  $\overline{FLAG}$  to IN. During shutdown (ON is low), the pullup on  $\overline{FLAG}$  output is released in order to limit power dissipation.  $\overline{FLAG}$  goes low when any of the following conditions occur:

- The die temperature exceeds the thermal-shutdown temperature limit of  $+150^{\circ}\text{C}$ .
- The device is in current limit for more than the fault-blanking period.
- The switch is in autoretry.

## Autoretry (MAX4773)

When the forward or reverse current-limit threshold is exceeded,  $t_{BLANK}$  timer begins counting (Figure 4). The timer resets if the overcurrent condition disappears before  $t_{BLANK}$  has elapsed. A retry time delay ( $t_{RETRY}$ ) is started immediately after  $t_{BLANK}$  has elapsed and during that time, the switch is latched off and  $\overline{FLAG}$  asserts. At the end of  $t_{RETRY}$ , the switch is turned on again. If the fault still exists, the cycle is repeated. If the fault has been removed, the switch stays on and  $\overline{FLAG}$  deasserts.

Table 1. MAX4772/MAX4773 Switch Truth Table

ON	FAULT	SWITCH ON/OFF	SUPPLY CURRENT MODE
Low	X	OFF	Shutdown
High	Thermal	OFF immediately ( $t_{BLANK}$ period does not apply)	Latch off
High	Current Limit	OFF after $t_{BLANK}$ period has elapsed	Latch off
		ON during $t_{BLANK}$ period, OFF during $t_{RETRY}$ period for the MAX4773 cycle repeats until fault is removed	See the <i>Autoretry</i> section

## 200mA/500mA Selectable Current-Limit Switches

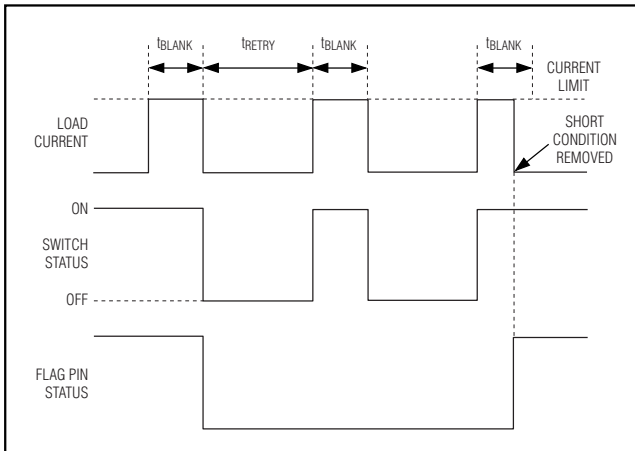

Figure 4. MAX4773 Autoretry Fault-Blanking Diagram

The autoretry feature saves system power in the case of an overcurrent or short-circuit condition. During  $t_{BLANK}$ , when the switch is on, the supply current is at the current limit. During  $t_{RETRY}$ , when the switch is off, the current through the switch is zero. Instead of observing the full load current, the switch sees the equivalent load current times duty cycle or  $I_{SUPPLY} = I_{LOAD} \times t_{BLANK} / (t_{BLANK} + t_{RETRY})$ . With a typical  $t_{BLANK} = 37\text{ms}$  and typical  $t_{RETRY} = 555\text{ms}$ , the duty cycle is 6%, which results in a 94% power savings over the switch being on the entire time. The duty cycle is consistent across the process and devices.

### Latch Off (MAX4772)

When the forward or reverse current-limit threshold is exceeded,  $t_{BLANK}$  timer begins counting. The timer resets if the overcurrent condition disappears before  $t_{BLANK}$  has elapsed. The switch is shut off and  $\overline{FLAG}$  asserts if the overcurrent condition continues up to the end of the blanking time. Reset the switch by either toggling ON (Figure 5) or cycling the input voltage (Figure 5).

### Fault Blanking

The MAX4772/MAX4773 feature 14ms (min) fault blanking. Fault blanking allows current-limit faults, including momentary short-circuit faults that occur when hot swapping a capacitive load, and also ensures that no fault is issued during power-up. When a load transient causes the device to enter current limit, an internal counter starts. If the load-transient fault persists beyond the fault-blanking timeout,  $\overline{FLAG}$  asserts low. Load-transient faults less than  $t_{BLANK}$  do not cause a  $\overline{FLAG}$  output assertion. Only current-limit faults are blanked.

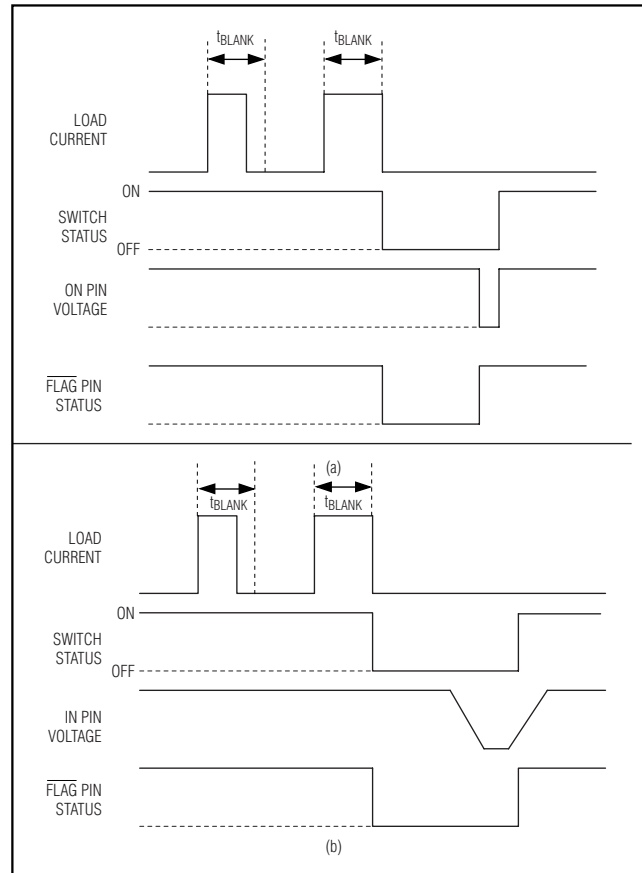

Figure 5. MAX4773 Latch-Off Fault Blanking

A thermal fault causes  $\overline{FLAG}$  to assert immediately and does not wait for the blanking time.

### Thermal Shutdown

The MAX4772/MAX4773 have a thermal-shutdown feature to protect the devices from overheating. The switch turns off and  $\overline{FLAG}$  goes low immediately (no fault blanking) when the junction temperature exceeds  $+150^{\circ}\text{C}$ . The switch with autoretry turns back on when the device temperature drops approximately  $15^{\circ}\text{C}$ . The switch with the latch off requires ON cycling.

## Applications Information

### Input Capacitor

To limit the input-voltage drop during momentary output short-circuit conditions, connect a capacitor from IN to GND. A  $0.1\mu\text{F}$  ceramic capacitor is adequate for most applications; however, higher capacitor values further

## 200mA/500mA Selectable Current-Limit Switches

reduce the voltage drop at the input and are recommended for lower voltage applications.

### Output Capacitance

Connect a 0.1µF capacitor from OUT to GND. This capacitor helps prevent inductive parasitics from pulling OUT negative during turn-off, thus preventing the MAX4772/MAX4773 from tripping erroneously. If the load capacitance is too large, then current may not have enough time to charge the capacitance and the device assumes that there is a faulty load condition. The maximum capacitive load value that can be driven from OUT is obtained by the following formula:

$$C_{MAX} < \frac{I_{FWD\_MIN} \times t_{BLANK\_MIN}}{V_{IN}}$$

### Layout and Thermal Dissipation

To optimize the switch response time to output short-circuit conditions, it is very important to keep all traces as short as possible to reduce the effect of undesirable parasitic inductance. Place input and output capacitors as close as possible to the device (no more than 5mm). IN and OUT pins must be connected with short traces to the power bus.

During normal operation, the power dissipation is small and the package temperature change is minimal. If the output is continuously shorted to ground at the maximum supply voltage, the operation of the switches with the autoretry option does not cause problems because the total power dissipated during the short is scaled by the duty cycle:

$$P_{MAX} = \frac{V_{IN\_MAX} \times I_{OUT\_MAX} \times t_{BLANK}}{t_{RETRY} + t_{BLANK}} = 211mW$$

where  $V_{IN} = 4.5V$ ,  $I_{OUT} = 750mA$ ,  $t_{BLANK} = 14ms$ , and  $t_{RETRY} = 210ms$ .

Attention must be given to the MAX4772 where the latch-off condition must be manually reset by toggling ON from high to low. If the latch-off time duration is not sufficiently high, it is possible for the device to reach the thermal-shutdown threshold and never be able to turn the device on until it cools down.

### Chip Information

TRANSISTOR COUNT: 2539

PROCESS: BiCMOS

# 200mA/500mA Selectable Current-Limit Switches

## Package Information

(The package drawing(s) in this data sheet may not reflect the most current specifications. For the latest package outline information, go to [www.maxim-ic.com/packages](http://www.maxim-ic.com/packages).)

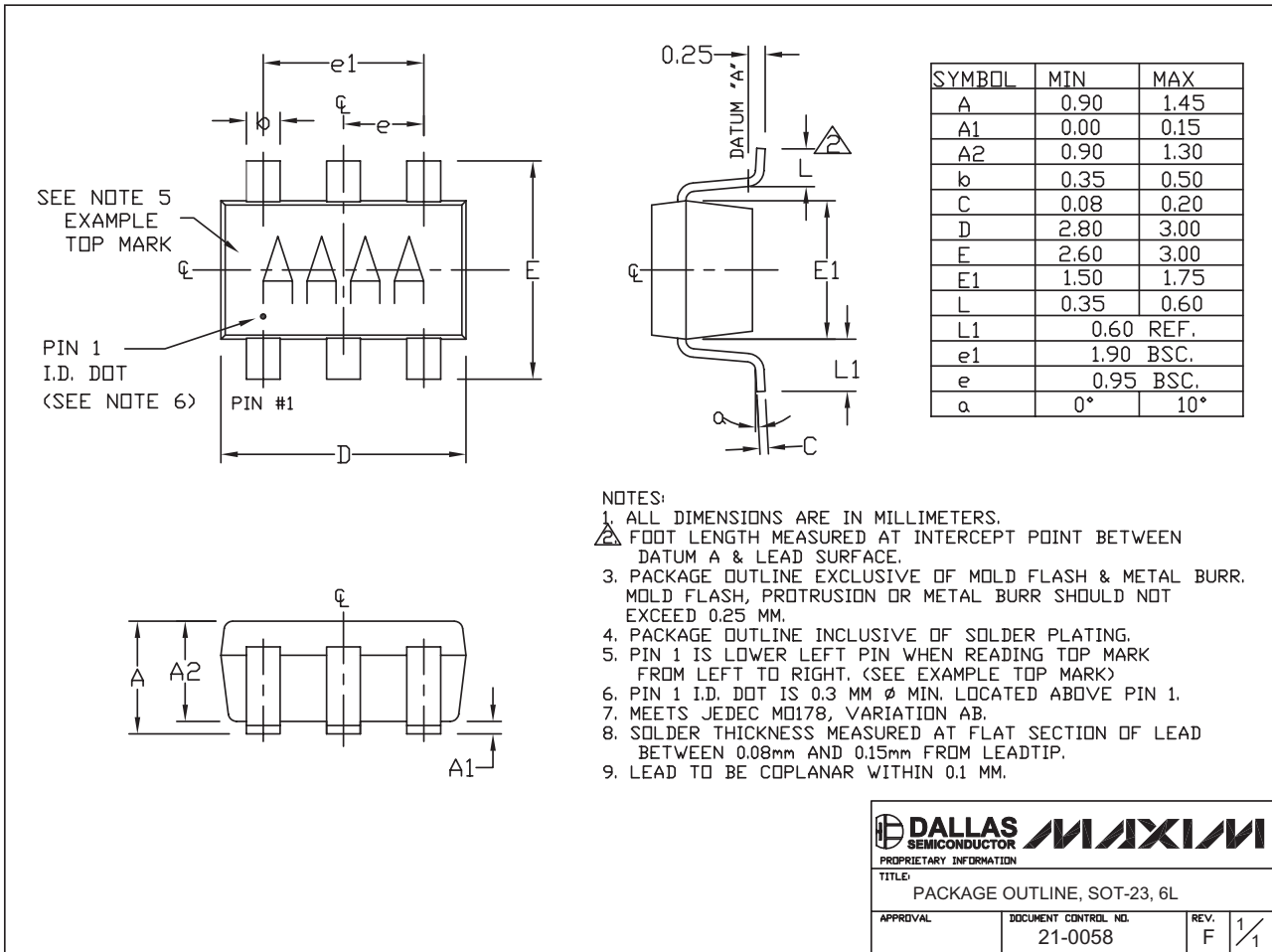

Maxim cannot assume responsibility for use of any circuitry other than circuitry entirely embodied in a Maxim product. No circuit patent licenses are implied. Maxim reserves the right to change the circuitry and specifications without notice at any time.

10 \_\_\_\_\_ **Maxim Integrated Products, 120 San Gabriel Drive, Sunnyvale, CA 94086 408-737-7600**

## Looking for pricing, stock, or lifecycle information?

Click below to explore more details on WIN SOURCE:

 [View MAX4772EUT+T on WIN SOURCE](#)

 [Maxim Integrated](#) Information

## Optimize Your Supply Chain with WIN SOURCE Solutions

-  Global Sourcing Solution
-  Obsolete Management
-  Cost Control Management
-  Shortage Management
-  Alternative Solution
-  Excess Inventory Management