



**THE DATASHEET OF  
MAX2659ELT+TG47**



Click [here](#) to ask about the production status of specific part numbers.

## MAX2659

## GPS/GNSS Low-Noise Amplifier

### General Description

The MAX2659 high-gain, low-noise amplifier (LNA) is designed for GPS, Galileo, and GLONASS applications. Designed in Maxim's advanced SiGe process, the device achieves a 20.5dB gain and an ultra-low-noise figure of 0.8dB while maximizing the input-referred 1dB compression point and the 3rd-order intercept point at -12dBm and -5dBm, respectively.

The MAX2659 operates from a +1.6V to +3.6V single supply and consumes only 4.1mA. The shutdown feature in the device reduces the supply current to be less than 1 $\mu$ A. The MAX2659 is available in a very small, lead-free, RoHS-compliant, 1.5mm x 1.0mm x 0.75mm, 6-pin  $\mu$ DFN package.

### Applications

- Automotive Navigation
- Location-Enabled Mobile Devices
- Telematics (Asset Tracking and Management)
- Personal Navigation Device (PND)
- Cellular Phones with GPS
- Notebook PC/Ultra-Mobile PC
- Recreational, Marine Navigation
- Avionics

### Benefits and Features

- Improves System Performance
  - Ultra-Low 0.8dB Noise Figure
  - High-Power 20.5dB Gain
  - Wide 1.6V to 3.6V Supply Range
- Lowers System Cost With Low Bill of Materials and Small Size
  - Integrated 50 $\Omega$  Output Matching Circuit
  - Small 1.5mm x 1.0mm Footprint
  - Thin 0.75mm Profile
- Reduces Power Consumption
  - Low 4.1mA Supply Current
  - Power-Shutdown Control Mode to Eliminate the Need for External Supply Switch
- AEC-Q100 (MAX2659ELT/V+ Only)
- $\pm$ 2500V ESD HBM (Human Body Model)

### Ordering Information

PART	TEMP RANGE	PIN-PACKAGE
MAX2659ELT+	-40°C to +85°C	6 $\mu$ DFN
MAX2659ELT/V+	-40°C to +85°C	6 $\mu$ DFN

+Denotes lead(Pb)-free/RoHS-compliant package.  
/V denotes an automotive qualified part.

### Pin Configuration/Functional Diagram/Typical Application Circuit

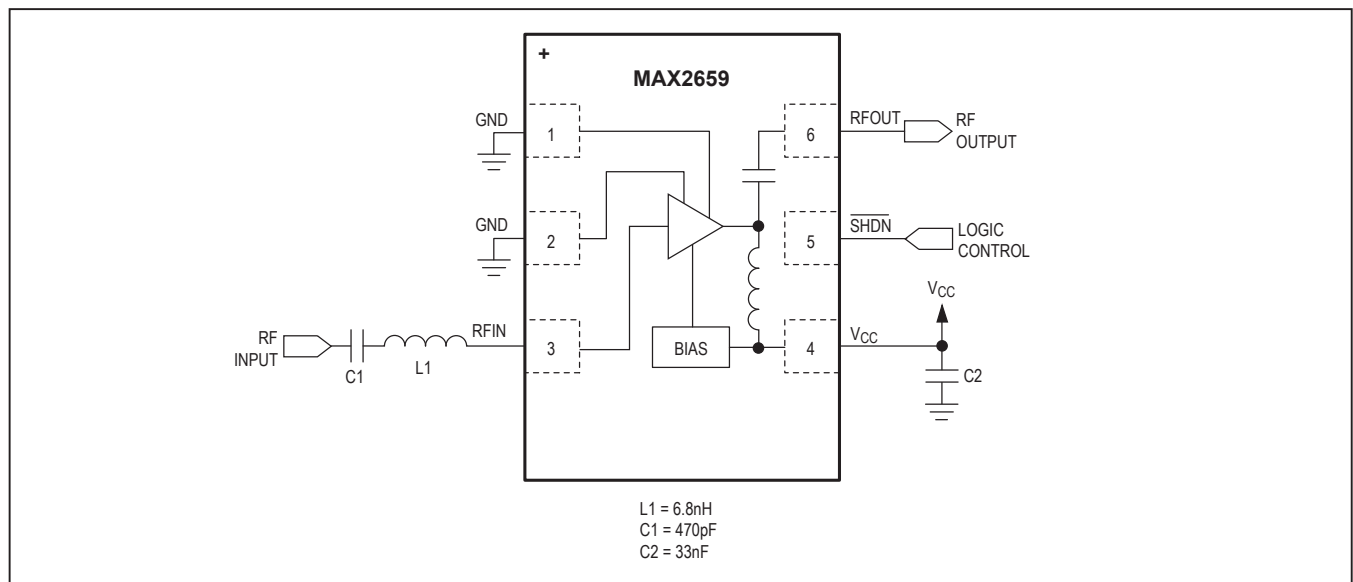

### Absolute Maximum Ratings

V<sub>CC</sub> to GND .....-0.3V to +4.2V  
 Other Pins to GND  
     Except RFIN .....-0.3V to (+ Operating V<sub>CC</sub> + 0.3V)  
 RFIN to GND .....+1V  
 Maximum RF Input Power.....+10dBm  
 Continuous Power Dissipation (T<sub>A</sub> = +70°C)  
     6-Pin µDFN (derates 2.1mW/°C above +70°C)..... 167mW

Operating Temperature Range..... -40°C to +85°C  
 Junction Temperature..... +150°C  
 Storage Temperature Range..... -65°C to +160°C  
 Lead Temperature (soldering, 10s) .....+260°C  
 Soldering Temperature (reflow)..... +260°C

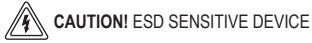

*Stresses beyond those listed under "Absolute Maximum Ratings" may cause permanent damage to the device. These are stress ratings only, and functional operation of the device at these or any other conditions beyond those indicated in the operational sections of the specifications is not implied. Exposure to absolute maximum rating conditions for extended periods may affect device reliability.*

### Package Information

#### 6 µDFN

PACKAGE CODE	L611+2
Outline Number	<a href="#">21-0147</a>
Land Pattern Number	<a href="#">90-0084</a>
<b>Thermal Resistance, Four-Layer Board:</b>	
Junction to Ambient (θ <sub>JA</sub> )	477°C/W
Junction to Case (θ <sub>JC</sub> )	122°C/W

For the latest package outline information and land patterns (footprints), go to [www.maximintegrated.com/packages](http://www.maximintegrated.com/packages). Note that a "+", "#", or "-" in the package code indicates RoHS status only. Package drawings may show a different suffix character, but the drawing pertains to the package regardless of RoHS status.

Package thermal resistances were obtained using the method described in JEDEC specification JESD51-7, using a four-layer board. For detailed information on package thermal considerations, refer to [www.maximintegrated.com/thermal-tutorial](http://www.maximintegrated.com/thermal-tutorial).

## DC Electrical Characteristics

(MAX2659 EV kit;  $V_{CC} = 1.6V$  to  $3.6V$ ,  $T_A = -40^{\circ}C$  to  $+85^{\circ}C$ , no RF signals are applied. Typical values are at  $V_{CC} = 2.85V$  and  $T_A = +25^{\circ}C$ , unless otherwise noted.) (Note 1)

PARAMETER	CONDITIONS		MIN	TYP	MAX	UNITS
Supply Voltage			1.6	2.85	3.6	V
Supply Current	$\overline{SHDN} = \text{high}$			4.1	5.6	mA
	$\overline{SHDN} = \text{high}@105^{\circ}C$				6.2	
	Shutdown mode, $\overline{SHDN} = \text{low}$ ( $-40^{\circ}C$ to $105^{\circ}C$ )				1	$\mu A$
Digital Input-Logic High	$(-40^{\circ}C$ to $105^{\circ}C)$		1.1			V
Digital Input-Logic Low	$(-40^{\circ}C$ to $105^{\circ}C)$				0.4	V
Digital Input Current	$(-40^{\circ}C$ to $105^{\circ}C)$				1	$\mu A$
RFIN DC Voltage	$\overline{SHDN} = \text{high}$			0.83		V
ESD Protection	HBM	JEDEC/HBM		$\pm 2500$		V
		JESD22-A114				

## AC Electrical Characteristics

(MAX2659 EV kit;  $V_{CC} = 1.6V$  to  $3.6V$ ,  $T_A = -40^{\circ}C$  to  $+85^{\circ}C$ ,  $f_{RFIN} = 1575.42MHz$ . Typical values are at  $V_{CC} = 2.85V$  and  $T_A = +25^{\circ}C$ , unless otherwise noted.) (Note 1)

PARAMETER	CONDITIONS		MIN	TYP	MAX	UNITS
RF Frequency	L1 band			1575.42		MHz
Power Gain	$V_{CC} = 2.85V$		17	20.5		dB
	$V_{CC} = 2.85V@105^{\circ}C$		15			
	$V_{CC} = 1.6V$		16.5	20.5		
	$V_{CC} = 1.6V@105^{\circ}C$		14			
Noise Figure	(Note 2)			0.8		dB
3rd-Order Input Intercept Point	(Note 3)			-5		dBm
Input 1dB Compression point	(Note 4)			-12		dBm
Input Return Loss	(Note 2)		10	15		dB
Output Return Loss	(Note 2)		10	25		dB
Reverse Isolation	(Note 2)			32		dB

**Note 1:** Min and Max limits guaranteed by test at  $T_A = +25^{\circ}C$  and guaranteed by design and characterization at  $T_A = -40^{\circ}C$  and  $T_A = +85^{\circ}C$ , unless otherwise specified.

**Note 2:** Guaranteed by design and characterization.

**Note 3:** Measured with the two tones located at 5MHz and 10MHz offset from the center of the GPS band with -40dBm/tone.

**Note 4:** Measured with a tone located at 5MHz offset from the center of the GPS band.

Typical Operating Characteristics

(MAX2659 EV kit; Typical values are at  $V_{CC} = 2.85V$ ,  $T_A = +25^\circ C$ , and  $f_{RFIN} = 1575.42MHz$ , unless otherwise noted.)

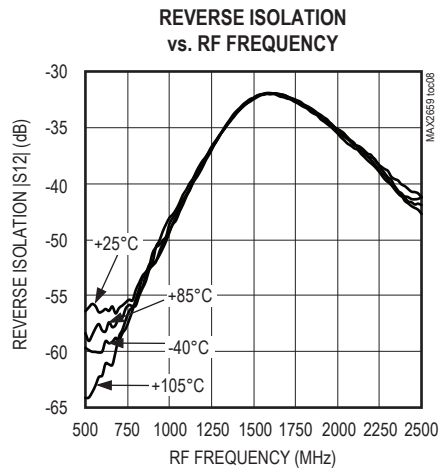
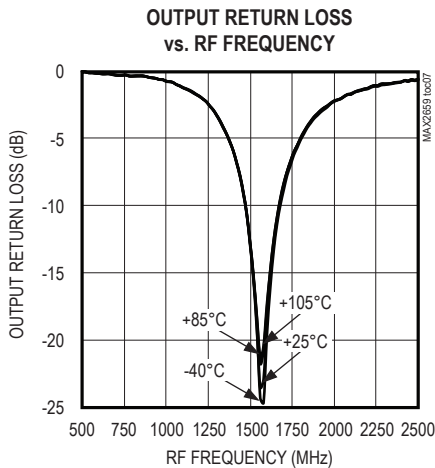
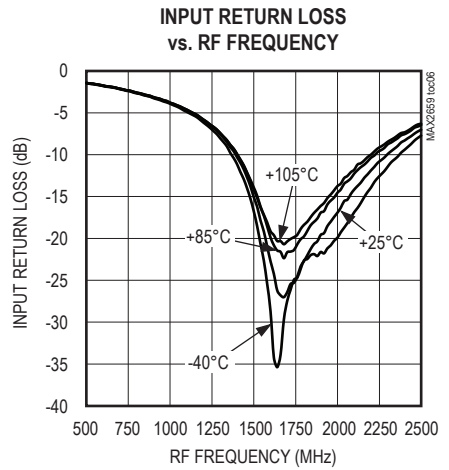
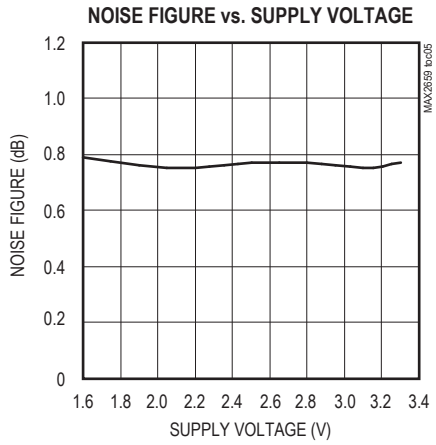
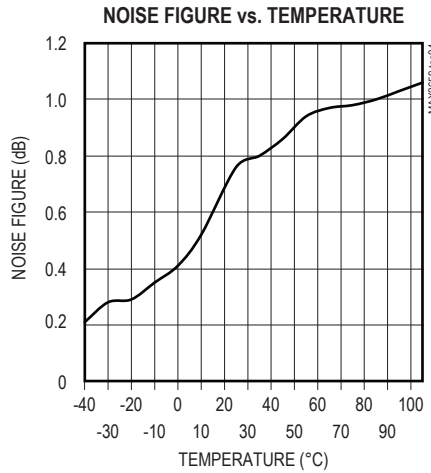
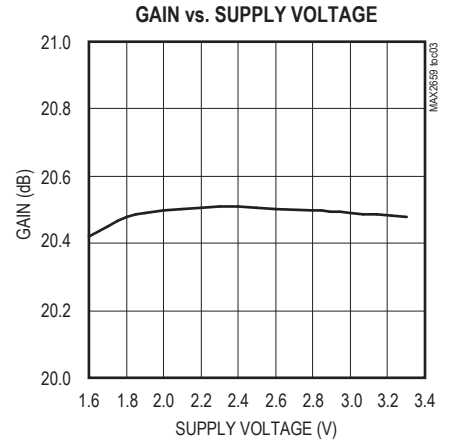
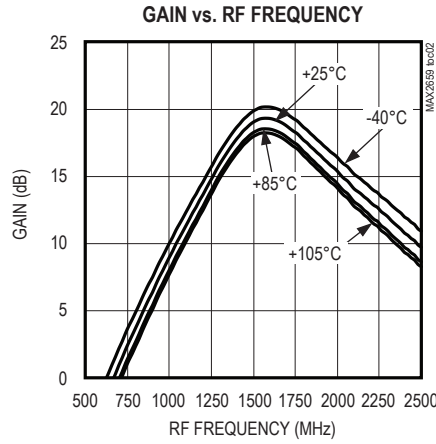
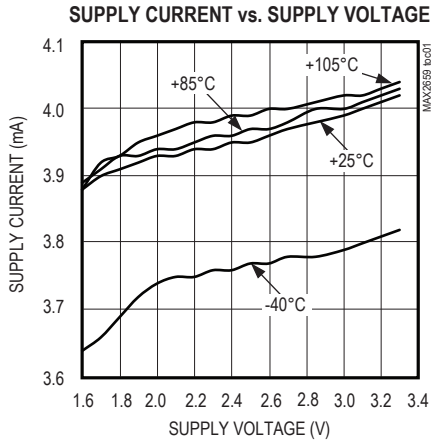

Typical Operating Characteristics (continued)

(MAX2659 EV kit; Typical values are at  $V_{CC} = 2.85V$ ,  $T_A = +25^{\circ}C$ , and  $f_{RFIN} = 1575.42MHz$ , unless otherwise noted.)

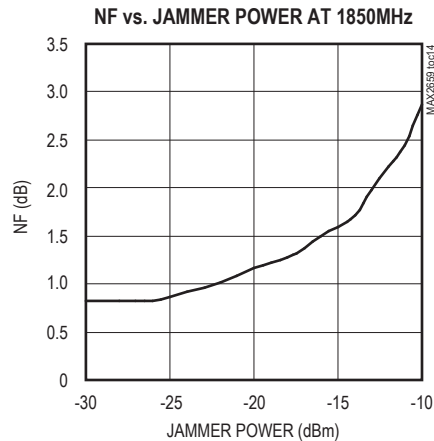
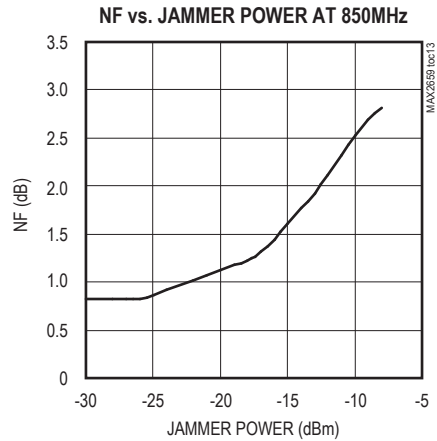
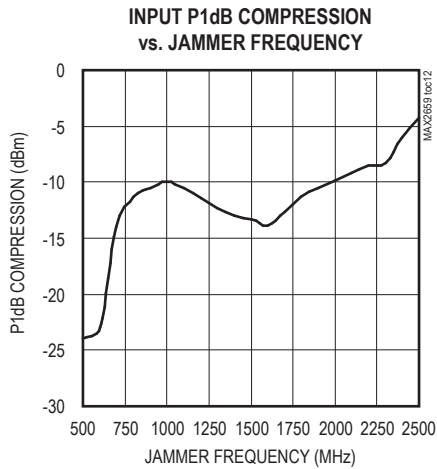
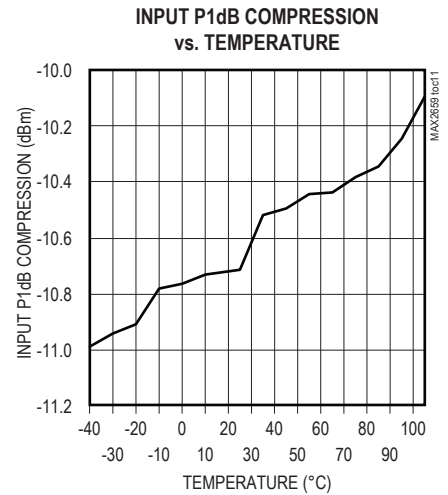
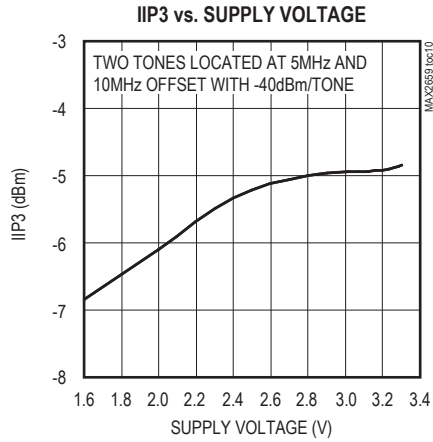
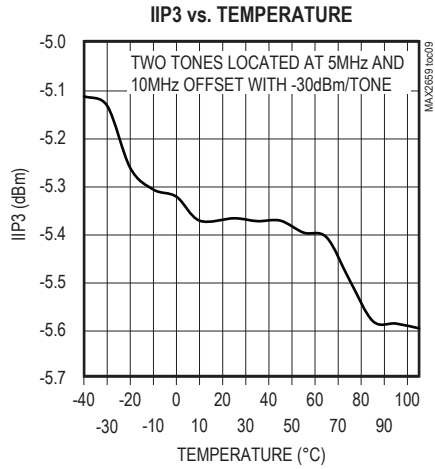

## Pin Description

PIN	NAME	FUNCTION
1, 2	GND	Ground. Connect to the PCB ground plane.
3	RFIN	RF Input. Requires a DC-blocking capacitor and external matching components.
4	V <sub>CC</sub>	Supply Voltage. Bypass to ground with a 33nF capacitor as close as possible to the IC.
5	$\overline{\text{SHDN}}$	Shutdown Input. A logic-low disables the device.
6	RFOUT	RF Output. RFOUT is internally matched to 50Ω and incorporates an internal DC-blocking capacitor.

## Detailed Description

The MAX2659 is an LNA designed for GPS L1, GALILEO, and GLONASS applications. The device features a power-shutdown control mode to eliminate the need for an external supply switch. The device achieves a 20.5dB gain and an ultra-low-noise figure of 0.8dB. The MAX2659 consumes approximately 4.1mA while providing a IP<sub>1dB</sub> of -12dBm and an IIP<sub>3</sub> of -5dBm.

### Input and Output Matching

The MAX2659 requires an off-chip input matching. Only a 6.8nH inductor in series with a DC-blocking capacitor is need-

ed to form the input matching circuit. The *Typical Application Circuit* diagram shows the recommended input-matching network. These values are optimized for the best simultaneous gain, noise figure, and return loss performance. Table 1 lists typical device S<sub>11</sub> values. The MAX2659 integrates an on-chip output matching to 50Ω at the output, eliminating the need for external matching components.

### Shutdown

The MAX2659 includes a shutdown feature to turn off the entire chip. Apply a logic high to  $\overline{\text{SHDN}}$  pin to place the part in the active mode and a logic low to place the part in the shutdown mode.

**Table 1. Typical S<sub>11</sub> Values**

FREQUENCY (MHz)	REAL S <sub>11</sub>	IMAGINARY S <sub>11</sub>
1000	-0.58	-j0.52
1100	-0.68	-j0.356
1200	-0.74	-j0.16
1300	-0.74	j0.036
1400	-0.676	j0.22
1500	-0.56	j0.36
1575	-0.47	j0.415
1600	-0.44	j0.43
1700	-0.36	j0.467
1800	-0.3	j0.51
1900	-0.228	j0.567
2000	-0.14	j0.622

## Applications Information

A properly designed PC board (PCB) is essential to any RF microwave circuit. Use controlled-impedance lines on all high-frequency inputs and outputs. Bypass V<sub>CC</sub> with decoupling capacitors located close to the device. For long V<sub>CC</sub> lines, it may be necessary to add decoupling capacitors. Locate these additional capacitors further away from the device package. Proper grounding of the GND pins is essential. If the PCB uses a topside RF ground, connect it directly to the GND pins. For a board where the ground is not on the component layer, connect the GND pins to the board with multiple vias close to the package.

The MAX2659 can be matched to several GPS/GNSS bands by adding additional external components. See Table 2 for matching values and Tables 3–5 for measured performance. Figures 1 and 2 show the placement of the additional components.



### Linearity Performance

It is possible to improve the device's IP3. Accomplish this by adding an inductor between pin 2 and ground. While this addition increases IP3, gain decreases and noise figure increases.

**Table 6. Linearity Performance (Tone 1 = 1713.42MHz at -17dBm, Tone 2 = 1851.42MHz at -59dBm)**

DEGENERATION INDUCTOR	ICC (mA)	GAIN (dB)	NF (dB)	IP1dB (dBm)	IIP3 (dBm)
0.9nH	4.0	18.4	1.0	-7.0	6.2
None	4.1	20.5	0.8	-12	-0.5

### Chip Information

PROCESS: SiGe BiCMOS

## Revision History

REVISION NUMBER	REVISION DATE	DESCRIPTION	PAGES CHANGED
0	4/07	Initial release	—
1	5/08	Updated Digital Input-Logic High specification and added RFIN DC Voltage specification in <i>DC Electrical Characteristics</i> table	2
2	9/09	Added MAX2659ELT/V+ to <i>Ordering Information</i>	1
3	1/11	Updated maximum supply voltage specification to 3.6V	1, 2
4	8/11	Updated <i>Absolute Maximum Ratings</i> to reflect correct RFIN voltage	2
5	5/15	Updated <i>Benefits and Features</i> section	1
6	9/17	Added AEC statement to Features section	1
7	5/18	Added <i>Package Information</i> section	2
8	2/20	Updated <i>Applications Information</i> section, added Figures 1–3, and Tables 2–6	6–8
9	1/21	Updated <i>Package Information</i> section, DC and AC <i>Electrical Characteristics</i> table, and <i>Typical Operating Characteristics</i> . Removed repeated accounts of <i>package information</i>	2–5, 8
10	6/21	Updated <i>Benefits and Features</i> section and <i>DC Electrical Characteristics</i> table	1, 3

For pricing, delivery, and ordering information, please visit Maxim Integrated's online storefront at <https://www.maximintegrated.com/en/storefront/storefront.html>.

Maxim Integrated cannot assume responsibility for use of any circuitry other than circuitry entirely embodied in a Maxim Integrated product. No circuit patent licenses are implied. Maxim Integrated reserves the right to change the circuitry and specifications without notice at any time. The parametric values (min and max limits) shown in the *Electrical Characteristics* table are guaranteed. Other parametric values quoted in this data sheet are provided for guidance.

## Looking for pricing, stock, or lifecycle information?

Click below to explore more details on WIN SOURCE:

- ⊖ [View MAX2659ELT+TG47 on WIN SOURCE](#)
- ⊖ [Maxim Integrated Information](#)

## Optimize Your Supply Chain with WIN SOURCE Solutions

- ✓ Global Sourcing Solution
- ✓ Obsolete Management
- ✓ Cost Control Management
- ✓ Shortage Management
- ✓ Alternative Solution
- ✓ Excess Inventory Management