



# THE DATASHEET OF VUM85-05A



# Rectifier Module for Three Phase Power Factor Correction

$V_{DSS} = 500 \text{ V}$   
 $I_{D25} = 130 \text{ A}$   
 $R_{DS(on)} = 36 \text{ m}\Omega$

Preliminary data

$V_{RRM}$ (FAST Diode) V	$V_{RRM, DRM}$ (Diode, Thyr.) V	$V_{DSS}$ (MOSFET) V	Type
600	500	500	VUM 85-05A

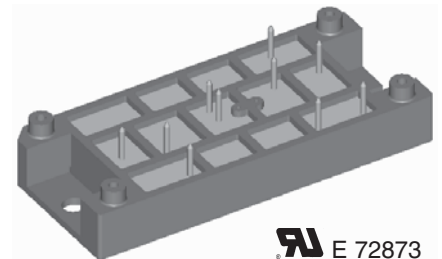
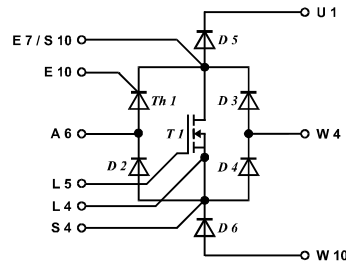

Symbol	Conditions	Maximum Ratings	
<b>MOSFET T 1</b>			
$V_{DSS}$	$T_{VJ} = 25^\circ\text{C}$ to $150^\circ\text{C}$	500	V
$V_{DGR}$	$T_{VJ} = 25^\circ\text{C}$ to $150^\circ\text{C}$ ; $R_G = 1 \text{ M}\Omega$	500	V
$V_{GSM}$	Transient	$\pm 30$	V
$V_{GS}$	Continuous	$\pm 20$	V
$I_D$	$T_C = 100^\circ\text{C}$ , $T_{VJ} = 125^\circ\text{C}$	60	A
$I_{D25}$	$T_C = 25^\circ\text{C}$ , $T_{VJ} = 150^\circ\text{C}$	130	A
$I_{DM}$	$T_C = 25^\circ\text{C}$ , $T_{VJ} = 150^\circ\text{C}$	520	A
$E_{AR}$	$T_C = 25^\circ\text{C}$	60	mJ
$P_{tot}$	$T_C = 25^\circ\text{C}$	1380	W
<b>Single Phase Bridge Th1, D2, D3, D4</b>			
$V_{RRM}, V_{DRM}$		500	V
$I_{DAV}$	$T_{VJ} = 150^\circ\text{C}$ , $T_C = 100^\circ\text{C}$	47	A
$I_{FSM}, I_{TSM}$	$T_{VJ} = 45^\circ\text{C}$ , $t = 10 \text{ ms}$ (50 Hz)	320	A
	$t = 8.3 \text{ ms}$ (60 Hz)	340	A
	$T_{VJ} = 150^\circ\text{C}$ , $t = 10 \text{ ms}$ (50 Hz)	280	A
	$t = 8.3 \text{ ms}$ (60 Hz)	300	A
$P_{tot}$	$T_C = 25^\circ\text{C}$ ; per diode	90	W
<b>Fast Diodes D5, D6</b>			
$V_{RRM}$		600	V
$I_{FAV}$	$T_{VJ} = 150^\circ\text{C}$ , $T_C = 100^\circ\text{C}$ , rectangular $\delta = 0.5$	31	A
$I_{FSM}$	$T_{VJ} = 45^\circ\text{C}$ , $t = 10 \text{ ms}$ (50 Hz)	250	A
$P_{tot}$	$T_C = 25^\circ\text{C}$	95	W
<b>Module</b>			
$T_{VJ}$		-40...+150	$^\circ\text{C}$
$T_{JM}$		150	$^\circ\text{C}$
$T_{stg}$		-40...+125	$^\circ\text{C}$
$V_{ISOL}$	$I_{ISOL} \leq 1 \text{ mA}$	50/60 Hz	3600 V~
$M_d$	Mounting torque (M5)		2-2.5/18-22 Nm/lb.in.
<b>Weight</b>		80	g

## Features

- Package with DCB ceramic base plate
- Soldering connections for PCB mounting
- Isolation voltage 3600 V~
- Low  $R_{DS(on)}$  HDMOS™ process
- Low package inductance for high speed switching
- Ultrafast diodes
- Kelvin source for easy drive
- UL recognized

## Applications

- Three phase PFC by Kolar circuit
- Three phase input rectifier with power factor correction consisting of three modules VUM 85-05
- For power supplies, UPS, SMPS, drives, welding etc.

## Advantages

- Reduced harmonic content of input currents corresponding to standards
- Rectifier generates maximum DC power with a given AC fuse
- Wide input voltage range
- No external isolation
- Easy to mount with two screws
- Suitable for wave soldering
- High temperature and power cycling capability

Symbol	Conditions	Characteristic Values		
		(T <sub>VJ</sub> = 25°C, unless otherwise specified)		
		min.	typ.	max.
<b>MOSFET T 1</b>				
V <sub>GS(th)</sub>	V <sub>DS</sub> = ±20 V, I <sub>D</sub> = 30 mA	2	3	4 V
I <sub>GSS</sub>	V <sub>GS</sub> = ±20 V, V <sub>DS</sub> = 0 V			±1.5 μA
I <sub>DSS</sub>	V <sub>DS</sub> = V <sub>DSS</sub> , V <sub>GS</sub> = 0 V V <sub>DS</sub> = 0,8•V <sub>DSS</sub> , V <sub>GS</sub> = 0 V, T <sub>VJ</sub> = 125°C		0.5 1	1.4 7 mA
R <sub>DS(on)</sub>	I <sub>D</sub> = 1/2 I <sub>D25</sub> , V <sub>GS</sub> = 10 V, pulse test t ≤ 300 μs, d ≤ 2%			36 mΩ
g <sub>fs</sub>	V <sub>DS</sub> = 10 V, I <sub>D</sub> = 1/2 I <sub>D25</sub> , t = < 300 μs	75	145	S
t <sub>d(on)</sub>	V <sub>DS</sub> = 1/2 V <sub>DSS</sub> , I <sub>D</sub> = 1/2 I <sub>D25</sub> , V <sub>GS</sub> = 15 V R <sub>G</sub> = 1 Ω, L = 100 μH, T <sub>VJ</sub> = 125°C		16	25 ns
t <sub>r</sub>			33	45 ns
t <sub>d(off)</sub>			65	80 ns
t <sub>f</sub>			30	40 ns
C <sub>iss</sub>	V <sub>DS</sub> = 25 V, f = 1 MHz, V <sub>GS</sub> = 0 V		30	nF
C <sub>oss</sub>			3	nF
C <sub>rss</sub>			1	nF
Q <sub>g(on)</sub>	V <sub>DS</sub> = 1/2 V <sub>DSS</sub> , I <sub>D</sub> = 1/2 I <sub>D25</sub> , V <sub>GS</sub> = 10 V		945	1120 nC
Q <sub>gs</sub>			195	280 nC
Q <sub>gd</sub>			435	595 nC
R <sub>thJC</sub>			0.05	0.09 K/W
R <sub>thCH</sub>				K/W
<b>Single Phase Bridge Th1, D2, D3, D4</b>				
V <sub>F</sub> , V <sub>T</sub>	I <sub>F</sub> , I <sub>T</sub> = 45 A, T <sub>VJ</sub> = 25°C T <sub>VJ</sub> = 125°C			1.50 V 1.55 V
I <sub>RRM</sub> , I <sub>DRM</sub>	V <sub>D</sub> , V <sub>R</sub> = V <sub>DRM</sub> , V <sub>RRM</sub> , T <sub>VJ</sub> = 25°C V <sub>D</sub> , V <sub>R</sub> = 0,8•V <sub>DRM</sub> , V <sub>RRM</sub> , T <sub>VJ</sub> = 125°C		0.5 1	1.4 7 mA
V <sub>T0</sub>	For power-loss calculations only			0.85 V
r <sub>T</sub>	T <sub>VJ</sub> = 150°C			14 mΩ
V <sub>GT</sub>	V <sub>D</sub> = 6 V			1.5 V
I <sub>GT</sub>				100 mA
V <sub>GD</sub>	V <sub>D</sub> = 2/3 V <sub>DRM</sub> , T <sub>VJ</sub> = 150°C			0.2 V
I <sub>GD</sub>				5 mA
V <sub>RGM</sub>				10 V
I <sub>H</sub>	V <sub>D</sub> = 6 V, R <sub>GK</sub> = ∞			200 mA
I <sub>L</sub>	I <sub>G</sub> = 0.45 A, di <sub>G</sub> /dt = 0.45 A/μs, t <sub>p</sub> = 10 μs			450 mA
(di/dt) <sub>cr</sub>	I <sub>G</sub> = 0.45A, di <sub>G</sub> /dt = 0.45A/μs, t <sub>p</sub> = 200μs, f = 50Hz V <sub>D</sub> = 2/3 V <sub>DRM</sub> , T <sub>VJ</sub> = 150°C, I <sub>T</sub> = 45 A, repetitive			150 A/μs
	I <sub>G</sub> = 0.45A, di <sub>G</sub> /dt = 0.45A/μs, t <sub>p</sub> = 200μs, f = 50Hz V <sub>D</sub> = 2/3 V <sub>DRM</sub> , T <sub>VJ</sub> = 150°C, I <sub>T</sub> = I <sub>DAV</sub> , non-repetitive			500 A/μs
t <sub>gd</sub>	I <sub>G</sub> = 0.45 A, di <sub>G</sub> /dt = 0.45 A/μs, V <sub>D</sub> = 1/2 V <sub>DRM</sub>			2 μs
t <sub>q</sub>	I <sub>T</sub> = 20 A, di/dt = -10 A/μs, V <sub>R</sub> = 100 V, V <sub>D</sub> = 2/3 V <sub>DRM</sub> t <sub>p</sub> = 200 μs, dv/dt = 15 V/μs, T <sub>VJ</sub> = 150°C		150	μs
P <sub>GM</sub>	I <sub>T</sub> = I <sub>d(AV)</sub> , T <sub>VJ</sub> = 150°C		t <sub>p</sub> = 30 μs t <sub>p</sub> = 300 μs	10 W 5 W
P <sub>GAVM</sub>				0,5 W
R <sub>thJC</sub>	DC per diode/ thyristor			1.3 K/W
R <sub>thCH</sub>	DC per diode/ thyristor		0.4	K/W

Symbol	Conditions	Characteristic Values		
		(T <sub>VJ</sub> = 25°C, unless otherwise specified)		
		min.	typ.	max.
<b>Fast Diodes D 5, D 6</b>				
V <sub>F</sub>	I <sub>F</sub> = 30 A; T <sub>VJ</sub> = 25°C T <sub>VJ</sub> = 125°C			2.70 V 1.85 V
I <sub>R</sub>	V <sub>R</sub> = 600 V, T <sub>VJ</sub> = 25°C T <sub>VJ</sub> = 125°C			0.5 mA 1 mA
V <sub>T0</sub>	For power-loss calculations only			1.23 V
r <sub>T</sub>	T <sub>VJ</sub> = 150°C			9.8 mΩ
I <sub>RM</sub>	I <sub>F</sub> = 50 A; di/dt = 100 A/μs V <sub>R</sub> = 100 V, T <sub>VJ</sub> = 100°C		3	3.5 A
t <sub>rr</sub>	I <sub>F</sub> = 1 A, V <sub>R</sub> = 30 V, di/dt = 200 A/μs		25	30 ns
R <sub>thJC</sub>	DC per diode			1.3 K/W
R <sub>thCH</sub>	DC per diode		0.4	K/W

Dimensions in mm (1 mm = 0.0394")

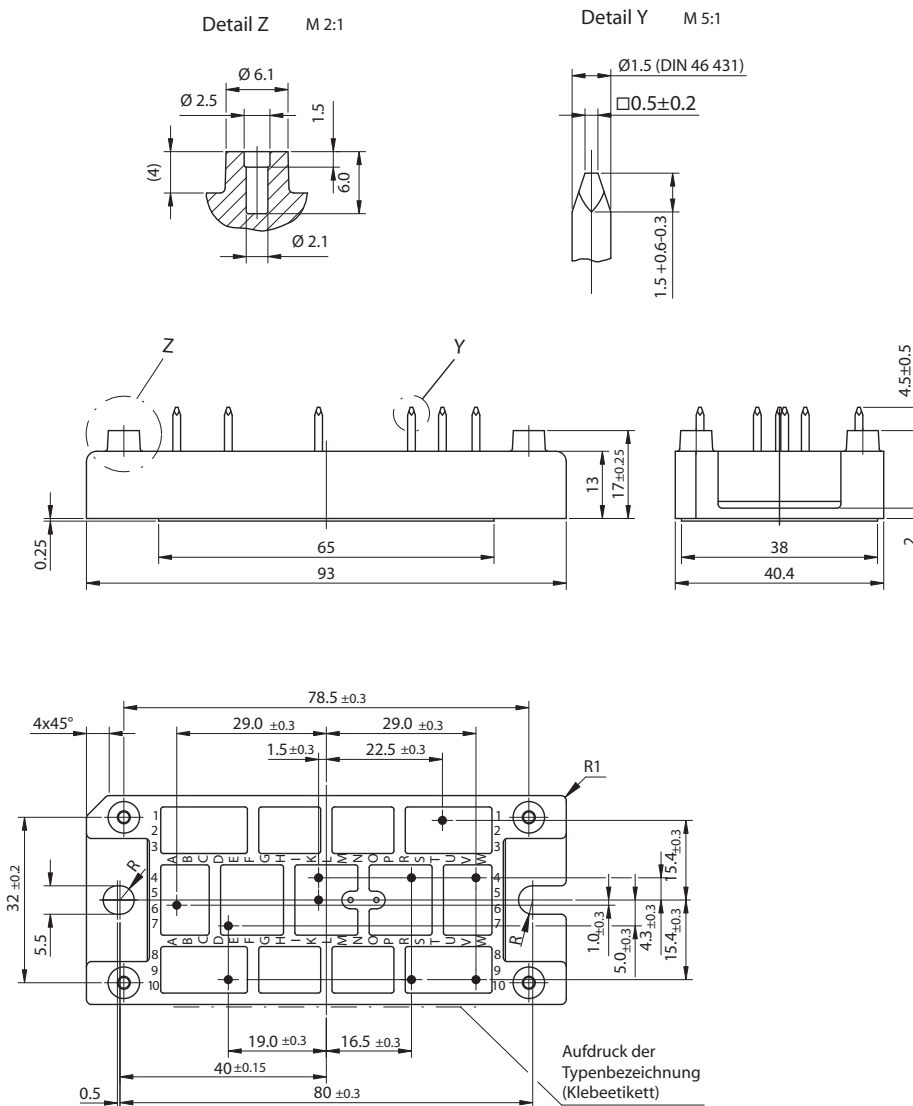





## Looking for pricing, stock, or lifecycle information?

Click below to explore more details on WIN SOURCE:

 [View VUM85-05A on WIN SOURCE](#)

 [IXYS Information](#)

## Optimize Your Supply Chain with WIN SOURCE Solutions

-  Global Sourcing Solution
-  Obsolete Management
-  Cost Control Management
-  Shortage Management
-  Alternative Solution
-  Excess Inventory Management