



# THE DATASHEET OF APA2106SYCK



Part Number: APA2106SYCK

Super Bright Yellow

### Features

- 2.1mmX0.6mm right angle SMT LED, 1.0mm thickness.
- Low power consumption.
- Wide viewing angle.
- Ideal for backlight and indicator.
- Various colors and lens types available.
- Package: 2000pcs / reel.
- Moisture sensitivity level : level 3.
- RoHS compliant.

### Description

The Super Bright Yellow device is made with AlGaInP (on GaAs substrate) light emitting diode chip.

### Package Dimensions

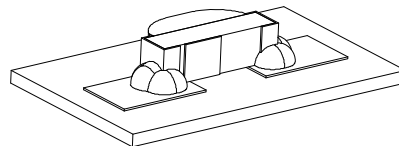
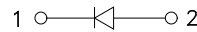
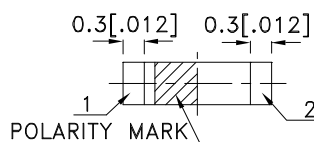
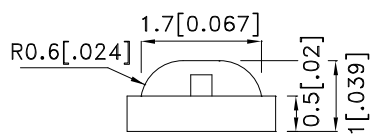
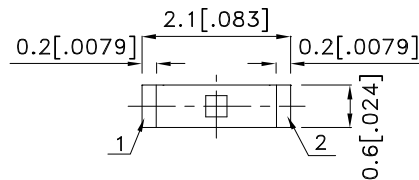

#### Notes:

1. All dimensions are in millimeters (inches).
2. Tolerance is  $\pm 0.1$  (0.004") unless otherwise noted.
3. The specifications, characteristics and technical data described in the datasheet are subject to change without prior notice.
4. The device has a single mounting surface. The device must be mounted according to the specifications



## Selection Guide

Part No.	Dice	Lens Type	Iv (mcd) [2] @ 20mA		Viewing Angle [1]
			Min.	Typ.	2θ1/2
APA2106SYCK	Super Bright Yellow (AlGaInP)	Water Clear	80	150	120°

Notes:

1. θ1/2 is the angle from optical centerline where the luminous intensity is 1/2 of the optical peak value.
2. Luminous intensity/ luminous Flux: +/-15%.
3. Luminous intensity value is traceable to the CIE127-2007 compliant national standards.

## Electrical / Optical Characteristics at TA=25°C

Symbol	Parameter	Device	Typ.	Max.	Units	Test Conditions
λ <sub>peak</sub>	Peak Wavelength	Super Bright Yellow	590		nm	I <sub>F</sub> =20mA
λ <sub>D</sub> [1]	Dominant Wavelength	Super Bright Yellow	590		nm	I <sub>F</sub> =20mA
Δλ <sub>1/2</sub>	Spectral Line Half-width	Super Bright Yellow	20		nm	I <sub>F</sub> =20mA
C	Capacitance	Super Bright Yellow	20		pF	V <sub>F</sub> =0V;f=1MHz
V <sub>F</sub> [2]	Forward Voltage	Super Bright Yellow	2	2.5	V	I <sub>F</sub> =20mA
I <sub>R</sub>	Reverse Current	Super Bright Yellow		10	uA	V <sub>R</sub> =5V

Notes:

- 1.Wavelength: +/-1nm.
- 2.Forward Voltage: +/-0.1V.
- 3.Wavelength value is traceable to the CIE127-2007 compliant national standards.

## Absolute Maximum Ratings at TA=25°C

Parameter	Super Bright Yellow	Units
Power dissipation	75	mW
DC Forward Current	30	mA
Peak Forward Current [1]	175	mA
Reverse Voltage	5	V
Operating Temperature	-40°C To +85°C	
Storage Temperature	-40°C To +85°C	

Note:

1. 1/10 Duty Cycle, 0.1ms Pulse Width.

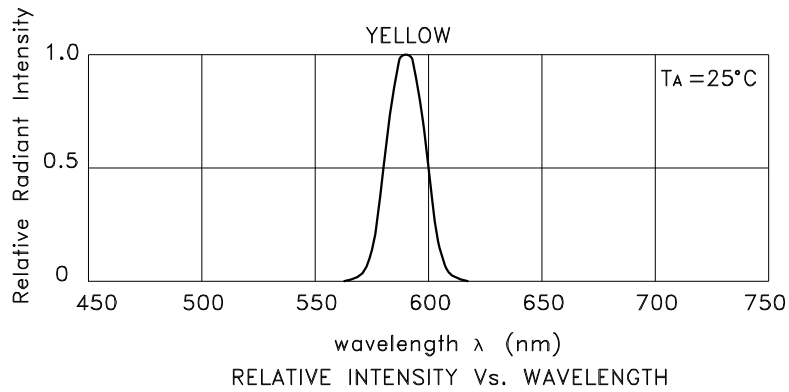

## Super Bright Yellow APA2106SYCK

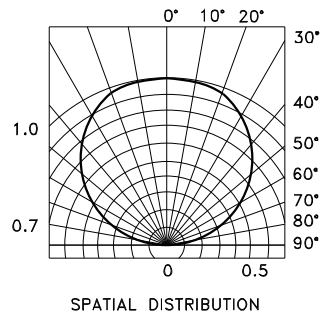
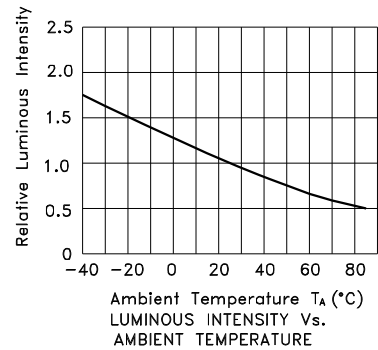
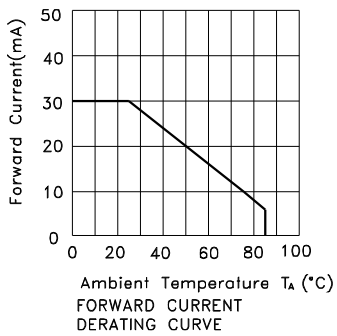
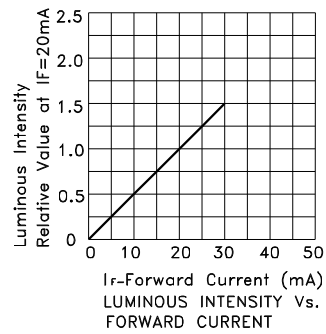
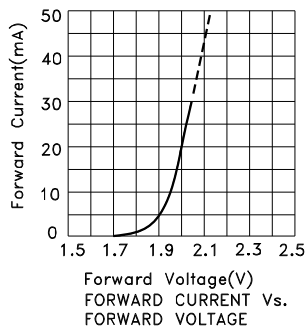

## APA2106SYCK

Reflow soldering is recommended and the soldering profile is shown below.  
Other soldering methods are not recommended as they might cause damage to the product.

Reflow Soldering Profile For Lead-free SMT Process.

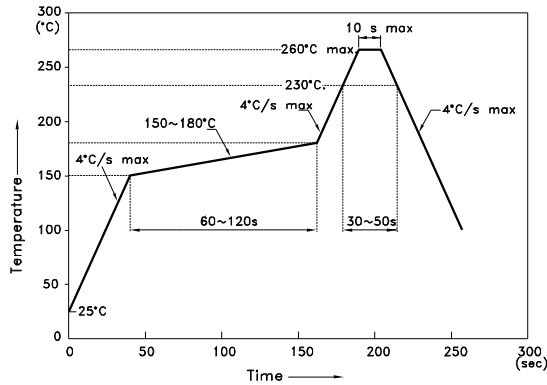

NOTES:

1. We recommend the reflow temperature 245°C (+/-5°C). The maximum soldering temperature should be limited to 260°C.
2. Don't cause stress to the epoxy resin while it is exposed to high temperature.
3. Number of reflow process shall be 2 times or less.

### Recommended Soldering Pattern (Units : mm; Tolerance: ± 0.1)

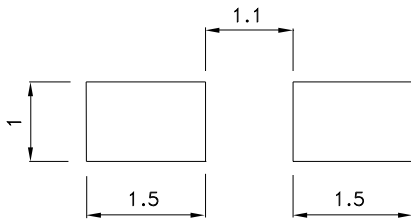

### Reel Dimension

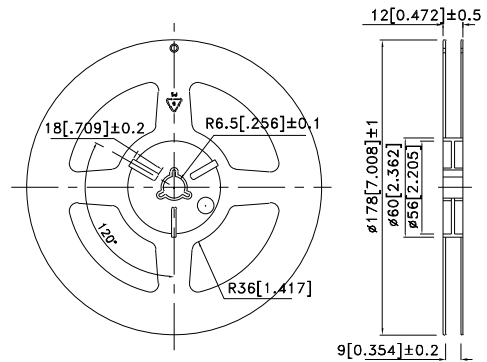

### Tape Dimensions

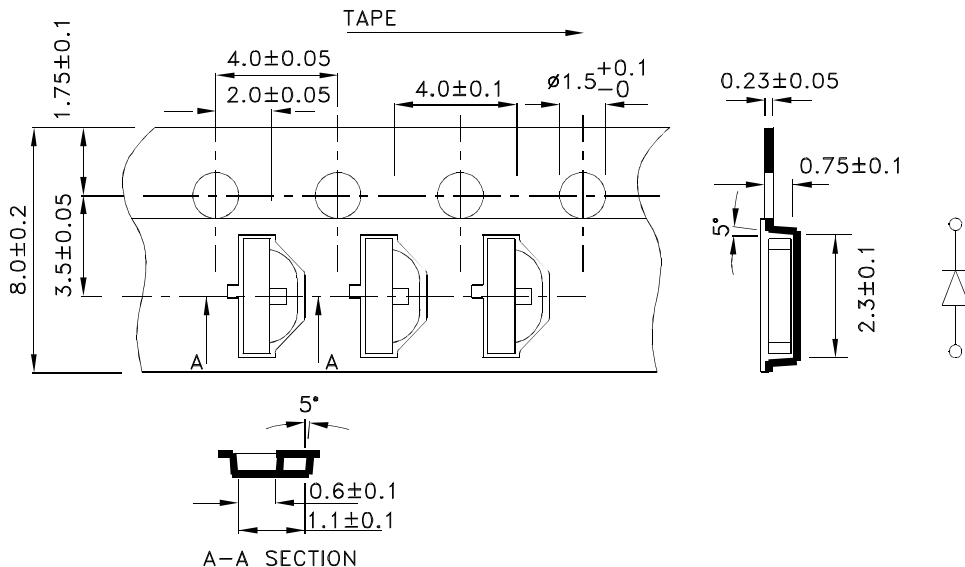

# Kingbright

## PACKING & LABEL SPECIFICATIONS

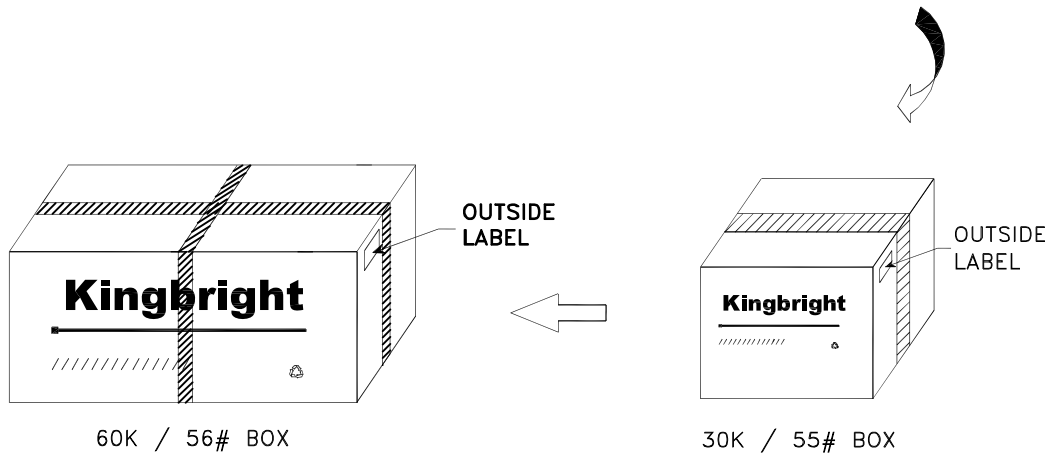
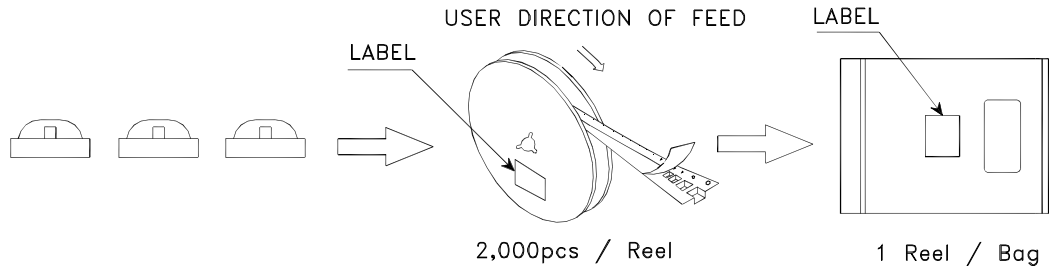

## APA2106SYCK



<h1>Kingbright</h1>				
P/NO: APA2106xxx				
QTY: 2,000 pcs	Q.C.			
S/N: XXXX	<table border="1"> <tr> <td style="text-align: center;">Q C</td> </tr> <tr> <td style="text-align: center;">XX XX XXXX</td> </tr> <tr> <td style="text-align: center;">PASSED</td> </tr> </table>	Q C	XX XX XXXX	PASSED
Q C				
XX XX XXXX				
PASSED				
CODE: XXX				
LOT NO:				
 XXXXXXXXXXXXXXXXXXXXXXXXXXXX				
RoHS Compliant				

## Looking for pricing, stock, or lifecycle information?

Click below to explore more details on WIN SOURCE:

-  [View APA2106SYCK on WIN SOURCE](#)
-  [Kingbright Information](#)

## Optimize Your Supply Chain with WIN SOURCE Solutions

-  Global Sourcing Solution
-  Obsolete Management
-  Cost Control Management
-  Shortage Management
-  Alternative Solution
-  Excess Inventory Management