



THE DATASHEET OF ARD1204H





FEATURES

1. High frequency characteristics (Impedance 50Ω)

Frequency (GHz)	to 1	1 to 4	4 to 8	8 to 12.4	12.4 to 18	18 to 26.5*
V.S.W.R. (max.)	1.1	1.15	1.25	1.35	1.5	1.7
Insertion loss (dB, max.)	0.2		0.3	0.4	0.5	0.8
Isolation (dB, min.)	85	80	70	65	60	55

* 18 to 26.5GHz characteristics can be applied 26.5GHz type only (SPDT, Transfer)

2. SPDT, Transfer and SP6T type is available

3. High sensitivity

Nominal operating power:
840 mW (SPDT/SP6T, Failsafe type)
1,540 mW (Transfer, Failsafe type)

4. Long life: 5×10^6

5. With termination type is available (SP6T)

6. + COM type is available

TYPICAL APPLICATIONS

Wireless and mobile communication

- Cellular phone base stations
- Amplifier switching

Digital broadcasting

- Broadcasting relay station
- Broadcasting equipment

Measurement instruments

- All types of inspection equipment

RoHS Directive compatibility information
<http://www.nais-e.com/>

SPECIFICATIONS

Contact		SPDT	Transfer				
Arrangement							
Contact material		Gold					
Initial contact resistance (By voltage drop 6V DC 1A)		Max. 100mΩ					
Rating	Contact input power* ¹	120W 3GHz (V.S.W.R. 1.15 or less, no contact switching, ambient temperature 40°C [SPDT], 25°C [Transfer], 25°C [SP6T]) ^{#1}					
Indicator rating	Contact rating	Max. 30V 100mA					
	Initial contact resistance (Measured by 5V 100mA)	Max. 1Ω					
High frequency characteristics (Impedance 50Ω)		to 1GHz	1 to 4	4 to 8	8 to 12.4	12.4 to 18	18 to 26.5 ^{#2}
	V.S.W.R. (max.)	1.1	1.15	1.25	1.35	1.5	1.7
	Insertion loss (dB, max.)	0.2		0.3	0.4	0.5	0.8
	Isolation (dB, min.)	85	80	70	65	60	55
Expected life (min. operation)	Mechanical (at 180 cpm)	5×10^6					
	Electrical (at 20 cpm)	5×10^6 (5W, to 3GHz, impedance 50Ω, V.S.W.R.; max. 1.2)					

Arrangement		SP6T				
Contact material		Gold				
Initial contact resistance (By voltage drop 6V DC 1A)		Max. 100mΩ				
Rating	Contact input power* ¹	120W 3GHz (V.S.W.R. 1.15 or less, no contact switching, ambient temperature 40°C [SPDT], 25°C [Transfer], 25°C [SP6T]) ^{#1}				
Indicator rating	Contact rating	Max. 30V 100mA				
	Initial contact resistance (Measured by 5V 100mA)	Max. 1Ω				
High frequency characteristics (Impedance 50Ω)		to 1GHz	1 to 4	4 to 8	8 to 13	
	V.S.W.R. (max.)	1.1	1.15	1.25	1.35	
	Insertion loss (dB, max.)	0.2		0.3	0.4	
	Isolation (dB, min.)	85	80	70	65	
Expected life (min. operation)	Mechanical (at 180 cpm)	5×10^6				
	Electrical (at 20 cpm)	5×10^6 (5W, to 3GHz, impedance 50Ω, V.S.W.R.; max. 1.2)				

#1 Factors such as heating of the connected connector influence the high frequency characteristics; therefore, please verify under actual conditions of use.

#2 18 to 26.5 GHz characteristics apply to the 26.5 GHz type only.

Characteristics

		SPDT	Transfer
Initial insulation resistance*2		Min. 1,000 MΩ (at 500 V DC)	
Initial breakdown voltage*3	Between open contacts	500 Vrms for 1 min.	
	Between contact and coil	500 Vrms for 1 min.	
	Between contact and earth terminal	500 Vrms for 1 min.	
	Between coil and earth terminal	500 Vrms for 1 min.	
Operate time*4 (at 20°C)		Max. 15ms	Max. 20ms
Shock resistance	Functional*5	Min. 500 m/s ²	
	Destructive*6	Min. 1,000 m/s ²	
Vibration resistance	Functional*7	10 to 55 Hz at double amplitude of 3mm	
	Destructive	10 to 55 Hz at double amplitude of 5mm	
Conditions for operation, transport and storage*8 (Not freezing and condensing at low temperature)	Ambient temp	-55°C to +85°C -67°F to +185°F	
	Humidity	5 to 85% R.H.	
Unit weight (Approx.)		50g 1.76oz	110g 3.88oz

		SP6T
Initial insulation resistance*2		Min. 1,000 MΩ (at 500 V DC)
Initial breakdown voltage*3	Between open contacts	500 Vrms for 1 min.
	Between contact and coil	500 Vrms for 1 min.
	Between contact and earth terminal	500 Vrms for 1 min.
	Between coil and earth terminal	500 Vrms for 1 min.
Operate time*4 (at 20°C)		Max. 20ms
Shock resistance	Functional*5	Min. 500 m/s ²
	Destructive*6	Min. 1,000 m/s ²
Vibration resistance	Functional*7	10 to 55 Hz at double amplitude of 3mm
	Destructive	10 to 55 Hz at double amplitude of 5mm
Conditions for operation, transport and storage*8 (Not freezing and condensing at low temperature)	Ambient temp	-55°C to +85°C -67°F to +185°F
	Humidity	5 to 85% R.H.
Unit weight (Approx.)		320g 11.29oz

Remarks

*1 Please verify the usability of input power under actual conditions because heat generated from connectors can influence connection.

*2 Measurement at same location as "Initial breakdown voltage" section.

*3 Detection current: 10mA

*4 Nominal operating voltage applied to the coil, excluding contact bounce time.

*5 Half-wave pulse of sine wave: 11ms, detection time: 10ms.

*6 Half-wave pulse of sine wave: 11ms

*7 Detection time: 10ms

*8 Refer to 4. Conditions for operation, transport and storage conditions in NOTES (Page 42).

ORDERING INFORMATION

Ex. A RD

Product name	Frequency	Operating function	Nominal operating voltage, V DC	Operation terminal	HF data attached
RD	1: to 18GHz (SPDT) 2: to 18GHz (Transfer) 3: to 13GHz (SP6T) 5: to 26.5GHz (SPDT) 6: to 26.5GHz (Transfer)	00: Failsafe 20: Latching 51: Latching with TTL driver (with self cut-off function) (SPDT, Transfer)	4H: 4.5 (Failsafe, Latching type only) 05: 5 (Latching with TTL driver type only) 12: 12 24: 24	Nil: Solder terminal C: Connector cable (SPDT type only)	Nil: No HF test data attached Q: HF test data attached

Note: Sealed types are also available. (SPDT type only)

RD (ARD)

TYPES

1. SPDT

1) Solder terminal

Operating function	Nominal operating voltage, V DC	18GHz type		26.5GHz type	
		No HF datasheet attached	HF datasheet attached	No HF datasheet attached	HF datasheet attached
Failsafe	4.5	ARD1004H	ARD1004HQ	ARD5004H	ARD5004HQ
	12	ARD10012	ARD10012Q	ARD50012	ARD50012Q
	24	ARD10024	ARD10024Q	ARD50024	ARD50024Q
Latching	4.5	ARD1204H	ARD1204HQ	ARD5204H	ARD5204HQ
	12	ARD12012	ARD12012Q	ARD52012	ARD52012Q
	24	ARD12024	ARD12024Q	ARD52024	ARD52024Q
Latching with TTL driver (with self cut-off function)	5	ARD15105	ARD15105Q	ARD55105	ARD55105Q
	12	ARD15112	ARD15112Q	ARD55112	ARD55112Q
	24	ARD15124	ARD15124Q	ARD55124	ARD55124Q

Note: Standard packing; Carton: 1 pc. Case: 20 pcs.

2) Connector cable

Operating function	Nominal operating voltage, V DC	18GHz type		26.5GHz type	
		No HF datasheet attached	HF datasheet attached	No HF datasheet attached	HF datasheet attached
Failsafe	4.5	ARD1004HC	ARD1004HCQ	ARD5004HC	ARD5004HCQ
	12	ARD10012C	ARD10012CQ	ARD50012C	ARD50012CQ
	24	ARD10024C	ARD10024CQ	ARD50024C	ARD50024CQ
Latching	4.5	ARD1204HC	ARD1204HCQ	ARD5204HC	ARD5204HCQ
	12	ARD12012C	ARD12012CQ	ARD52012C	ARD52012CQ
	24	ARD12024C	ARD12024CQ	ARD52024C	ARD52024CQ
Latching with TTL driver (with self cut-off function)	5	ARD15105C	ARD15105CQ	ARD55105C	ARD55105CQ
	12	ARD15112C	ARD15112CQ	ARD55112C	ARD55112CQ
	24	ARD15124C	ARD15124CQ	ARD55124C	ARD55124CQ

Note: Standard packing; Carton: 1 pc. Case: 10 pcs.

2. Transfer

1) Solder terminal

Operating function	Nominal operating voltage, V DC	18GHz type		26.5GHz type	
		No HF datasheet attached	HF datasheet attached	No HF datasheet attached	HF datasheet attached
Failsafe	4.5	ARD2004H	ARD2004HQ	ARD6004H	ARD6004HQ
	12	ARD20012	ARD20012Q	ARD60012	ARD60012Q
	24	ARD20024	ARD20024Q	ARD60024	ARD60024Q
Latching	4.5	ARD2204H	ARD2204HQ	ARD6204H	ARD6204HQ
	12	ARD22012	ARD22012Q	ARD62012	ARD62012Q
	24	ARD22024	ARD22024Q	ARD62024	ARD62024Q
Latching with TTL driver (with self cut-off function)	5	ARD25105	ARD25105Q	ARD65105	ARD65105Q
	12	ARD25112	ARD25112Q	ARD65112	ARD65112Q
	24	ARD25124	ARD25124Q	ARD65124	ARD65124Q

Note: Standard packing; Carton: 1 pc. Case: 10 pcs.

3. SP6T

Operating function	Nominal operating voltage, V DC	13GHz type	
		No HF datasheet attached	HF datasheet attached
Failsafe	4.5	ARD3004H	ARD3004HQ
	12	ARD30012	ARD30012Q
	24	ARD30024	ARD30024Q
Latching	4.5	ARD3204H	ARD3204HQ
	12	ARD32012	ARD32012Q
	24	ARD32024	ARD32024Q

Note: Standard packing; Carton: 1 pc. Case: 5 pcs.

COIL DATA (at 20°C 68°F)**1. SPDT**

1) Failsafe type

Nominal operating voltage, V DC	Nominal operating current, mA (+10%/–15%)	Nominal power consumption, mW
4.5	186.7	840
12	70.0	840
24	40.4	970

2) Latching type

Nominal operating voltage, V DC	Nominal operating current, mA (+10%/–15%)	Nominal power consumption, mW
4.5	155.6	700
12	62.5	750
24	37.5	900

3) Latching with TTL driver type (with self cut-off function)

Nominal operating voltage, V DC	TTL logic level (see TTL logic level range)		Switching frequency
	ON	OFF	
5	2.4 to 5.5V	0 to 0.5V	Max. 180 cpm (ON time : OFF time = 1 : 1)
12			
24			

2. Transfer

1) Failsafe type

Nominal operating voltage, V DC	Nominal operating current, mA (+10%/–15%)	Nominal power consumption, mW
4.5	342.2	1540
12	128.3	1540
24	69.6	1670

2) Latching type

Nominal operating voltage, V DC	Nominal operating current, mA (+10%/–15%)	Nominal power consumption, mW
4.5	266.7	1200
12	104.2	1250
24	58.3	1400

3) Latching with TTL driver type (with self cut-off function)

Nominal operating voltage, V DC	TTL logic level (see TTL logic level range)		Switching frequency
	ON	OFF	
5	2.4 to 5.5V	0 to 0.5V	Max. 180 cpm (ON time : OFF time = 1 : 1)
12			
24			

3. SP6T

1) Failsafe type

Nominal operating voltage, V DC	Nominal operating current, mA (+10%/–15%)	Nominal power consumption, mW
4.5	186.7	840
12	70.0	840
24	40.4	970

2) Latching type

Nominal operating voltage, V DC	Nominal operating current, mA (+10%/–15%)	Nominal power consumption, mW
4.5	SET: 155.6 / RESET (ALL): 933.6	SET: 700 / RESET (ALL): 4,200
12	SET: 62.5 / RESET (ALL): 375.0	SET: 750 / RESET (ALL): 4,500
24	SET: 37.5 / RESET (ALL): 225.0	SET: 900 / RESET (ALL): 5,400

RD (ARD)

• Operating voltage range

1) Failsafe type

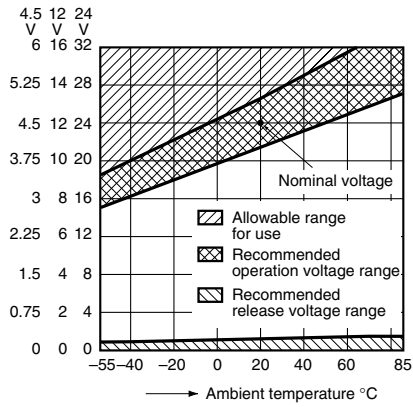

2) Latching type

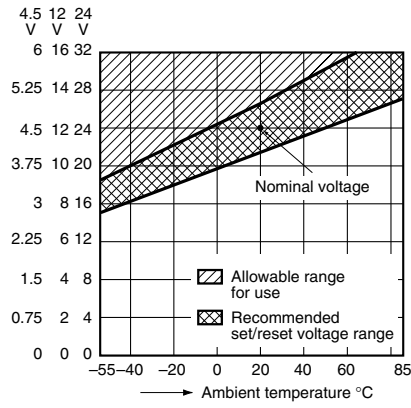

3) Latching with TTL driver type (with self cut-off function)

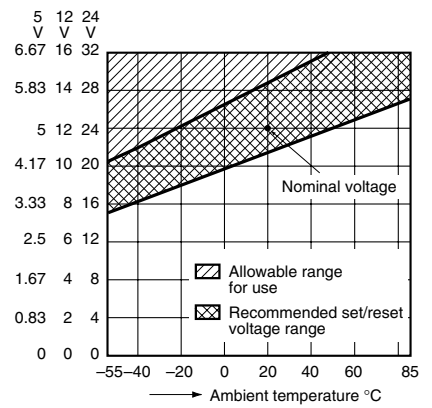

4) TTL Logic level range

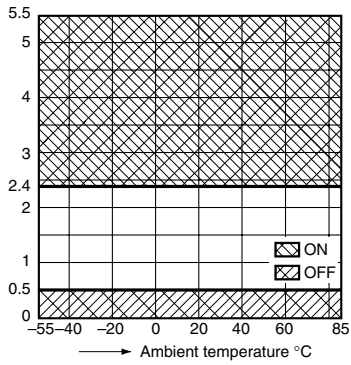

Note) Please consult us for use that is outside this range.

DIMENSIONS

1. SPDT

1) Solder terminal

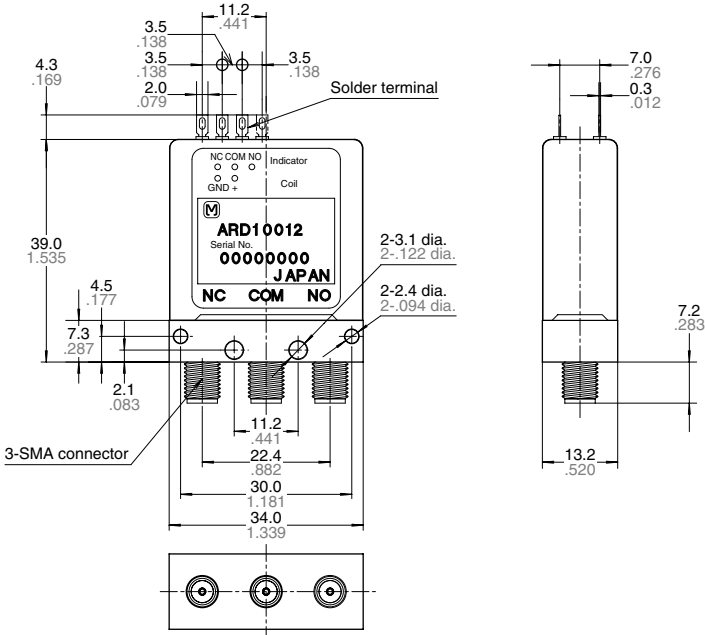

Tolerance: ±0.3 ±0.012

Failsafe

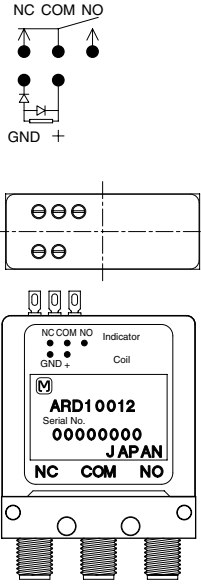

Latching

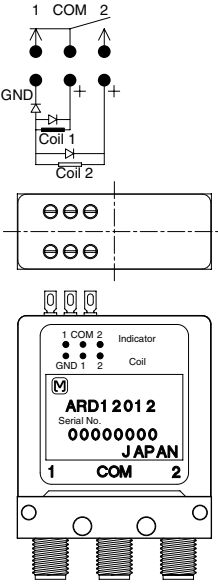

Latching with TTL driver (with self cut-off function)

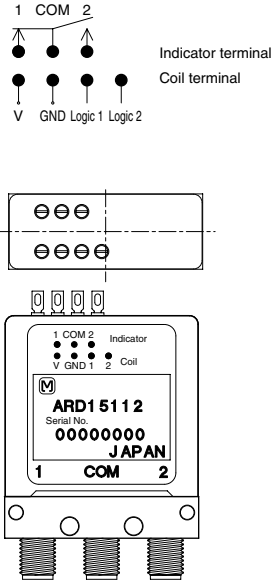

* + COM type is available

RD (ARD)

2) Connector cable

mm inch



Pin No.	Indicator					Coil			
	①	②	③	④	⑤	⑥	⑦	⑧	⑨
Fail safe	-	NC	COM	NO	-	-	GND	+	-
Latching	-	1	COM	2	-	-	GND	1	2
Latching with TTL driver	-	1	COM	2	-	V	GND	Logic 1	Logic 2

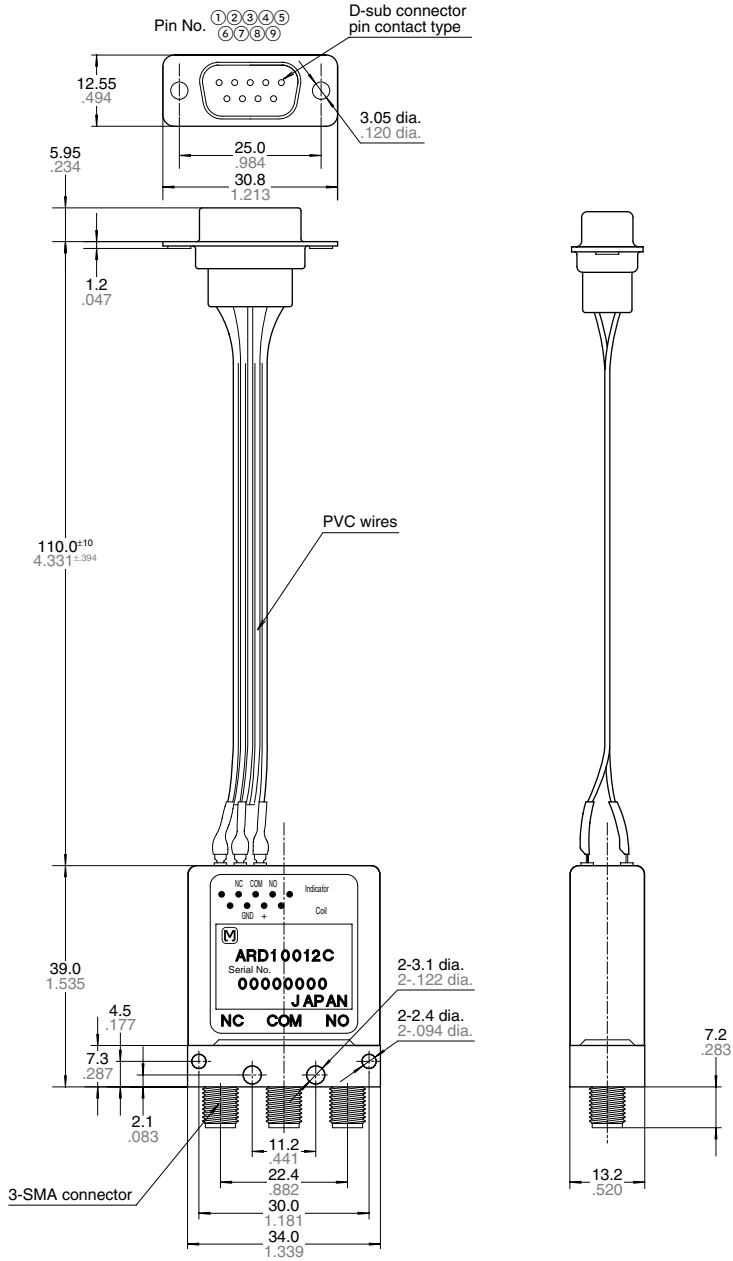

Tolerance: $\pm 0.3 \pm 0.12$

Failsafe

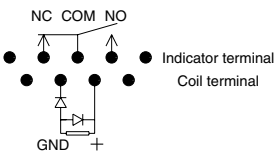

Latching

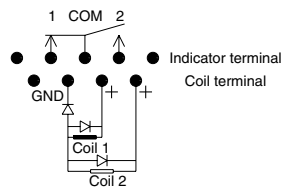

Latching with TTL driver
(with self cut-off function)

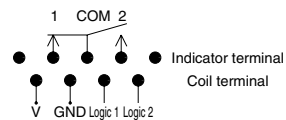

* + COM type is available

2. Transfer

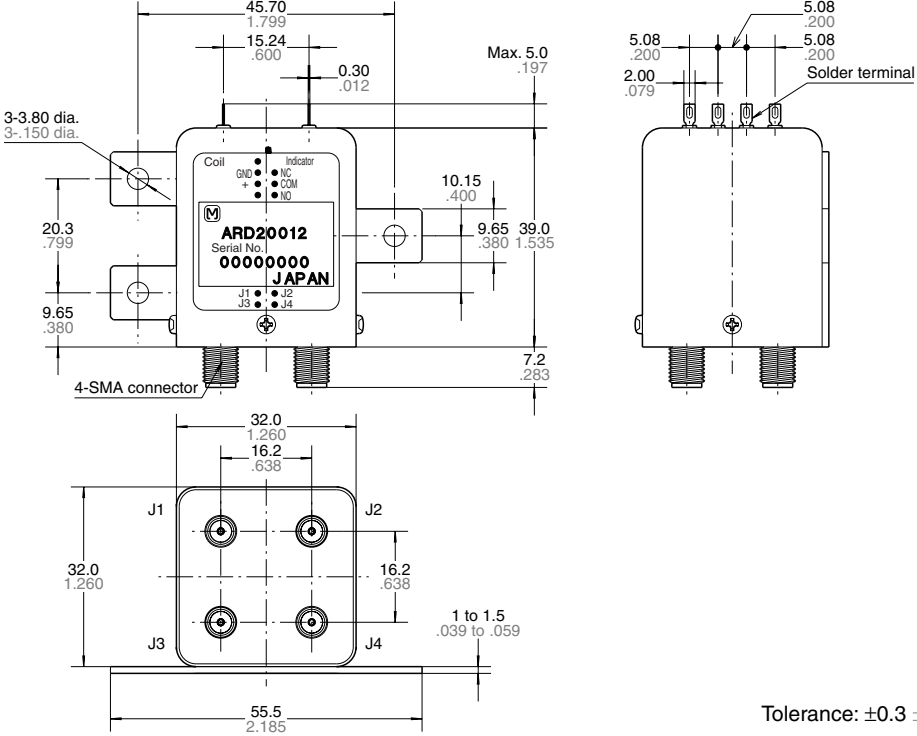

Tolerance: $\pm 0.3 \pm 0.12$

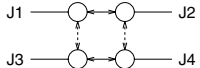

Fail safe	NC: J1-J2, J3-J4 NO: J1-J3, J2-J4
Latching	POS1: J1-J2, J3-J4 POS2: J1-J3, J2-J4
Latching with TTL driver	POS1: J1-J2, J3-J4 POS2: J1-J3, J2-J4

Failsafe

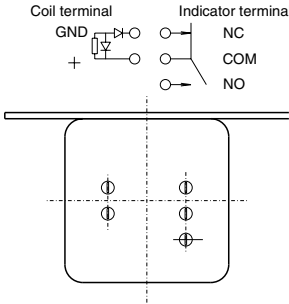

Latching

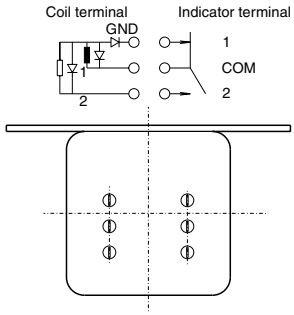

Latching with TTL driver
(with self cut-off function)

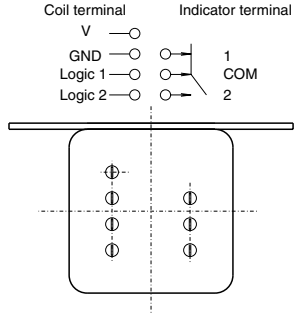

* + COM type is available

RD (ARD)

3. SP6T

mm inch

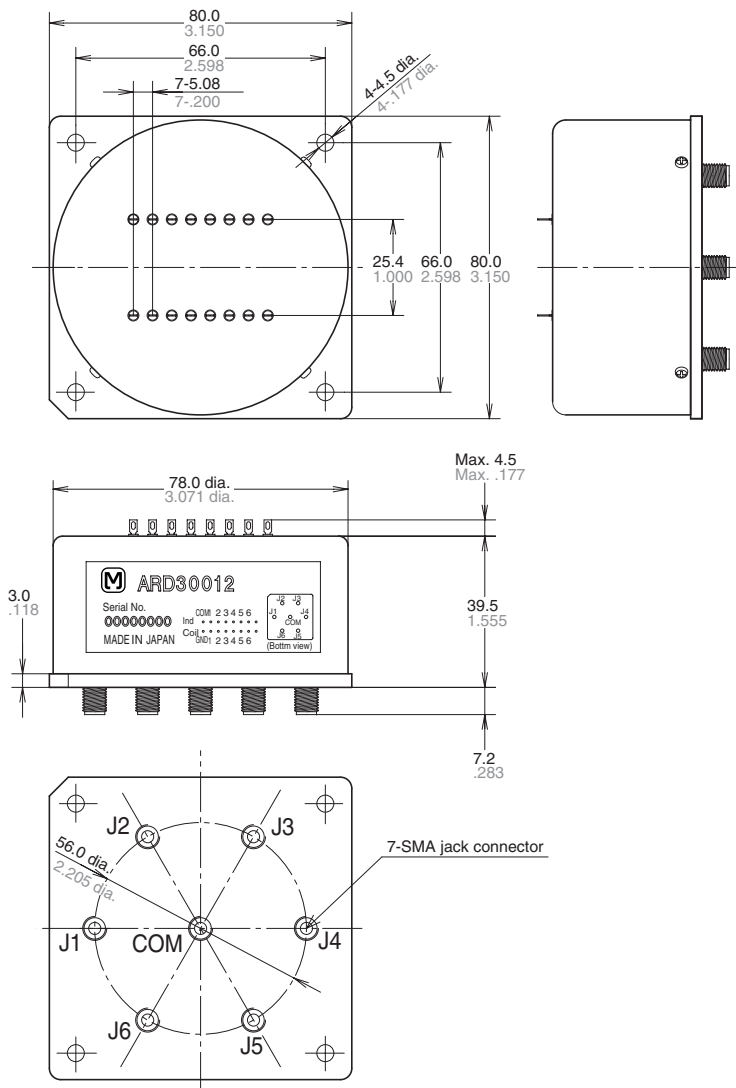

Failsafe type

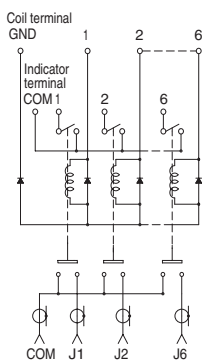

Latching type

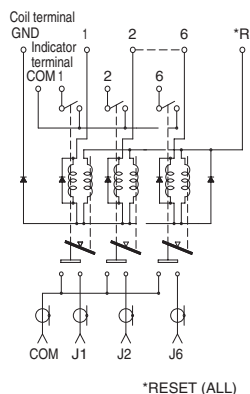

* 1. With termination type is available.
2. + COM type is available.

REFERENCE DATA

1-(1). High frequency characteristics (SPDT)

Sample: ARD10012
Measuring method: Measured with HP network analyzer (HP8510).

• V.S.W.R.

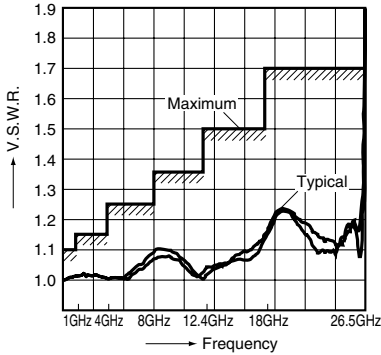

• Insertion loss

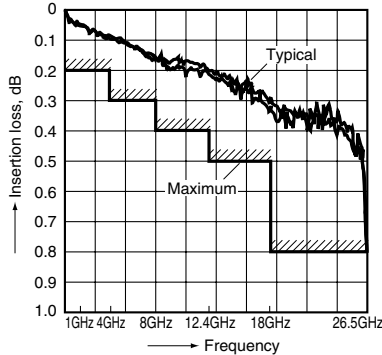

• Isolation

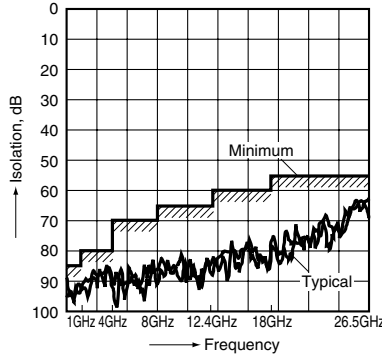

1-(2). High frequency characteristics (Transfer)

Sample: ARD60012
Measuring method: Measured with HP network analyzer (HP8510).

• V.S.W.R.

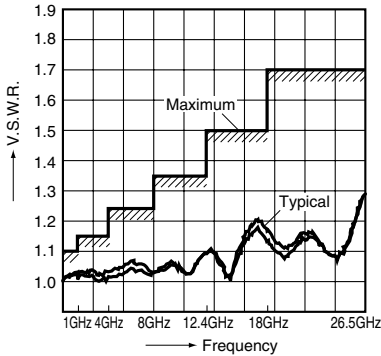

• Insertion loss

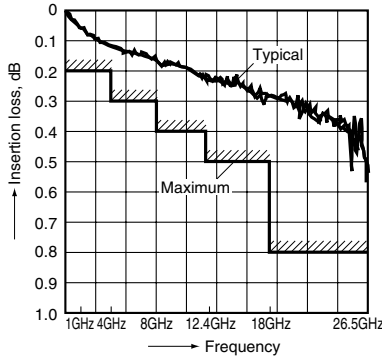

• Isolation

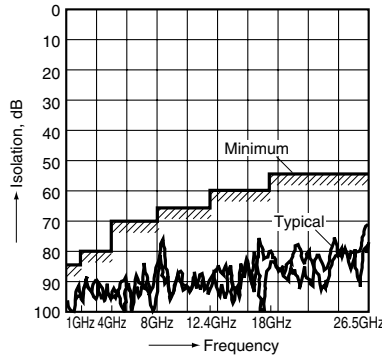

1-(3). High frequency characteristics (SP6T)

Measuring method: Measured with HP network analyzer (HP8510).

• V.S.W.R.

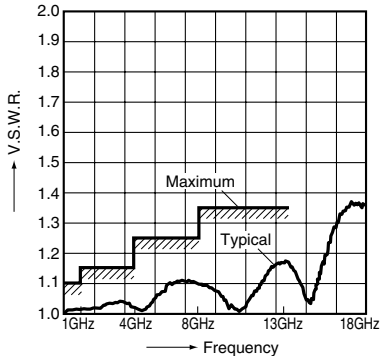

• Insertion loss

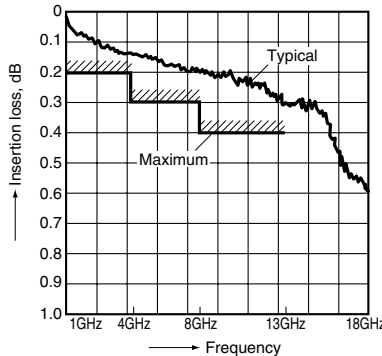

• Isolation

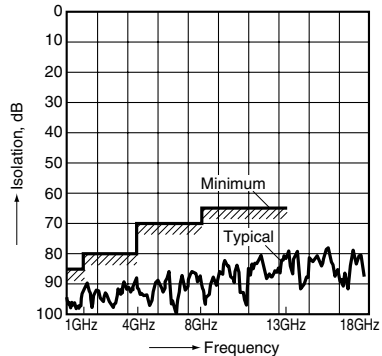

RD (ARD)

NOTES

1. Coil operating power

Pure DC current should be applied to the coil. The wave form should be rectangular. If it includes ripple, the ripple factor should be less than 5%.

However, check it with the actual circuit since the characteristics may be slightly different. The nominal operating voltage should be applied to the coil for more than 50 ms to set/reset the latching type relay.

Please use the latching type for circuits that are continually powered for long periods of time.

2. Coil connection

When connecting coils, refer to the wiring diagram to prevent mis-operation or malfunction.

3. Connection of coil indicator and washing conditions

1) The connection of coil indicator terminal shall be done by soldering.

Soldering conditions

Max. 260°C 500°F (solder temp) within 10sec (soldering time)

Max. 350°C 662°F (solder temp) within 3sec (soldering time)

2) This product is not sealed type, therefore washing is not allowed.

4. Conditions for operation, transport and storage conditions

1) Ambient temperature, humidity, and atmospheric pressure during usage, transport, and storage of the relay:

(1) Temperature:

-55 to +85°C -67 to +185°F

(2) Humidity: 5 to 85% RH

(Avoid freezing and condensation.)

The humidity range varies with the temperature. Use within the range indicated in the graph below.

(3) Atmospheric pressure: 86 to 106 kPa

Temperature and humidity range for usage, transport, and storage:

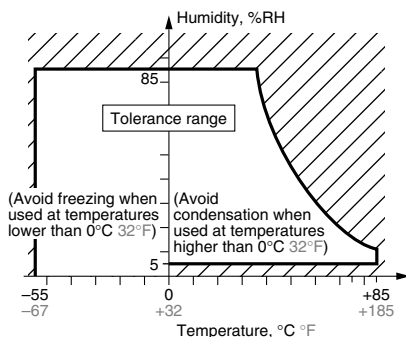

2) Condensation

Condensation forms when there is a sudden change in temperature under high temperature and high humidity conditions. Condensation will cause deterioration of the relay insulation.

3) Freezing

Condensation or other moisture may freeze on the relay when the temperature is lower than 0°C 32°F. This causes problems such as sticking of movable parts or operational time lags.

4) Low temperature, low humidity environments.

The plastic becomes brittle if the relay is exposed to a low temperature, low humidity environment for long periods of time.

5) Low-temperature and low-humidity atmosphere.

When exposed to low temperature and low humidity for a long time, the relay's plastic casing may become breakable.

5. Other handling precautions.

1) The relay's on/off service life is based on standard test conditions (temperature: 15 to 35°C 59 to 95°F, humidity: 25 to 75%) specified in JIS C5442-1996. Life will depend on many factors of your system: coil drive circuit, type of load, switching intervals, switching phase, ambient conditions, to name a few.

2) Use the relay within specifications such as coil rating, contact rating and on/off service life. If used beyond limits, the relay may overheat, generate smoke or catch fire.

3) Be careful not to drop the relay. If accidentally dropped, carefully check its appearance and characteristics before use.

4) Be careful to wire the relay correctly. Otherwise, malfunction, overheat, fire or other trouble may occur.

5) The latching type relay is shipped in the reset position. But jolts during transport or impacts during installation can move it to the set position. It is, therefore, advisable to build a circuit in which the relay can be initialized (set and reset) just after turning on the power.

6) If a relay stays on in a circuit for many months or years at a time without being activated, circuit design should be reviewed so that the relay can remain non-excited. A coil that receives current all the time heats, which degrades insulation earlier than expected. A latching type relay is recommended for such circuits.

7) For SMA connectors, we recommend a torque of 0.90±0.1 N·m for installation, which falls within the prescribed torque of MIL-C-39012. Please be aware that conditions might be different depending on the connector materials and how it interacts with surrounding materials.



8) Please do not use silicon based substances such as silicon rubber, silicon oil, silicon coatings and silicon fillings, in the vicinity of the relay. Doing so may cause volatile silicon gas to form which may lead to contact failure due to the adherence of silicon on the contacts when they open and close in this atmosphere.

9) Please note that when switching contacts (latching type only), you must apply reset (ALL) voltage and release all contacts first. (SP6T type)

10) Do not use multiple contacts simultaneously. (SP6T type)

Looking for pricing, stock, or lifecycle information?

Click below to explore more details on WIN SOURCE:

-  [View ARD1204H on WIN SOURCE](#)
-  [Panasonic Information](#)

Optimize Your Supply Chain with WIN SOURCE Solutions

-  Global Sourcing Solution
-  Obsolete Management
-  Cost Control Management
-  Shortage Management
-  Alternative Solution
-  Excess Inventory Management