



**THE DATASHEET OF  
CAT5241WI-10-T1**



# CAT5241

## Quad Digital Potentiometer (POT) with 64 Taps and I<sup>2</sup>C Interface



ON Semiconductor®

<http://onsemi.com>

### Description

The CAT5241 is four Digital POTs integrated with control logic and 16 bytes of NVRAM memory. Each digital POT consists of a series of 63 resistive elements connected between two externally accessible end points. The tap points between each resistive element are connected to the wiper outputs with CMOS switches. A separate 6-bit control register (WCR) independently controls the wiper tap switches for each digital POT. Associated with each wiper control register are four 6-bit non-volatile memory data registers (DR) used for storing up to four wiper settings. Writing to the wiper control register or any of the non-volatile data registers is via a I<sup>2</sup>C serial bus. On power-up, the contents of the first data register (DR0) for each of the four potentiometers is automatically loaded into its respective wiper control register (WCR).

The CAT5241 can be used as a potentiometer or as a two terminal, variable resistor. It is intended for circuit level or system level adjustments in a wide variety of applications.

### Features

- Four Linear-taper Digital Potentiometers
- 64 Resistor Taps per Potentiometer
- End to End Resistance 2.5 k $\Omega$ , 10 k $\Omega$ , 50 k $\Omega$  or 100 k $\Omega$
- Potentiometer Control and Memory Access via I<sup>2</sup>C Interface
- Low Wiper Resistance, Typically 80  $\Omega$
- Nonvolatile Memory Storage for up to Four Wiper Settings for Each Potentiometer
- Automatic Recall of Saved Wiper Settings at Power Up
- 2.5 to 6.0 Volt Operation
- Standby Current less than 1  $\mu$ A
- 1,000,000 Nonvolatile WRITE Cycles
- 100 Year Nonvolatile Memory Data Retention
- 20-lead SOIC and TSSOP Packages
- Industrial Temperature Range
- These Devices are Pb-Free, Halogen Free/BFR Free and are RoHS Compliant

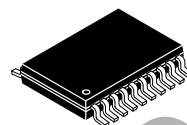

TSSOP-20  
Y SUFFIX  
CASE 948AQ

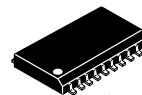

SOIC-20  
W SUFFIX  
CASE 751BJ

### PIN CONNECTIONS

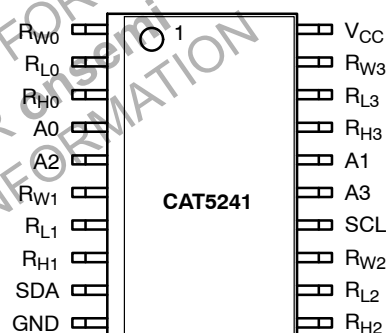

SOIC-20 (W)  
TSSOP-20 (Y)  
(Top View)

### ORDERING INFORMATION

See detailed ordering and shipping information in the package dimensions section on page 14 of this data sheet.

# CAT5241

## MARKING DIAGRAMS

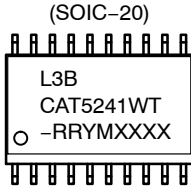

L = Assembly Location  
3 = Lead Finish - Matte-Tin  
B = Product Revision (Fixed as "B")  
CAT5241W = Device Code  
T = Temperature Range (I = Industrial)  
- = Dash  
RR = Resistance  
25 = 2.5 K $\Omega$   
10 = 10 K $\Omega$   
50 = 50 K $\Omega$   
00 = 100 K $\Omega$   
Y = Production Year (Last Digit)  
M = Production Month (1-9, O, N, D)  
XXXX = Last Four Digits of Assembly Lot Number

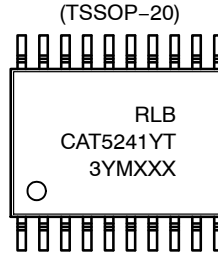

R = Resistance  
1 = 2.5 K $\Omega$   
2 = 10 K $\Omega$   
4 = 50 K $\Omega$   
5 = 100 K $\Omega$   
L = Assembly Location  
B = Product Revision (Fixed as "B")  
CAT5241Y = Device Code  
T = Temperature Range (I = Industrial)  
3 = Lead Finish - Matte-Tin  
Y = Production Year (Last Digit)  
M = Production Month (1-9, O, N, D)  
XXX = Last Three Digits of Assembly Lot Number

**DISCONTINUED**  
THIS DEVICE IS NOT RECOMMENDED FOR NEW DESIGN  
PLEASE CONTACT YOUR onsemi  
REPRESENTATIVE FOR INFORMATION

# CAT5241

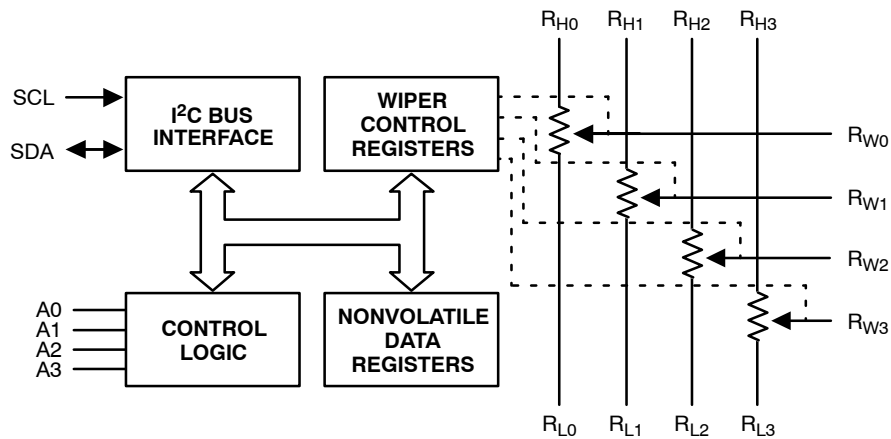

Figure 1. Functional Diagram

Table 1. PIN DESCRIPTION

| Pin (SOIC) | Name            | Function                                    |
|------------|-----------------|---|
| 1          | R <sub>W0</sub> | Wiper Terminal for Potentiometer 0          |
| 2          | R <sub>L0</sub> | Low Reference Terminal for Potentiometer 0  |
| 3          | R <sub>H0</sub> | High Reference Terminal for Potentiometer 0 |
| 4          | A0              | Device Address, LSB                         |
| 5          | A2              | Device Address                              |
| 6          | R <sub>W1</sub> | Wiper Terminal for Potentiometer 1          |
| 7          | R <sub>L1</sub> | Low Reference Terminal for Potentiometer 1  |
| 8          | R <sub>H1</sub> | High Reference Terminal for Potentiometer 1 |
| 9          | SDA             | Serial Data Input/Output                    |
| 10         | GND             | Ground                                      |
| 11         | R <sub>H2</sub> | High Reference Terminal for Potentiometer 2 |
| 12         | R <sub>L2</sub> | Low Reference Terminal for Potentiometer 2  |
| 13         | R <sub>W2</sub> | Wiper Terminal for Potentiometer 2          |
| 14         | SCL             | Bus Serial Clock                            |
| 15         | A3              | Device Address                              |
| 16         | A1              | Device Address                              |
| 17         | R <sub>H3</sub> | High Reference Terminal for Potentiometer 3 |
| 18         | R <sub>L3</sub> | Low Reference Terminal for Potentiometer 3  |
| 19         | R <sub>W3</sub> | Wiper Terminal for Potentiometer 3          |
| 20         | V <sub>CC</sub> | Supply Voltage                              |

## Pin Descriptions

### SCL: Serial Clock

The CAT5241 serial clock input pin is used to clock all data transfers into or out of the device.

### SDA: Serial Data

The CAT5241 bidirectional serial data pin is used to transfer data into and out of the device. The SDA pin is an open drain output and can be wire-OR'd with the other open drain or open collector outputs.

### A0, A1, A2, A3: Device Address Inputs

These inputs set the device address when addressing multiple devices. A total of sixteen devices can be addressed on a single bus. A match in the slave address must be made with the address input in order to initiate communication with the CAT5241.

### R<sub>H</sub>, R<sub>L</sub>: Resistor End Points

The four sets of R<sub>H</sub> and R<sub>L</sub> pins are equivalent to the terminal connections on a mechanical potentiometer.

### R<sub>W</sub>: Wiper

The four R<sub>W</sub> pins are equivalent to the wiper terminal of a mechanical potentiometer.

### Device Operation

The CAT5241 is four resistor arrays integrated with I<sup>2</sup>C serial interface logic, four 6-bit wiper control registers and sixteen 6-bit, non-volatile memory data registers. Each resistor array contains 63 separate resistive elements connected in series. The physical ends of each array are equivalent to the fixed terminals of a mechanical potentiometer (R<sub>H</sub> and R<sub>L</sub>). R<sub>H</sub> and R<sub>L</sub> are symmetrical and may be interchanged. The tap positions between and at the ends of the series resistors are connected to the output wiper terminals (R<sub>W</sub>) by a CMOS transistor switch. Only one tap point for each potentiometer is connected to its wiper terminal at a time and is determined by the value of the wiper control register. Data can be read or written to the wiper control registers or the non-volatile memory data registers via the I<sup>2</sup>C bus. Additional instructions allow data to be transferred between the wiper control registers and each respective potentiometer's non-volatile data registers. Also, the device can be instructed to operate in an "increment/decrement" mode.

**Table 2. ABSOLUTE MAXIMUM RATINGS**

| Parameter   | Ratings                       | Units |
|---|-------------------------------|-------|
| Temperature Under Bias  | -55 to +125                   | °C    |
| Storage Temperature Range                                       | -65 to +150                   | °C    |
| Voltage on any Pin with Respect to V <sub>SS</sub> (Notes 1, 2) | -2.0 to +V <sub>CC</sub> +2.0 | V     |
| V <sub>CC</sub> with Respect to Ground                          | -2.0 to +7.0                  | V     |
| Package Power Dissipation Capability (T <sub>A</sub> = 25°C)    | 1.0                           | W     |
| Lead Soldering Temperature (10 s)                               | 300                           | °C    |
| Wiper Current   | ±12                           | mA    |

Stresses exceeding Maximum Ratings may damage the device. Maximum Ratings are stress ratings only. Functional operation above the Recommended Operating Conditions is not implied. Extended exposure to stresses above the Recommended Operating Conditions may affect device reliability.

- The minimum DC input voltage is -0.5 V. During transitions, inputs may undershoot to -2.0 V for periods of less than 20 ns. Maximum DC voltage on output pins is V<sub>CC</sub> + 0.5 V, which may overshoot to V<sub>CC</sub> + 2.0 V for periods of less than 20 ns.
- Latch-up protection is provided for stresses up to 100 mA on address and data pins from -1 V to V<sub>CC</sub> + 1 V.

**Table 3. RECOMMENDED OPERATING CONDITIONS**

| Parameter                                  | Ratings      | Units |
|--|--------------|-------|
| V <sub>CC</sub>                            | +2.5 to +6.0 | V     |
| Operating Ambient Temperature (Industrial) | -40 to +85   | °C    |

**Table 4. POTENTIOMETER CHARACTERISTICS** (Over recommended operating conditions unless otherwise stated.)

| Symbol   | Parameter   | Test Conditions  | Min | Typ      | Max             | Units           |
|--|---|--|-----|----------|-----------------|-----------------|
| R <sub>POT</sub>                               | Potentiometer Resistance (-00)                      |  |     | 100      |                 | kΩ              |
| R <sub>POT</sub>                               | Potentiometer Resistance (-50)                      |  |     | 50       |                 | kΩ              |
| R <sub>POT</sub>                               | Potentiometer Resistance (-10)                      |  |     | 10       |                 | kΩ              |
| R <sub>POT</sub>                               | Potentiometer Resistance (-25)                      |  |     | 2.5      |                 | kΩ              |
|  | Potentiometer Resistance Tolerance                  |  |     |          | ±20             | %               |
|  | R <sub>POT</sub> Matching                           |  |     |          | 1               | %               |
|  | Power Rating  | 25°C, each pot   |     |          | 50              | mW              |
| I <sub>W</sub>                                 | Wiper Current                                       |  |     |          | ±6              | mA              |
| R <sub>W</sub>                                 | Wiper Resistance                                    | I <sub>W</sub> = ±3 mA @ V <sub>CC</sub> = 3 V                     |     |          | 300             | Ω               |
| R <sub>W</sub>                                 | Wiper Resistance                                    | I <sub>W</sub> = ±3 mA @ V <sub>CC</sub> = 5 V                     |     | 80       | 150             | Ω               |
| V <sub>TERM</sub>                              | Voltage on any R <sub>H</sub> or R <sub>L</sub> Pin | V <sub>SS</sub> = 0 V  | GND |          | V <sub>CC</sub> |                 |
| V <sub>N</sub>                                 | Noise   | (Note 3)   |     | TBD      |                 | nV/√Hz          |
|  | Resolution  |  |     | 1.6      |                 | %               |
|  | Absolute Linearity (Note 4)                         | R <sub>W(n)(actual)</sub> - R <sub>(n)(expected)</sub><br>(Note 7) |     |          | ±1              | LSB<br>(Note 6) |
|  | Relative Linearity (Note 5)                         | R <sub>W(n+1)</sub> - [R <sub>W(n)</sub> + LSB]<br>(Note 7)        |     |          | ±0.2            | LSB<br>(Note 6) |
| TC <sub>R<sub>POT</sub></sub>                  | Temperature Coefficient of R <sub>POT</sub>         | (Note 3)   |     | ±300     |                 | ppm/°C          |
| TC <sub>RATIO</sub>                            | Ratiometric Temp. Coefficient                       | (Note 3)   |     |          | 20              | ppm/°C          |
| C <sub>H</sub> /C <sub>L</sub> /C <sub>W</sub> | Potentiometer Capacitances                          | (Note 3)   |     | 10/10/25 |                 | pF              |
| f <sub>c</sub>                                 | Frequency Response                                  | R <sub>POT</sub> = 50 kΩ (Note 3)                                  |     | 0.4      |                 | MHz             |

- This parameter is tested initially and after a design or process change that affects the parameter.
- Absolute linearity is utilized to determine actual wiper voltage versus expected voltage as determined by wiper position when used as a potentiometer.
- Relative linearity is utilized to determine the actual change in voltage between two successive tap positions when used as a potentiometer. It is a measure of the error in step size.
- LSB = R<sub>TOT</sub> / 63 or (R<sub>H</sub> - R<sub>L</sub>) / 63, single pot
- n = 0, 1, 2, ..., 63

# CAT5241

**Table 5. D.C. OPERATING CHARACTERISTICS** (Over recommended operating conditions unless otherwise stated.)

| Symbol    | Parameter                                       | Test Conditions   | Min                 | Typ | Max                 | Units         |
|-----------|---|---|---------------------|-----|---------------------|---------------|
| $I_{CC}$  | Power Supply Current                            | $f_{SCL} = 400 \text{ kHz}$   |                     |     | 1                   | mA            |
| $I_{SB}$  | Standby Current ( $V_{CC} = 5.0 \text{ V}$ )    | $V_{IN} = \text{GND or } V_{CC};$<br>$SDA = \text{GND};$<br>$RWX = \text{GND (Note 8)}$ |                     |     | 1                   | $\mu\text{A}$ |
| $I_{LI}$  | Input Leakage Current                           | $V_{IN} = \text{GND to } V_{CC}$  |                     |     | 10                  | $\mu\text{A}$ |
| $I_{LO}$  | Output Leakage Current                          | $V_{OUT} = \text{GND to } V_{CC}$   |                     |     | 10                  | $\mu\text{A}$ |
| $V_{IL}$  | Input Low Voltage                               |   | -1                  |     | $V_{CC} \times 0.3$ | V             |
| $V_{IH}$  | Input High Voltage                              |   | $V_{CC} \times 0.7$ |     | $V_{CC} + 1.0$      | V             |
| $V_{OL1}$ | Output Low Voltage ( $V_{CC} = 3.0 \text{ V}$ ) | $I_{OL} = 3 \text{ mA}$   |                     |     | 0.4                 | V             |

8. All four wiper terminals RW0, RW1, RW2, and RW3 are tied to ground.

**Table 6. CAPACITANCE** (Note 9) ( $T_A = 25^\circ\text{C}$ ,  $f = 1.0 \text{ MHz}$ ,  $V_{CC} = +5.0 \text{ V}$ )

| Symbol    | Parameter                               | Test Conditions         | Min | Typ | Max | Units |
|-----------|---|-------------------------|-----|-----|-----|-------|
| $C_{I/O}$ | Input/Output Capacitance (SDA)          | $V_{I/O} = 0 \text{ V}$ |     |     | 8   | pF    |
| $C_{IN}$  | Input Capacitance (A0, A1, A2, A3, SCL) | $V_{IN} = 0 \text{ V}$  |     |     | 6   | pF    |

**Table 7. A.C. CHARACTERISTICS** (Over recommended operating conditions unless otherwise stated.)

| Symbol             | Parameter   | Min | Typ | Max | Units         |
|--------------------|---|-----|-----|-----|---------------|
| $f_{SCL}$          | Clock Frequency   |     |     | 400 | kHz           |
| $T_I$ (Note 9)     | Noise Suppression Time Constant at SCL, SDA Inputs            |     |     | 50  | ns            |
| $t_{AA}$           | SLC Low to SDA Data Out and ACK Out                           |     |     | 0.9 | $\mu\text{s}$ |
| $t_{BUF}$ (Note 9) | Time the Bus Must Be Free Before a New Transmission Can Start | 1.2 |     |     | $\mu\text{s}$ |
| $t_{HD:STA}$       | Start Condition Hold Time                                     | 0.6 |     |     | $\mu\text{s}$ |
| $t_{LOW}$          | Clock Low Period  | 1.2 |     |     | $\mu\text{s}$ |
| $t_{HIGH}$         | Clock High Period   | 0.6 |     |     | $\mu\text{s}$ |
| $t_{SU:STA}$       | Start Condition Setup Time (For a Repeated Start Condition)   | 0.6 |     |     | $\mu\text{s}$ |
| $t_{HD:DAT}$       | Data in Hold Time   | 0   |     |     | ns            |
| $t_{SU:DAT}$       | Data in Setup Time  | 100 |     |     | ns            |
| $t_R$ (Note 9)     | SDA and SCL Rise Time   |     |     | 0.3 | $\mu\text{s}$ |
| $t_F$ (Note 9)     | SDA and SCL Fall Time   |     |     | 300 | ns            |
| $t_{SU:STO}$       | Stop Condition Setup Time                                     | 0.6 |     |     | $\mu\text{s}$ |
| $t_{DH}$           | Data Out Hold Time  | 50  |     |     | ns            |

**Table 8. POWER UP TIMING** (Note 9) (Over recommended operating conditions unless otherwise stated.)

| Symbol    | Parameter                   | Min | Typ | Max | Units |
|-----------|-----------------------------|-----|-----|-----|-------|
| $t_{PUR}$ | Power-up to Read Operation  |     |     | 1   | ms    |
| $t_{PUW}$ | Power-up to Write Operation |     |     | 1   | ms    |

9. This parameter is tested initially and after a design or process change that affects the parameter.

**Table 9. WRITE CYCLE LIMITS** (Note 10) (Over recommended operating conditions unless otherwise stated.)

| Symbol   | Parameter        | Min | Typ | Max | Units |
|----------|------------------|-----|-----|-----|-------|
| $t_{WR}$ | Write Cycle Time |     |     | 5   | ms    |

10. The write cycle is the time from a valid stop condition of a write sequence to the end of the internal program/erase cycle. During the write cycle, the bus interface circuits are disabled, SDA is allowed to remain high, and the device does not respond to its slave address.

# CAT5241

**Table 10. RELIABILITY CHARACTERISTICS** (Over recommended operating conditions unless otherwise stated.)

| Symbol                   | Parameter          | Reference Test Method         | Min       | Typ | Max | Units       |
|--------------------------|--------------------|-------------------------------|-----------|-----|-----|-------------|
| $N_{END}$ (Note 11)      | Endurance          | MIL-STD-883, Test Method 1033 | 1,000,000 |     |     | Cycles/Byte |
| $T_{DR}$ (Note 11)       | Data Retention     | MIL-STD-883, Test Method 1008 | 100       |     |     | Years       |
| $V_{ZAP}$ (Note 11)      | ESD Susceptibility | MIL-STD-883, Test Method 3015 | 2000      |     |     | Volts       |
| $I_{LTH}$ (Notes 11, 12) | Latch-Up           | JEDEC Standard 17             | 100       |     |     | mA          |

11. This parameter is tested initially and after a design or process change that affects the parameter.

12.  $t_{PUR}$  and  $t_{PUW}$  are the delays required from the time  $V_{CC}$  is stable until the specified operation can be initiated.

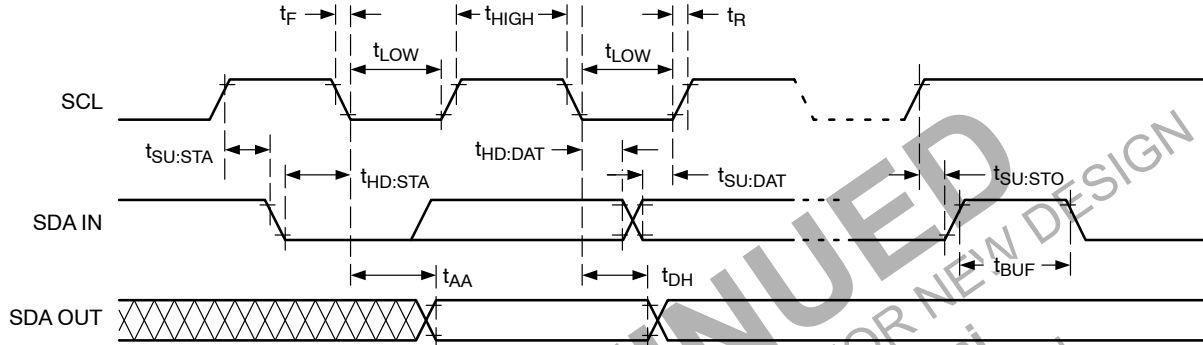

**Figure 2. Bus Timing**

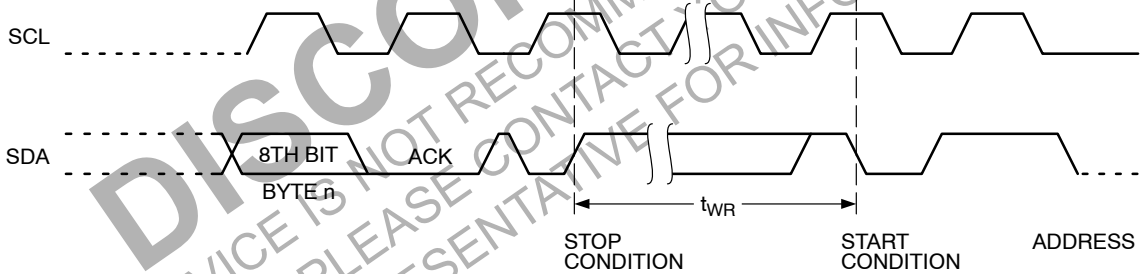

**Figure 3. Write Cycle Timing**

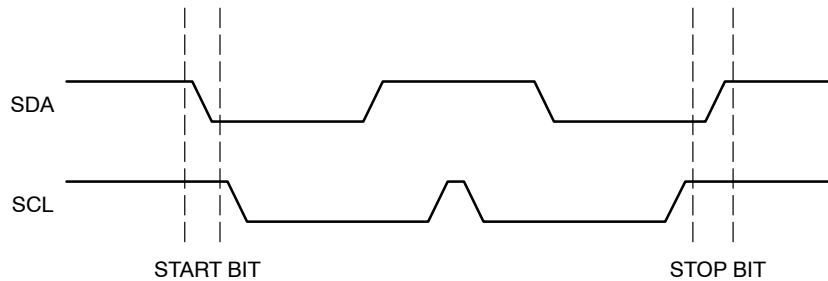

**Figure 4. Start/Stop Timing**

**Serial Bus Protocol**

The following defines the features of the I<sup>2</sup>C bus protocol:

1. Data transfer may be initiated only when the bus is not busy.
2. During a data transfer, the data line must remain stable whenever the clock line is high. Any changes in the data line while the clock is high will be interpreted as a START or STOP condition.

The device controlling the transfer is a master, typically a processor or controller, and the device being controlled is the slave. The master will always initiate data transfers and provide the clock for both transmit and receive operations. Therefore, the CAT5241 will be considered a slave device in all applications.

**START Condition**

The START Condition precedes all commands to the device, and is defined as a HIGH to LOW transition of SDA when SCL is HIGH. The CAT5241 monitors the SDA and SCL lines and will not respond until this condition is met.

**STOP Condition**

A LOW to HIGH transition of SDA when SCL is HIGH determines the STOP condition. All operations must end with a STOP condition.

**Device Addressing**

The bus Master begins a transmission by sending a START condition. The Master then sends the address of the

particular slave device it is requesting. The four most significant bits of the 8-bit slave address are fixed as 0101 for the CAT5241 (see Figure 6). The next four significant bits (A3, A2, A1, A0) are the device address bits and define which device the Master is accessing. Up to sixteen devices may be individually addressed by the system. Typically, +5 V and ground are hard-wired to these pins to establish the device's address.

After the Master sends a START condition and the slave address byte, the CAT5241 monitors the bus and responds with an acknowledge (on the SDA line) when its address matches the transmitted slave address.

**Acknowledge**

After a successful data transfer, each receiving device is required to generate an acknowledge. The Acknowledging device pulls down the SDA line during the ninth clock cycle, signaling that it received the 8 bits of data.

The CAT5241 responds with an acknowledge after receiving a START condition and its slave address. If the device has been selected along with a write operation, it responds with an acknowledge after receiving each 8-bit byte.

When the CAT5241 is in a READ mode it transmits 8 bits of data, releases the SDA line, and monitors the line for an acknowledge. Once it receives this acknowledge, the CAT5241 will continue to transmit data. If no acknowledge is sent by the Master, the device terminates data transmission and waits for a STOP condition.

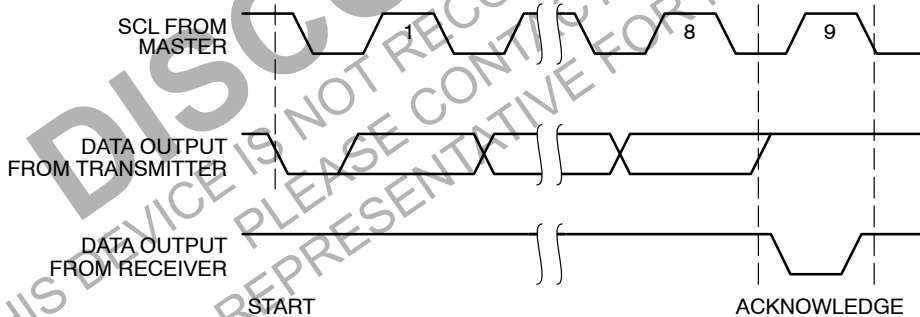

**Figure 5. Acknowledge Timing**

# CAT5241

## Write Operation

In the Write mode, the Master device sends the START condition and the slave address information to the Slave device. After the Slave generates an acknowledge, the Master sends the instruction byte that defines the requested operation of CAT5241. The instruction byte consist of a four-bit opcode followed by two register selection bits and two pot selection bits. After receiving another acknowledge from the Slave, the Master device transmits the data to be written into the selected register. The CAT5241 acknowledges once more and the Master generates the STOP condition, at which time if a non-volatile data register is being selected, the device begins an internal programming cycle to non-volatile memory. While this internal cycle is in progress, the device will not respond to any request from the Master device.

## Acknowledge Polling

The disabling of the inputs can be used to take advantage of the typical write cycle time. Once the stop condition is issued to indicate the end of the host's write operation, the CAT5241 initiates the internal write cycle. ACK polling can be initiated immediately. This involves issuing the start condition followed by the slave address. If the CAT5241 is still busy with the write operation, no ACK will be returned. If the CAT5241 has completed the write operation, an ACK will be returned and the host can then proceed with the next instruction operation.

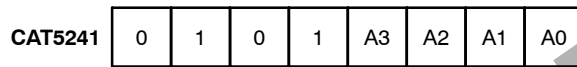

- \* A0, A1, A2 and A3 correspond to pin A0, A1, A2 and A3 of the device.
- \*\* A0, A1, A2 and A3 must compare to its corresponding hard wired input pins.

Figure 6. Slave Address Bits

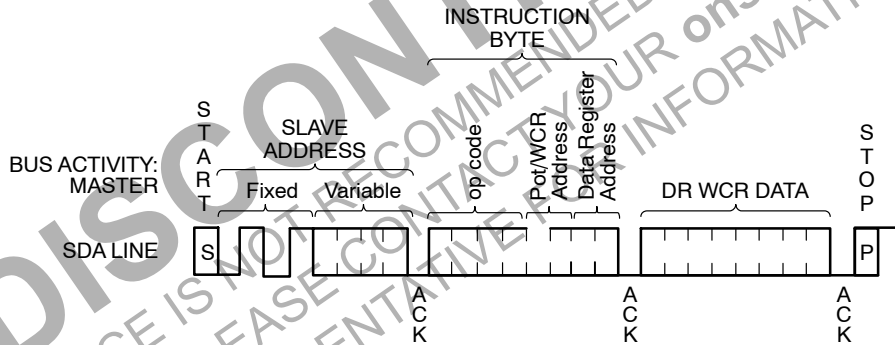

Figure 7. Write Timing

**Instructions and Register Description**

**Slave Address Byte**

The first byte sent to the CAT5241 from the master/processor is called the Slave Address Byte. The most significant four bits of the slave address are a device type identifier. These bits for the CAT5241 are fixed at 0101[B] (refer to Figure 8).

The next four bits, A3 – A0, are the internal slave address and must match the physical device address which is defined by the state of the A3 – A0 input pins for the CAT5241 to successfully continue the command sequence. Only the device which slave address matches the incoming device address sent by the master executes the instruction. The A3 – A0 inputs can be actively driven by CMOS input signals or tied to V<sub>CC</sub> or V<sub>SS</sub>.

**Instruction Byte**

The next byte sent to the CAT5241 contains the instruction and register pointer information. The four most significant bits used provide the instruction opcode I [3:0]. The P1 and P0 bits point to one of four Wiper Control Registers. The least two significant bits, R1 and R0, point to one of the four data registers of each associated potentiometer. The format is shown in Figure 9.

**Table 11. DATA REGISTER SELECTION**

| Data Register Selected | R1 | R0 |
|------------------------|----|----|
| DR0                    | 0  | 0  |
| DR1                    | 0  | 1  |
| DR2                    | 1  | 0  |
| DR3                    | 1  | 1  |

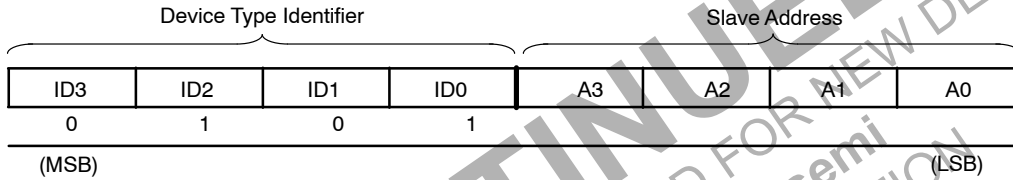

**Figure 8. Identification Byte Format**

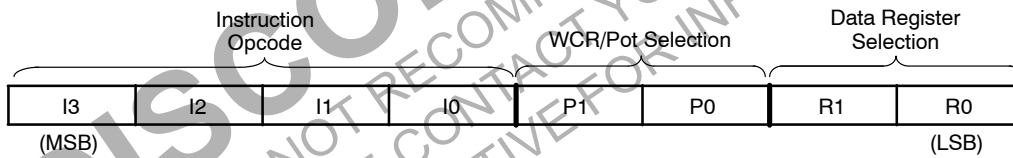

**Figure 9. Instruction Byte Format**

**Wiper Control and Data Registers**

**Wiper Control Register (WCR)**

The CAT5241 contains four 6-bit Wiper Control Registers, one for each potentiometer. The Wiper Control Register output is decoded to select one of 64 switches along its resistor array. The contents of the WCR can be altered in four ways: it may be written by the host via Write Wiper Control Register instruction; it may be written by transferring the contents of one of four associated Data Registers via the XFR Data Register instruction, it can be modified one step at a time by the Increment/decrement instruction (see Instruction section for more details). Finally, it is loaded with the content of its data register zero (DR0) upon power-up.

The Wiper Control Register is a volatile register that loses its contents when the CAT5241 is powered-down. Although the register is automatically loaded with the value in DR0 upon power-up, this may be different from the value present at power-down.

**Data Registers (DR)**

Each potentiometer has four 6-bit non-volatile Data Registers. These can be read or written directly by the host. Data can also be transferred between any of the four Data Registers and the associated Wiper Control Register. Any data changes in one of the Data Registers is a non-volatile operation and will take a maximum of 5 ms.

If the application does not require storage of multiple settings for the potentiometer, the Data Registers can be used as standard memory locations for system parameters or user preference data.

**Instructions**

Four of the nine instructions are three bytes in length. These instructions are:

- **Read Wiper Control Register** – read the current wiper position of the selected potentiometer in the WCR
- **Write Wiper Control Register** – change current wiper position in the WCR of the selected potentiometer
- **Read Data Register** – read the contents of the selected Data Register
- **Write Data Register** – write a new value to the selected Data Register.

**Table 12. INSTRUCTION SET** (Note: 1/0 = data is one or zero)

| Instruction  | Instruction Set |    |    |    |         |         |     |     | Operations  |
|--|-----------------|----|----|----|---------|---------|-----|-----|---|
|  | I3              | I2 | I1 | I0 | WCR1/P1 | WCR0/P0 | R1  | R0  |   |
| Read Wiper Control Register                          | 1               | 0  | 0  | 1  | 1/0     | 1/0     | 0   | 0   | Read the contents of the Wiper Control Register pointed to by P1–P0   |
| Write Wiper Control Register                         | 1               | 0  | 1  | 0  | 1/0     | 1/0     | 0   | 0   | Write new value to the Wiper Control Register pointed to by P1–P0   |
| Read Data Register                                   | 1               | 0  | 1  | 1  | 1/0     | 1/0     | 1/0 | 1/0 | Read the contents of the Data Register pointed to by P1–P0 and R1–R0  |
| Write Data Register                                  | 1               | 1  | 0  | 0  | 1/0     | 1/0     | 1/0 | 1/0 | Write new value to the Data Register pointed to by P1–P0 and R1–R0  |
| XFR Data Register to Wiper Control Register          | 1               | 1  | 0  | 1  | 1/0     | 1/0     | 1/0 | 1/0 | Transfer the contents of the Data Register pointed to by P1–P0 and R1–R0 to its associated Wiper Control Register             |
| XFR Wiper Control Register to Data Register          | 1               | 1  | 1  | 0  | 1/0     | 1/0     | 1/0 | 1/0 | Transfer the contents of the Wiper Control Register pointed to by P1–P0 to the Data Register pointed to by R1–R0              |
| Global XFR Data Registers to Wiper Control Registers | 0               | 0  | 0  | 1  | 0       | 0       | 1/0 | 1/0 | Transfer the contents of the Data Registers pointed to by R1–R0 of all four pots to their respective Wiper Control Registers  |
| Global XFR Wiper Control Registers to Data Register  | 1               | 0  | 0  | 0  | 0       | 0       | 1/0 | 1/0 | Transfer the contents of both Wiper Control Registers to their respective data Registers pointed to by R1–R0 of all four pots |
| Increment/Decrement Wiper Control Register           | 0               | 0  | 1  | 0  | 1/0     | 1/0     | 0   | 0   | Enable Increment/decrement of the Control Latch pointed to by P1–P0   |

The basic sequence of the three byte instructions is illustrated in Figure 11. These three-byte instructions exchange data between the WCR and one of the Data Registers. The WCR controls the position of the wiper. The response of the wiper to this action will be delayed by  $t_{WRL}$ . A transfer from the WCR (current wiper position), to a Data Register is a write to non-volatile memory and takes a maximum of  $t_{WR}$  to complete. The transfer can occur between one of the four potentiometers and one of its associated registers; or the transfer can occur between all potentiometers and one associated register.

Four instructions require a two-byte sequence to complete, as illustrated in Figure 10. These instructions transfer data between the host/processor and the CAT5241; either between the host and one of the data registers or directly between the host and the Wiper Control Register. These instructions are:

- **XFR Data Register to Wiper Control Register**  
This transfers the contents of one specified Data Register to the associated Wiper Control Register.
- **XFR Wiper Control Register to Data Register**  
This transfers the contents of the specified Wiper Control Register to the specified associated Data Register.

• **Global XFR Data Register to Wiper Control Register**

This transfers the contents of all specified Data Registers to the associated Wiper Control Registers.

• **Global XFR Wiper Control Register to Data Register**

This transfers the contents of all Wiper Control Registers to the specified associated Data Registers.

**Increment/Decrement Command**

The final command is Increment/Decrement (Figures 6 and 12). The Increment/Decrement command is different from the other commands. Once the command is issued and the CAT5241 has responded with an acknowledge, the master can clock the selected wiper up and/or down in one segment steps; thereby providing a fine tuning capability to the host. For each SCL clock pulse ( $t_{HIGH}$ ) while SDA is HIGH, the selected wiper will move one resistor segment towards the  $R_H$  terminal. Similarly, for each SCL clock pulse while SDA is LOW, the selected wiper will move one resistor segment towards the  $R_L$  terminal.

See Instructions format for more detail.

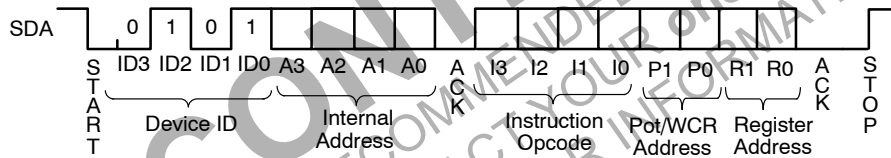

Figure 10. Two-Byte Instruction Sequence

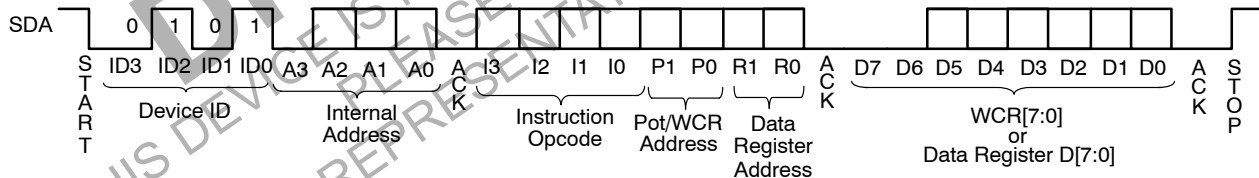
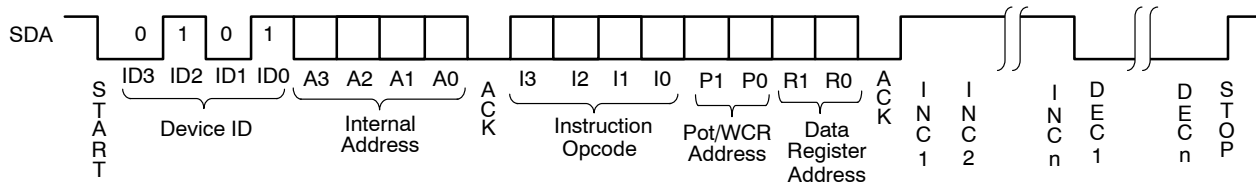

Figure 11. Three-Byte Instruction Sequence



# CAT5241

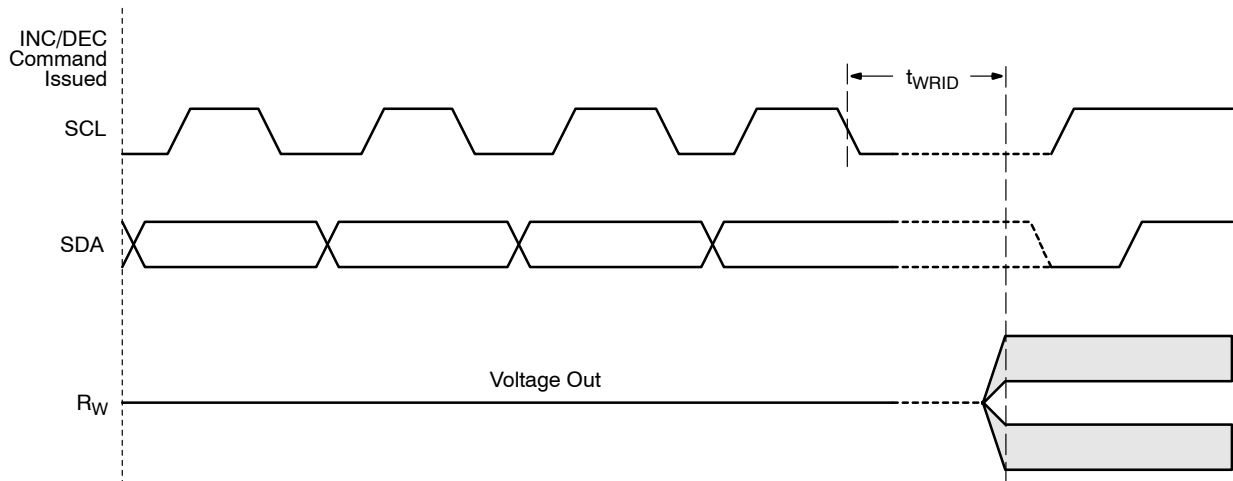

Figure 13. Increment/Decrement Timing Limits

## Instruction Format

Table 13. READ WIPER CONTROL REGISTER (WCR)

| S<br>T<br>A<br>R<br>T | DEVICE ADDRESSES |   |   |   |    |    |    |    | A<br>C<br>K | INSTRUCTION |   |   |   |    |    | A<br>C<br>K | DATA |   |   |   |   |   |   |   | A<br>C<br>K | S<br>T<br>O<br>P |   |   |  |  |
|-----------------------|------------------|---|---|---|----|----|----|----|-------------|-------------|---|---|---|----|----|-------------|------|---|---|---|---|---|---|---|-------------|------------------|---|---|--|--|
|                       | 0                | 1 | 0 | 1 | A3 | A2 | A1 | A0 |             | 1           | 0 | 0 | 1 | P1 | P0 |             | 0    | 0 | 7 | 6 | 5 | 4 | 3 | 2 |             |                  | 1 | 0 |  |  |
|                       |                  |   |   |   |    |    |    |    |             |             |   |   |   |    |    |             |      |   |   |   |   |   |   |   |             |                  |   |   |  |  |

Table 14. WRITE WIPER CONTROL REGISTER (WCR)

| S<br>T<br>A<br>R<br>T | DEVICE ADDRESSES |   |   |   |    |    |    |    | A<br>C<br>K | INSTRUCTION |   |   |   |    |    | A<br>C<br>K | DATA |   |   |   |   |   |   |   | A<br>C<br>K | S<br>T<br>O<br>P |   |   |  |  |
|-----------------------|------------------|---|---|---|----|----|----|----|-------------|-------------|---|---|---|----|----|-------------|------|---|---|---|---|---|---|---|-------------|------------------|---|---|--|--|
|                       | 0                | 1 | 0 | 1 | A3 | A2 | A1 | A0 |             | 1           | 0 | 1 | 0 | P1 | P0 |             | 0    | 0 | 7 | 6 | 5 | 4 | 3 | 2 |             |                  | 1 | 0 |  |  |
|                       |                  |   |   |   |    |    |    |    |             |             |   |   |   |    |    |             |      |   |   |   |   |   |   |   |             |                  |   |   |  |  |

Table 15. READ DATA REGISTER (DR)

| S<br>T<br>A<br>R<br>T | DEVICE ADDRESSES |   |   |   |    |    |    |    | A<br>C<br>K | INSTRUCTION |   |   |   |    |    | A<br>C<br>K | DATA |    |   |   |   |   |   |   | A<br>C<br>K | S<br>T<br>O<br>P |   |   |  |  |
|-----------------------|------------------|---|---|---|----|----|----|----|-------------|-------------|---|---|---|----|----|-------------|------|----|---|---|---|---|---|---|-------------|------------------|---|---|--|--|
|                       | 0                | 1 | 0 | 1 | A3 | A2 | A1 | A0 |             | 1           | 0 | 1 | 1 | P1 | P0 |             | R1   | R0 | 7 | 6 | 5 | 4 | 3 | 2 |             |                  | 1 | 0 |  |  |
|                       |                  |   |   |   |    |    |    |    |             |             |   |   |   |    |    |             |      |    |   |   |   |   |   |   |             |                  |   |   |  |  |

Table 16. WRITE DATA REGISTER (DR)

| S<br>T<br>A<br>R<br>T | DEVICE ADDRESSES |   |   |   |    |    |    |    | A<br>C<br>K | INSTRUCTION |   |   |   |    |    | A<br>C<br>K | DATA |    |   |   |   |   |   |   | A<br>C<br>K | S<br>T<br>O<br>P |   |   |  |  |
|-----------------------|------------------|---|---|---|----|----|----|----|-------------|-------------|---|---|---|----|----|-------------|------|----|---|---|---|---|---|---|-------------|------------------|---|---|--|--|
|                       | 0                | 1 | 0 | 1 | A3 | A2 | A1 | A0 |             | 1           | 1 | 0 | 0 | P1 | P0 |             | R1   | R0 | 7 | 6 | 5 | 4 | 3 | 2 |             |                  | 1 | 0 |  |  |
|                       |                  |   |   |   |    |    |    |    |             |             |   |   |   |    |    |             |      |    |   |   |   |   |   |   |             |                  |   |   |  |  |

Instruction Format (continued)

Table 17. GLOBAL TRANSFER DATA REGISTER (DR)  
TO WIPER CONTROL REGISTER (WCR)

|                       |                  |   |   |   |    |    |    |    |             |             |   |   |   |   |   |             |                  |
|-----------------------|------------------|---|---|---|----|----|----|----|-------------|-------------|---|---|---|---|---|-------------|------------------|
| S<br>T<br>A<br>R<br>T | DEVICE ADDRESSES |   |   |   |    |    |    |    | A<br>C<br>K | INSTRUCTION |   |   |   |   |   | A<br>C<br>K | S<br>T<br>O<br>P |
|                       | 0                | 1 | 0 | 1 | A3 | A2 | A1 | A0 |             | 0           | 0 | 0 | 1 | 0 | 0 |             |                  |

Table 18. GLOBAL TRANSFER WIPER CONTROL REGISTER (WCR)  
TO DATA REGISTER (DR)

|                       |                  |   |   |   |    |    |    |    |             |             |   |   |   |   |   |             |                  |
|-----------------------|------------------|---|---|---|----|----|----|----|-------------|-------------|---|---|---|---|---|-------------|------------------|
| S<br>T<br>A<br>R<br>T | DEVICE ADDRESSES |   |   |   |    |    |    |    | A<br>C<br>K | INSTRUCTION |   |   |   |   |   | A<br>C<br>K | S<br>T<br>O<br>P |
|                       | 0                | 1 | 0 | 1 | A3 | A2 | A1 | A0 |             | 1           | 0 | 0 | 0 | 0 | 0 |             |                  |

Table 19. TRANSFER WIPER CONTROL REGISTER (WCR)  
TO DATA REGISTER (DR)

|                       |                  |   |   |   |    |    |    |    |             |             |   |   |   |    |    |             |                  |
|-----------------------|------------------|---|---|---|----|----|----|----|-------------|-------------|---|---|---|----|----|-------------|------------------|
| S<br>T<br>A<br>R<br>T | DEVICE ADDRESSES |   |   |   |    |    |    |    | A<br>C<br>K | INSTRUCTION |   |   |   |    |    | A<br>C<br>K | S<br>T<br>O<br>P |
|                       | 0                | 1 | 0 | 1 | A3 | A2 | A1 | A0 |             | 1           | 1 | 1 | 0 | P1 | P0 |             |                  |

Table 20. TRANSFER DATA REGISTER (DR)  
TO WIPER CONTROL REGISTER (WCR)

|                       |                  |   |   |   |    |    |    |    |             |             |   |   |   |    |    |             |                  |
|-----------------------|------------------|---|---|---|----|----|----|----|-------------|-------------|---|---|---|----|----|-------------|------------------|
| S<br>T<br>A<br>R<br>T | DEVICE ADDRESSES |   |   |   |    |    |    |    | A<br>C<br>K | INSTRUCTION |   |   |   |    |    | A<br>C<br>K | S<br>T<br>O<br>P |
|                       | 0                | 1 | 0 | 1 | A3 | A2 | A1 | A0 |             | 1           | 1 | 0 | 1 | P1 | P0 |             |                  |

Table 21. INCREMENT (I)/DECREMENT (D) WIPER CONTROL REGISTER (WCR)

|                       |                  |   |   |   |    |    |    |    |             |             |   |   |   |    |    |      |   |     |     |     |                  |
|-----------------------|------------------|---|---|---|----|----|----|----|-------------|-------------|---|---|---|----|----|------|---|-----|-----|-----|------------------|
| S<br>T<br>A<br>R<br>T | DEVICE ADDRESSES |   |   |   |    |    |    |    | A<br>C<br>K | INSTRUCTION |   |   |   |    |    | DATA |   |     |     |     | S<br>T<br>O<br>P |
|                       | 0                | 1 | 0 | 1 | A3 | A2 | A1 | A0 |             | 0           | 0 | 1 | 0 | P1 | P0 | 0    | 0 | I/D | I/D | ... |                  |

NOTE: Any write or transfer to the Non-volatile Data Registers is followed by a high voltage cycle after a STOP has been issued.

# CAT5241

**Table 22. ORDERING INFORMATION**

| Orderable Part Number | Resistance (kΩ) | Lead Finish | Package            | Shipping <sup>†</sup> |
|-----------------------|-----------------|-------------|--------------------|-----------------------|
| CAT5241WI-25-T1       | 2.5             | Matte-Tin   | SOIC<br>(Pb-Free)  | 1000 / Tape & Reel    |
| CAT5241WI-10-T1       | 10              |             |                    |                       |
| CAT5241WI-50-T1       | 50              |             |                    |                       |
| CAT5241WI-00-T1       | 100             |             |                    |                       |
| CAT5241YI-25-T2       | 2.5             |             | TSSOP<br>(Pb-Free) | 2000 / Tape & Reel    |
| CAT5241YI-10-T2       | 10              |             |                    |                       |
| CAT5241YI-50-T2       | 50              |             |                    |                       |
| CAT5241YI-00-T2       | 100             |             |                    |                       |
| CAT5241WI25           | 2.5             |             | SOIC<br>(Pb-Free)  | 36 Units / Tube       |
| CAT5241WI10           | 10              |             |                    |                       |
| CAT5241WI50           | 50              |             |                    |                       |
| CAT5241WI00           | 100             |             |                    |                       |
| CAT5241YI25           | 2.5             |             | TSSOP<br>(Pb-Free) | 74 Units / Tube       |
| CAT5241YI10           | 10              |             |                    |                       |
| CAT5241YI50           | 50              |             |                    |                       |
| CAT5241YI00           | 100             |             |                    |                       |

<sup>†</sup>For information on tape and reel specifications, including part orientation and tape sizes, please refer to our Tape and Reel Packaging Specifications Brochure, BRD8011/D.

13. For detailed information and a breakdown of device nomenclature and numbering systems, please see the ON Semiconductor Device Nomenclature document, TND310/D, available at [www.onsemi.com](http://www.onsemi.com).

14. All packages are RoHS-compliant (Lead-free, Halogen-free).

15. The standard lead finish is Matte-Tin.

16. For additional package and temperature options, please contact your nearest ON Semiconductor Sales office.

DISCONTINUED

THIS DEVICE IS NOT RECOMMENDED FOR NEW DESIGN

PLEASE CONTACT YOUR ONSEMI REPRESENTATIVE FOR INFORMATION

**MECHANICAL CASE OUTLINE**  
**PACKAGE DIMENSIONS**



SOIC-20, 300 mils  
CASE 751BJ  
ISSUE O

DATE 19 DEC 2008

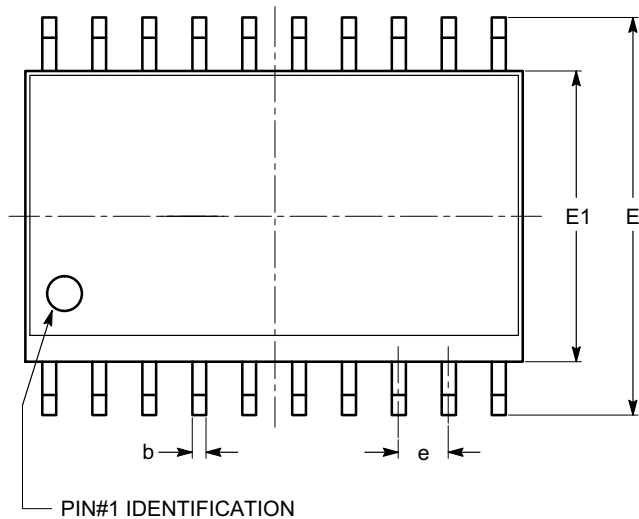

TOP VIEW

| SYMBOL     | MIN      | NOM   | MAX   |
|------------|----------|-------|-------|
| A          | 2.36     | 2.49  | 2.64  |
| A1         | 0.10     |       | 0.30  |
| A2         | 2.05     |       | 2.55  |
| b          | 0.31     | 0.41  | 0.51  |
| c          | 0.20     | 0.27  | 0.33  |
| D          | 12.60    | 12.80 | 13.00 |
| E          | 10.01    | 10.30 | 10.64 |
| E1         | 7.40     | 7.50  | 7.60  |
| e          | 1.27 BSC |       |       |
| h          | 0.25     |       | 0.75  |
| L          | 0.40     | 0.81  | 1.27  |
| $\theta$   | 0°       |       | 8°    |
| $\theta 1$ | 5°       |       | 15°   |

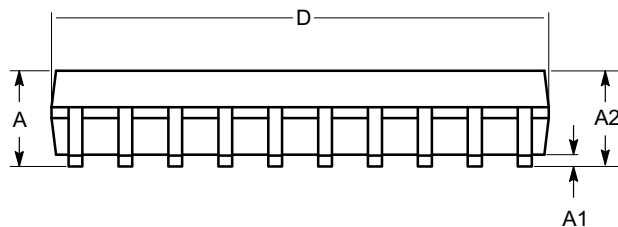

SIDE VIEW

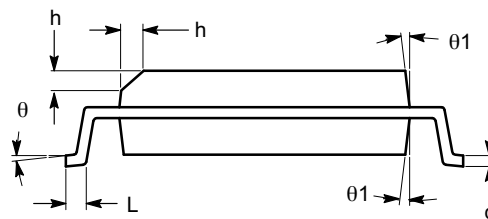

END VIEW

**Notes:**

- (1) All dimensions are in millimeters. Angles in degrees.
- (2) Complies with JEDEC MS-013.

|                         |                          |   |
|-------------------------|--------------------------|---|
| <b>DOCUMENT NUMBER:</b> | <b>98AON34287E</b>       | Electronic versions are uncontrolled except when accessed directly from the Document Repository.<br>Printed versions are uncontrolled except when stamped "CONTROLLED COPY" in red. |
| <b>DESCRIPTION:</b>     | <b>SOIC-20, 300 MILS</b> | <b>PAGE 1 OF 1</b>  |

onsemi and ONSEMI are trademarks of Semiconductor Components Industries, LLC dba onsemi or its subsidiaries in the United States and/or other countries. onsemi reserves the right to make changes without further notice to any products herein. onsemi makes no warranty, representation or guarantee regarding the suitability of its products for any particular purpose, nor does onsemi assume any liability arising out of the application or use of any product or circuit, and specifically disclaims any and all liability, including without limitation special, consequential or incidental damages. onsemi does not convey any license under its patent rights nor the rights of others.

**MECHANICAL CASE OUTLINE**  
**PACKAGE DIMENSIONS**



**TSSOP20, 4.4x6.5**  
**CASE 948AQ**  
**ISSUE A**

DATE 19 MAR 2009

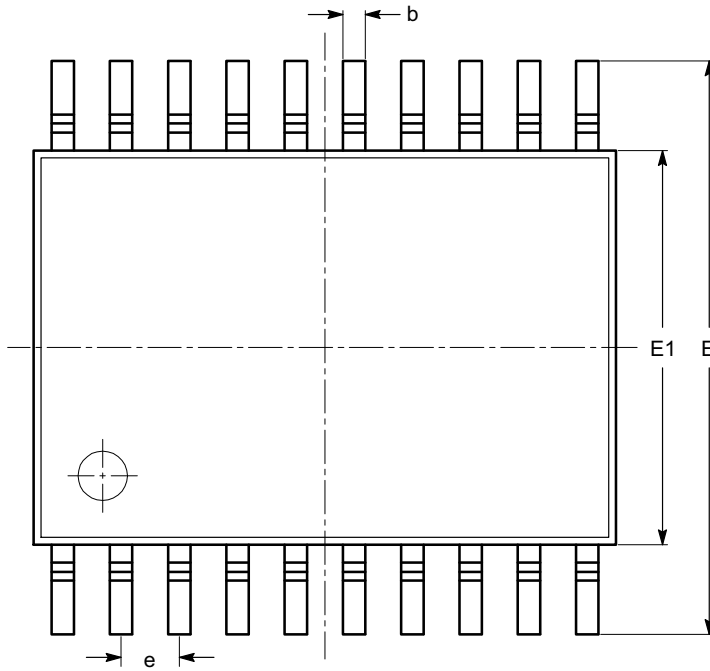

**TOP VIEW**

| SYMBOL   | MIN      | NOM  | MAX  |
|----------|----------|------|------|
| A        |          |      | 1.20 |
| A1       | 0.05     |      | 0.15 |
| A2       | 0.80     |      | 1.05 |
| b        | 0.19     |      | 0.30 |
| c        | 0.09     |      | 0.20 |
| D        | 6.40     | 6.50 | 6.60 |
| E        | 6.30     | 6.40 | 6.50 |
| E1       | 4.30     | 4.40 | 4.50 |
| e        | 0.65 BSC |      |      |
| L        | 0.45     | 0.60 | 0.75 |
| L1       | 1.00 REF |      |      |
| $\theta$ | 0°       |      | 8°   |

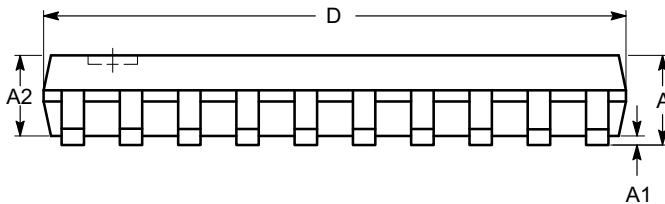

**SIDE VIEW**

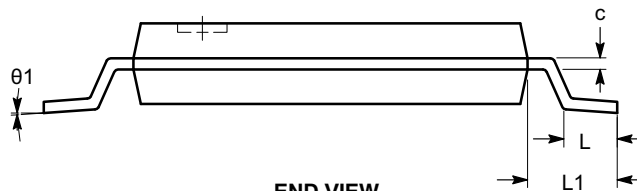

**END VIEW**

**Notes:**

- (1) All dimensions are in millimeters. Angles in degrees.
- (2) Complies with JEDEC MO-153.

|                         |                         |   |
|-------------------------|-------------------------|---|
| <b>DOCUMENT NUMBER:</b> | <b>98AON34453E</b>      | Electronic versions are uncontrolled except when accessed directly from the Document Repository.<br>Printed versions are uncontrolled except when stamped "CONTROLLED COPY" in red. |
| <b>DESCRIPTION:</b>     | <b>TSSOP20, 4.4X6.5</b> | <b>PAGE 1 OF 1</b>  |

onsemi and ONSEMI are trademarks of Semiconductor Components Industries, LLC dba onsemi or its subsidiaries in the United States and/or other countries. onsemi reserves the right to make changes without further notice to any products herein. onsemi makes no warranty, representation or guarantee regarding the suitability of its products for any particular purpose, nor does onsemi assume any liability arising out of the application or use of any product or circuit, and specifically disclaims any and all liability, including without limitation special, consequential or incidental damages. onsemi does not convey any license under its patent rights nor the rights of others.

**onsemi**, **Onsemi**, and other names, marks, and brands are registered and/or common law trademarks of Semiconductor Components Industries, LLC dba "**onsemi**" or its affiliates and/or subsidiaries in the United States and/or other countries. **onsemi** owns the rights to a number of patents, trademarks, copyrights, trade secrets, and other intellectual property. A listing of **onsemi**'s product/patent coverage may be accessed at [www.onsemi.com/site/pdf/Patent-Marking.pdf](http://www.onsemi.com/site/pdf/Patent-Marking.pdf). **onsemi** reserves the right to make changes at any time to any products or information herein, without notice. The information herein is provided "as-is" and **onsemi** makes no warranty, representation or guarantee regarding the accuracy of the information, product features, availability, functionality, or suitability of its products for any particular purpose, nor does **onsemi** assume any liability arising out of the application or use of any product or circuit, and specifically disclaims any and all liability, including without limitation special, consequential or incidental damages. Buyer is responsible for its products and applications using **onsemi** products, including compliance with all laws, regulations and safety requirements or standards, regardless of any support or applications information provided by **onsemi**. "Typical" parameters which may be provided in **onsemi** data sheets and/or specifications can and do vary in different applications and actual performance may vary over time. All operating parameters, including "Typicals" must be validated for each customer application by customer's technical experts. **onsemi** does not convey any license under any of its intellectual property rights nor the rights of others. **onsemi** products are not designed, intended, or authorized for use as a critical component in life support systems or any FDA Class 3 medical devices or medical devices with a same or similar classification in a foreign jurisdiction or any devices intended for implantation in the human body. Should Buyer purchase or use **onsemi** products for any such unintended or unauthorized application, Buyer shall indemnify and hold **onsemi** and its officers, employees, subsidiaries, affiliates, and distributors harmless against all claims, costs, damages, and expenses, and reasonable attorney fees arising out of, directly or indirectly, any claim of personal injury or death associated with such unintended or unauthorized use, even if such claim alleges that **onsemi** was negligent regarding the design or manufacture of the part. **onsemi** is an Equal Opportunity/Affirmative Action Employer. This literature is subject to all applicable copyright laws and is not for resale in any manner.

## ADDITIONAL INFORMATION

### TECHNICAL PUBLICATIONS:

Technical Library: [www.onsemi.com/design/resources/technical-documentation](http://www.onsemi.com/design/resources/technical-documentation)  
onsemi Website: [www.onsemi.com](http://www.onsemi.com)

### ONLINE SUPPORT: [www.onsemi.com/support](http://www.onsemi.com/support)

For additional information, please contact your local Sales Representative at [www.onsemi.com/support/sales](http://www.onsemi.com/support/sales)

## Looking for pricing, stock, or lifecycle information?

Click below to explore more details on WIN SOURCE:

 [View CAT5241WI-10-T1 on WIN SOURCE](#)

 [ON Semiconductor](#) Information

## Optimize Your Supply Chain with WIN SOURCE Solutions

-  Global Sourcing Solution
-  Obsolete Management
-  Cost Control Management
-  Shortage Management
-  Alternative Solution
-  Excess Inventory Management