



**THE DATASHEET OF  
TLV2462QDRG4Q1**



## TLV246xx-Q1 Low-Power Rail-to-Rail Input/Output Operational Amplifiers With Shutdown

### 1 Features

- Qualified for Automotive Applications
- AEC-Q100 Qualified With the Following Results:
  - Device Temperature Grade 1:  $-40^{\circ}\text{C}$  to  $+125^{\circ}\text{C}$  Ambient Operating Temperature Range
  - Device HBM ESD Classification Level 2
  - Device CDM ESD Classification Level C6
- ESD Protection Exceeds 2000 V Per MIL-STD-883, Method 3015; Exceeds 200 V Using Machine Model C = 200 pF, R = 0)
- Rail-to-Rail Output Swing
- Gain Bandwidth Product: 6.4 MHz
- Output Drive Capability:  $\pm 80\text{-mA}$
- Supply Current: 500  $\mu\text{A}/\text{Channel}$
- Input Noise Voltage: 11  $\text{nV}/\sqrt{\text{Hz}}$
- Slew Rate: 1.6  $\text{V}/\mu\text{s}$
- Micropower Shutdown Mode (TLV2460-Q1 and TLV2463-Q1): 0.3  $\mu\text{A}/\text{Channel}$
- Universal Operational Amplifier EVM
- Available in Single, Dual, and Quad Versions

### 2 Applications

- Clusters
- Telematics
- HEV/EV and Powertrains
- DC-to-DC Inverters
- Power Steering
- Lighting Modules
- Battery Management Systems

### 3 Description

The devices in the TLV246x-Q1 family of low-power rail-to-rail input/output operational amplifiers are designed for battery management systems in HEV/EV and Powertrain, and lighting and roof module systems in body and lighting applications. The input common-mode voltage range extends beyond the supply rails for maximum dynamic range in low-voltage systems. The amplifier output has rail-to-rail performance with high-output-drive capability, solving one of the limitations of older rail-to-rail input/output operational amplifiers. This rail-to-rail dynamic range and high output drive make the TLV246x-Q1 designed for buffering analog-to-digital converters.

The operational amplifier has 6.4-MHz bandwidth and a 1.6-V/ $\mu\text{s}$  slew rate with only 500- $\mu\text{A}$  supply current, which provides good ac performance with low-power consumption. Devices are available with an optional shutdown terminal, which places the amplifier in an ultra-low supply-current mode ( $I_{\text{DD}} = 0.3 \mu\text{A}$  per channel). While in shutdown, the operational amplifier output is placed in a high-impedance state. DC applications are designed with an input noise voltage of 11  $\text{nV}/\sqrt{\text{Hz}}$  and input offset voltage of 100  $\mu\text{V}$ .

#### Device Information<sup>(1)</sup>

PART NUMBER	PACKAGE	BODY SIZE (NOM)
TLV246x-Q1, TLV246xA-Q1	TSSOP (8)	4.40 mm x 3.00 mm
TLV2462-Q1, TLV2462A-Q1	SOIC (8)	3.91 mm x 4.90 mm
	TSSOP (8)	4.40 mm x 3.00 mm
	VSSOP (8)	3.00 mm x 3.00 mm
TLV246x-Q1, TLV246xA-Q1	TSSOP (14)	4.40 mm x 5.00 mm

(1) For all available packages, see the orderable addendum at the end of the data sheet.

(2) For all available device options, see the [Mechanical, Packaging, and Orderable Information](#).

#### Typical Application

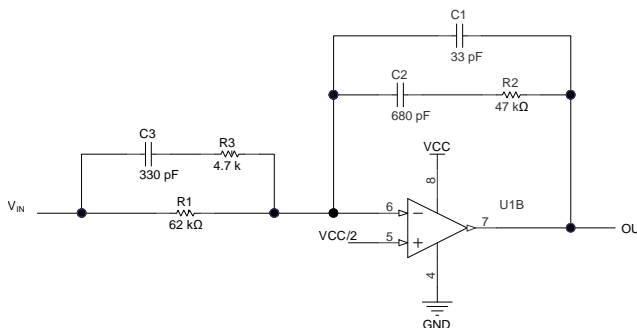

## Table of Contents

<b>1 Features</b> .....	<b>1</b>	<b>8 Detailed Description</b> .....	<b>22</b>
<b>2 Applications</b> .....	<b>1</b>	8.1 Overview .....	22
<b>3 Description</b> .....	<b>1</b>	8.2 Functional Block Diagram .....	22
<b>4 Revision History</b> .....	<b>2</b>	8.3 Feature Description .....	22
<b>5 Pin Configuration and Functions</b> .....	<b>4</b>	8.4 Device Functional Modes .....	25
<b>6 Specifications</b> .....	<b>6</b>	<b>9 Application and Implementation</b> .....	<b>26</b>
6.1 Absolute Maximum Ratings .....	6	9.1 Application Information .....	26
6.2 ESD Ratings .....	6	9.2 Typical Application .....	28
6.3 Recommended Operating Conditions .....	6	<b>10 Power Supply Recommendations</b> .....	<b>30</b>
6.4 Thermal Information: TLV2460x-Q1 .....	6	<b>11 Layout</b> .....	<b>31</b>
6.5 Thermal Information: TLV2461x-Q1 .....	7	11.1 Layout Guidelines .....	31
6.6 Thermal Information: TLV2462-Q1 .....	7	11.2 Layout Example .....	31
6.7 Thermal Information: TLV2462A-Q1 .....	7	<b>12 Device and Documentation Support</b> .....	<b>32</b>
6.8 Thermal Information: TLV2463x-Q1 .....	7	12.1 Documentation Support .....	32
6.9 Electrical Characteristics: $V_{DD} = 3\text{ V}$ .....	8	12.2 Related Links .....	32
6.10 Electrical Characteristics: $V_{DD} = 5\text{ V}$ .....	9	12.3 Community Resources .....	32
6.11 Operating Characteristics: $V_{DD} = 3\text{ V}$ .....	11	12.4 Trademarks .....	32
6.12 Operating Characteristics: $V_{DD} = 5\text{ V}$ .....	12	12.5 Electrostatic Discharge Caution .....	32
6.13 Typical Characteristics .....	13	12.6 Glossary .....	32
<b>7 Parameter Measurement Information</b> .....	<b>22</b>	<b>13 Mechanical, Packaging, and Orderable Information</b> .....	<b>33</b>

## 4 Revision History

NOTE: Page numbers for previous revisions may differ from page numbers in the current version.

Changes from Revision F (December 2015) to Revision G	Page
• Updated data sheet text to latest data sheet and translation standards .....	1
• Deleted "Input Offset Voltage: 100 $\mu\text{V}$ " bullet from <i>Features</i> section .....	1
• Deleted "Universal Operational Amplifier EVM" bullet from <i>Features</i> section .....	1
• Deleted TLV2464 device from document .....	1
• Deleted <i>Device Comparison</i> table .....	4
• Reformatted <i>Thermal Information</i> tables and table notes .....	6
• Changed $I_{IO}$ and $I_{IB}$ unit from pA to nA in <i>Electrical Characteristics: <math>V_{DD} = 3\text{ V}</math></i> table .....	8
• Changed $I_{IO}$ and $I_{IB}$ unit from pA to nA in <i>Electrical Characteristics: <math>V_{DD} = 5\text{ V}</math></i> table .....	9
• Reformatted document references in <i>Related Documentation</i> section .....	32

Changes from Revision E (October 2012) to Revision F	Page
• Added AEC-Q100 bulleted items .....	1
• Added <i>ESD Ratings</i> table, <i>Feature Description</i> section, <i>Device Functional Modes</i> , <i>Application and Implementation</i> section, <i>Power Supply Recommendations</i> section, <i>Layout</i> section, <i>Device and Documentation Support</i> section, and <i>Mechanical, Packaging, and Orderable Information</i> section .....	1
• Deleted D package from TLV2460-Q1, TLV2461-Q1, TLV2463-Q1, and TLV2464A-Q1 and added TLV246xA-Q1 device number to pin drawings .....	4
• Deleted table note 3 reference to JESD 51-5 from <i>Absolute Maximum Ratings</i> table .....	6

---

<b>Changes from Revision D (September 2010) to Revision E</b>	<b>Page</b>
• Changed device names from TLV246xx to TLV246xx-Q1 throughout document.....	<b>1</b>
• Changed $I_{DD}$ unit from $\mu A$ to mA. ....	<b>8</b>
• Changed $I_{DD}$ unit from $\mu A$ to mA .....	<b>9</b>

---

## 5 Pin Configuration and Functions

TLV2460-Q1, TLV2460A-Q1 PW Package  
8-Pin TSSOP  
Top View

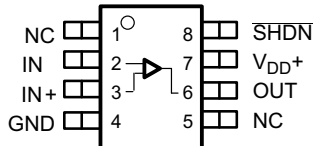

NC- no internal connection

TLV2461-Q1, TLV2461A-Q1 PW Package  
8-Pin TSSOP  
Top View

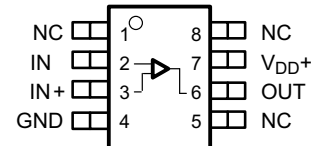

NC- no internal connection

TLV2462-Q1, TLV2462A-Q1 D, DGK, or PW Package  
8-Pin SOIC, TSSOP, or VSSOP  
Top View

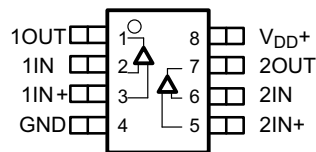

NC – No internal connection

### Pin Functions

NAME	PIN			I/O	DESCRIPTION
	TLV2460-Q1, TLV2460A-Q1	TLV2461-Q1, TLV2461A-Q1	TLV2462-Q1, TLV2462A-Q1		
1IN	—	—	2	I	Inverting input, channel 1
1IN+	—	—	3	I	Noninverting input, channel 1
1OUT	—	—	1	O	Output, channel 1
2IN	—	—	6	I	Inverting input, channel 2
2IN+	—	—	5	I	Noninverting input, channel 2
2OUT	—	—	7	O	Output, channel 2
IN	2	2	—	I	Inverting input
IN+	3	3	—	I	Noninverting input
GND	4	4	4	—	Negative (lowest) supply
NC	1, 5	1, 5, 8	—	—	No internal connection
OUT	6	6	—	O	Output
SHDN	8	—	—	I	Shutdown
V <sub>DD+</sub>	7	7	8	—	Positive (highest) supply

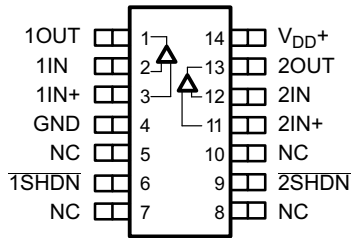
**TLV2463-Q1, TLV2463A-Q1 PW Package  
14-Pin TSSOP  
Top View**

NC – No internal connection

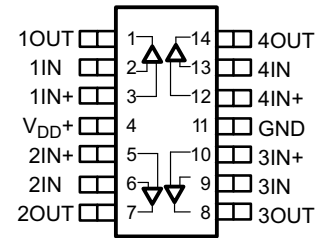
**TLV2463-Q1, TLV2463A-Q1 PW Package  
14-Pin TSSOP  
Top View**

### Pin Functions

NAME	PIN		I/O	DESCRIPTION
	TLV2463-Q1, TLV2463A-Q1	TLV2464A-Q1		
1IN	2	2	I	Inverting input, channel 1
1IN+	3	3	I	Noninverting input, channel 1
1OUT	1	1	O	Output, channel 1
1SHDN	6	—	I	Shutdown for channel 1
2IN	12	6	I	Inverting input, channel 2
2IN+	11	5	I	Noninverting input, channel 2
2OUT	13	7	O	Output, channel 2
2SHDN	9	—	I	Shutdown for channel 2
3IN	—	9	I	Inverting input, channel 3
3IN+	—	10	I	Noninverting input, channel 3
3OUT	—	8	O	Output, channel 3
4IN	—	13	I	Inverting input, channel 4
4IN+	—	12	I	Noninverting input, channel 4
4OUT	—	14	O	Output, channel 4
IN	—	—	I	Inverting input
IN+	—	—	I	Noninverting input
GND	4	11	—	Negative (lowest) supply
NC	5, 7, 8, 10	—	—	No internal connection
OUT	—	—	O	Output
SHDN	—	—	I	Shutdown
V <sub>DD</sub> +	14	4	—	Positive (highest) supply

## 6 Specifications

### 6.1 Absolute Maximum Ratings

over operating free-air temperature range (unless otherwise noted) <sup>(1)</sup>

	MIN	MAX	UNIT
Supply voltage <sup>(2)</sup> , V <sub>DD</sub>		6	V
Differential input voltage, V <sub>ID</sub>	-0.2	V <sub>DD</sub> + 0.2	V
Input current (any input), I <sub>I</sub>	-200	200	mA
Output current, I <sub>O</sub>	-175	175	mA
Total input current (into V <sub>DD+</sub> ), I <sub>I</sub>		175	mA
Total output current (out of GND), I <sub>O</sub>		175	mA
Operating free-air temperature, T <sub>A</sub>	-40	125	°C
Maximum junction temperature, T <sub>J</sub>		150	°C
Lead temperature 1.6 mm (1/16 inch) from case for 10 seconds		260	°C
Storage temperature, T <sub>stg</sub>	-65	150	°C

- (1) Stresses beyond those listed under *Absolute Maximum Ratings* may cause permanent damage to the device. These are stress ratings only, which do not imply functional operation of the device at these or any other conditions beyond those indicated under *Recommended Operating Conditions*. Exposure to absolute-maximum-rated conditions for extended periods may affect device reliability.
- (2) All voltage values, except differential voltages, are with respect to GND.

### 6.2 ESD Ratings

		VALUE	UNIT
V <sub>(ESD)</sub>	Electrostatic discharge	Human-body model (HBM), per AEC Q100-002 <sup>(1)</sup>	±2000
		Charged-device model (CDM), per AEC Q100-011	±1000

- (1) AEC Q100-002 indicates that HBM stressing shall be in accordance with the ANSI/ESDA/JEDEC JS-001 specification.

### 6.3 Recommended Operating Conditions

		MIN	MAX	UNIT
V <sub>DD</sub>	Supply voltage	Single-supply	2.7	6
		Split-supply	±1.35	±3
V <sub>ICR</sub>	Common-mode input voltage range <sup>(1)</sup>	-0.2	V <sub>DD</sub> + 0.2	V
T <sub>A</sub>	Operating free-air temperature	-40	125	°C
	Shutdown on and off voltage level <sup>(1)</sup>	V <sub>IH</sub>	2	V
		V <sub>IL</sub>	0.7	

- (1) Relative to voltage on the GND terminal of the device

### 6.4 Thermal Information: TLV2460x-Q1

THERMAL METRIC <sup>(1)</sup>		TLV2460x-Q1	UNIT
		PW (TSSOP)	
		8 PINS	
R <sub>θJA</sub>	Junction-to-ambient thermal resistance	185.7	°C/W
R <sub>θJC(top)</sub>	Junction-to-case (top) thermal resistance	69	°C/W
R <sub>θJB</sub>	Junction-to-board thermal resistance	114.5	°C/W
ψ <sub>JT</sub>	Junction-to-top characterization parameter	9.6	°C/W
ψ <sub>JB</sub>	Junction-to-board characterization parameter	112.7	°C/W
R <sub>θJC(bot)</sub>	Junction-to-case (bottom) thermal resistance	N/A	°C/W

- (1) For more information about traditional and new thermal metrics, see the *Semiconductor and IC Package Thermal Metrics* application report.

## 6.5 Thermal Information: TLV2461x-Q1

THERMAL METRIC <sup>(1)</sup>		TLV2461x-Q1	
		PW (TSSOP)	
		8 PINS	
			UNIT
$R_{\theta JA}$	Junction-to-ambient thermal resistance	185.7	°C/W
$R_{\theta JC(top)}$	Junction-to-case (top) thermal resistance	69	°C/W
$R_{\theta JB}$	Junction-to-board thermal resistance	114.5	°C/W
$\Psi_{JT}$	Junction-to-top characterization parameter	9.6	°C/W
$\Psi_{JB}$	Junction-to-board characterization parameter	112.7	°C/W
$R_{\theta JC(bot)}$	Junction-to-case (bottom) thermal resistance	N/A	°C/W

(1) For more information about traditional and new thermal metrics, see the [Semiconductor and IC Package Thermal Metrics](#) application report.

## 6.6 Thermal Information: TLV2462-Q1

THERMAL METRIC <sup>(1)</sup>		TLV2462-Q1			UNIT
		D (SOIC)	DGK (VSSOP)	PW (TSSOP)	
		8 PINS	8 PINS	8 PINS	
$R_{\theta JA}$	Junction-to-ambient thermal resistance	120.1	179.3	183.6	°C/W
$R_{\theta JC(top)}$	Junction-to-case (top) thermal resistance	68.3	71.1	67	°C/W
$R_{\theta JB}$	Junction-to-board thermal resistance	60.4	100.4	112.3	°C/W
$\Psi_{JT}$	Junction-to-top characterization parameter	20.6	10.7	9	°C/W
$\Psi_{JB}$	Junction-to-board characterization parameter	59.9	98.8	110.6	°C/W
$R_{\theta JC(bot)}$	Junction-to-case (bottom) thermal resistance	N/A	N/A	N/A	°C/W

(1) For more information about traditional and new thermal metrics, see the [Semiconductor and IC Package Thermal Metrics](#) application report.

## 6.7 Thermal Information: TLV2462A-Q1

THERMAL METRIC <sup>(1)</sup>		TLV2462A-Q1		UNIT
		D (SOIC)	PW (TSSOP)	
		8 PINS	8 PINS	
$R_{\theta JA}$	Junction-to-ambient thermal resistance	120.1	185.7	°C/W
$R_{\theta JC(top)}$	Junction-to-case (top) thermal resistance	68.3	69	°C/W
$R_{\theta JB}$	Junction-to-board thermal resistance	60.4	114.5	°C/W
$\Psi_{JT}$	Junction-to-top characterization parameter	20.6	9.6	°C/W
$\Psi_{JB}$	Junction-to-board characterization parameter	59.9	112.7	°C/W
$R_{\theta JC(bot)}$	Junction-to-case (bottom) thermal resistance	N/A	N/A	°C/W

(1) For more information about traditional and new thermal metrics, see the [Semiconductor and IC Package Thermal Metrics](#) application report.

## 6.8 Thermal Information: TLV2463x-Q1

THERMAL METRIC <sup>(1)</sup>		TLV2463x-Q1	
		PW (TSSOP)	
		8 PINS	
			UNIT
$R_{\theta JA}$	Junction-to-ambient thermal resistance	185.7	°C/W
$R_{\theta JC(top)}$	Junction-to-case (top) thermal resistance	69	°C/W
$R_{\theta JB}$	Junction-to-board thermal resistance	114.5	°C/W
$\Psi_{JT}$	Junction-to-top characterization parameter	9.6	°C/W
$\Psi_{JB}$	Junction-to-board characterization parameter	112.7	°C/W
$R_{\theta JC(bot)}$	Junction-to-case (bottom) thermal resistance	N/A	°C/W

(1) For more information about traditional and new thermal metrics, see the [Semiconductor and IC Package Thermal Metrics](#) application report.

## 6.9 Electrical Characteristics: $V_{DD} = 3\text{ V}$

at specified free-air temperature,  $V_{DD} = 3\text{ V}$ , (unless otherwise noted)

PARAMETER		TEST CONDITIONS		MIN	TYP	MAX	UNIT
$V_{IO}$	Input offset voltage	$V_{DD} = 3\text{ V}$ $V_{IC} = 1.5\text{ V}$ $V_O = 1.5\text{ V}$ $R_S = 50\ \Omega$	TLV246x-Q1	$T_A = 25^\circ\text{C}$	100	2000	$\mu\text{V}$
				Full range <sup>(1)</sup>		2200	
			TLV246xA-Q1	$T_A = 25^\circ\text{C}$	150	1500	
				Full range <sup>(1)</sup>		1700	
$\alpha_{VIO}$	Temperature coefficient of input offset voltage	$V_{DD} = 3\text{ V}$ $V_{IC} = 1.5\text{ V}$ $V_O = 1.5\text{ V}$ $R_S = 50\ \Omega$			2	$\mu\text{V}/^\circ\text{C}$	
$I_{IO}$	Input offset current	$V_{DD} = 3\text{ V}$ $V_{IC} = 1.5\text{ V}$ $V_O = 1.5\text{ V}$ $R_S = 50\ \Omega$	$T_A = 25^\circ\text{C}$		2.8	7	nA
			Full range <sup>(1)</sup>			75	
$I_{IB}$	Input bias current	$V_{IC} = 1.5\text{ V}$ $V_O = 1.5\text{ V}$ $R_S = 50\ \Omega$	$T_A = 25^\circ\text{C}$		4.4	14	nA
			Full range <sup>(1)</sup>			75	
$V_{OH}$	High-level output voltage	$I_O = -2.5\text{ mA}$	$T_A = 25^\circ\text{C}$			2.9	V
			Full range <sup>(1)</sup>		2.8		
			$T_A = 25^\circ\text{C}$			2.7	
$V_{OL}$	Low-level output voltage	$V_{IC} = 1.5\text{ V}$ $I_{OL} = 2.5\text{ mA}$	$T_A = 25^\circ\text{C}$			0.1	V
			Full range <sup>(1)</sup>			0.2	
			$V_{IC} = 1.5\text{ V}$ $I_{OL} = 10\text{ mA}$	$T_A = 25^\circ\text{C}$			
$I_{OS}$	Short circuit output current	Sourcing	$T_A = 25^\circ\text{C}$			50	mA
			Full range <sup>(1)</sup>		20		
			$T_A = 25^\circ\text{C}$			40	
$I_O$	Output current	Measured 1 V from rail	$T_A = 25^\circ\text{C}$			$\pm 40$	mA
			Full range <sup>(1)</sup>				
			$T_A = 25^\circ\text{C}$			20	
$A_{VD}$	Large-signal differential voltage amplification	$R_L = 10\text{ k}\Omega$	$T_A = 25^\circ\text{C}$		90	105	dB
			Full range <sup>(1)</sup>		89		
$r_{i(d)}$	Differential input resistance		$T_A = 25^\circ\text{C}$			$10^9$	$\Omega$
$c_{i(o)}$	Common-mode input capacitance	$f = 10\text{ kHz}$	$T_A = 25^\circ\text{C}$			7	pF
$z_o$	Closed-loop output impedance	$f = 100\text{ kHz}$ $A_V = 10$	$T_A = 25^\circ\text{C}$			33	$\Omega$
CMRR	Common-mode rejection ratio	$V_{ICR} = 0\text{ V to } 3\text{ V}$ $R_S = 50\ \Omega$	$T_A = 25^\circ\text{C}$		66	80	dB
			Full range <sup>(1)</sup>		60		
$k_{SVR}$	Supply-voltage rejection ratio ( $\Delta V_{DD\pm} / \Delta V_{IO}$ )	$V_{DD} = 2.7\text{ V to } 6\text{ V}$ $V_{IC} = V_{DD} / 2$ ; no load	$T_A = 25^\circ\text{C}$		80	85	dB
			Full range <sup>(1)</sup>		75		
			$T_A = 25^\circ\text{C}$		85	95	
			Full range <sup>(1)</sup>		80		
$I_{DD}$	Supply current (per channel)	$V_O = 1.5\text{ V}$ ; no load	$T_A = 25^\circ\text{C}$		0.5	0.575	mA
			Full range <sup>(1)</sup>			0.9	
$I_{DD(SHDN)}$	Supply current in shutdown (TLV2460-Q1, TLV2463-Q1)	$\overline{\text{SHDN}} < 0.7\text{ V}$ , per channel in shutdown	$T_A = 25^\circ\text{C}$		0.3		$\mu\text{A}$
			Full range <sup>(1)</sup>			2.5	

(1) Full range is  $-40^\circ\text{C}$  to  $+125^\circ\text{C}$ .

## 6.10 Electrical Characteristics: $V_{DD} = 5\text{ V}$

 at specified free-air temperature,  $V_{DD} = 5\text{ V}$ , (unless otherwise noted)

PARAMETER		TEST CONDITIONS		MIN	TYP	MAX	UNIT
$V_{IO}$	Input offset voltage	$V_{DD} = 5\text{ V}$ $V_{IC} = 2.5\text{ V}$ $V_O = 2.5\text{ V}$ $R_S = 50\ \Omega$	TLV246x-Q1	$T_A = 25^\circ\text{C}$	150	2000	$\mu\text{V}$
				Full range <sup>(1)</sup>		2200	
		TLV246xA-Q1	$T_A = 25^\circ\text{C}$		150	1500	
			Full range <sup>(1)</sup>			1700	
$\alpha_{VIO}$	Temperature coefficient of input offset voltage	$V_{DD} = 5\text{ V}$ $V_{IC} = 2.5\text{ V}$ $V_O = 2.5\text{ V}$ $R_S = 50\ \Omega$			2		$\mu\text{V}/^\circ\text{C}$
$I_{IO}$	Input offset current	$V_{DD} = 5\text{ V}$ $V_{IC} = 2.5\text{ V}$ $V_O = 2.5\text{ V}$ $R_S = 50\ \Omega$	$T_A = 25^\circ\text{C}$		0.3	7	nA
			Full range <sup>(1)</sup>				
$I_{IB}$	Input bias current	$V_{DD} = 5\text{ V}$ $V_{IC} = 2.5\text{ V}$ $V_O = 2.5\text{ V}$ $R_S = 50\ \Omega$	$T_A = 25^\circ\text{C}$		1.3	14	nA
			Full range <sup>(1)</sup>				
$V_{OH}$	High-level output voltage	$I_O = -2.5\text{ mA}$		$T_A = 25^\circ\text{C}$		4.9	V
				Full range <sup>(1)</sup>			
		$I_O = -10\text{ mA}$	TLV246x-Q1, TLV246xA-Q1	$T_A = 25^\circ\text{C}$		4.8	
				Full range <sup>(1)</sup>			
TLV2462QDGKRQ1	$T_A = 25^\circ\text{C}$		4.8				
	Full range <sup>(1)</sup>			4.4			
$V_{OL}$	Low-level output voltage	$V_{IC} = 2.5\text{ V}$ $I_{OL} = 2.5\text{ mA}$		$T_A = 25^\circ\text{C}$		0.1	V
				Full range <sup>(1)</sup>			
		$V_{IC} = 2.5\text{ V}$ $I_{OL} = 10\text{ mA}$	$T_A = 25^\circ\text{C}$		0.2		
			Full range <sup>(1)</sup>			0.3	
$I_{OS}$	Short circuit output current	Sourcing		$T_A = 25^\circ\text{C}$		145	mA
				Full range <sup>(1)</sup>			
		Sinking	$T_A = 25^\circ\text{C}$		100		
			Full range <sup>(1)</sup>			60	
$I_O$	Output current	Measured 1 V from rail	$T_A = 25^\circ\text{C}$		$\pm 80$		mA
$A_{VD}$	Large-signal differential voltage amplification	$V_{IC} = 2.5\text{ V}$ $R_L = 10\text{ k}\Omega$ $V_O = 1\text{ V to }4\text{ V}$		$T_A = 25^\circ\text{C}$	92	109	dB
				Full range <sup>(1)</sup>		90	
$r_{i(d)}$	Differential input resistance			$T_A = 25^\circ\text{C}$		$10^9$	$\Omega$
$C_{i(o)}$	Common-mode input capacitance	$f = 10\text{ kHz}$		$T_A = 25^\circ\text{C}$		7	pF
$Z_o$	Closed-loop output impedance	$f = 100\text{ kHz}, A_V = 10$		$T_A = 25^\circ\text{C}$		29	$\Omega$
CMRR	Common-mode rejection ratio	$V_{ICR} = 0\text{ V to }5\text{ V}$ $R_S = 50\ \Omega$		$T_A = 25^\circ\text{C}$	71	85	dB
				Full range <sup>(1)</sup>		60	
$k_{SVR}$	Supply-voltage rejection ratio ( $\Delta V_{DD\pm} / \Delta V_{IO}$ )	$V_{DD} = 2.7\text{ V to }6\text{ V}$ $V_{IC} = V_{DD} / 2$ ; no load		$T_A = 25^\circ\text{C}$	80	85	dB
				Full range <sup>(1)</sup>		75	
		$V_{DD} = 3\text{ V to }5\text{ V}$ $V_{IC} = V_{DD} / 2$ ; no load	$T_A = 25^\circ\text{C}$	85	95		
			Full range <sup>(1)</sup>		80		
$I_{DD}$	Supply current (per channel)	$V_O = 2.5\text{ V}$ ; no load		$T_A = 25^\circ\text{C}$	0.55	0.65	mA
				Full range <sup>(1)</sup>			

 (1) Full range is  $-40^\circ\text{C}$  to  $+125^\circ\text{C}$ .

**Electrical Characteristics:  $V_{DD} = 5\text{ V}$  (continued)**

at specified free-air temperature,  $V_{DD} = 5\text{ V}$ , (unless otherwise noted)

PARAMETER		TEST CONDITIONS		MIN	TYP	MAX	UNIT
$I_{DD(SHD)}$ N)	Supply current in shutdown (TLV2460-Q1, TLV2463-Q1)	$\overline{SHDN} < 0.7\text{ V}$ , Per channel in shutdown	$T_A = 25^\circ\text{C}$		1		$\mu\text{A}$
			Full range <sup>(1)</sup>			3	

## 6.11 Operating Characteristics: $V_{DD} = 3\text{ V}$

$V_{DD} = 3\text{ V}$ , at specified free-air temperature (unless otherwise noted)

PARAMETER		TEST CONDITIONS		MIN	TYP	MAX	UNIT
SR	Slew rate at unity gain	$V_{O(PP)} = 2\text{ V}$ $C_L = 160\text{ pF}$ $R_L = 10\text{ k}\Omega$	$T_A = 25^\circ\text{C}$	1	1.6		$\text{V}/\mu\text{s}$
			Full range <sup>(1)</sup>	0.8			
$V_n$	Equivalent input noise voltage	$f = 100\text{ Hz}$ $f = 1\text{ kHz}$	$T_A = 25^\circ\text{C}$		16		$\text{nV}/\sqrt{\text{Hz}}$
					11		
$I_n$	Equivalent input noise current	$f = 1\text{ kHz}$	$T_A = 25^\circ\text{C}$		0.13		$\text{pA}/\sqrt{\text{Hz}}$
THD + N	Total harmonic distortion plus noise	$V_{O(PP)} = 2\text{ V}$ $R_L = 10\text{ k}\Omega$ , $f = 1\text{ kHz}$	$A_V = 1$	$T_A = 25^\circ\text{C}$	0.006%		
			$A_V = 10$		0.02%		
			$A_V = 100$		0.08%		
$t_{(on)}$	Amplifier turn-on time	$A_V = 1$ $R_L = 10\text{ k}\Omega$	Both channels	$T_A = 25^\circ\text{C}$	7.6		$\mu\text{s}$
			Channel 1 only, Channel 2 on		7.65		
$t_{(off)}$	Amplifier turn-off time	$A_V = 1$ $R_L = 10\text{ k}\Omega$	Both channels	$T_A = 25^\circ\text{C}$	333		ns
			Channel 1 only, Channel 2 on		328		
			Channel 2 only, Channel 1 on		329		
Gain-bandwidth product		$f = 10\text{ kHz}$ $C_L = 160\text{ pF}$ $R_L = 10\text{ k}\Omega$	$T_A = 25^\circ\text{C}$		5.2		MHz
$t_s$	Settling time	$V_{(STEP)PP} = 2\text{ V}$ $A_V = -1$ $C_L = 10\text{ pF}$ $R_L = 10\text{ k}\Omega$	0.1%	$T_A = 25^\circ\text{C}$	1.47		$\mu\text{s}$
			0.01%		1.78		
		$V_{(STEP)PP} = 2\text{ V}$ $A_V = -1$ $C_L = 56\text{ pF}$ $R_L = 10\text{ k}\Omega$	0.1%		1.77		
			0.01%		1.98		
$\phi_m$	Phase margin at unity gain	$R_L = 10\text{ k}\Omega$ $C_L = 160\text{ pF}$	$T_A = 25^\circ\text{C}$		44		$^\circ$
Gain margin		$R_L = 10\text{ k}\Omega$ $C_L = 160\text{ pF}$	$T_A = 25^\circ\text{C}$		7		dB

(1) Full range is  $-40^\circ\text{C}$  to  $+125^\circ\text{C}$ .

## 6.12 Operating Characteristics: $V_{DD} = 5\text{ V}$

$V_{DD} = 5\text{ V}$ , at specified free-air temperature, (unless otherwise noted)

PARAMETER		TEST CONDITIONS		MIN	TYP	MAX	UNIT	
SR	Slew rate at unity gain	$V_{O(PP)} = 2\text{ V}$ $C_L = 160\text{ pF}$ $R_L = 10\text{ k}\Omega$	$T_A = 25^\circ\text{C}$	1	1.6		V/ $\mu\text{s}$	
			Full range <sup>(1)</sup>	0.8				
$V_n$	Equivalent input noise voltage	$f = 100\text{ Hz}$ $f = 1\text{ kHz}$	$T_A = 25^\circ\text{C}$		14		nV/ $\sqrt{\text{Hz}}$	
					11			
$I_n$	Equivalent input noise current	$f = 100\text{ Hz}$	$T_A = 25^\circ\text{C}$		0.13		pA/ $\sqrt{\text{Hz}}$	
THD + N	Total harmonic distortion plus noise	$V_{O(PP)} = 4\text{ V}$ $R_L = 10\text{ k}\Omega$ $f = 10\text{ kHz}$	$T_A = 25^\circ\text{C}$	$A_V = 1$	0.004%			
				$A_V = 10$	0.01%			
				$A_V = 100$	0.04%			
$t_{(on)}$	Amplifier turn-on time	$A_V = 1\ R_L = 10\text{ k}\Omega$	$T_A = 25^\circ\text{C}$	Both channels	7.6		$\mu\text{s}$	
				Channel 1 only, Channel 2 on	7.65			
				Channel 2 only, Channel 1 on	7.25			
$t_{(off)}$	Amplifier turn-off time	$A_V = 1\ R_L = 10\text{ k}\Omega$	$T_A = 25^\circ\text{C}$	Both channels	333		ns	
				Channel 1 only, Channel 2 on	328			
				Channel 2 only, Channel 1 on	329			
	Gain-bandwidth product	$f = 10\text{ kHz}$ $C_L = 160\text{ pF}$ $R_L = 10\text{ k}\Omega$	$T_A = 25^\circ\text{C}$		6.4		MHz	
$t_s$	Settling time	$V_{(STEP)PP} = 2\text{ V}$ $A_V = -1$ $C_L = 10\text{ pF}$ $R_L = 10\text{ k}\Omega$	$T_A = 25^\circ\text{C}$	0.1%	1.53		$\mu\text{s}$	
				0.01%	1.83			
				$V_{(STEP)PP} = 2\text{ V}$ $A_V = -1$ $C_L = 56\text{ pF}$ $R_L = 10\text{ k}\Omega$	0.1%	3.13		
				0.01%	3.33			
$\phi_m$	Phase margin at unity gain	$R_L = 10\text{ k}\Omega$ $C_L = 160\text{ pF}$	$T_A = 25^\circ\text{C}$		45		$^\circ$	
	Gain margin	$R_L = 10\text{ k}\Omega$ $C_L = 160\text{ pF}$	$T_A = 25^\circ\text{C}$		7		dB	

(1) Full range is  $-40^\circ\text{C}$  to  $+125^\circ\text{C}$ .

## 6.13 Typical Characteristics

CONDITION STATEMENT TBD

**Table 1. Table of Graphs**

GRAPH TITLE		FIGURE
$V_{IO}$	Input offset voltage vs common-mode input voltage	1, 2
$I_{IB}$	Input bias current vs free-air temperature	3, 4
$I_{IO}$	Input offset current vs free-air temperature	3, 4
$V_{OH}$	High-level output voltage vs high-level output current	5, 6
$V_{OL}$	Low-level output voltage vs low-level output current	7, 8
$V_{O(PP)}$	Maximum peak-to-peak output voltage vs frequency	9, 10
	Open-loop gain vs frequency	11, 12
	Phase vs frequency	11, 12
$A_{VD}$	Differential voltage amplification vs load resistance	13
	Capacitive load vs load resistance	14
$z_o$	Output impedance vs frequency	15, 16
CMRR	Common-mode rejection ratio vs frequency	17
$k_{SVR}$	Supply-voltage rejection ratio vs frequency	18, 19
$I_{DD}$	Supply current vs supply voltage	20
	Supply current vs free-air temperature	21
	Amplifier turnon characteristics	22
	Amplifier turnoff characteristics	23
	Supply current turnon	24
	Supply current turnoff	25
	Shutdown supply current vs free-air temperature	26
	SR	Slew rate vs load capacitance
$V_n$	Equivalent input noise voltage vs frequency	28, 29
	Equivalent input noise voltage vs common-mode input voltage	30, 31
THD	Total harmonic distortion vs frequency	32, 33
THD + N	Total harmonic distortion plus noise vs peak-to-peak signal amplitude	34, 35
$\phi_m$	Phase margin vs frequency	11, 12
	Phase margin vs load capacitance	36
	Phase margin vs free-air temperature	37
	Gain-bandwidth product vs supply voltage	38
	Gain-bandwidth product vs free-air temperature	39
	Large signal follower	40, 41
	Small signal follower	42, 43
	Inverting large signal	44, 45
	Inverting small signal	46, 47

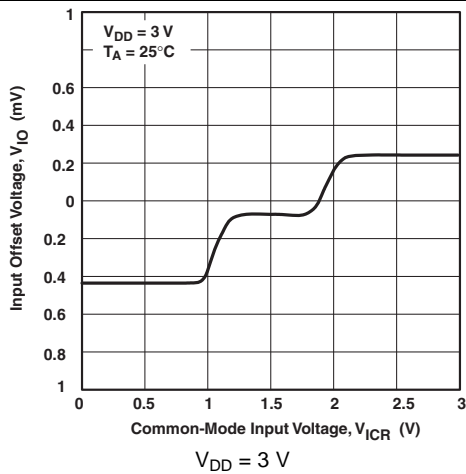

**Figure 1. Input Offset Voltage vs Common-Mode Input Voltage**

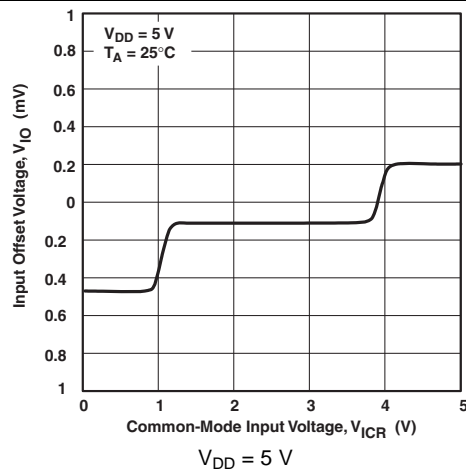

**Figure 2. Input Offset Voltage vs Common-Mode Input Voltage**

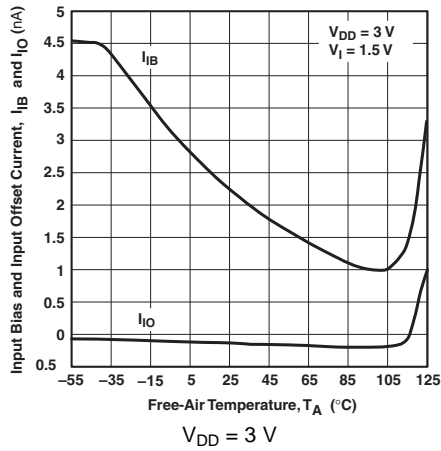

**Figure 3. Input Bias and Input Offset Current vs Free-Air Temperature**

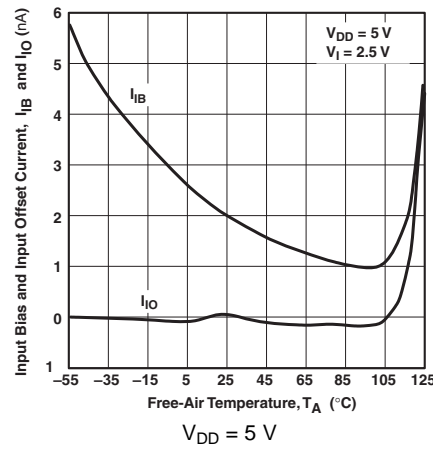

**Figure 4. Input Bias and Input Offset Current vs Free-Air Temperature**

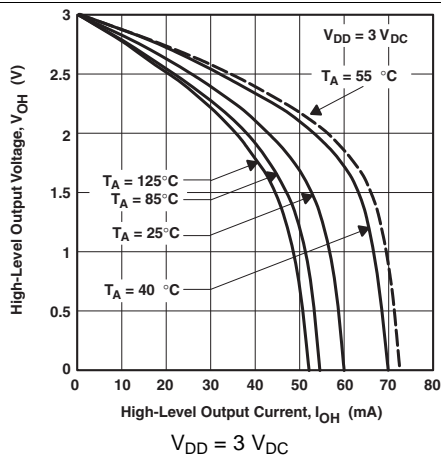

**Figure 5. High-Level Output Voltage vs High-Level Output Current**

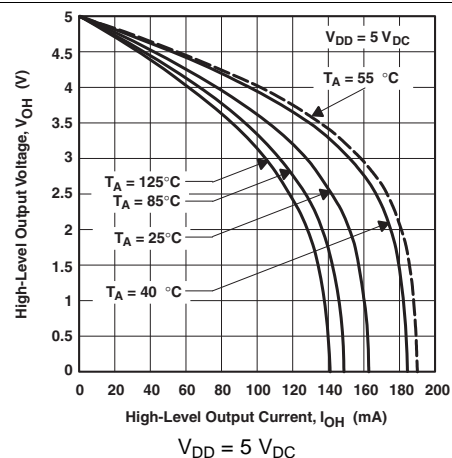

**Figure 6. High-Level Output Voltage vs High-Level Output Current**

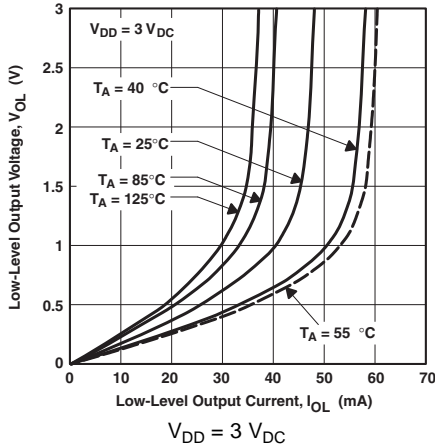

Figure 7. Low-Level Output Voltage vs Low-Level Output Current

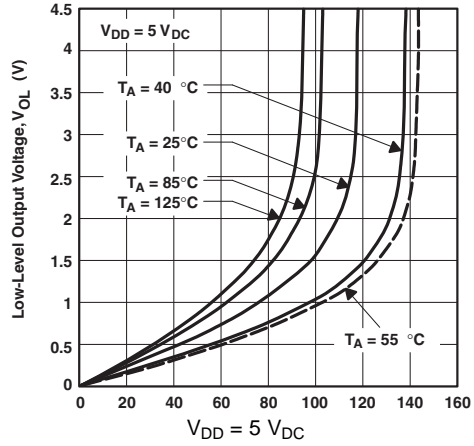

Figure 8. Low-level Output Voltage vs Low-Level Output Current

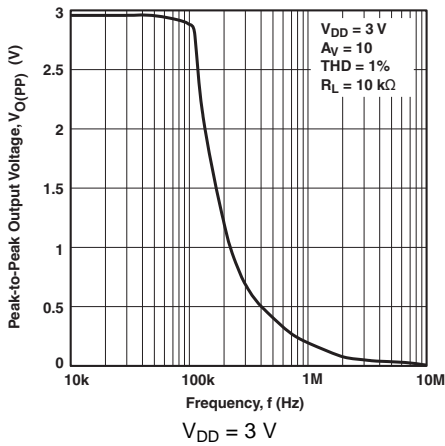

Figure 9. Peak-to-Peak Output Voltage vs Frequency

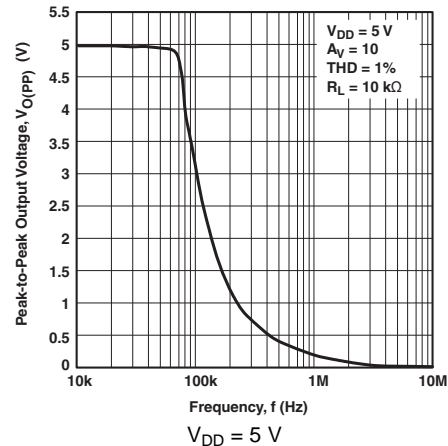

Figure 10. Peak-to-Peak Output Voltage vs Frequency

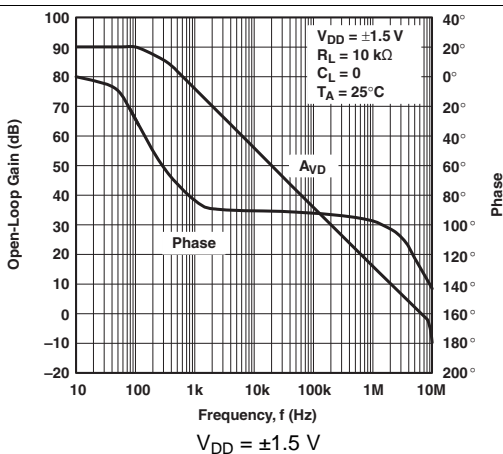

Figure 11. Open-Loop Gain and Phase vs Frequency

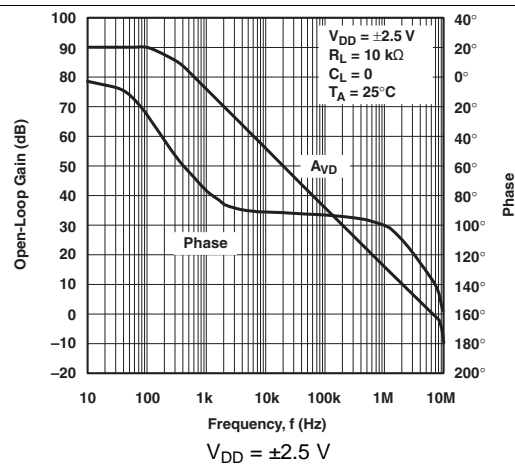

Figure 12. Open-Loop Gain and Phase vs Frequency

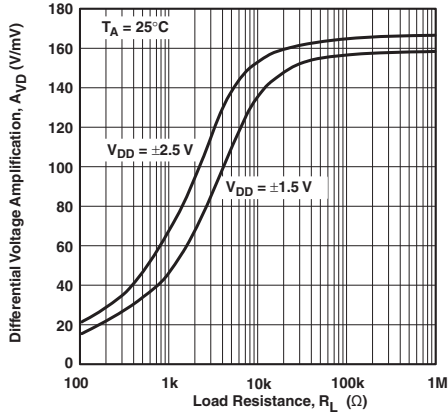

Figure 13. Differential Voltage Amplification vs Load Resistance

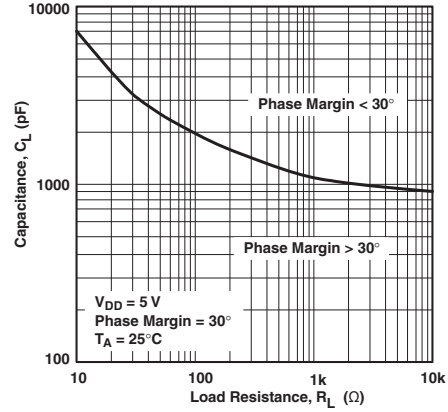

Figure 14. Capacitive Load vs Load Resistance

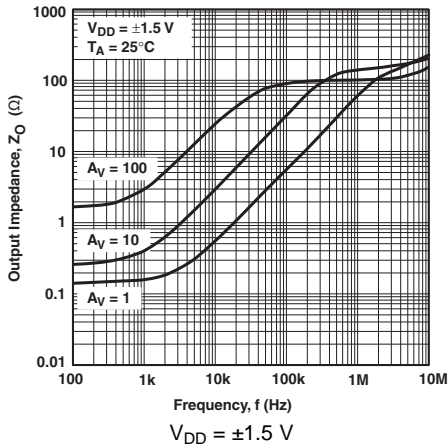

Figure 15. Output Impedance vs Frequency

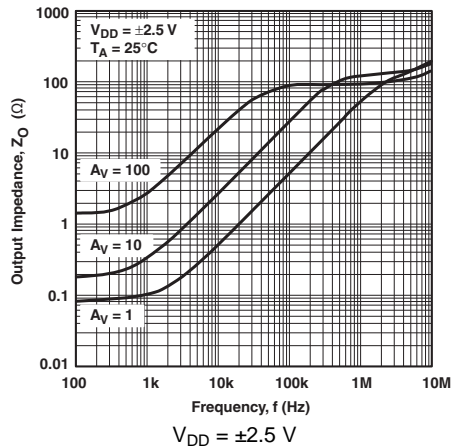

Figure 16. Output Impedance vs Frequency

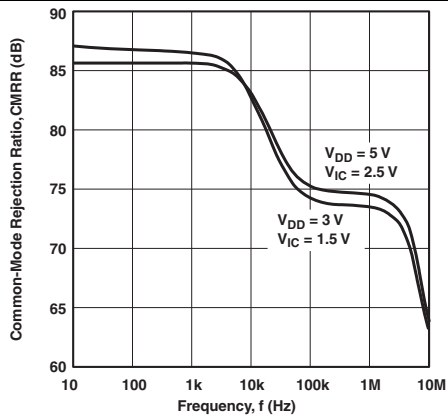

Figure 17. Common-Mode Rejection Ratio vs Frequency

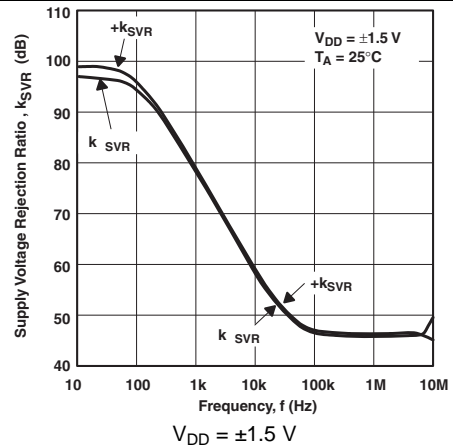

Figure 18. Supply-Voltage Rejection Ratio vs Frequency

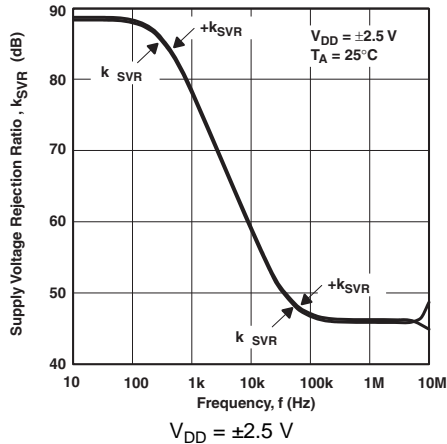

Figure 19. Supply-Voltage Rejection Ratio vs Frequency

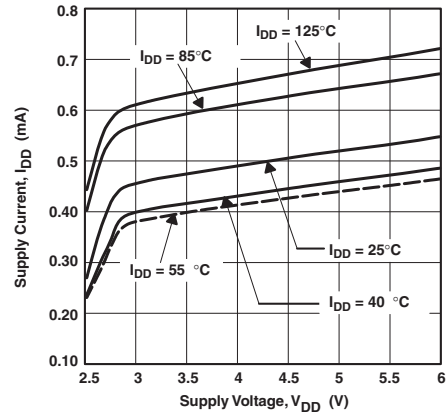

Figure 20. Supply Current vs Supply Voltage

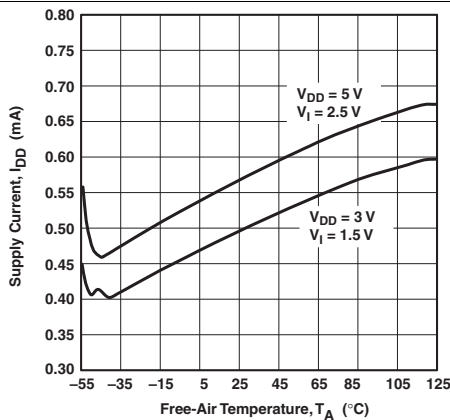

Figure 21. Supply Current vs Free-Air Temperature

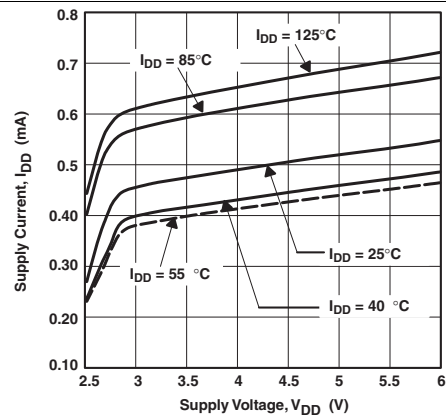

Figure 22. Amplifier With a Shutdown Pulse Turnon Characteristics

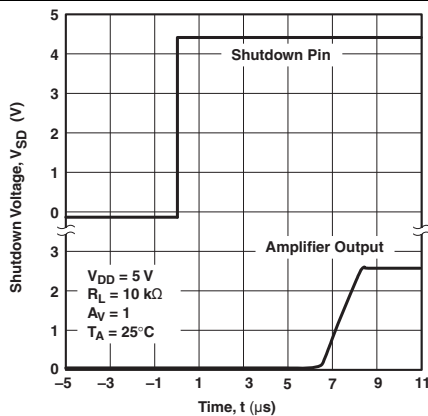

Figure 23. Amplifier With a Shutdown Pulse Turnoff Characteristics

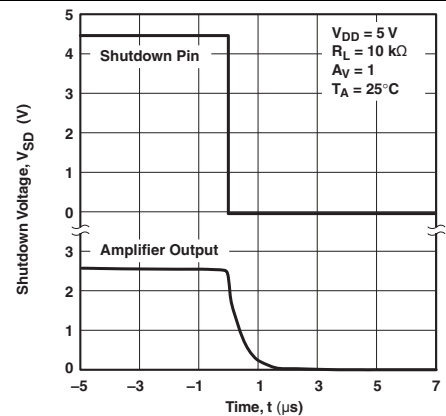

Figure 24. Supply Current With a Shutdown Pulse Turnon Characteristics

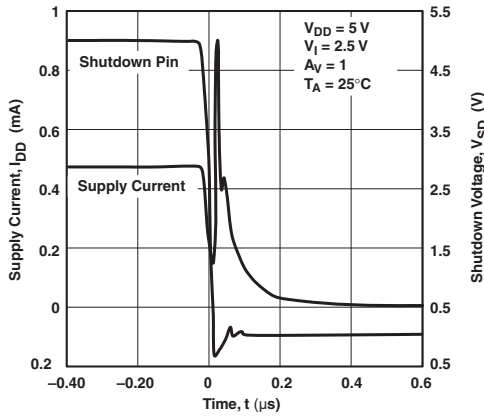

Figure 25. Turnoff Supply Current With a Shutdown Pulse

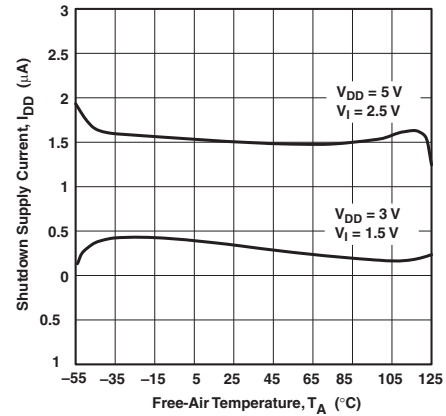

Figure 26. Shutdown Supply Current vs Free-Air Temperature

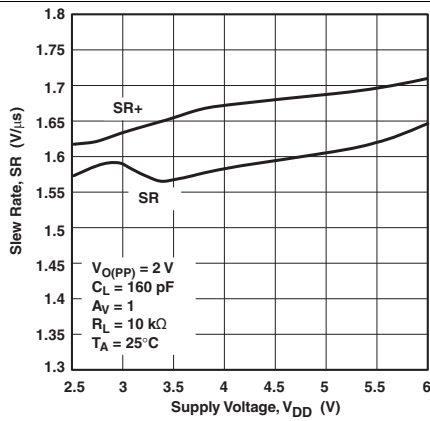

Figure 27. Slew Rate vs Supply Voltage

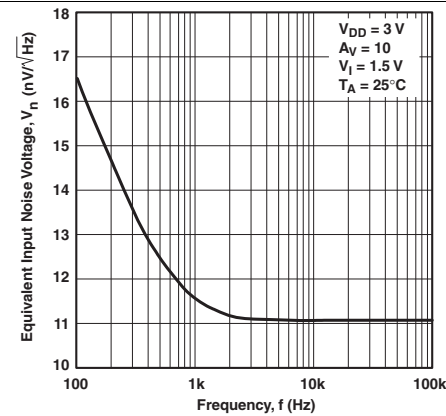

Figure 28. Equivalent Input Noise Voltage vs Frequency

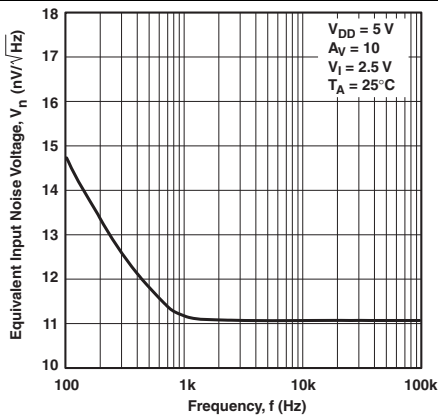

Figure 29. Equivalent Input Noise Voltage vs Frequency

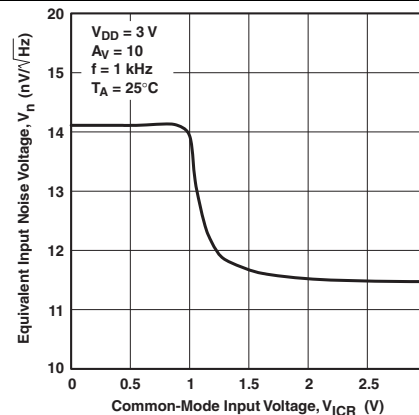

Figure 30. Equivalent Input Noise Voltage vs Common-Mode Input Voltage

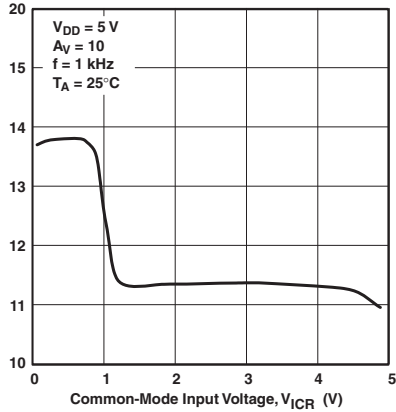

Figure 31. Equivalent Input Noise Voltage vs Common-Mode Input Voltage

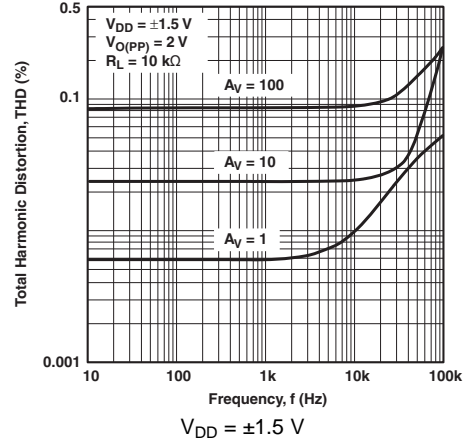

Figure 32. Total Harmonic Distortion vs Frequency

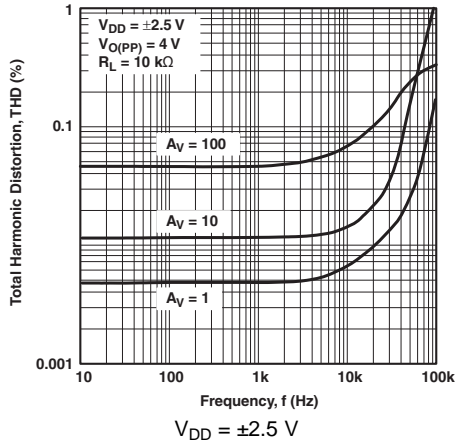

Figure 33. Total Harmonic Distortion vs Frequency

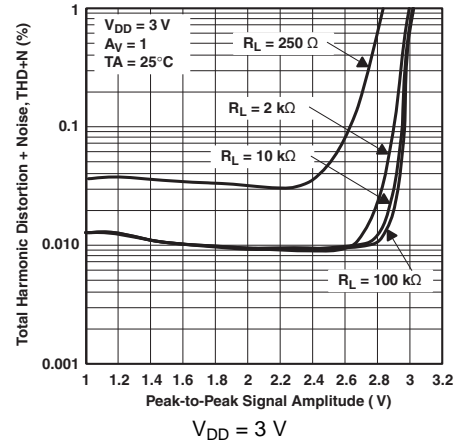

Figure 34. Total Harmonic Distortion Plus Noise vs Peak-to-Peak Signal Amplitude

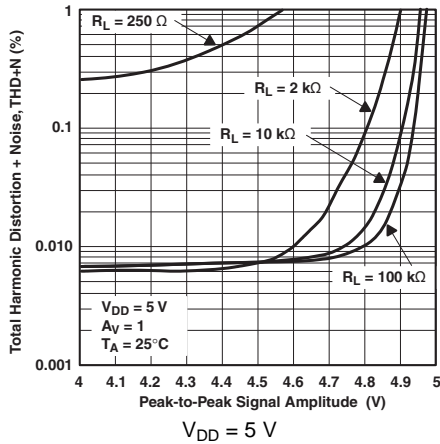

Figure 35. Total Harmonic Distortion Plus Noise vs Peak-to-Peak Signal Amplitude

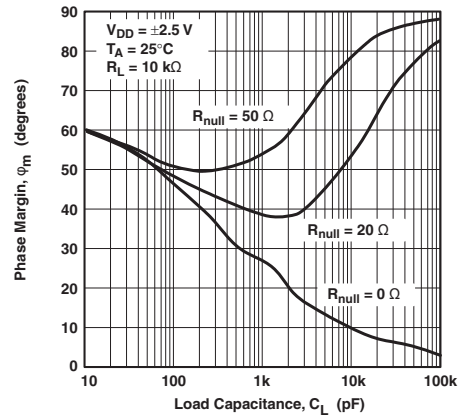

Figure 36. Phase Margin vs Load Capacitance

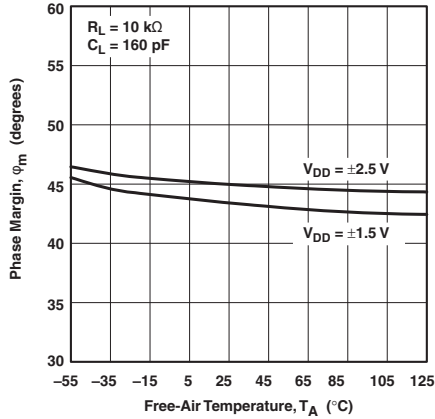

Figure 37. Phase Margin vs Free-Air Temperature

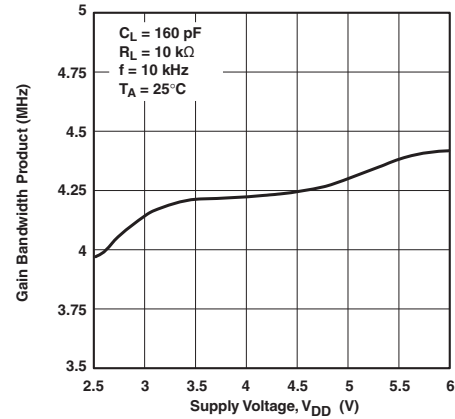

Figure 38. Gain Bandwidth Product vs Supply Voltage

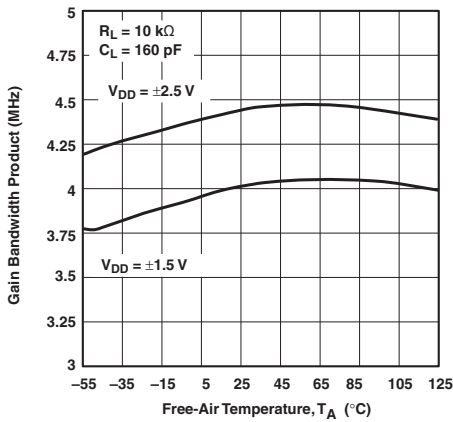

Figure 39. Gain Bandwidth Product vs Free-Air Temperature

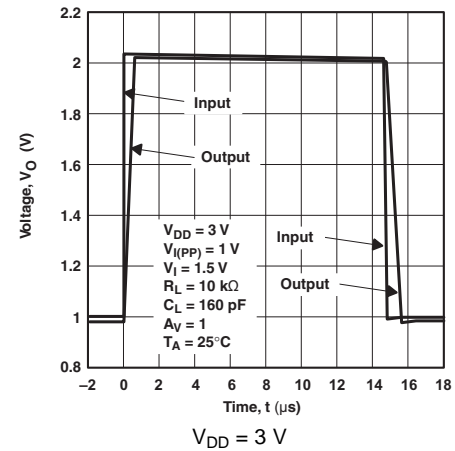

Figure 40. Large Signal Follower

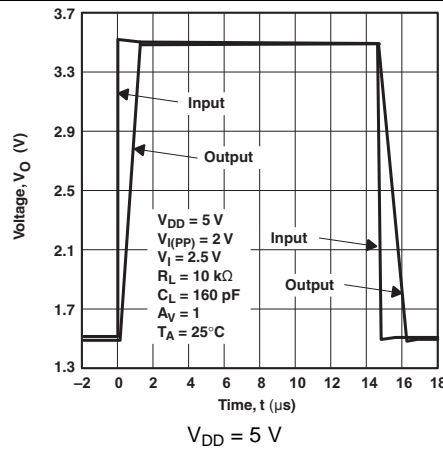

Figure 41. Large Signal Follower

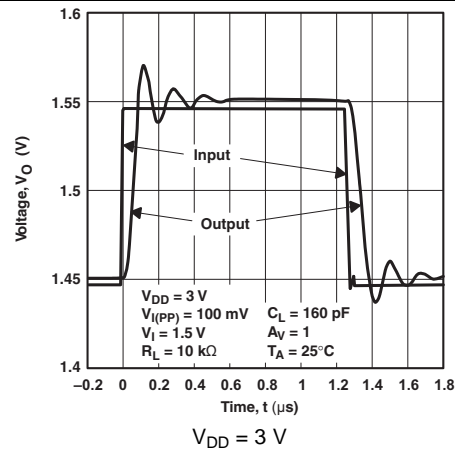

Figure 42. Small Signal Follower

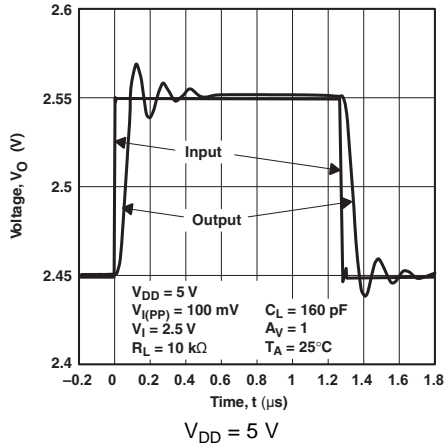

Figure 43. Small Signal Follower

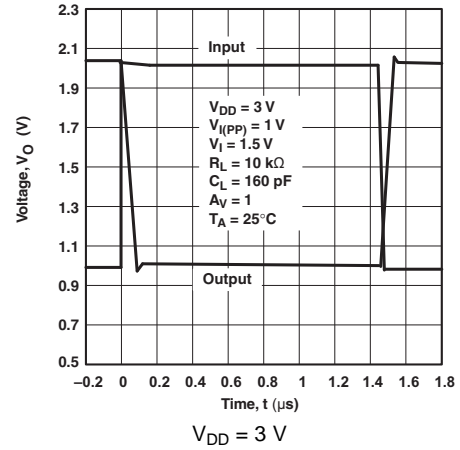

Figure 44. Inverting Large Signal

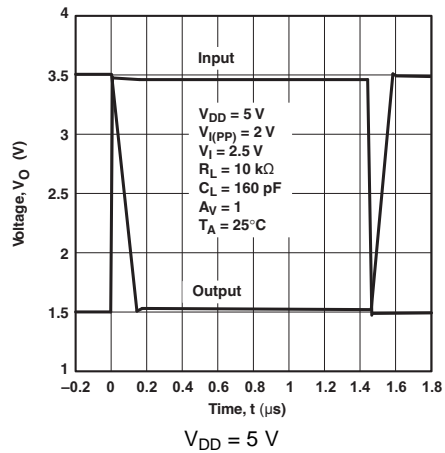

Figure 45. Inverting Large Signal

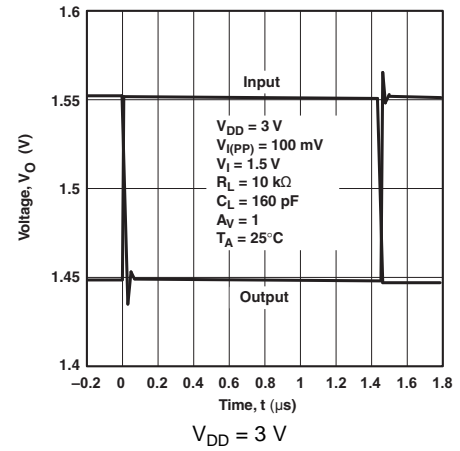

Figure 46. Inverting Small Signal

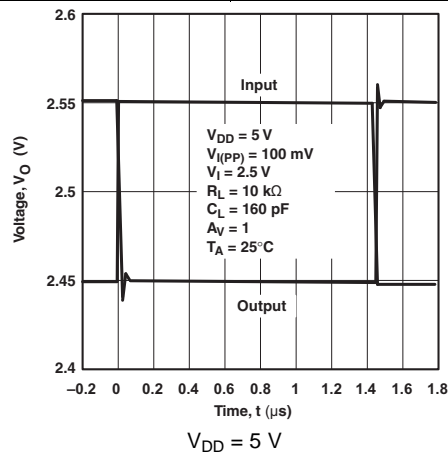

Figure 47. Inverting Small Signal

## 7 Parameter Measurement Information

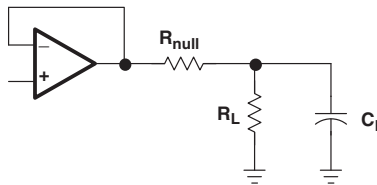

Figure 48. Capacitive Load Drive

## 8 Detailed Description

### 8.1 Overview

The TLV246x-Q1 family of devices are low-power rail-to-rail input and output operational amplifiers. The input common-mode voltage range extends beyond the supply rails for maximum dynamic range in a low-voltage system. The amplifier output has rail-to-rail performance with high drive capability, solving one of the limitations of older rail-to-rail input and output operational amplifiers.

### 8.2 Functional Block Diagram

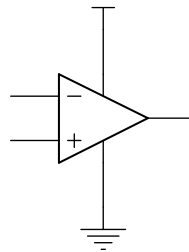

### 8.3 Feature Description

The TLV246x-Q1 family features 6.4-MHz bandwidth and voltage noise of 11 nV/ $\sqrt{\text{Hz}}$  with performance rated from 2.7 V to 6 V across an automotive temperature range ( $-40^{\circ}\text{C}$  to  $+125^{\circ}\text{C}$ ). This family is designed for a wide range of automotive applications.

#### 8.3.1 Driving a Capacitive Load

When the amplifier configuration is in this manner, capacitive loading directly on the output decreases the phase margin of the device leading to high-frequency ringing or oscillations. Therefore, for capacitive loads of greater than 10 pF, TI recommends placing a resistor in series ( $R_{\text{NULL}}$ ) with the output of the amplifier; see Figure 49. A minimum value of 20  $\Omega$  works well for most applications.

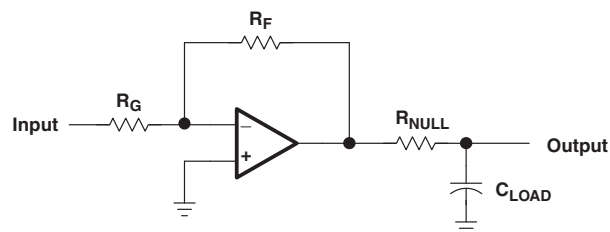

Figure 49. Driving a Capacitive Load

## Feature Description (continued)

### 8.3.2 Offset Voltage

The output offset voltage ( $V_{OO}$ ) is the sum of the input offset voltage ( $V_{IO}$ ) and both input-bias currents ( $I_{IB}$ ) times the corresponding gains. Use the schematic and formula in Figure 50 to calculate the output offset voltage.

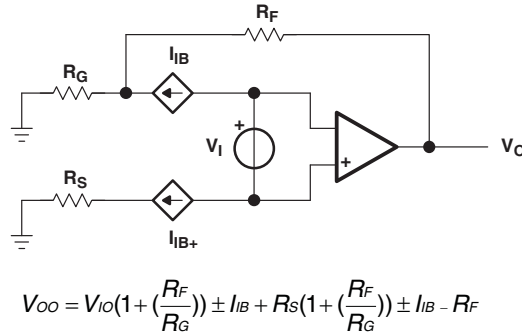

Figure 50. Output Offset Voltage Model

### 8.3.3 General Configurations

When receiving low-level signals, limiting the bandwidth of the incoming signals into the system is often required. To limit bandwidth, place an RC filter at the noninverting terminal of the amplifier (see Figure 51).

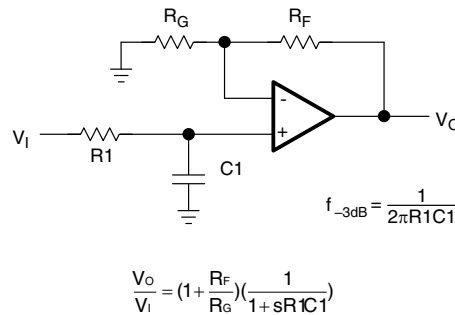

Figure 51. Single-Pole Low-Pass Filter

If even more attenuation is required, a multiple pole filter is required. Use a Sallen-Key filter for this task; see Figure 52. For best results, the amplifier must have a bandwidth that is eight to ten times the filter frequency bandwidth. Failure to do this can result in phase shift of the amplifier.

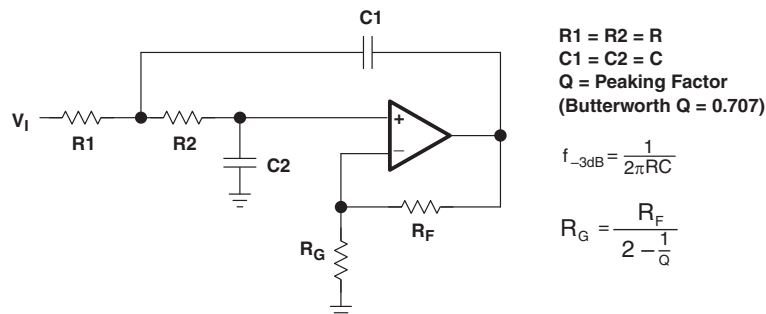

Figure 52. 2-Pole Low-Pass Sallen-Key Filter

## Feature Description (continued)

### 8.3.4 General Power Dissipation Considerations

For a given  $\theta_{JA}$  value, the maximum power dissipation is shown in [Figure 53](#) and is calculated by [Equation 1](#):

$$P_D = \left( \frac{T_{MAX} - T_A}{\theta_{JA}} \right)$$

Where:

- $P_D$  = Maximum power dissipation of TLV246x-Q1 (watts)
- $T_{MAX}$  = Absolute maximum junction temperature (150°C)
- $T_A$  = Ambient free-air temperature (°C)
- $\theta_{JA} = \theta_{JC} + \theta_{CA}$
- $\theta_{JC}$  = Thermal coefficient from junction to case
- $\theta_{CA}$  = Thermal coefficient from case to ambient air (°C/W)

(1)

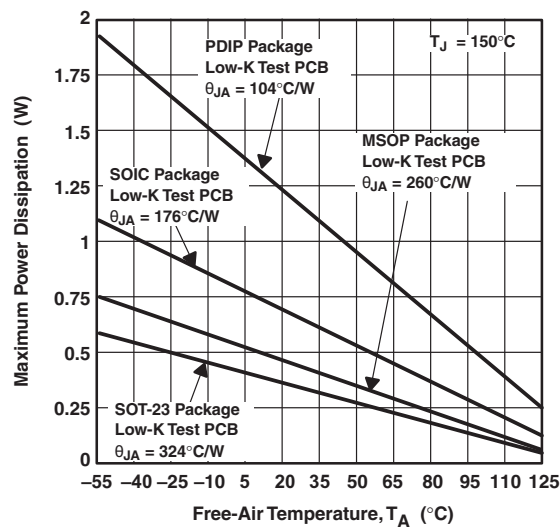

Figure 53. Maximum Power Dissipation vs Free-Air Temperature

## 8.4 Device Functional Modes

The TLV2461-Q1, TLV2462-Q1, and TLV2464A-Q1 devices power on when the supply is connected. These devices can operate with a single supply or dual supplies, depending on the application. The devices are in their full performance once the supply is above the recommended value. The TLV2460-Q1 and TLV2463-Q1 devices feature a shutdown mode, which reduces the quiescent current to 0.3  $\mu\text{A}$  in shutdown mode.

### 8.4.1 Shutdown Function

Two members of the TLV246x-Q1 family (TLV2460-Q1 and TLV2463-Q1) feature a shutdown terminal that conserves battery life in portable applications. When the shutdown terminal is tied low, the supply current is reduced to 0.3  $\mu\text{A}$  per channel, the amplifier is disabled and the outputs are placed in a high-impedance mode. To enable the amplifier, leave the shutdown terminal floating or pull the shutdown terminal high. When the shutdown terminal is left floating, take care to ensure that parasitic leakage current at the shutdown terminal does not inadvertently place the operational amplifier into shutdown. The shutdown terminal threshold is always referenced to  $V_{\text{DD}} / 2$ . As a result, when operating the device with split-supply voltages (for example,  $\pm 2.5\text{ V}$ ), the shutdown terminal must be pulled to  $V_{\text{DD}}^-$  (not GND) to disable the operational amplifier.

The output of the amplifier with a shutdown pulse is shown in [Figure 22](#), [Figure 23](#), [Figure 24](#), and [Figure 25](#). The amplifier is powered with a single 5-V supply and configured as a noninverting configuration with a gain of 5. The amplifier turnon and turnoff times are measured from the 50% point of the shutdown pulse to the 50% point of the output waveform. The times for the single, dual, and quad are listed in the data tables.

## 9 Application and Implementation

### NOTE

Information in the following applications sections is not part of the TI component specification, and TI does not warrant its accuracy or completeness. TI's customers are responsible for determining suitability of components for their purposes. Customers should validate and test their design implementation to confirm system functionality.

### 9.1 Application Information

Most DC-to-DC converters use output-filter ceramic capacitors with very low equivalent series resistance (ESR).

This causes a double pole at the resonance frequency  $\frac{1}{2\pi\sqrt{LC}}$ .

To achieve an adequate bandwidth and phase margin for the DC-to-DC converter, the device requires

compensation around the  $\frac{1}{2\pi\sqrt{LC}}$  resonance frequency. To achieve this, configure the error amplifier as type-3 compensation. The TLV2426x-Q1 series features a wide bandwidth UGBD of 6 MHz with rail-to-rail output for increased dynamic range. These features are designed for DC-to-DC loop compensation with any LC filter.

#### 9.1.1 Macromodel Information

Macromodel information provided was derived using Microsim Parts™ Release 8, the model generation software used with Microsim PSpice™. The Boyle macromodel <sup>(1)</sup> and subcircuit in [Figure 54](#) are generated using the TLV246x-Q1 typical electrical and operating characteristics at T<sub>A</sub> = 25°C. Using this information, output simulations of the following key parameters are generated to a tolerance of 20% (in most cases):

(1) G. R. Boyle, B. M. Cohn, D. O. Pederson, and J. E. Solomon, "Macromodeling of Integrated Circuit Operational Amplifiers," *IEEE Journal of Solid-State Circuits*, SC-9, 353 (1974).

- Maximum positive output voltage swing
- Maximum negative output voltage swing
- Slew rate
- Quiescent power dissipation
- Input bias current
- Open-loop voltage amplification
- Unity gain frequency
- Common-mode rejection ratio
- Phase margin
- DC output resistance
- AC output resistance
- Short-circuit output current limit



## 9.2 Typical Application

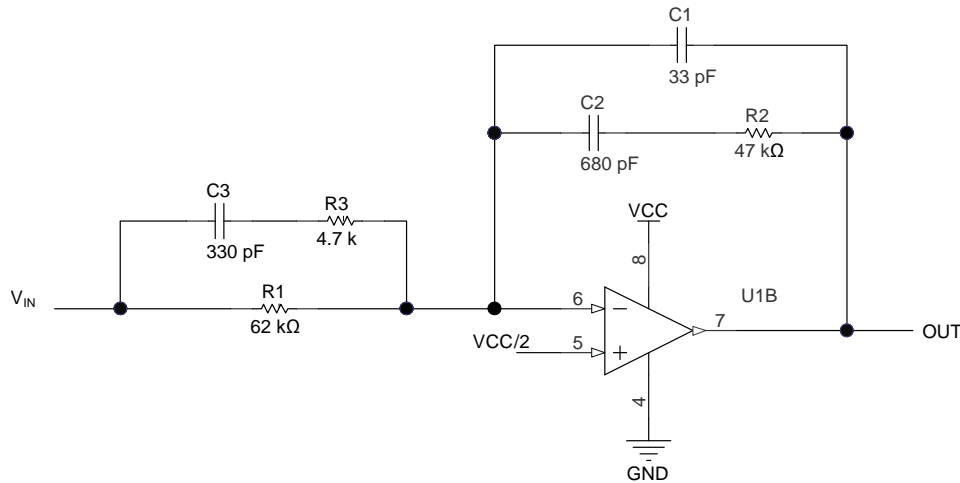

Figure 55. Typical Operational Amplifier Application

### 9.2.1 Design Requirements

See [Table 2](#) for design requirements.

Table 2. Recommended Design Parameters

PARAMETER	VALUE
Supply voltage	5 V
Reference voltage	2.5 V
Input voltage	2.5 V DC and maximum ripple 40 mV peak-to-peak
Capacitors	Better than X5R
Resistors	Better than 2% tolerance

### 9.2.2 Detailed Design Procedure

The following section shows the detailed design procedure. See [Equation 2](#) for the type-3 compensation gain.

$$\text{Type 3 Compensation Gain} = \frac{(1 + R2C2s)(1 + (R1 + R3)C3s)}{R1(C1 + C2)s(1 + R2 \frac{C1C2}{C1 + C2}s)(1 + R3Cs)} \quad (2)$$

Type-3 compensation poles and zeros are shown in the preferred asymptotic graph; see [Figure 56](#). Relocate the compensation poles and zeroes by changing the values of the resistors and capacitors according to the compensation requirement. The operational amplifier cannot achieve the preferred case because of the open-loop gain and phase limitation of the amplifier.

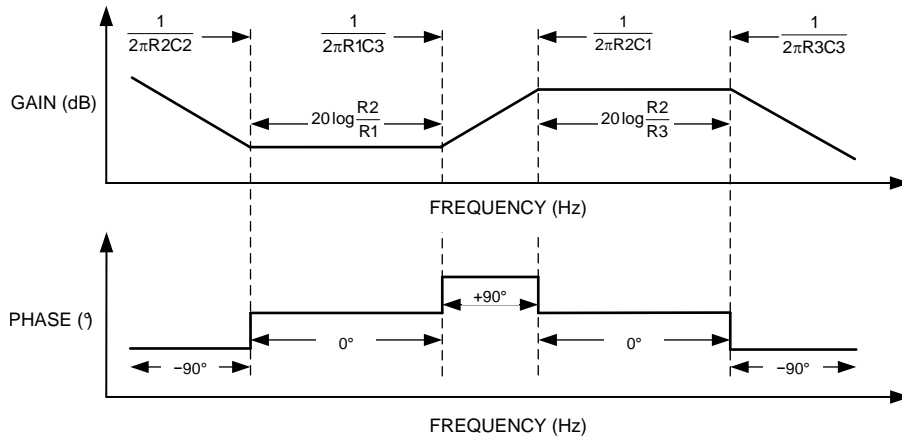

**Figure 56. Preferred Asymptotic Graph**

The poles and zeros are calculated assuming  $C2 \gg C1$  and  $R1 \gg R3$ . This assumption is correct because the  $C1$  and  $R3$  components set the high frequencies.

This TLV226x-Q1 device type-3 compensation circuit design boosts the gain and phase for the DC-to-DC converter around 30-KHz resonance frequencies. This corresponds to 1  $\mu$ H and 22  $\mu$ F for the output filter.

The operational amplifier is configured as type-2 compensation by omitting the  $C3$  capacitor. Type-2 compensates the DC-to-DC converter with an output capacitor with a series resistor ESR; see Equation 3.

$$\text{Type 2 Compensation Gain} = \frac{(1 + R2C2s)}{R1(C1 + C2) s (1 + R2 \frac{C1C2}{C1+C2} s)} \quad (3)$$

### 9.2.3 Application Curve

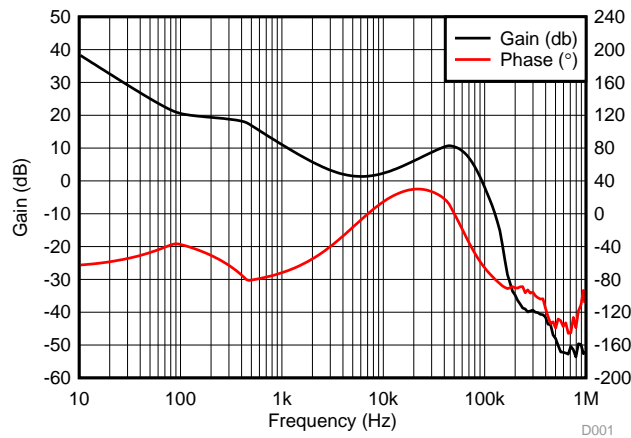

Frequency: 10 Hz to 1 MHz

Gain boost = 12 dB around 30 KHz

Phase boost = 30° around 30 KHz

**Figure 57. Gain and Phase Plot**

## 10 Power Supply Recommendations

The TLV246X-Q1 family of devices operation specification is from 2.7 V to 6 V for a single power supply and  $\pm 1.35$  V to  $\pm 3$  V for dual power supplies.

TI recommends placing a 0.1- $\mu$ F bypass capacitor close to the power supply pins to reduce errors coupling in from noisy or high-impedance power supplies.

## 11 Layout

### 11.1 Layout Guidelines

To achieve the levels of high performance of the TLV246x-Q1, follow proper printed-circuit board design techniques. A general set of guidelines is shown in the following list.

- TI recommends using a ground plane on the board to provide all components with a low inductive ground connection. However, in the areas of the amplifier inputs and output, the ground plane is removed to minimize the stray capacitance.
- Use a 6.8- $\mu$ F tantalum capacitor in parallel with a 0.1- $\mu$ F ceramic capacitor on each supply terminal. It may be possible to share the tantalum among several amplifiers depending on the application, but a 0.1- $\mu$ F ceramic capacitor must always be used on the supply terminal of every amplifier. In addition, the 0.1- $\mu$ F capacitor must be placed as close as possible to the supply terminal. As this distance increases, the inductance in the connecting trace makes the capacitor less effective. The designer must strive for distances of less than 0.1 inches between the device power terminals and the ceramic capacitors.
- TI does not recommend using sockets. The additional lead inductance in the socket pins often leads to stability problems. For best implementation, solder surface-mount packages directly to the printed circuit board.
- Optimum high performance is achieved when stray series inductance is minimized. The circuit layout must be made as compact as possible, which minimizes the length of all trace runs. Take care to pay attention to the inverting input of the amplifier; keep the length as short as possible. This minimizes stray capacitance at the input of the amplifier.
- TI recommends using surface mount passive components for high performance amplifier circuits. Stray series inductance is reduced because of the low lead inductance of surface mount components. The small size of surface-mount components leads to a compact layout, which minimizes stray inductance and capacitance. TI recommends that lead lengths be kept as short as possible if leaded components are used.

### 11.2 Layout Example

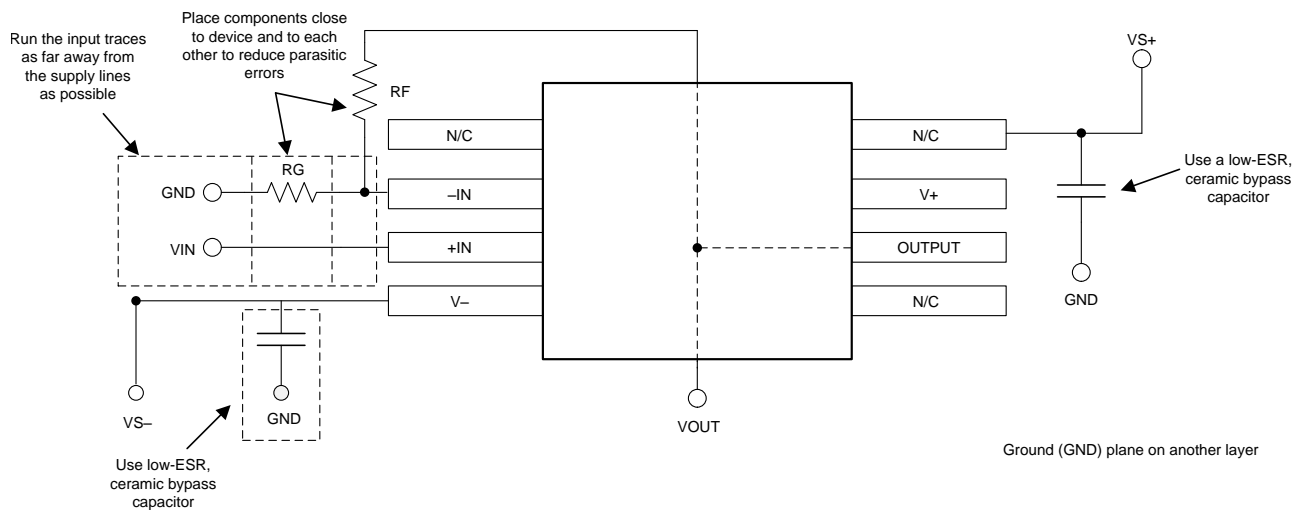

Copyright © 2017, Texas Instruments Incorporated

Figure 58. Operational Amplifier Board Layout for Noninverting Configuration

## 12 Device and Documentation Support

### 12.1 Documentation Support

#### 12.1.1 Related Documentation

For related documentation see the following:

- Texas Instruments, [An audio circuit collection, Part 1](#)
- G. R. Boyle, B. M. Cohn, D. O. Pederson, and J. E. Solomon, "Macromodeling of Integrated Circuit Operational Amplifiers," *IEEE Journal of Solid-State Circuits*, SC-9, 353 (1974).

### 12.2 Related Links

The table below lists quick access links. Categories include technical documents, support and community resources, tools and software, and quick access to sample or buy.

Table 3. Related Links

PARTS	PRODUCT FOLDER	SAMPLE & BUY	TECHNICAL DOCUMENTS	TOOLS & SOFTWARE	SUPPORT & COMMUNITY
TLV2460-Q1	<a href="#">Click here</a>	<a href="#">Click here</a>	<a href="#">Click here</a>	<a href="#">Click here</a>	<a href="#">Click here</a>
TLV2461-Q1	<a href="#">Click here</a>	<a href="#">Click here</a>	<a href="#">Click here</a>	<a href="#">Click here</a>	<a href="#">Click here</a>
TLV2462-Q1	<a href="#">Click here</a>	<a href="#">Click here</a>	<a href="#">Click here</a>	<a href="#">Click here</a>	<a href="#">Click here</a>
TLV2463-Q1	<a href="#">Click here</a>	<a href="#">Click here</a>	<a href="#">Click here</a>	<a href="#">Click here</a>	<a href="#">Click here</a>
TLV2460A-Q1	<a href="#">Click here</a>	<a href="#">Click here</a>	<a href="#">Click here</a>	<a href="#">Click here</a>	<a href="#">Click here</a>
TLV2461A-Q1	<a href="#">Click here</a>	<a href="#">Click here</a>	<a href="#">Click here</a>	<a href="#">Click here</a>	<a href="#">Click here</a>
TLV2462A-Q1	<a href="#">Click here</a>	<a href="#">Click here</a>	<a href="#">Click here</a>	<a href="#">Click here</a>	<a href="#">Click here</a>
TLV2463A-Q1	<a href="#">Click here</a>	<a href="#">Click here</a>	<a href="#">Click here</a>	<a href="#">Click here</a>	<a href="#">Click here</a>
TLV2464A-Q1	<a href="#">Click here</a>	<a href="#">Click here</a>	<a href="#">Click here</a>	<a href="#">Click here</a>	<a href="#">Click here</a>

### 12.3 Community Resources

The following links connect to TI community resources. Linked contents are provided "AS IS" by the respective contributors. They do not constitute TI specifications and do not necessarily reflect TI's views; see TI's [Terms of Use](#).

**TI E2E™ Online Community** *TI's Engineer-to-Engineer (E2E) Community*. Created to foster collaboration among engineers. At [e2e.ti.com](http://e2e.ti.com), you can ask questions, share knowledge, explore ideas and help solve problems with fellow engineers.

**Design Support** *TI's Design Support* Quickly find helpful E2E forums along with design support tools and contact information for technical support.

### 12.4 Trademarks

E2E is a trademark of Texas Instruments.  
 All other trademarks are the property of their respective owners.

### 12.5 Electrostatic Discharge Caution



These devices have limited built-in ESD protection. The leads should be shorted together or the device placed in conductive foam during storage or handling to prevent electrostatic damage to the MOS gates.

### 12.6 Glossary

**SLYZ022** — *TI Glossary*.

This glossary lists and explains terms, acronyms, and definitions.

### 13 Mechanical, Packaging, and Orderable Information

The following pages include mechanical, packaging, and orderable information. This information is the most current data available for the designated devices. This data is subject to change without notice and revision of this document. For browser-based versions of this data sheet, refer to the left-hand navigation.

**PACKAGING INFORMATION**

Orderable Device	Status (1)	Package Type	Package Drawing	Pins	Package Qty	Eco Plan (2)	Lead finish/ Ball material (6)	MSL Peak Temp (3)	Op Temp (°C)	Device Marking (4/5)	Samples
TLV2460AQPWRG4Q1	ACTIVE	TSSOP	PW	8	2000	RoHS & Green	NIPDAU	Level-1-260C-UNLIM	-40 to 125	2460AQ	<a href="#">Samples</a>
TLV2461AQPWRG4Q1	ACTIVE	TSSOP	PW	8	2000	RoHS & Green	NIPDAU	Level-1-260C-UNLIM	-40 to 125	2461AQ	<a href="#">Samples</a>
TLV2462AQDRQ1	ACTIVE	SOIC	D	8	2500	RoHS & Green	NIPDAU	Level-1-260C-UNLIM	-40 to 125	2462AQ	<a href="#">Samples</a>
TLV2462AQPWRG4Q1	ACTIVE	TSSOP	PW	8	2000	RoHS & Green	NIPDAU	Level-1-260C-UNLIM	-40 to 125	2462AQ	<a href="#">Samples</a>
TLV2462AQPWRQ1	ACTIVE	TSSOP	PW	8	2000	RoHS & Green	NIPDAU	Level-1-260C-UNLIM	-40 to 125	2462AQ	<a href="#">Samples</a>
TLV2462QDGKRQ1	ACTIVE	VSSOP	DGK	8	2500	RoHS & Green	NIPDAU   NIPDAUAG	Level-2-260C-1 YEAR	-40 to 125	QVM	<a href="#">Samples</a>
TLV2462QDRG4Q1	ACTIVE	SOIC	D	8	2500	RoHS & Green	NIPDAU	Level-1-260C-UNLIM	-40 to 125	2462Q1	<a href="#">Samples</a>
TLV2462QDRQ1	ACTIVE	SOIC	D	8	2500	RoHS & Green	NIPDAU	Level-1-260C-UNLIM	-40 to 125	2462Q1	<a href="#">Samples</a>
TLV2462QPWRG4Q1	ACTIVE	TSSOP	PW	8	2000	RoHS & Green	NIPDAU	Level-1-260C-UNLIM	-40 to 125	2462Q1	<a href="#">Samples</a>
TLV2463AQPWRG4Q1	ACTIVE	TSSOP	PW	14	2000	RoHS & Green	NIPDAU	Level-1-260C-UNLIM	-40 to 125	2463AQ1	<a href="#">Samples</a>
TLV2464AQPWRG4Q1	ACTIVE	TSSOP	PW	14	2000	RoHS & Green	NIPDAU	Level-1-260C-UNLIM	-40 to 125	V2464AQ	<a href="#">Samples</a>
TLV2464AQPWRQ1	ACTIVE	TSSOP	PW	14	2000	RoHS & Green	NIPDAU	Level-1-260C-UNLIM	-40 to 125	V2464AQ	<a href="#">Samples</a>

(1) The marketing status values are defined as follows:

**ACTIVE:** Product device recommended for new designs.

**LIFEBUY:** TI has announced that the device will be discontinued, and a lifetime-buy period is in effect.

**NRND:** Not recommended for new designs. Device is in production to support existing customers, but TI does not recommend using this part in a new design.

**PREVIEW:** Device has been announced but is not in production. Samples may or may not be available.

**OBSELETE:** TI has discontinued the production of the device.

(2) **RoHS:** TI defines "RoHS" to mean semiconductor products that are compliant with the current EU RoHS requirements for all 10 RoHS substances, including the requirement that RoHS substance do not exceed 0.1% by weight in homogeneous materials. Where designed to be soldered at high temperatures, "RoHS" products are suitable for use in specified lead-free processes. TI may reference these types of products as "Pb-Free".

**RoHS Exempt:** TI defines "RoHS Exempt" to mean products that contain lead but are compliant with EU RoHS pursuant to a specific EU RoHS exemption.

**Green:** TI defines "Green" to mean the content of Chlorine (Cl) and Bromine (Br) based flame retardants meet JS709B low halogen requirements of <=1000ppm threshold. Antimony trioxide based flame retardants must also meet the <=1000ppm threshold requirement.

- (3) MSL, Peak Temp. - The Moisture Sensitivity Level rating according to the JEDEC industry standard classifications, and peak solder temperature.
- (4) There may be additional marking, which relates to the logo, the lot trace code information, or the environmental category on the device.
- (5) Multiple Device Markings will be inside parentheses. Only one Device Marking contained in parentheses and separated by a "~" will appear on a device. If a line is indented then it is a continuation of the previous line and the two combined represent the entire Device Marking for that device.
- (6) Lead finish/Ball material - Orderable Devices may have multiple material finish options. Finish options are separated by a vertical ruled line. Lead finish/Ball material values may wrap to two lines if the finish value exceeds the maximum column width.

**Important Information and Disclaimer:**The information provided on this page represents TI's knowledge and belief as of the date that it is provided. TI bases its knowledge and belief on information provided by third parties, and makes no representation or warranty as to the accuracy of such information. Efforts are underway to better integrate information from third parties. TI has taken and continues to take reasonable steps to provide representative and accurate information but may not have conducted destructive testing or chemical analysis on incoming materials and chemicals. TI and TI suppliers consider certain information to be proprietary, and thus CAS numbers and other limited information may not be available for release.

In no event shall TI's liability arising out of such information exceed the total purchase price of the TI part(s) at issue in this document sold by TI to Customer on an annual basis.

**OTHER QUALIFIED VERSIONS OF TLV2460A-Q1, TLV2461A-Q1, TLV2462-Q1, TLV2462A-Q1, TLV2463A-Q1, TLV2464A-Q1 :**

- Catalog : [TLV2460A](#), [TLV2461A](#), [TLV2462](#), [TLV2462A](#), [TLV2463A](#), [TLV2464A](#)
- Enhanced Product : [TLV2462A-EP](#), [TLV2464A-EP](#)
- Military : [TLV2462M](#), [TLV2462AM](#), [TLV2463AM](#)

NOTE: Qualified Version Definitions:

- Catalog - TI's standard catalog product
- Enhanced Product - Supports Defense, Aerospace and Medical Applications
- Military - QML certified for Military and Defense Applications

**TAPE AND REEL INFORMATION**

**QUADRANT ASSIGNMENTS FOR PIN 1 ORIENTATION IN TAPE**

\*All dimensions are nominal

Device	Package Type	Package Drawing	Pins	SPQ	Reel Diameter (mm)	Reel Width W1 (mm)	A0 (mm)	B0 (mm)	K0 (mm)	P1 (mm)	W (mm)	Pin1 Quadrant
TLV2460AQPWRG4Q1	TSSOP	PW	8	2000	330.0	12.4	7.0	3.6	1.6	8.0	12.0	Q1
TLV2461AQPWRG4Q1	TSSOP	PW	8	2000	330.0	12.4	7.0	3.6	1.6	8.0	12.0	Q1
TLV2462AQPWRG4Q1	TSSOP	PW	8	2000	330.0	12.4	7.0	3.6	1.6	8.0	12.0	Q1
TLV2462AQPWRQ1	TSSOP	PW	8	2000	330.0	12.4	7.0	3.6	1.6	8.0	12.0	Q1
TLV2462QDGKRQ1	VSSOP	DGK	8	2500	330.0	12.4	5.3	3.4	1.4	8.0	12.0	Q1
TLV2462QDGKRQ1	VSSOP	DGK	8	2500	330.0	12.4	5.3	3.4	1.4	8.0	12.0	Q1
TLV2462QPWRG4Q1	TSSOP	PW	8	2000	330.0	12.4	7.0	3.6	1.6	8.0	12.0	Q1
TLV2463AQPWRG4Q1	TSSOP	PW	14	2000	330.0	12.4	6.9	5.6	1.6	8.0	12.0	Q1
TLV2464AQPWRG4Q1	TSSOP	PW	14	2000	330.0	12.4	6.9	5.6	1.6	8.0	12.0	Q1
TLV2464AQPWRQ1	TSSOP	PW	14	2000	330.0	12.4	6.9	5.6	1.6	8.0	12.0	Q1

**TAPE AND REEL BOX DIMENSIONS**

\*All dimensions are nominal



Device	Package Type	Package Drawing	Pins	SPQ	Length (mm)	Width (mm)	Height (mm)
TLV2460AQPWRG4Q1	TSSOP	PW	8	2000	367.0	367.0	35.0
TLV2461AQPWRG4Q1	TSSOP	PW	8	2000	367.0	367.0	35.0
TLV2462AQPWRG4Q1	TSSOP	PW	8	2000	367.0	367.0	35.0
TLV2462AQPWRQ1	TSSOP	PW	8	2000	356.0	356.0	35.0
TLV2462QDGKRQ1	VSSOP	DGK	8	2500	346.0	346.0	29.0
TLV2462QDGKRQ1	VSSOP	DGK	8	2500	366.0	364.0	50.0
TLV2462QPWRG4Q1	TSSOP	PW	8	2000	367.0	367.0	35.0
TLV2463AQPWRG4Q1	TSSOP	PW	14	2000	367.0	367.0	35.0
TLV2464AQPWRG4Q1	TSSOP	PW	14	2000	367.0	367.0	35.0
TLV2464AQPWRQ1	TSSOP	PW	14	2000	356.0	356.0	35.0

PW (R-PDSO-G14)

PLASTIC SMALL OUTLINE



4040064-3/G 02/11

- NOTES:
- A. All linear dimensions are in millimeters. Dimensioning and tolerancing per ASME Y14.5M-1994.
  - B. This drawing is subject to change without notice.
  -  C. Body length does not include mold flash, protrusions, or gate burrs. Mold flash, protrusions, or gate burrs shall not exceed 0,15 each side.
  -  D. Body width does not include interlead flash. Interlead flash shall not exceed 0,25 each side.
  - E. Falls within JEDEC MO-153

PW (R-PDSO-G14)

PLASTIC SMALL OUTLINE

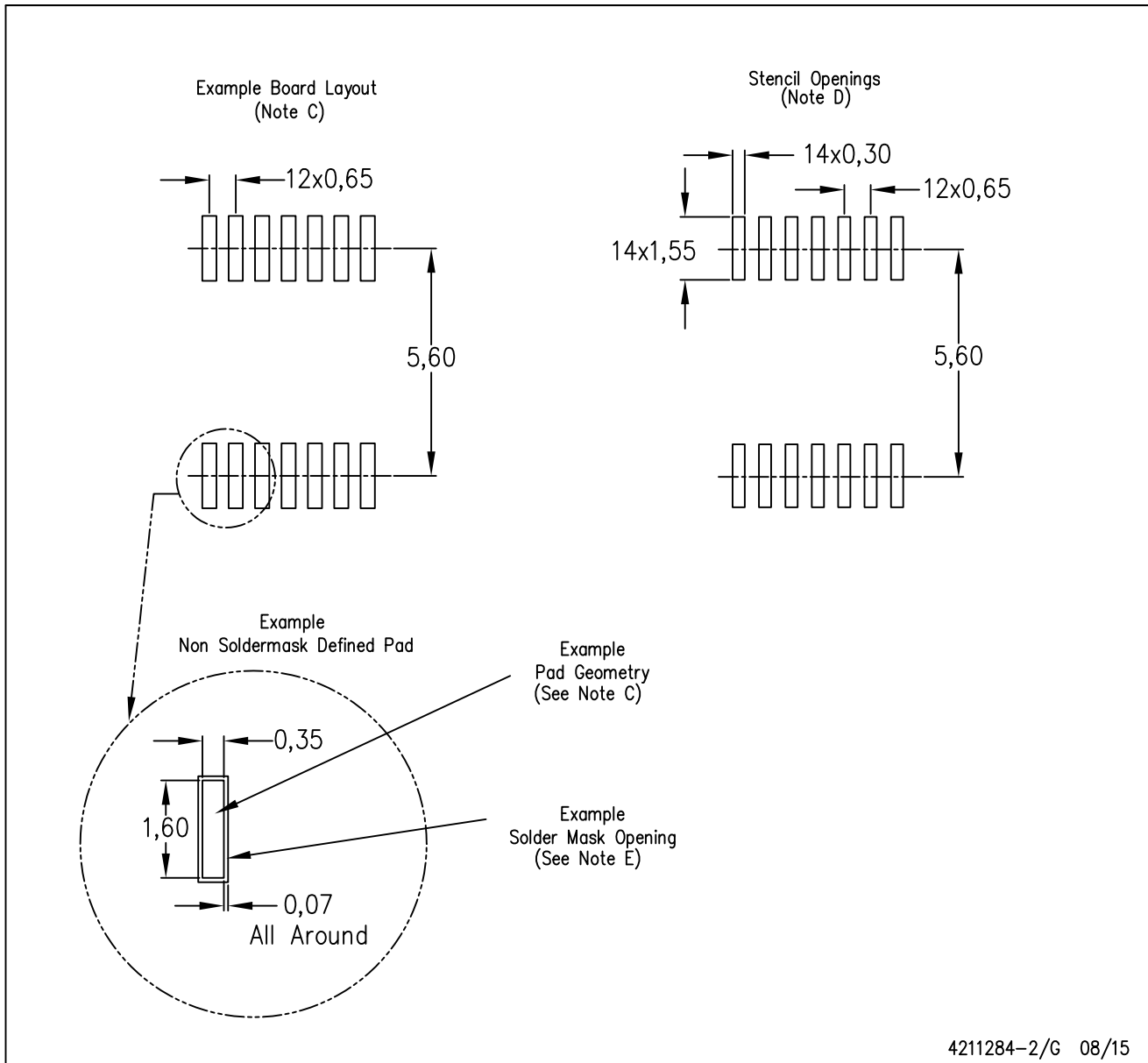

4211284-2/G 08/15

- NOTES:
- All linear dimensions are in millimeters.
  - This drawing is subject to change without notice.
  - Publication IPC-7351 is recommended for alternate designs.
  - Laser cutting apertures with trapezoidal walls and also rounding corners will offer better paste release. Customers should contact their board assembly site for stencil design recommendations. Refer to IPC-7525 for other stencil recommendations.
  - Customers should contact their board fabrication site for solder mask tolerances between and around signal pads.



D0008A

# PACKAGE OUTLINE

SOIC - 1.75 mm max height

SMALL OUTLINE INTEGRATED CIRCUIT



4214825/C 02/2019

### NOTES:

- Linear dimensions are in inches [millimeters]. Dimensions in parenthesis are for reference only. Controlling dimensions are in inches. Dimensioning and tolerancing per ASME Y14.5M.
- This drawing is subject to change without notice.
- This dimension does not include mold flash, protrusions, or gate burrs. Mold flash, protrusions, or gate burrs shall not exceed  $.006$  [0.15] per side.
- This dimension does not include interlead flash.
- Reference JEDEC registration MS-012, variation AA.

# EXAMPLE BOARD LAYOUT

D0008A

SOIC - 1.75 mm max height

SMALL OUTLINE INTEGRATED CIRCUIT



LAND PATTERN EXAMPLE  
 EXPOSED METAL SHOWN  
 SCALE:8X



SOLDER MASK DETAILS

4214825/C 02/2019

NOTES: (continued)

- 6. Publication IPC-7351 may have alternate designs.
- 7. Solder mask tolerances between and around signal pads can vary based on board fabrication site.

# EXAMPLE STENCIL DESIGN

D0008A

SOIC - 1.75 mm max height

SMALL OUTLINE INTEGRATED CIRCUIT



SOLDER PASTE EXAMPLE  
BASED ON .005 INCH [0.125 MM] THICK STENCIL  
SCALE:8X

4214825/C 02/2019

NOTES: (continued)

8. Laser cutting apertures with trapezoidal walls and rounded corners may offer better paste release. IPC-7525 may have alternate design recommendations.
9. Board assembly site may have different recommendations for stencil design.

PW0008A



**PACKAGE OUTLINE**  
**TSSOP - 1.2 mm max height**

SMALL OUTLINE PACKAGE



4221848/A 02/2015

NOTES:

1. All linear dimensions are in millimeters. Any dimensions in parenthesis are for reference only. Dimensioning and tolerancing per ASME Y14.5M.
2. This drawing is subject to change without notice.
3. This dimension does not include mold flash, protrusions, or gate burrs. Mold flash, protrusions, or gate burrs shall not exceed 0.15 mm per side.
4. This dimension does not include interlead flash. Interlead flash shall not exceed 0.25 mm per side.
5. Reference JEDEC registration MO-153, variation AA.

# EXAMPLE BOARD LAYOUT

PW0008A

TSSOP - 1.2 mm max height

SMALL OUTLINE PACKAGE



LAND PATTERN EXAMPLE  
SCALE:10X



SOLDER MASK DETAILS  
NOT TO SCALE

4221848/A 02/2015

NOTES: (continued)

- 6. Publication IPC-7351 may have alternate designs.
- 7. Solder mask tolerances between and around signal pads can vary based on board fabrication site.

# EXAMPLE STENCIL DESIGN

PW0008A

TSSOP - 1.2 mm max height

SMALL OUTLINE PACKAGE



SOLDER PASTE EXAMPLE  
BASED ON 0.125 mm THICK STENCIL  
SCALE:10X

4221848/A 02/2015

NOTES: (continued)

8. Laser cutting apertures with trapezoidal walls and rounded corners may offer better paste release. IPC-7525 may have alternate design recommendations.
9. Board assembly site may have different recommendations for stencil design.

# DGK0008A



# PACKAGE OUTLINE

VSSOP - 1.1 mm max height

SMALL OUTLINE PACKAGE



**NOTES:**

PowerPAD is a trademark of Texas Instruments.

1. All linear dimensions are in millimeters. Any dimensions in parenthesis are for reference only. Dimensioning and tolerancing per ASME Y14.5M.
2. This drawing is subject to change without notice.
3. This dimension does not include mold flash, protrusions, or gate burrs. Mold flash, protrusions, or gate burrs shall not exceed 0.15 mm per side.
4. This dimension does not include interlead flash. Interlead flash shall not exceed 0.25 mm per side.
5. Reference JEDEC registration MO-187.

# EXAMPLE BOARD LAYOUT

DGK0008A

™ VSSOP - 1.1 mm max height

SMALL OUTLINE PACKAGE



LAND PATTERN EXAMPLE  
EXPOSED METAL SHOWN  
SCALE: 15X

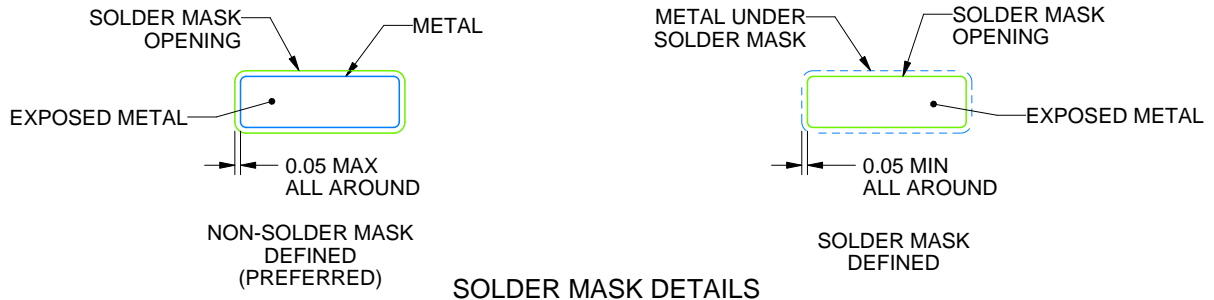

4214862/A 04/2023

NOTES: (continued)

6. Publication IPC-7351 may have alternate designs.
7. Solder mask tolerances between and around signal pads can vary based on board fabrication site.
8. Vias are optional depending on application, refer to device data sheet. If any vias are implemented, refer to their locations shown on this view. It is recommended that vias under paste be filled, plugged or tented.
9. Size of metal pad may vary due to creepage requirement.

# EXAMPLE STENCIL DESIGN

DGK0008A

™ VSSOP - 1.1 mm max height

SMALL OUTLINE PACKAGE



SOLDER PASTE EXAMPLE  
SCALE: 15X

4214862/A 04/2023

NOTES: (continued)

11. Laser cutting apertures with trapezoidal walls and rounded corners may offer better paste release. IPC-7525 may have alternate design recommendations.
12. Board assembly site may have different recommendations for stencil design.

## IMPORTANT NOTICE AND DISCLAIMER

TI PROVIDES TECHNICAL AND RELIABILITY DATA (INCLUDING DATA SHEETS), DESIGN RESOURCES (INCLUDING REFERENCE DESIGNS), APPLICATION OR OTHER DESIGN ADVICE, WEB TOOLS, SAFETY INFORMATION, AND OTHER RESOURCES "AS IS" AND WITH ALL FAULTS, AND DISCLAIMS ALL WARRANTIES, EXPRESS AND IMPLIED, INCLUDING WITHOUT LIMITATION ANY IMPLIED WARRANTIES OF MERCHANTABILITY, FITNESS FOR A PARTICULAR PURPOSE OR NON-INFRINGEMENT OF THIRD PARTY INTELLECTUAL PROPERTY RIGHTS.

These resources are intended for skilled developers designing with TI products. You are solely responsible for (1) selecting the appropriate TI products for your application, (2) designing, validating and testing your application, and (3) ensuring your application meets applicable standards, and any other safety, security, regulatory or other requirements.

These resources are subject to change without notice. TI grants you permission to use these resources only for development of an application that uses the TI products described in the resource. Other reproduction and display of these resources is prohibited. No license is granted to any other TI intellectual property right or to any third party intellectual property right. TI disclaims responsibility for, and you will fully indemnify TI and its representatives against, any claims, damages, costs, losses, and liabilities arising out of your use of these resources.

TI's products are provided subject to [TI's Terms of Sale](#) or other applicable terms available either on [ti.com](https://www.ti.com) or provided in conjunction with such TI products. TI's provision of these resources does not expand or otherwise alter TI's applicable warranties or warranty disclaimers for TI products.

TI objects to and rejects any additional or different terms you may have proposed.

Mailing Address: Texas Instruments, Post Office Box 655303, Dallas, Texas 75265  
Copyright © 2024, Texas Instruments Incorporated

## Looking for pricing, stock, or lifecycle information?

Click below to explore more details on WIN SOURCE:

 [View TLV2462QDRG4Q1 on WIN SOURCE](#)

 [Texas Instruments](#) Information

## Optimize Your Supply Chain with WIN SOURCE Solutions

-  Global Sourcing Solution
-  Obsolete Management
-  Cost Control Management
-  Shortage Management
-  Alternative Solution
-  Excess Inventory Management