



**THE DATASHEET OF
SF1186G**



- **Designed for Front End GPS Applications**
- **Steep Rejection**
- **2.5 x 2.0 x 1.0 mm Surface-Mount Case**
- **No Matching Circuit Required**
- **Complies with Directive 2002/95/EC (RoHS)**
- **Tape and Reel Standard per ANSI/EIA-481**
- **Moisture Sensitivity Level: 1**
- **AEC-Q200 Qualified**

SF1186G

**1575.42 MHz
SAW Filter**

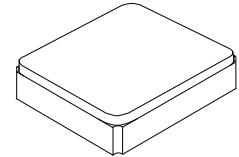

SM2520-4

Absolute Maximum Ratings

Rating	Value	Units
Maximum Input Power, DC to 3 GHz	+10	dBm
Maximum Input Power, 0.8 to 1 GHz and 1.7 to 1.9 GHz	+20	dBm
Maximum DC Voltage On any Non-ground Terminal	5	VDC
Storage Temperature Range in Tape and Reel	-40 to +85	°C
Maximum Soldering Profile (5 cycles maximum)	265 °C for 10 s	

Electrical Characteristics

Characteristic	Sym	Notes	Min	Typ	Max	Units
Nominal Operating Frequency	f_C		1575.42			MHz
Passband Insertion Loss, $f_C \pm 1.0$ MHz	IL			1.5	2.2	dB
Amplitude Ripple, $f_C \pm 1.0$ MHz				0.1	1.0	dB _{P-P}
Attenuation Referenced to 0 dB:						dB
DC to 1400 MHz			35.0	37.0		
1400 to 1475 MHz			30.0	34.0		
1475 to 1525 MHz			25.0	37.0		
1625 to 1640 MHz			30.0	45.0		
1640 to 2000 MHz			32.0	34.0		
2000 to 3000 MHz			20.0	28.0		
S_{11} VSWR across $f_C \pm 1.0$ MHz				1.2	2.0	
S_{22} VSWR across $f_C \pm 1.0$ MHz				1.2	2.0	
Source impedance	Z_S			50		Ω
Load impedance	Z_L			50		Ω
Operating Temperature	T_A		-40		+85	°C

Single-ended Input / Output Impedance Match	No matching network required for operation at 50 ohms
Case Style	SM2520-4
Lid Symbolization (Y=year, W=week)	2A, <u>YW</u>
Standard Reel Quality, 7 inch Reel Size	500 Pieces Reel
Standard Reel Quantity, 13 inch Reel Size	3000 Pieces/Reel

Electrical Connections

Connection	Terminals
Input	1
Output	3
Ground	All others

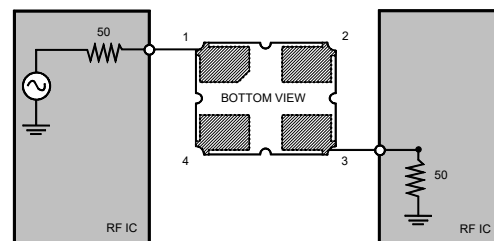

CAUTION: Electrostatic Sensitive Device. Observe precautions for handling.

NOTES:

1. The design, manufacturing process, and specifications of this device are subject to change.
2. US or International patents may apply.
3. RoHS compliant from the first date of manufacture.

11 Jun 2003 10:02:57
 [CH1] S31 L06 5 dB/REF -25 dB 47-50.418 dB 1.625.000 000 MHz

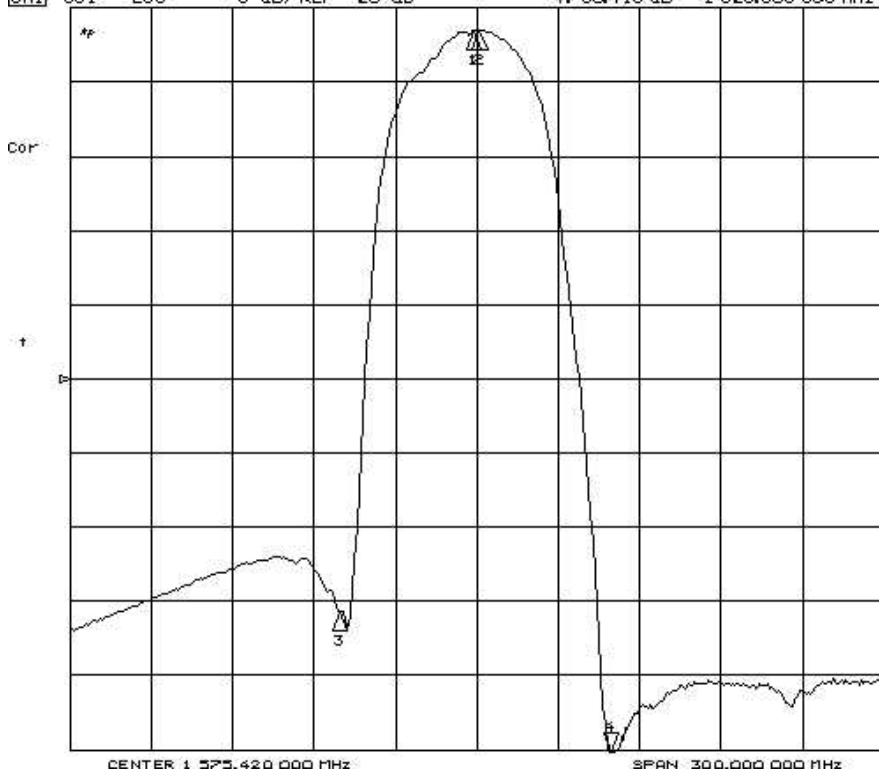

CH1 Markers
 1:-1.5373 dB
 1.52422 GHz
 2:-1.5102 dB
 1.52662 GHz
 3:-40.682 dB
 1.52500 GHz

11 Jun 2003 10:43:09

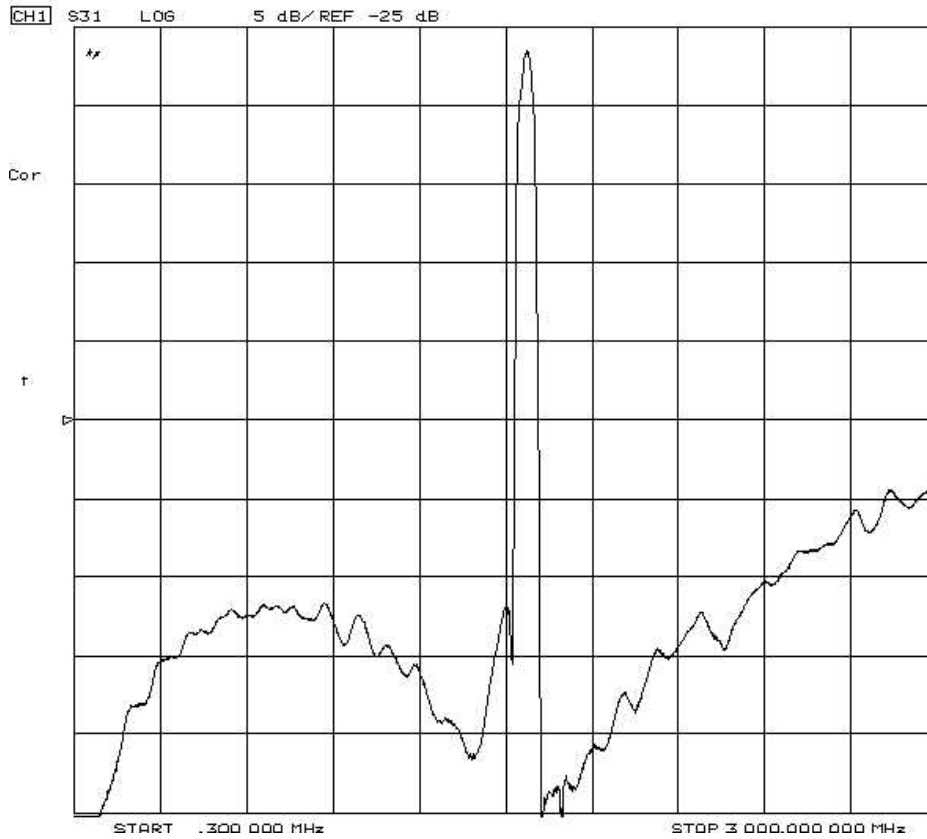

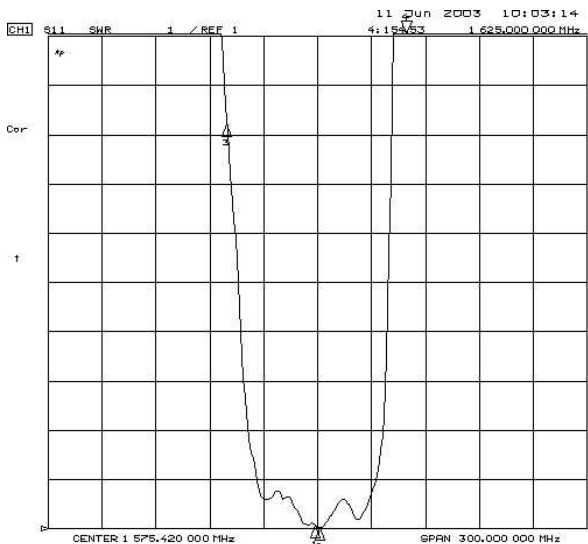

CH1 Markers
 1: 1.0649
 1.57422 GHz
 2: 1.0252
 1.57662 GHz
 3: 9.2329
 1.52500 GHz

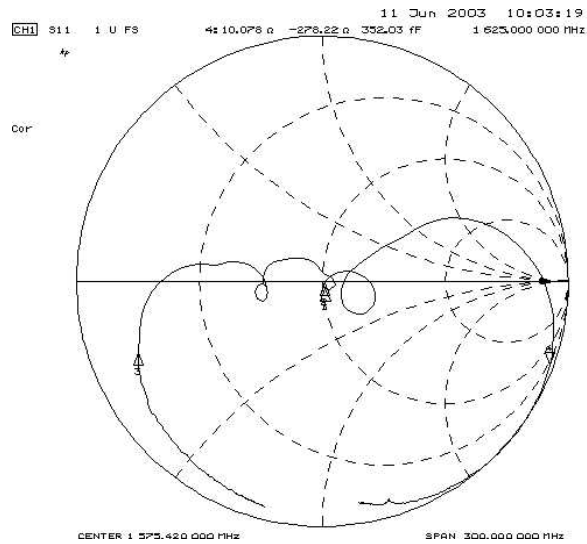

CH1 Markers
 1: 51.211 a
 -2.9629 a
 1.57422 GHz
 2: 51.002 a
 -667.97 na
 1.57662 GHz
 3: 5.6143 a
 -3.6334 a
 1.52500 GHz

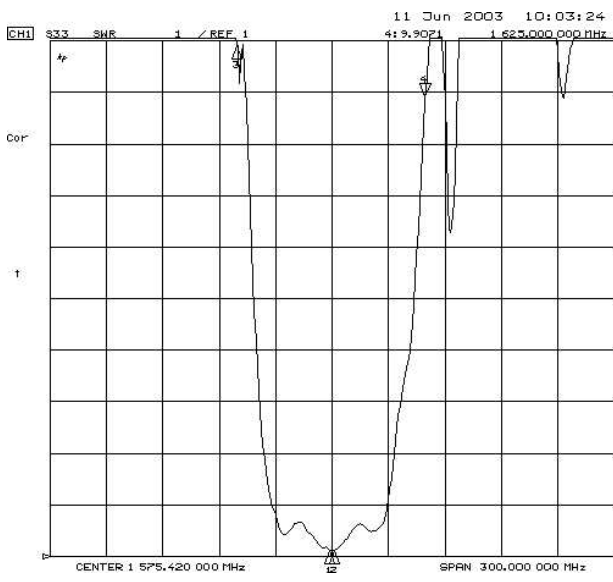

CH1 Markers
 1: 1.1199
 1.57422 GHz
 2: 1.1221
 1.57662 GHz
 3: 11.090
 1.52500 GHz

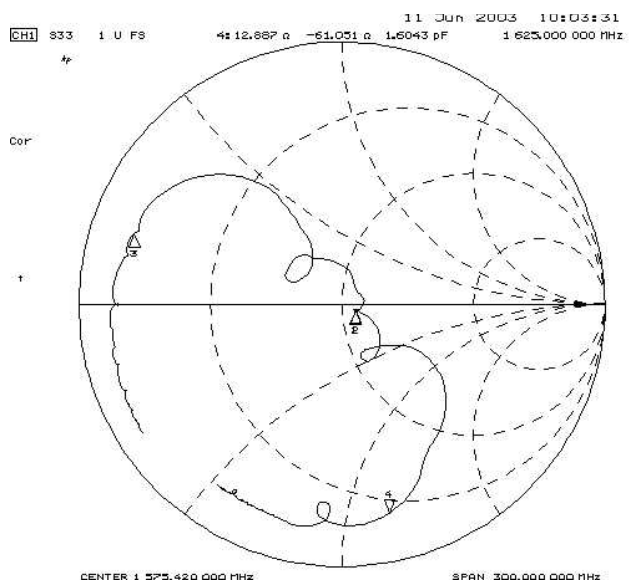

CH1 Markers
 1: 55.340 a
 -2.5137 a
 1.57422 GHz
 2: 55.604 a
 -2.3867 a
 1.57662 GHz
 3: 4.6333 a
 8.2703 a
 1.52500 GHz

SM2520-4 Case

4-Terminal Ceramic Surface-Mount Case

2.5 X 2.0 mm Nominal Footprint

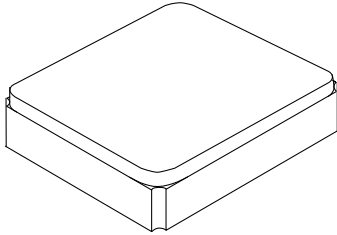

Case Dimensions

Dimension	mm		
	Min	Nom	Max
A	1.88	2.0	2.12
B	2.38	2.5	2.62
C			1.00
D	0.67	0.80	0.83
E	0.80	0.95	1.10
F	0.55	0.70	0.85
G	0.50	0.60	0.70

Electrical Connections

Connection		Terminals
Port 1	Single-ended Input	1
Port 2	Single-ended Output	3
	Ground	All others
Single-ended Operation Only		

Materials

Solder Pad Plating	0.3 to 1.0 μm Gold over 1.27 to 8.89 μm Nickel
Lid Plating	2.0 to 3.0 μm Nickel
Body	Al_2O_3 Ceramic

TOP VIEW

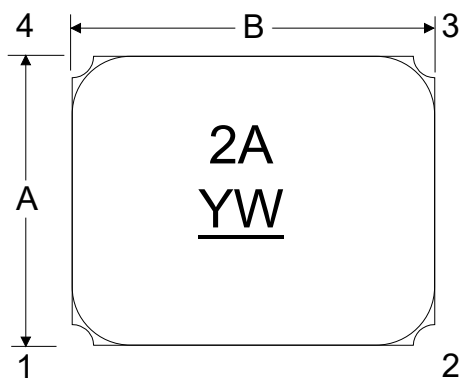

BOTTOM VIEW

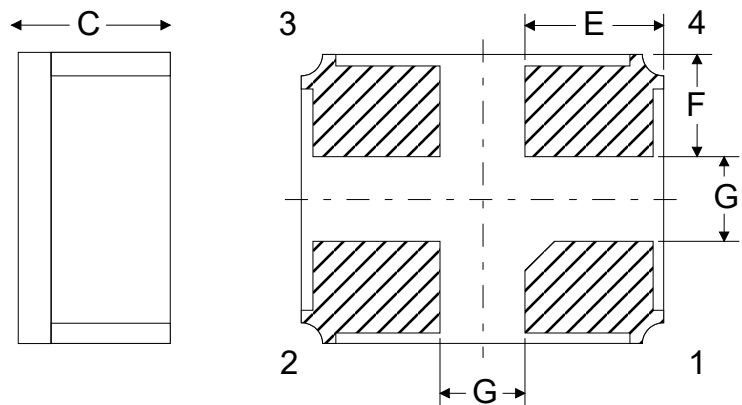

PCB Foot Print

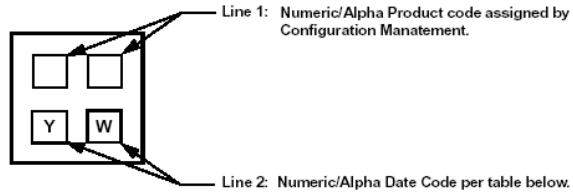
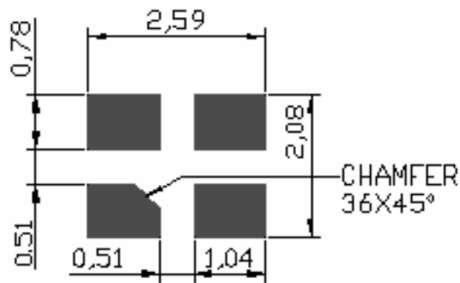

Table 4: SM2520-4

YEAR CODE		WEEK CODE							
NUMBER	REPRESENTS	ALPHA CHARACTER	REPRESENTS WEEK NO.	ALPHA CHARACTER	REPRESENTS WEEK NO.	ALPHA CHARACTER	REPRESENTS WEEK NO.	ALPHA CHARACTER	REPRESENTS WEEK NO.
3	2013	A	01	N	14	a	27	n	40
4	2014	B	02	O	15	b	28	o	41
5	2015	C	03	P	16	c	29	p	42
6	2016	D	04	Q	17	d	30	q	43
7	2017	E	05	R	18	e	31	r	44
8	2018	F	06	S	19	f	32	s	45
9	2019	G	07	T	20	g	33	t	46
0	2020	H	08	U	21	h	34	u	47
		I	09	V	22	i	35	v	48
		J	10	W	23	j	36	w	49
		K	11	X	24	k	37	x	50
		L	12	Y	25	l	38	y	51
		M	13	Z	26	m	39	z	52

Reel Dimension

Reel Count:
 7" = 2000
 13" = 10,000

Tape and Reel Standard per ANSI/EIA-481

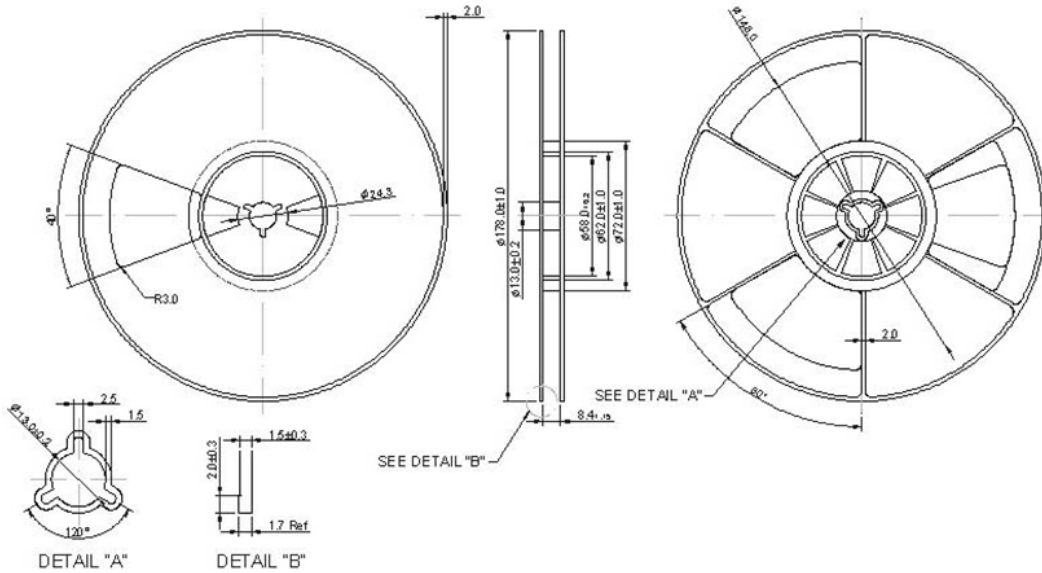

Tape Dimension

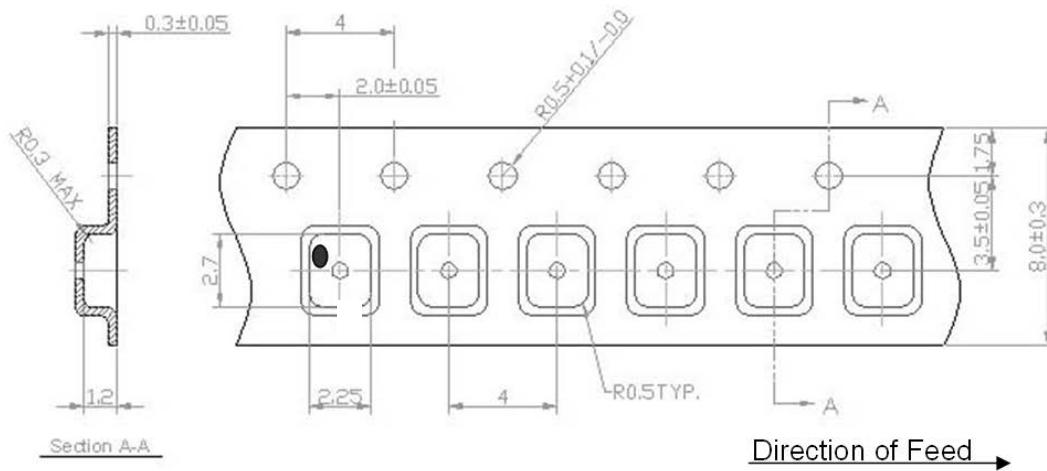

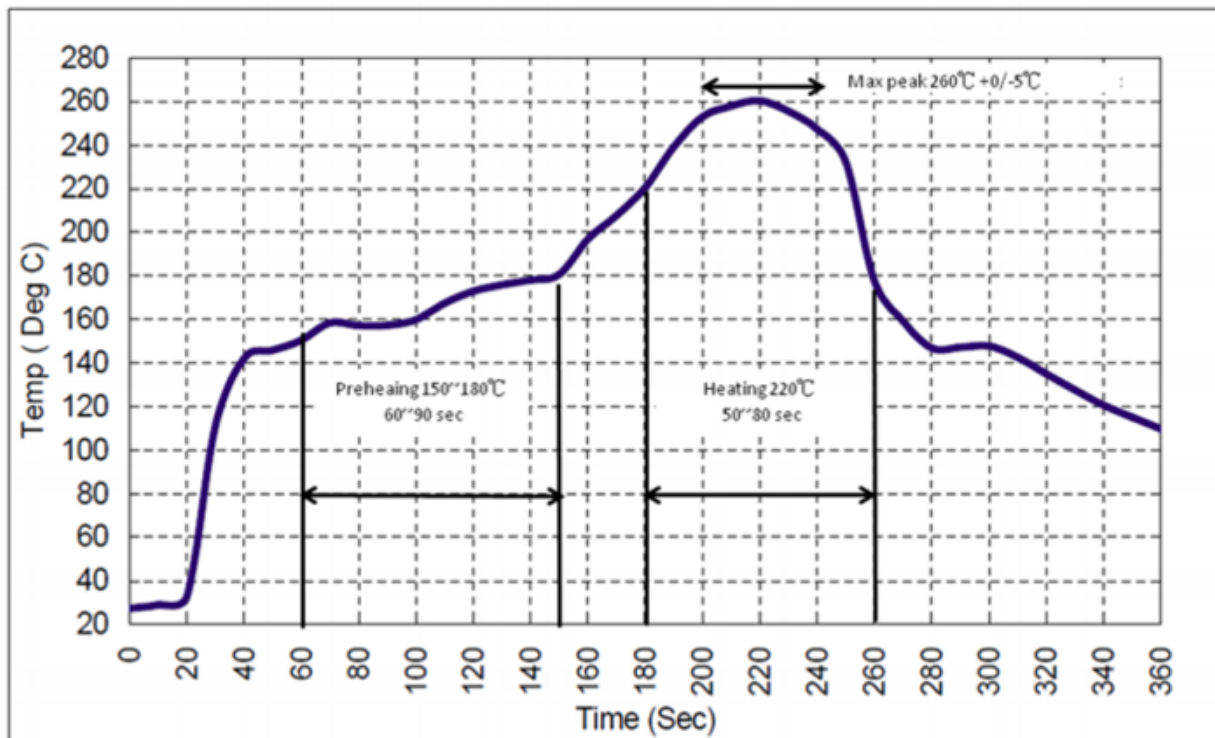

Recommended Reflow Profile

1. Preheating shall be fixed at 150~180°C for 60~90 seconds.
2. Ascending time to preheating temperature 150°C shall be 30 seconds min.
3. Heating shall be fixed at 220°C for 50~80 seconds and at 260°C+0/-5°C peak (10 seconds).
4. Time: 5 times maximum.



Looking for pricing, stock, or lifecycle information?

Click below to explore more details on WIN SOURCE:

-  [View SF1186G on WIN SOURCE](#)
-  [RF Monolithics, Inc Information](#)

Optimize Your Supply Chain with WIN SOURCE Solutions

-  Global Sourcing Solution
-  Obsolete Management
-  Cost Control Management
-  Shortage Management
-  Alternative Solution
-  Excess Inventory Management