



**THE DATASHEET OF
BD9206EFV-E2**



Simple Structure Constant Current Backlight Driver for LCD panels (Non-step type)

BD9206EFV

General Description

The BD9206EFV is an LED driver IC with a built-in 6-Ch high-accuracy constant-current driver (absolute accuracy: $\pm 4\%$). This LED driver is capable of lighting a maximum of 36 white LEDs (6 series x 6 parallel). The wide operating power supply voltage range of the BD9206EFV (8V to 30V) makes it suitable to be used in a wide range of applications (from backlights to LED light sources of Scanners and PPC's, etc.). Moreover, the BD9206EFV controls the generation of heat at the time of large current drive because of the adoption of the high-heat-radiation package (HTSSOP-B20).

Key Specifications

- Operating Power Supply Voltage Range: 8V to 30V
- Operating Current: 2.5mA (Typ)
- Maximum LED Constant Current: 30mA (Max)
- Operating Temperature Range: -40°C to $+85^{\circ}\text{C}$

Applications

For use in LED light source of PPC and Scanner etc., LED lighting fixture, and LCD backlight lights of monitor and note PC etc.

Features

- Capable of Driving a Maximum of 36 White LEDs of 6 Series x 6 Parallel
- Value of Constant Current is Set by the VSET Terminal
- Low Current Consumption during Standby
- PWM Dimming is Possible due to the Clock Input to the EN Terminal
- Built-in 5V Regulator

Package

W(Typ) x D(Typ) x H(Max)

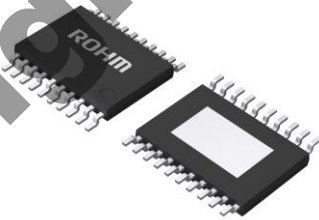

HTSSOP-B20
6.50mm x 6.40mm x 1.00mm
Pin Pitch: 0.65mm

Typical Application Circuit

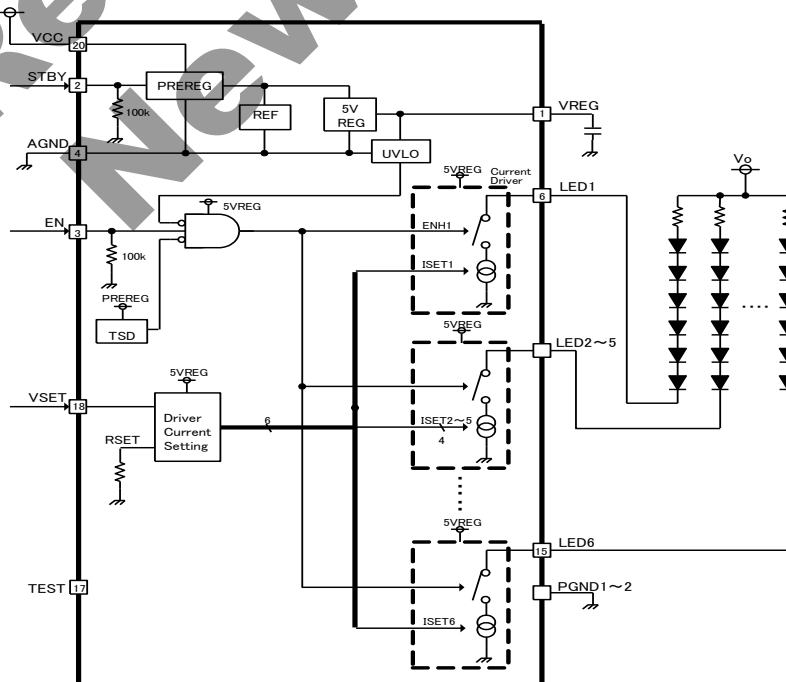

Absolute Maximum Ratings (Ta=25°C)

Item	Symbol	Rating	Unit
Power Supply Voltage	V _{CC}	36	V
LED Output voltage	V _{LED}	28	V
Power Dissipation	P _d	3.2 (Note 1)	W
Operational Temperature Range	T _{opr}	-40 to +85	°C
Storage Temperature Range	T _{stg}	-55 to +150	°C
LED Maximum Current	I _{LED}	30 (Note 2)	mA

(Note 1) Reduce by 25.6mW/°C for Ta above 25°C when mounted on a 4 layer 70mm x 70mm x 1.6mm glass epoxy PCB

(Note 2) Value per channel. Set within the given range in order to not exceed the package power dissipation.

Caution: Operating the IC over the absolute maximum ratings may damage the IC. The damage can either be a short circuit between pins or an open circuit between pins and the internal circuitry. Therefore, it is important to consider circuit protection measures such as adding a fuse, in case the IC is operated over the absolute maximum ratings.

Recommended Operating Conditions (Ta=25°C)

Item	Symbol	Rating	Unit
Power Supply Voltage	V _{CC}	8 to 30	V
EN Terminal Clock Input Frequency Range	V _{ENCLK}	100 to 10000	Hz
VSET Input Voltage Range	V _{SET}	0.6 to 3	V
Applied Voltage Range for LED Terminal	V _{LED}	0.6 to 28	V

Electrical Characteristics (Unless specified, Ta=25°C, V_{CC}=24V)

Item	Symbol	Rating			Unit	Conditions
		Min	Typ	Max		
【Whole】						
Circuit Electric Current when OFF	I _{OFF}	-	17	28	μA	STBY=L, EN=L, TEST=L
Circuit Electric Current During Standby	I _{ST}	-	1.8	3.6	mA	STBY=H, EN=L, TEST=L
Circuit Electric Current when Operating	I _{CC}	-	2.5	5.0	mA	STBY=H, EN=H, TEST=L
【LED Driver 1 to LED Driver 6】						
Output Current	I _{LED}	19.2	20.0	20.8	mA	V _{SET} =2.0V, V _{LED} =1V
Leak Electric Current when OFF	I _{LEDLK}	-	0.0	5.0	μA	V _{LED} =26V
Influx Electric Current to VSET Terminal	I _{INVSET}	-	-0.05	-0.10	μA	V _{SET} =2V
【VREG】						
Output Voltage	V _{REG}	4.7	5.0	5.3	V	I _{VREG} =1mA
Output Current	I _{OMAX}	10	30	-	mA	V _{REG} =V _{REG} X 0.9
【UVLO】						
Detection Voltage	V _{UVREG}	2.4	2.9	3.4	V	V _{REG} fall down
Hysteresis Voltage	V _{UHVREG}	0.05	0.1	0.2	V	V _{REG} rise up
【STBY, EN, TEST】						
Input Low Level	V _{IL}	-0.3	-	+0.8	V	
Input High Level	V _{IH}	2.0	-	V _{CC}	V	
Input Current	I _{IN}	33	47	66	μA	V _{IN} =3V

Pin Configuration

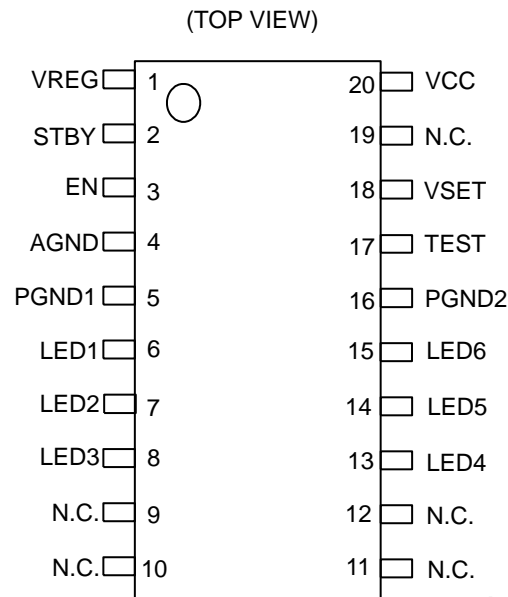

Pin Descriptions

Pin No.	Pin Name	Function	Pin No.	Pin Name	Function
1	VREG	Power supply for internal circuit	11	N.C.	No connection
2	STBY	Standby terminal (Low: OFF, High: standby, operation)	12	N.C.	No connection
3	EN	LED1 to LED6 Enable terminal(Active: High)	13	LED4	Output terminal 4 for LED driver
4	AGND	GND for internal standard section	14	LED5	Output terminal 5 for LED driver
5	PGND1	POWER GND for LED driver	15	LED6	Output terminal 6 for LED driver
6	LED1	Output terminal 1 for LED driver	16	PGND2	POWER GND for LED driver
7	LED2	Output terminal 2 for LED driver	17	TEST	Terminal for test mode shift (For normal operation : Low)
8	LED3	Output terminal 3 for LED driver	18	VSET	Standard voltage terminal for fixed electric current setting
9	N.C.	No connection	19	N.C.	No connection
10	N.C.	No connection	20	VCC	Terminal of power supply

I/O Equivalent Circuit

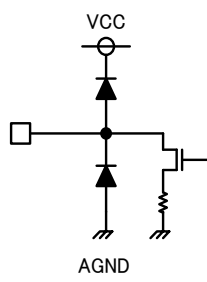
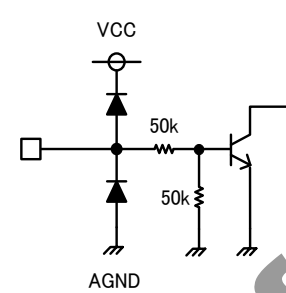
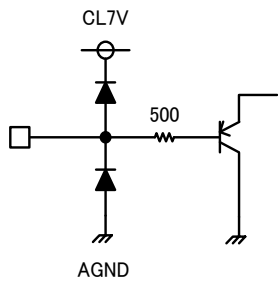
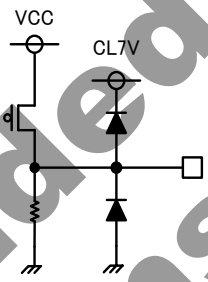
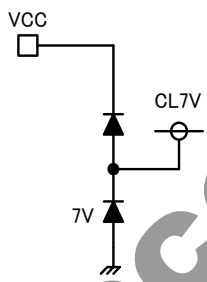
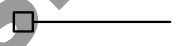
<p>6:LED1, 7:LED2, 8:LED3, 13:LED4, 14:LED5, 15:LED6</p> 	<p>2:STBY 3:EN, 17:TEST</p> 
<p>18:VSET</p> 	<p>1:VREG</p> 
<p>CL7V</p> 	<p>9, 10, 11, 12, 19:N.C.</p> <p>N.C. pin is not connected</p> 

Note: The voltage clamp element of 7V is connected to CL7V.

Figure 1. Pin ESD Type

Typical Performance Curves

(Unless specified, $V_{CC}=24V$, $T_a=25^{\circ}C$)

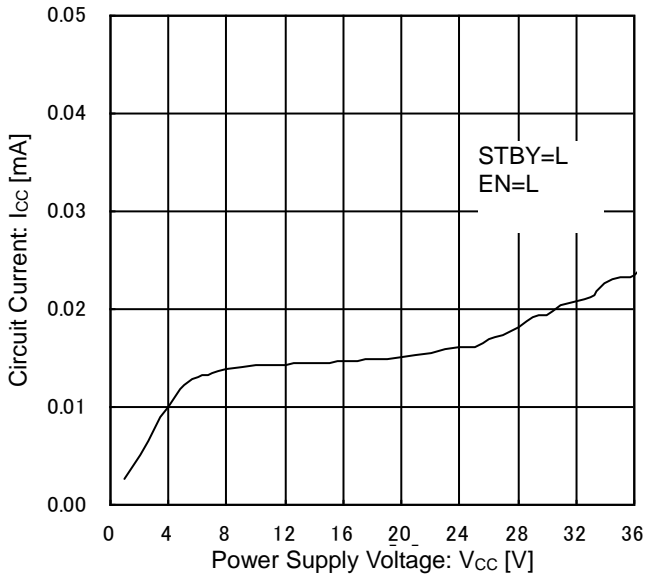

Figure 2. Circuit Current vs Power Supply Voltage (OFF Mode)

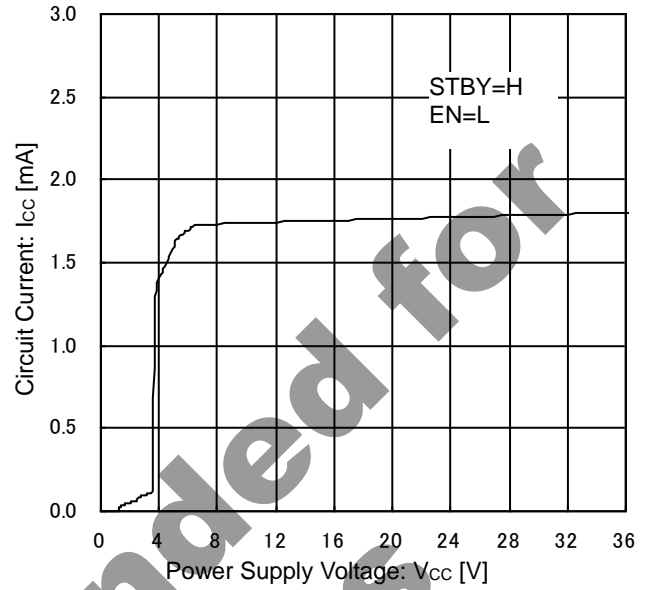

Figure 3. Circuit Current vs Power Supply Voltage (Standby Mode)

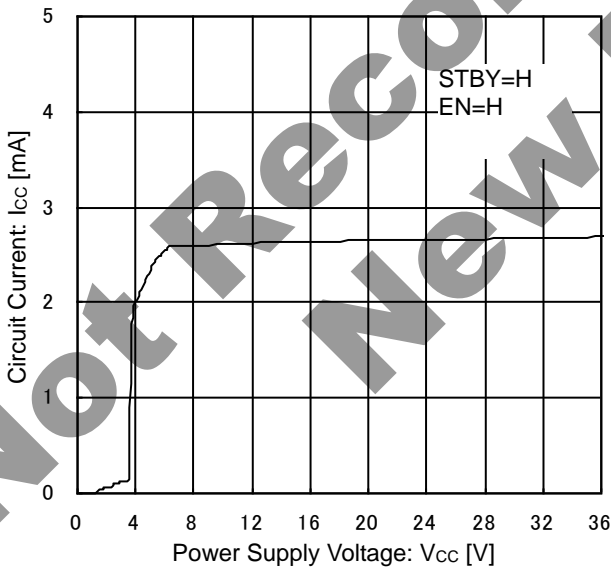

Figure 4. Circuit Current vs Power Supply Voltage (Operating Mode)

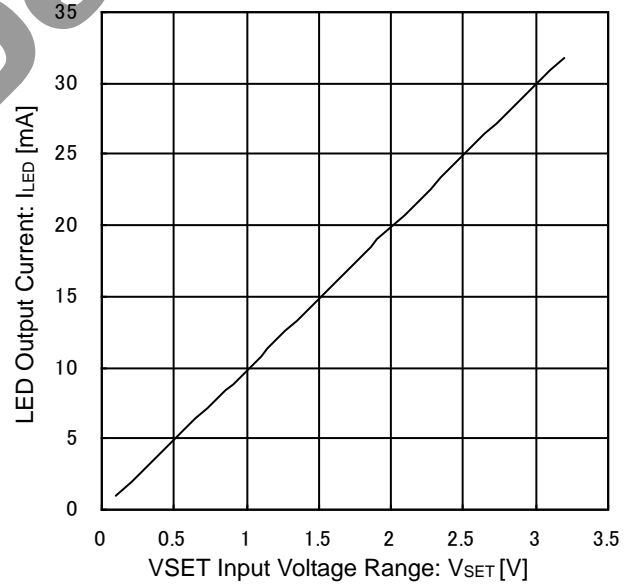

Figure 5. LED Output Current vs VSET Input Voltage Range (VSET Constant electric current Characteristics)

Typical Performance Curves - continued

(Unless specified, $V_{CC}=24V$, $T_a=25^{\circ}C$)

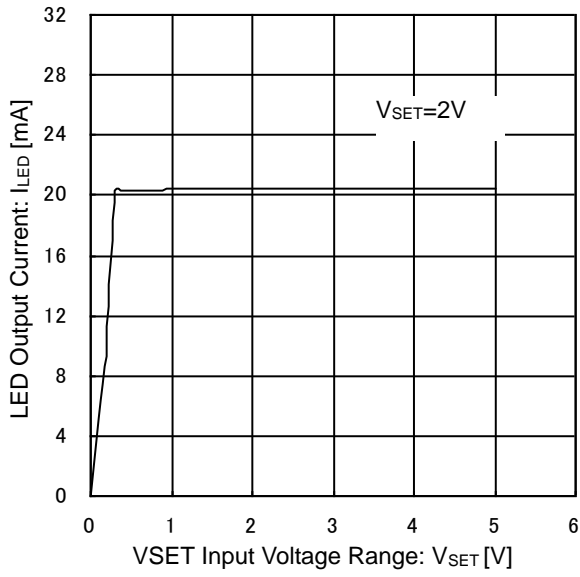

Figure 6. LED Output Current vs VSET Input Voltage Range (VLED Dependency of ILED)

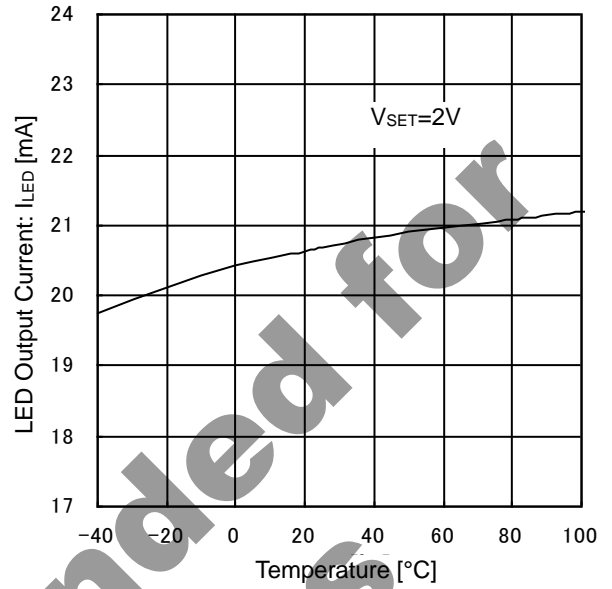

Figure 7. LED Output Current vs Temperature (Constant Electric Current Temperature Characteristic)

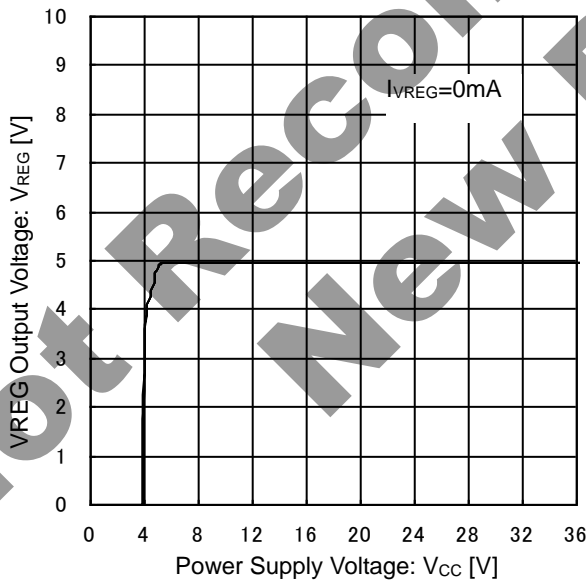

Figure 8. VREG Output Voltage vs Power Supply Voltage

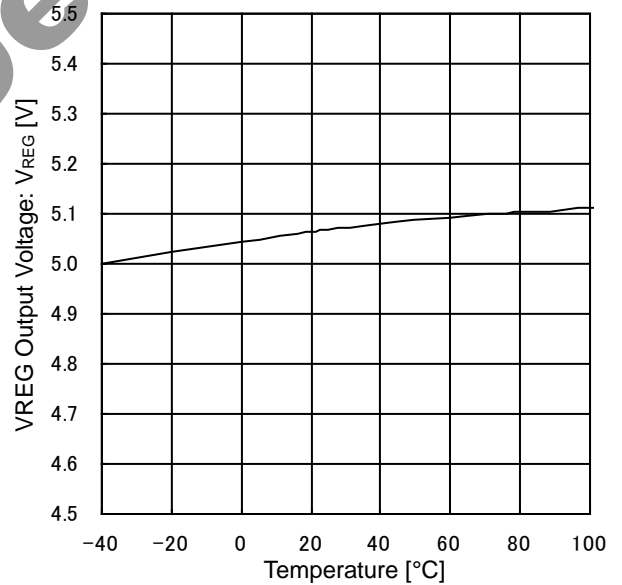

Figure 9. VREG Output Voltage vs Temperature

Typical Performance Curves - continued

(Unless specified, $V_{CC}=24V$, $T_a=25^{\circ}C$)

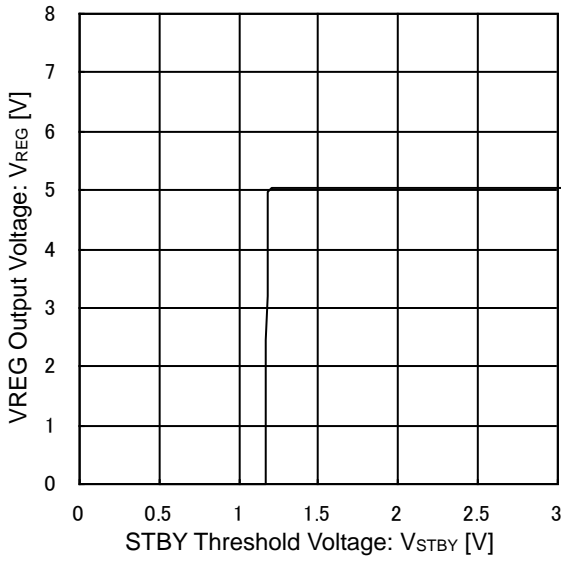

Figure 10. VREG Output Voltage vs STBY Threshold Voltage

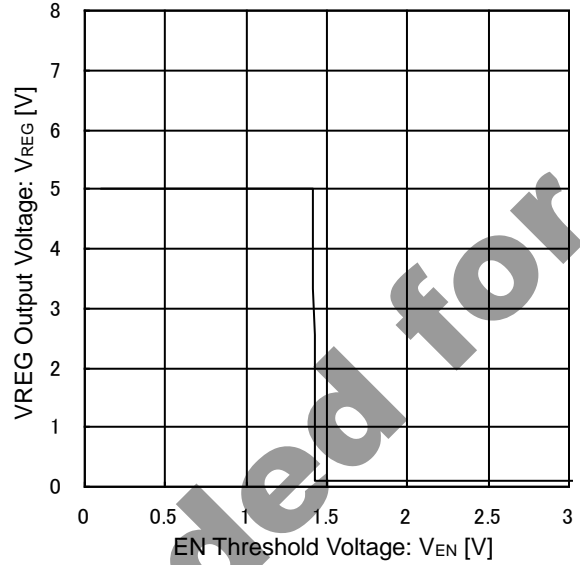
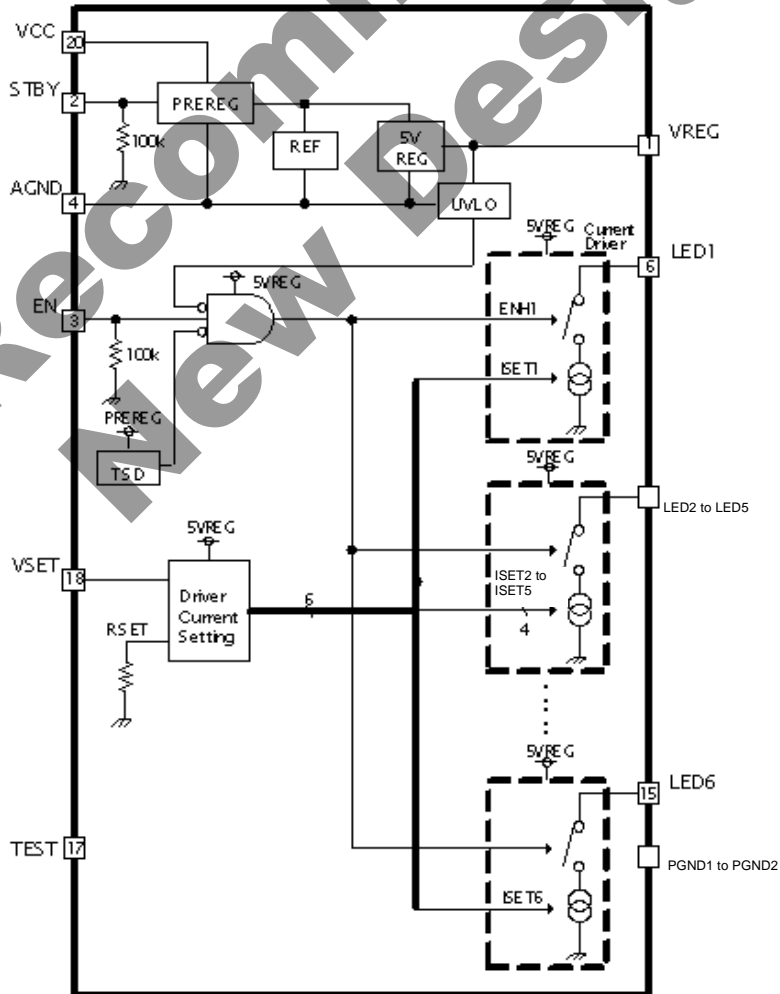

Figure 11. VREG Output Voltage vs EN Threshold Voltage

Block Diagram



Pin number 11pin

Application Information

1. Block Functional Descriptions

(1) PREREG, REF, 5VREG

The PREREG is a circuit that generates a constant voltage using the VCC supply voltage and supplies it to REF and 5VREG blocks.

The REF is a temperature-compensated reference voltage source. Its output is used as the reference voltage for the TSD (Thermal Shutdown Circuit) block.

The 5VREG is a 5V constant-voltage source. It is used as a power supply to the constant-current driver.

The 5V constant voltage is connected to the VREG terminal. Moreover, it is recommended to attach a 1 μ F ceramic capacitor to VREG terminal for phase compensation.

(2) UVLO (Under Voltage Lock Out)

The LED driver is turned OFF when the VREG voltage is less than 2.9V (typ). The operation resumes when VREG is more than 3.0V (typ).

(3) TSD (Thermal Shutdown Circuit)

The TSD circuit protects the IC from thermal damage.

This circuit detects the chip temperature and turns the circuit OFF when the chip temperature reaches 175°C.

A hysteresis of 20°C is set for TSD detection and release to prevent malfunction caused by temperature fluctuations.

(4) Current Driver (Constant-Current Driver), Driver Current Setting

The Current Driver (Constant-current driver) is a circuit that generates a constant current for turning ON the LEDs. The Constant-current circuit of BD9206EFV consists of the constant-current setting and the constant-current driver parts.

The constant-current driver part forces the voltage at point b to be equal to the voltage at point a, which is the voltage V_X that is set by the constant-current setting part.

Therefore, the current I_{LED} that flows into the VLED terminal is as follows:

$$I_{LED} = V_b / R_{SET} = V_a / R_{SET} = V_X / R_{SET} = V_{SET} \times A / R_{SET} = V_{SET} \times B$$

where:

A and B are numerical constants

For BD9206EFV, the numerical constants inside the IC are set to satisfy the equation below:

$$I_{LED}(\text{mA}) = V_{SET} \times 10 \quad (V_{SET}=0.6\text{V to }3.0\text{V})$$

If V_{SET} is fixed, then V_b is fixed, therefore the current I_{LED} always flows independently of the fixed voltage of V_{LED} .

However, the constant current operation is stopped if the voltage of VLED terminal is less than 0.6V,

so please ensure that $V_{LED} > 0.6\text{V}$.

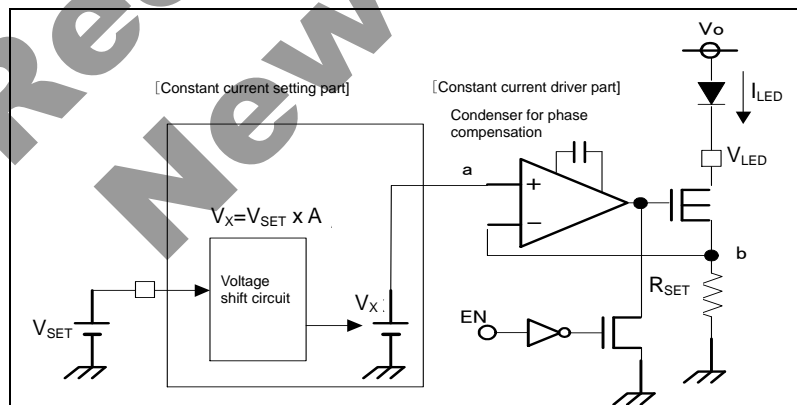

Figure 12

2. Rise Time and Fall Time of LED Driver's Constant Current

For STBY=H, the rise time of the constant-current at the time of EN=L to H and the fall time at the time of EN=H to L are shown in the following table.

As shown in Figure 12, the constant current driver is formed in such a way that the NMOS of the driver output is made to be operated or stopped by the EN signal.

Therefore, the rise time for the second time or later is shorter than the first one because the electrical charge of the capacitor for phase compensation is reopened from the charged state.

	First Time	Second Time or Later	Remarks
Rise Time	$2.9\mu\text{s} \pm 7\%$	$2.6\mu\text{s} \pm 7\%$	The time interval between the moment of EN=L to H and the moment at which the I _{LED} reaches 90% of the set value
Fall Time	$0.7\mu\text{s} \pm 11\%$	$0.7\mu\text{s} \pm 11\%$	The time interval between the moment of EN=H to L and the moment at which the I _{LED} reaches 10% of the set value

On the condition that $V_{CC}=V_O=24\text{V}$, $V_F(\text{LED})=3.2\text{V}$ 5-stage connection, $R_L=15\Omega$

(1) STBY, EN

When STBY=L, the IC enters the OFF mode. During OFF mode, only a portion of the circuit inside the IC is operating. Thus, the circuit current is limited to $17\mu\text{A}$ (typ).

At the time of STBY=H, it enters the Standby mode. 5VREG block is triggered and UVLO is released before the LED driver gets into the Ready-state

After that, if EN=L to H, then the current flows into the LED driver and the LED is turned ON.

Note: If STBY and EN are simultaneously turned from L to H, the rising edge of the LED driver will be late because of the starting time of 5VREG.

If it is used after PWM dimming, set STBY=H first then input the CLK to EN before use.

(a) Operation Logic of LED Driver

EN \ STBY	L	H
L	Stop	Stop
H	Stop	Operation

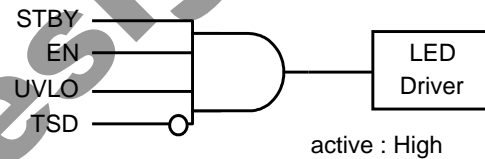

(b) Logic of LED Driver Protection Circuit

Function	Stop	Operation
UVLO	$V_{\text{REG}} < 2.9\text{V}(\text{typ})$	$V_{\text{REG}} > 3.0\text{V}(\text{typ})$
TSD	$T_a > 175^\circ\text{C}$	$T_a < 155^\circ\text{C}$

(2) TEST Terminal

TEST terminal is only used in ROHM's testing process before delivery. Use the IC with the TEST terminal fixed at Low in normal conditions.

3. Timing Chart

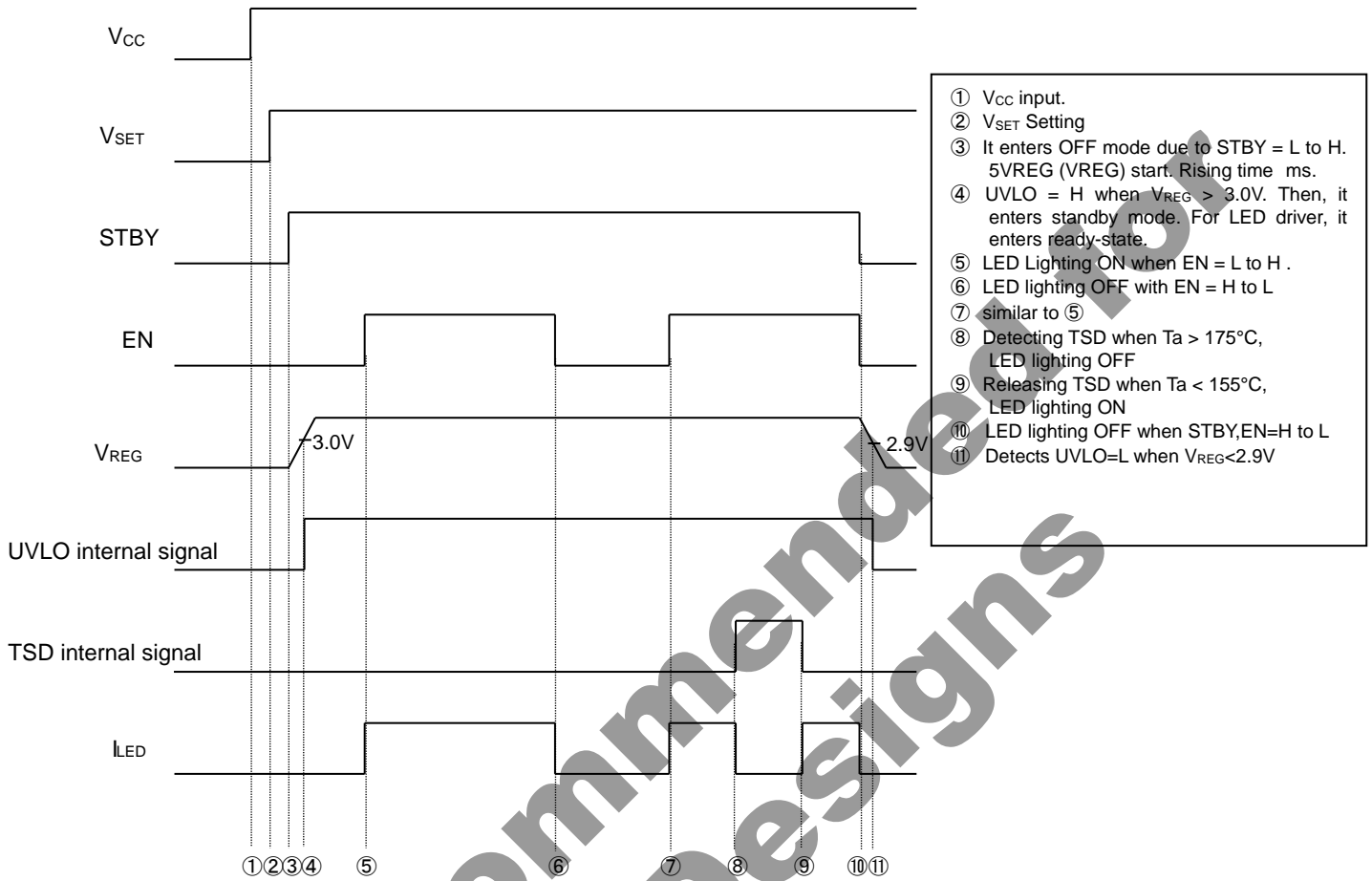

Figure 13

Note: Be careful of the current flowing to V_{CC} through the electrostatic breakdown protection diode when a voltage is applied to STBY terminal or EN terminal earlier than V_{CC} terminal.

4. Recommended Application Board Circuit

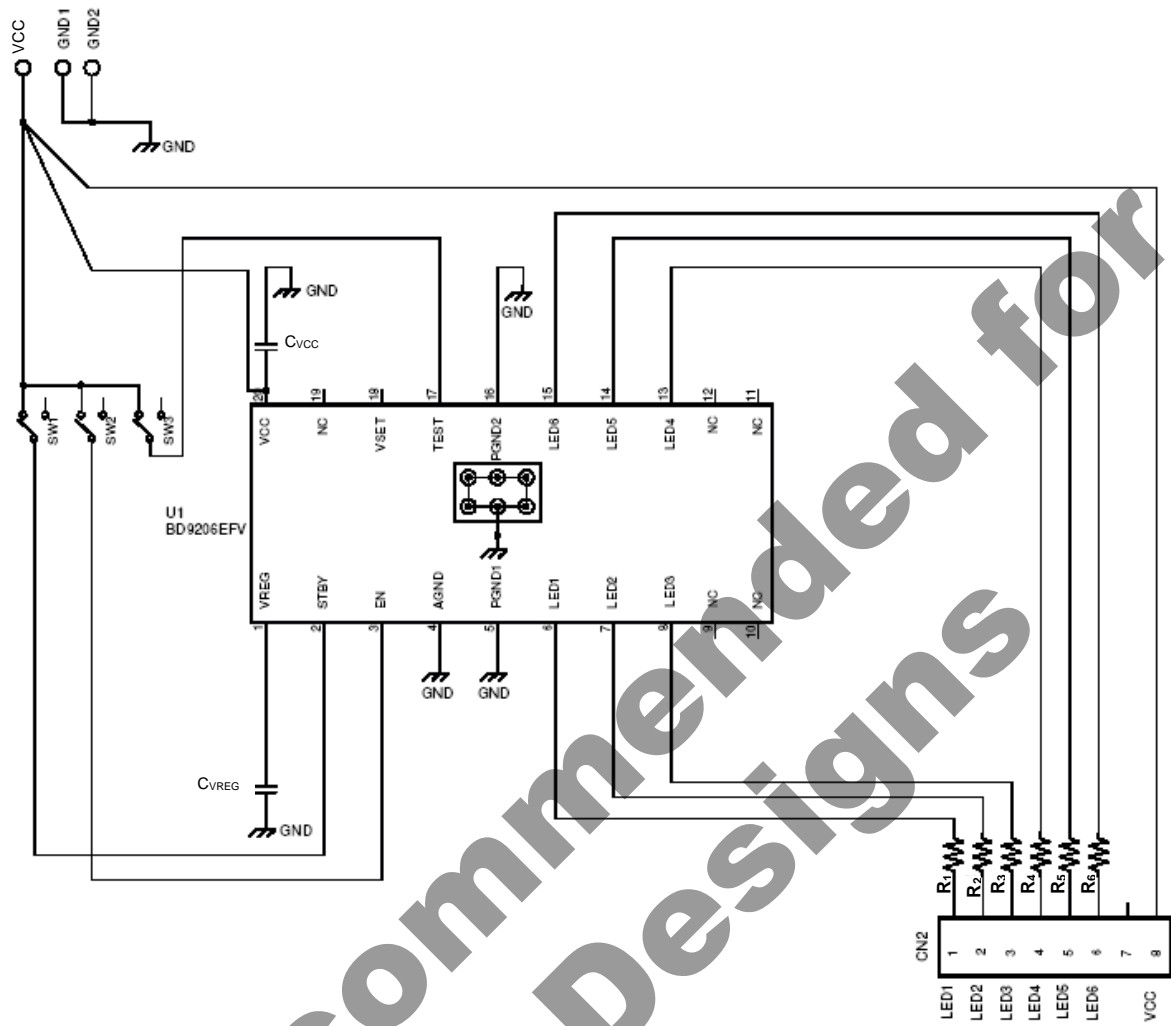

Figure 14

- (1) For this IC, at the time of LED lighting, the temperature of the package increases due to heat generation of the constant current driver. Therefore, attach a heat sink at the back of the package to the GND with wide substrate pattern.
- (2) In addition, the heat sinking can be further improved by putting a thermal VIA within. It can also be done by connecting the unconnected terminals, TEST terminals and unused terminals of LED1 to LED6 to GND.

5. Recommended External Components

When you use $V_{CC}=24V$ $I_{LED}=20mA$

Variety	Symbol	Usage	Type	Maker	Value	Unit
Resistance	R ₁ to R ₆	For reducing IC thermal loss	MCR03Series15R0	ROHM	15Ω	
Capacitor	C _{VCC}	For input bypass capacitor	GMR55DB31H106	murata	10uF	
	C _{VREG}	For VREG phase compensation	GMR188R71A105	murata	1uF	

6. Calculation of Electric Power Consumption for IC and the Deciding Method of External Resistance Value

Electric power consumption of IC is decided with formula below.

$$P(N) = I_{CC} \times V_{CC} + [(V_O - R_L \times I_{LED}) - (V_F + \Delta V_F + \Delta V_{FT}) \times M] \times N \times I_{LED} \quad \dots \textcircled{1}$$

Where:

- I_{CC} is the IC current consumption
- V_{CC} is the Input voltage
- V_F is the LED V_F voltage (normal temperature)
- ΔV_F is the LED V_F Variation
- ΔV_{FT} is the LED V_F Temperature variation
- M is the stage number around LED 1 line
- N is the LED line number
- I_{LED} is the LED Constant current value
- V_O is the Voltage of LED anode side
- R_L is the External resistance (external loss)

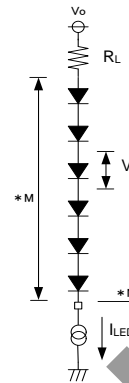

Figure 15

Please insert the heat-sink resistor R_L in order to decrease the heat generation of the IC. Increasing R_L , decreases the heat generated, but if the terminal voltage V_{LED} of the LED driver is less than 0.6V, then the constant current operation becomes impossible, therefore R_L has to be set to meet the condition below:

$$V_{LED} = V_O - (V_F + \Delta V_F + \Delta V_{FT}) \times M - R_L \times I_{LED} > 0.6V \quad \dots \textcircled{2}$$

Please set the I_{LED} and R_L in such a way that the relational expressions $\textcircled{1}$ & $\textcircled{2}$ are met. Moreover, the permissible loss of the package is shown in the graph below.

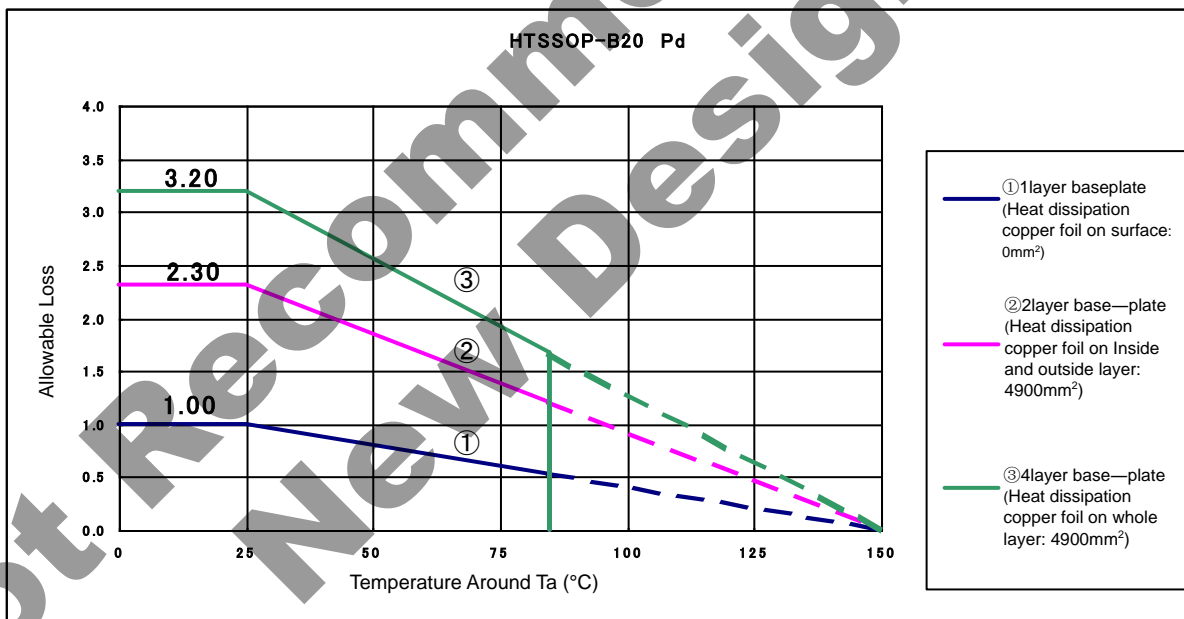

Figure 16

Operational Notes

1. Reverse Connection of Power Supply

Connecting the power supply in reverse polarity can damage the IC. Take precautions against reverse polarity when connecting the power supply, such as mounting an external diode between the power supply and the IC's power supply pins.

2. Power Supply Lines

Design the PCB layout pattern to provide low impedance supply lines. Separate the ground and supply lines of the digital and analog blocks to prevent noise in the ground and supply lines of the digital block from affecting the analog block. Furthermore, connect a capacitor to ground at all power supply pins. Consider the effect of temperature and aging on the capacitance value when using electrolytic capacitors.

3. Ground Voltage

Ensure that no pins are at a voltage below that of the ground pin at any time, even during transient condition.

4. Ground Wiring Pattern

When using both small-signal and large-current ground traces, the two ground traces should be routed separately but connected to a single ground at the reference point of the application board to avoid fluctuations in the small-signal ground caused by large currents. Also ensure that the ground traces of external components do not cause variations on the ground voltage. The ground lines must be as short and thick as possible to reduce line impedance.

5. Thermal Consideration

Should by any chance the power dissipation rating be exceeded the rise in temperature of the chip may result in deterioration of the properties of the chip. In case of exceeding this absolute maximum rating, increase the board size and copper area to prevent exceeding the Pd rating.

6. Recommended Operating Conditions

These conditions represent a range within which the expected characteristics of the IC can be approximately obtained. The electrical characteristics are guaranteed under the conditions of each parameter.

7. Inrush Current

When power is first supplied to the IC, it is possible that the internal logic may be unstable and inrush current may flow instantaneously due to the internal powering sequence and delays, especially if the IC has more than one power supply. Therefore, give special consideration to power coupling capacitance, power wiring, width of ground wiring, and routing of connections.

8. Operation Under Strong Electromagnetic Field

Operating the IC in the presence of a strong electromagnetic field may cause the IC to malfunction.

9. Testing on Application Boards

When testing the IC on an application board, connecting a capacitor directly to a low-impedance output pin may subject the IC to stress. Always discharge capacitors completely after each process or step. The IC's power supply should always be turned off completely before connecting or removing it from the test setup during the inspection process. To prevent damage from static discharge, ground the IC during assembly and use similar precautions during transport and storage.

10. Inter-pin Short and Mounting Errors

Ensure that the direction and position are correct when mounting the IC on the PCB. Incorrect mounting may result in damaging the IC. Avoid nearby pins being shorted to each other especially to ground, power supply and output pin. Inter-pin shorts could be due to many reasons such as metal particles, water droplets (in very humid environment) and unintentional solder bridge deposited in between pins during assembly to name a few.

Operational Notes – continued

11. Unused Input Pins

Input pins of an IC are often connected to the gate of a MOS transistor. The gate has extremely high impedance and extremely low capacitance. If left unconnected, the electric field from the outside can easily charge it. The small charge acquired in this way is enough to produce a significant effect on the conduction through the transistor and cause unexpected operation of the IC. So unless otherwise specified, unused input pins should be connected to the power supply or ground line.

12. Regarding the Input Pin of the IC

This monolithic IC contains P+ isolation and P substrate layers between adjacent elements in order to keep them isolated. P-N junctions are formed at the intersection of the P layers with the N layers of other elements, creating a parasitic diode or transistor. For example (refer to figure below):

When $GND > Pin A$ and $GND > Pin B$, the P-N junction operates as a parasitic diode.
When $GND > Pin B$, the P-N junction operates as a parasitic transistor.

Parasitic diodes inevitably occur in the structure of the IC. The operation of parasitic diodes can result in mutual interference among circuits, operational faults, or physical damage. Therefore, conditions that cause these diodes to operate, such as applying a voltage lower than the GND voltage to an input pin (and thus to the P substrate) should be avoided.

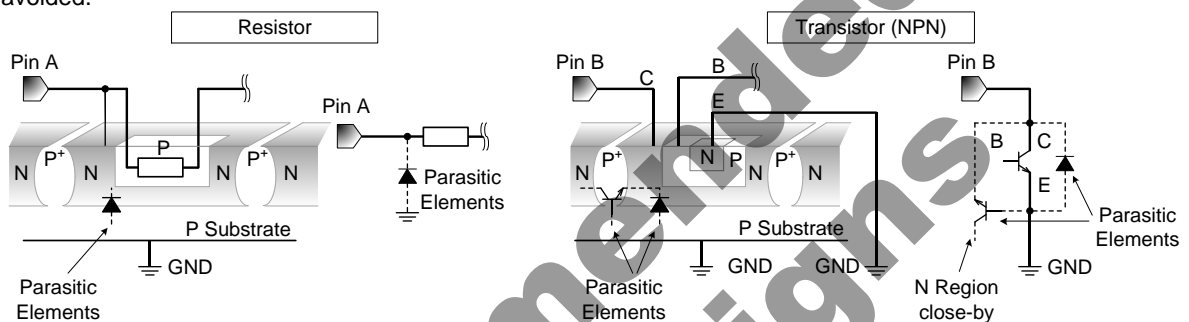

Figure 17. Example of monolithic IC structure

13. Area of Safe Operation (ASO)

Operate the IC such that the output voltage, output current, and power dissipation are all within the Area of Safe Operation (ASO).

14. Thermal Shutdown Circuit(TSD)

This IC has a built-in thermal shutdown circuit that prevents heat damage to the IC. Normal operation should always be within the IC's power dissipation rating. If however the rating is exceeded for a continued period, the junction temperature (T_j) will rise which will activate the TSD circuit that will turn OFF all output pins. When the T_j falls below the TSD threshold, the circuits are automatically restored to normal operation.

Note that the TSD circuit operates in a situation that exceeds the absolute maximum ratings and therefore, under no circumstances, should the TSD circuit be used in a set design or for any purpose other than protecting the IC from heat damage.

Ordering Information

B	D	9	2	0	6	E	F	V	-	E	2
---	---	---	---	---	---	---	---	---	---	---	---

Part Number	Package EFV: HTSSOP-B20	Packaging and forming specification E2: Embossed tape and reel
-------------	----------------------------	---

Marking Diagram

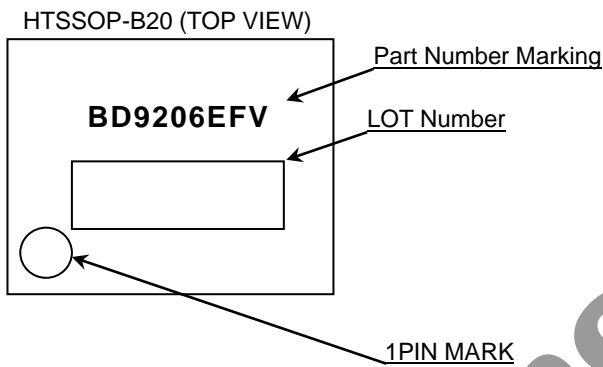

Not Recommended for New Designs

Physical Dimension, Tape and Reel Information

Package Name	HTSSOP-B20
--------------	------------

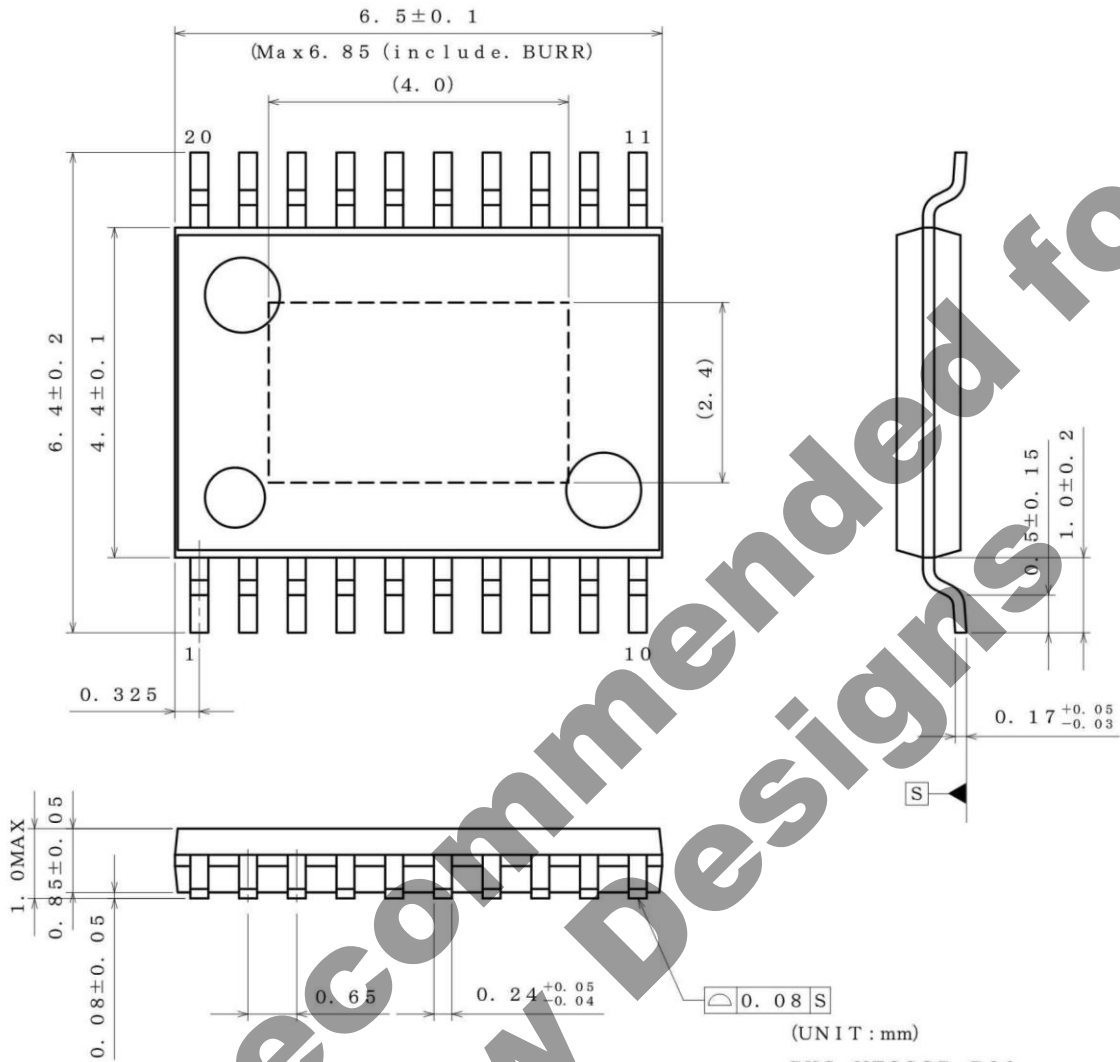

(UNIT : mm)
 PKG : HTSSOP-B20
 Drawing No. EX192-5002

<Tape and Reel information>

Tape	Embossed carrier tape (with dry pack)
Quantity	2500pcs
Direction of feed	E2 (The direction is the 1pin of product is at the upper left when you hold reel on the left hand and you pull out the tape on the right hand)

Diagram of the carrier tape showing the direction of feed and the location of the 1pin. The tape is shown with a series of components. The direction of feed is indicated by an arrow pointing to the right. The 1pin is indicated by an arrow pointing to the first component. A note states: *Order quantity needs to be multiple of the minimum quantity.

Revision History

Date	Revision	Changes
20.Sep.2012	001	New Release
09.Dec.2014	002	Applied the ROHM Standard Style and improved understandability.

**Not Recommended for
New Designs**

Notice

Precaution on using ROHM Products

- Our Products are designed and manufactured for application in ordinary electronic equipments (such as AV equipment, OA equipment, telecommunication equipment, home electronic appliances, amusement equipment, etc.). If you intend to use our Products in devices requiring extremely high reliability (such as medical equipment ^(Note 1), transport equipment, traffic equipment, aircraft/spacecraft, nuclear power controllers, fuel controllers, car equipment including car accessories, safety devices, etc.) and whose malfunction or failure may cause loss of human life, bodily injury or serious damage to property ("Specific Applications"), please consult with the ROHM sales representative in advance. Unless otherwise agreed in writing by ROHM in advance, ROHM shall not be in any way responsible or liable for any damages, expenses or losses incurred by you or third parties arising from the use of any ROHM's Products for Specific Applications.

(Note1) Medical Equipment Classification of the Specific Applications

JAPAN	USA	EU	CHINA
CLASS III	CLASS III	CLASS II b	CLASS III
CLASS IV		CLASS III	

- ROHM designs and manufactures its Products subject to strict quality control system. However, semiconductor products can fail or malfunction at a certain rate. Please be sure to implement, at your own responsibilities, adequate safety measures including but not limited to fail-safe design against the physical injury, damage to any property, which a failure or malfunction of our Products may cause. The following are examples of safety measures:
 - Installation of protection circuits or other protective devices to improve system safety
 - Installation of redundant circuits to reduce the impact of single or multiple circuit failure
- Our Products are designed and manufactured for use under standard conditions and not under any special or extraordinary environments or conditions, as exemplified below. Accordingly, ROHM shall not be in any way responsible or liable for any damages, expenses or losses arising from the use of any ROHM's Products under any special or extraordinary environments or conditions. If you intend to use our Products under any special or extraordinary environments or conditions (as exemplified below), your independent verification and confirmation of product performance, reliability, etc. prior to use, must be necessary:
 - Use of our Products in any types of liquid, including water, oils, chemicals, and organic solvents
 - Use of our Products outdoors or in places where the Products are exposed to direct sunlight or dust
 - Use of our Products in places where the Products are exposed to sea wind or corrosive gases, including Cl₂, H₂S, NH₃, SO₂, and NO₂
 - Use of our Products in places where the Products are exposed to static electricity or electromagnetic waves
 - Use of our Products in proximity to heat-producing components, plastic cords, or other flammable items
 - Sealing or coating our Products with resin or other coating materials
 - Use of our Products without cleaning residue of flux (even if you use no-clean type fluxes, cleaning residue of flux is recommended); or Washing our Products by using water or water-soluble cleaning agents for cleaning residue after soldering
 - Use of the Products in places subject to dew condensation
- The Products are not subject to radiation-proof design.
- Please verify and confirm characteristics of the final or mounted products in using the Products.
- In particular, if a transient load (a large amount of load applied in a short period of time, such as pulse. is applied, confirmation of performance characteristics after on-board mounting is strongly recommended. Avoid applying power exceeding normal rated power; exceeding the power rating under steady-state loading condition may negatively affect product performance and reliability.
- De-rate Power Dissipation (Pd) depending on Ambient temperature (Ta). When used in sealed area, confirm the actual ambient temperature.
- Confirm that operation temperature is within the specified range described in the product specification.
- ROHM shall not be in any way responsible or liable for failure induced under deviant condition from what is defined in this document.

Precaution for Mounting / Circuit board design

- When a highly active halogenous (chlorine, bromine, etc.) flux is used, the residue of flux may negatively affect product performance and reliability.
- In principle, the reflow soldering method must be used on a surface-mount products, the flow soldering method must be used on a through hole mount products. If the flow soldering method is preferred on a surface-mount products, please consult with the ROHM representative in advance.

For details, please refer to ROHM Mounting specification

Precautions Regarding Application Examples and External Circuits

1. If change is made to the constant of an external circuit, please allow a sufficient margin considering variations of the characteristics of the Products and external components, including transient characteristics, as well as static characteristics.
2. You agree that application notes, reference designs, and associated data and information contained in this document are presented only as guidance for Products use. Therefore, in case you use such information, you are solely responsible for it and you must exercise your own independent verification and judgment in the use of such information contained in this document. ROHM shall not be in any way responsible or liable for any damages, expenses or losses incurred by you or third parties arising from the use of such information.

Precaution for Electrostatic

This Product is electrostatic sensitive product, which may be damaged due to electrostatic discharge. Please take proper caution in your manufacturing process and storage so that voltage exceeding the Products maximum rating will not be applied to Products. Please take special care under dry condition (e.g. Grounding of human body / equipment / solder iron, isolation from charged objects, setting of Ionizer, friction prevention and temperature / humidity control).

Precaution for Storage / Transportation

1. Product performance and soldered connections may deteriorate if the Products are stored in the places where:
 - [a] the Products are exposed to sea winds or corrosive gases, including Cl₂, H₂S, NH₃, SO₂, and NO₂
 - [b] the temperature or humidity exceeds those recommended by ROHM
 - [c] the Products are exposed to direct sunshine or condensation
 - [d] the Products are exposed to high Electrostatic
2. Even under ROHM recommended storage condition, solderability of products out of recommended storage time period may be degraded. It is strongly recommended to confirm solderability before using Products of which storage time is exceeding the recommended storage time period.
3. Store / transport cartons in the correct direction, which is indicated on a carton with a symbol. Otherwise bent leads may occur due to excessive stress applied when dropping of a carton.
4. Use Products within the specified time after opening a humidity barrier bag. Baking is required before using Products of which storage time is exceeding the recommended storage time period.

Precaution for Product Label

QR code printed on ROHM Products label is for ROHM's internal use only.

Precaution for Disposition

When disposing Products please dispose them properly using an authorized industry waste company.

Precaution for Foreign Exchange and Foreign Trade act

Since our Products might fall under controlled goods prescribed by the applicable foreign exchange and foreign trade act, please consult with ROHM representative in case of export.

Precaution Regarding Intellectual Property Rights

1. All information and data including but not limited to application example contained in this document is for reference only. ROHM does not warrant that foregoing information or data will not infringe any intellectual property rights or any other rights of any third party regarding such information or data. ROHM shall not be in any way responsible or liable for infringement of any intellectual property rights or other damages arising from use of such information or data.:
2. No license, expressly or implied, is granted hereby under any intellectual property rights or other rights of ROHM or any third parties with respect to the information contained in this document.

Other Precaution

1. This document may not be reprinted or reproduced, in whole or in part, without prior written consent of ROHM.
2. The Products may not be disassembled, converted, modified, reproduced or otherwise changed without prior written consent of ROHM.
3. In no event shall you use in any way whatsoever the Products and the related technical information contained in the Products or this document for any military purposes, including but not limited to, the development of mass-destruction weapons.
4. The proper names of companies or products described in this document are trademarks or registered trademarks of ROHM, its affiliated companies or third parties.

General Precaution

1. Before you use our Products, you are requested to carefully read this document and fully understand its contents. ROHM shall not be in any way responsible or liable for failure, malfunction or accident arising from the use of any ROHM's Products against warning, caution or note contained in this document.
2. All information contained in this document is current as of the issuing date and subject to change without any prior notice. Before purchasing or using ROHM's Products, please confirm the latest information with a ROHM sales representative.
3. The information contained in this document is provided on an "as is" basis and ROHM does not warrant that all information contained in this document is accurate and/or error-free. ROHM shall not be in any way responsible or liable for any damages, expenses or losses incurred by you or third parties resulting from inaccuracy or errors of or concerning such information.

**Not Recommended for
New Designs**

Looking for pricing, stock, or lifecycle information?

Click below to explore more details on WIN SOURCE:

- ⊖ [View BD9206EFV-E2 on WIN SOURCE](#)
- ⊖ [Rohm Semiconductor](#) Information

Optimize Your Supply Chain with WIN SOURCE Solutions

- ✓ Global Sourcing Solution
- ✓ Obsolete Management
- ✓ Cost Control Management
- ✓ Shortage Management
- ✓ Alternative Solution
- ✓ Excess Inventory Management