

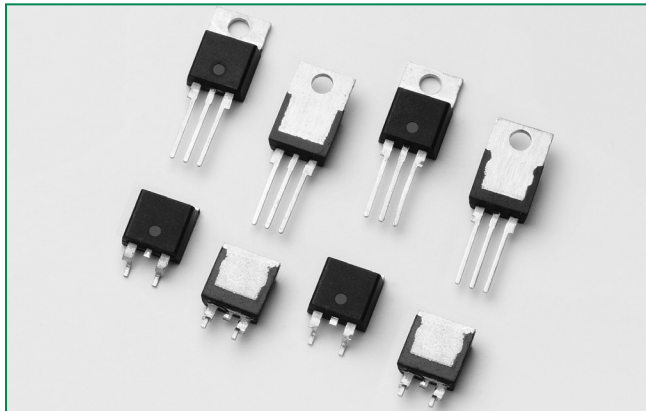

**THE DATASHEET OF
S8016R**



Sxx15x & Sxx16x Series



Description

The Sxx15x and Sxx16x Series provide excellent unidirectional switching for phase control applications such as heating and motor speed controls.

Standard phase control SCRs are triggered with few milliamperes of current at less than 1.5V potential.

Features & Benefits

- RoHS-compliant
- Glass – passivated junctions
- Voltage capability up to 1000 V
- Surge capability up to 225 A

Agency Approval

Agency	Agency File Number
	E71639*

* - L Packages Only

Applications

Typical applications are capacitive discharge systems for strobe lights, nailers, staplers and gas engine ignition. Also controls for power tools, home/brown goods and white goods appliances.

Internally constructed isolated packages are offered for ease of heat sinking with highest isolation voltage.

Main Features

Symbol	Value	Unit
$I_{T(RMS)}$	15 & 16	A
V_{DRM}/V_{RRM}	400 to 1000	V
I_{GT}	30	mA

Schematic Symbol

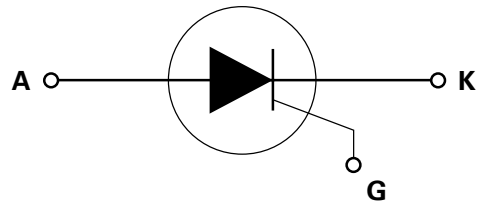

Absolute Maximum Ratings – Standard SCRs

Symbol	Parameter	Test Conditions		Value	Unit
		Model	Temperature		
$I_{T(RMS)}$	RMS on-state current	Sxx15L	$T_c = 90^\circ\text{C}$	15	A
		Sxx16R Sxx16N	$T_c = 110^\circ\text{C}$	16	
$I_{T(AV)}$	Average on-state current	Sxx15L	$T_c = 90^\circ\text{C}$	9.5	A
		Sxx16R Sxx16N	$T_c = 110^\circ\text{C}$	10.0	
I_{TSM}	Peak non-repetitive surge current	single half cycle; $f = 50\text{Hz}$; $T_j(\text{initial}) = 25^\circ\text{C}$		188	A
		single half cycle; $f = 60\text{Hz}$; $T_j(\text{initial}) = 25^\circ\text{C}$		225	
I^2t	I^2t Value for fusing	$t_p = 8.3 \text{ ms}$		210	A^2s
di/dt	Critical rate of rise of on-state current	$f = 60 \text{ Hz}; T_j = 125^\circ\text{C}$		125	$\text{A}/\mu\text{s}$
I_{GM}	Peak gate current	$T_j = 125^\circ\text{C}$		3	A
$P_{G(AV)}$	Average gate power dissipation	$T_j = 125^\circ\text{C}$		0.6	W
T_{stg}	Storage temperature range			-40 to 150	$^\circ\text{C}$
T_j	Operating junction temperature range			-40 to 125	$^\circ\text{C}$

Note: xx = voltage

Electrical Characteristics ($T_J = 25^\circ\text{C}$, unless otherwise specified)

Symbol	Test Conditions			Value		Unit
				Sxx15x	Sxx16x	
I_{GT}	$V_D = 12V$ $R_L = 60\ \Omega$	-	MAX.	30		mA
		-	MAX.	1		V
V_{GT}	$V_D = 12V$ $R_L = 60\ \Omega$	-	MAX.	1.5		V
dv/dt	$V_D = V_{DRM}$; gate open; $T_J = 100^\circ\text{C}$	400V	MIN.	450	V/ μs	
		600V		425		
		800V		400		
		1000V		200		
	$V_D = V_{DRM}$; gate open; $T_J = 125^\circ\text{C}$	400V		350		
		600V		325		
V_{GD}	$V_D = V_{DRM}$ $R_L = 3.3\ \text{k}\Omega$ $T_J = 110^\circ\text{C}$	-	MIN.	0.2		V
I_H	$I_T = 200\text{mA}$ (initial)	-	MAX.	40		mA
t_q	$I_T = 2\text{A}$; $t_p = 50\ \mu\text{s}$; $dv/dt = 5\text{V}/\mu\text{s}$; $di/dt = -30\text{A}/\mu\text{s}$	-	MAX.	35		μs
t_{gt}	$I_G = 2 \times I_{GT}$ $PW = 15\ \mu\text{s}$ $I_T = 12\text{A}$	-	TYP.	2		μs

Note: xx = voltage, x = package
 (1) $I_T = 2\text{A}$; $t_p = 50\ \mu\text{s}$; $dv/dt = 5\text{V}/\mu\text{s}$; $di/dt = -30\text{A}/\mu\text{s}$

Static Characteristics

Symbol	Test Conditions			Value	Unit	
V_{TM}	15A Device $I_T = 30\text{A}$; $t_p = 380\ \mu\text{s}$			MAX.	1.6	V
	16A Device $I_T = 32\text{A}$; $t_p = 380\ \mu\text{s}$					
I_{DRM} / I_{RRM}	$V_{DRM} = V_{RRM}$	$T_J = 25^\circ\text{C}$	400 - 600V	MAX.	10	μA
			800 - 1000V		20	
		$T_J = 100^\circ\text{C}$	400 - 600V		500	
			800V		1000	
		$T_J = 125^\circ\text{C}$	1000V		3000	
			400 - 600V		1000	
		800V	2000			

Thermal Resistances

Symbol	Parameter	Value	Unit
$R_{\theta(J-C)}$	Junction to case (AC)	Sxx16R/ Sxx16N	1.1
		Sxx15L	2.5
$R_{\theta(J-A)}$	Junction to ambient	Sxx16R/Sxx16N	40
		Sxx15L	50

Note: xx = voltage

Figure 1: Normalized DC Gate Trigger Current vs. Junction Temperature

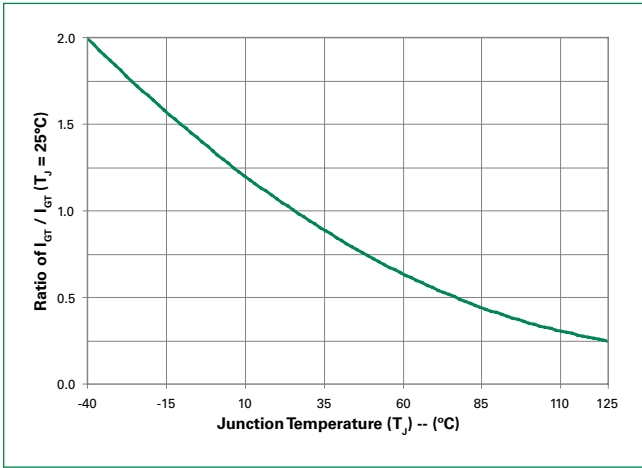

Figure 2: Normalized DC Gate Trigger Voltage vs. Junction Temperature

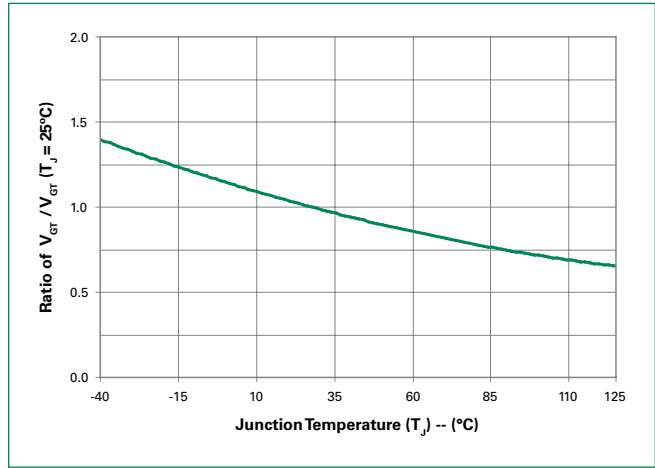

Figure 3: Normalized DC Holding Current vs. Junction Temperature

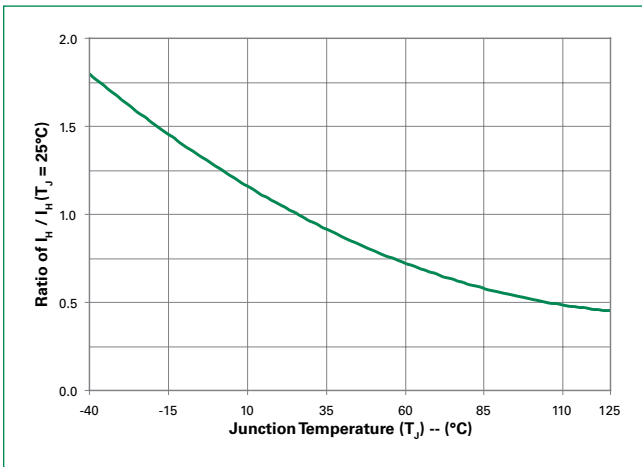

Figure 4: On-State Current vs. On-State Voltage (Typical)

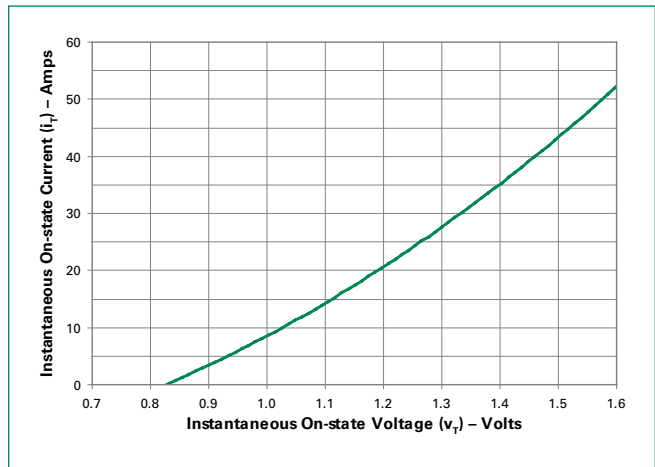

Figure 5: Power Dissipation (Typical) vs. RMS On-State Current

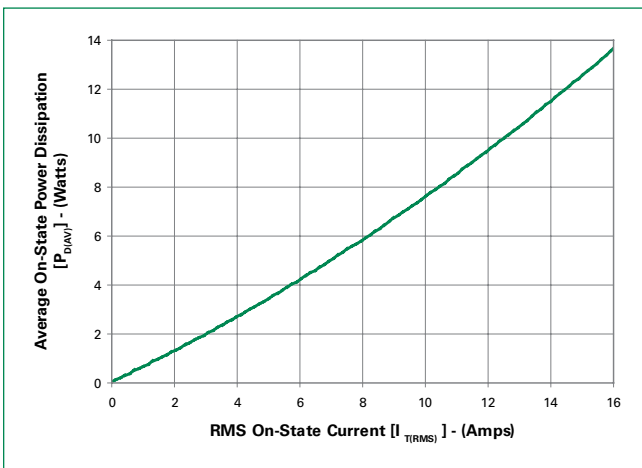

Figure 6: Maximum Allowable Case Temperature vs. RMS On-State Current

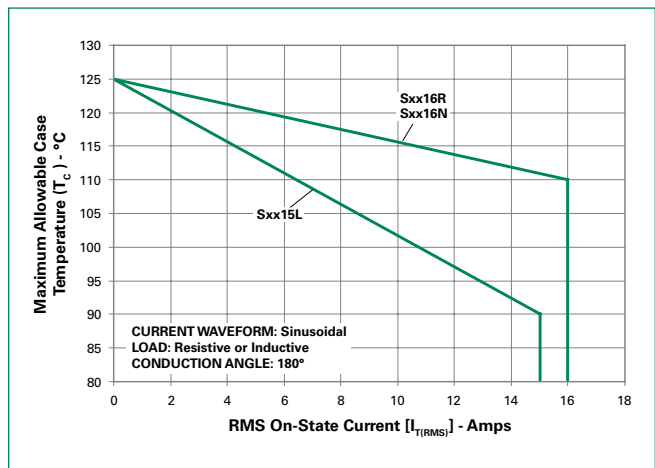

Figure 7: Maximum Allowable Case Temperature vs. Average On-State Current

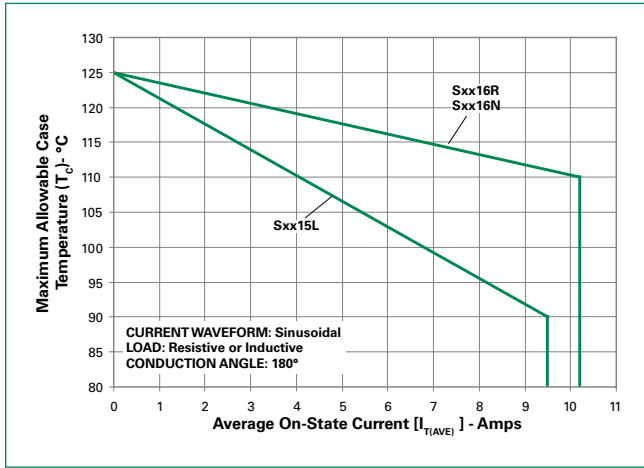

Figure 8: Maximum Allowable Ambient Temperature vs. RMS On-State Current

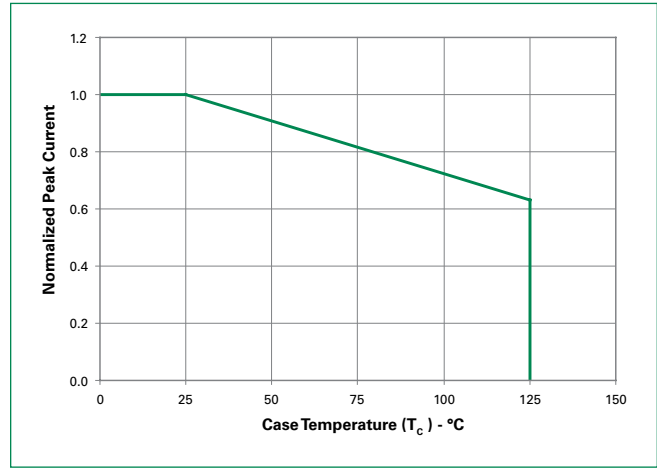
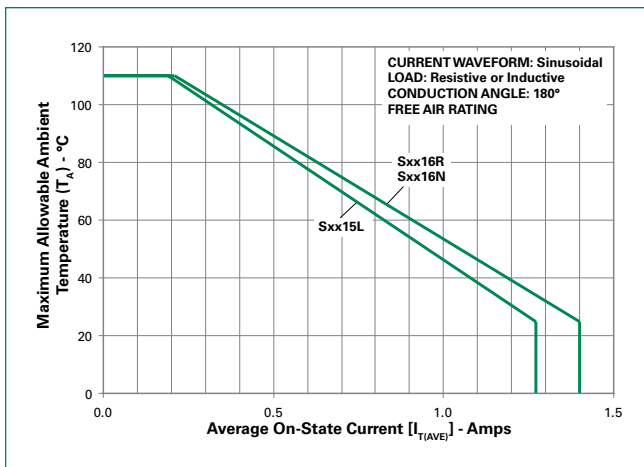

Figure 9: Maximum Allowable Ambient Temperature vs. Average On-State Current



Note: xx = voltage

Figure 10: Peak Capacitor Discharge Current

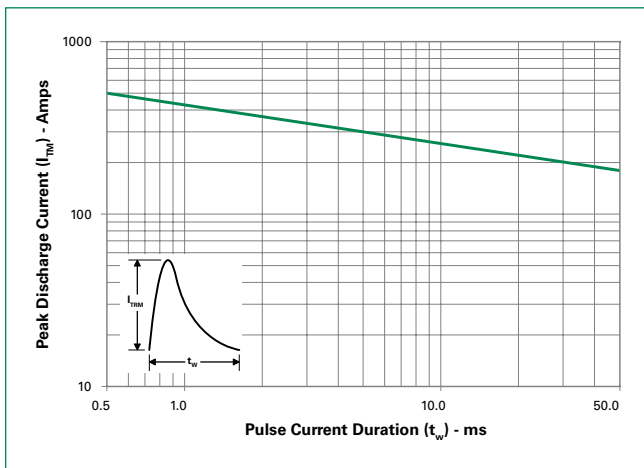

Figure 11: Peak Capacitor Discharge Current Derating

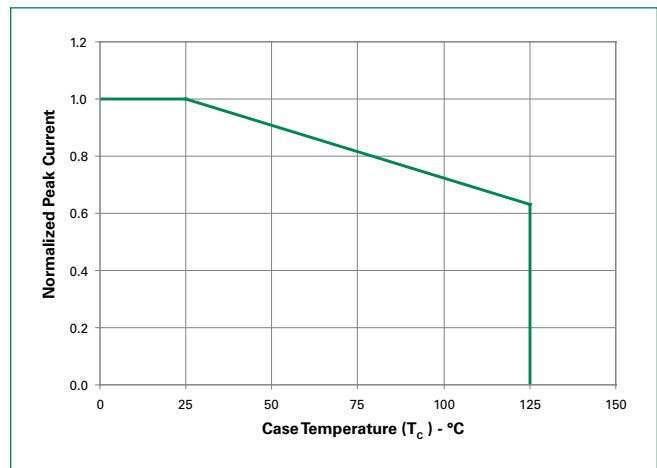
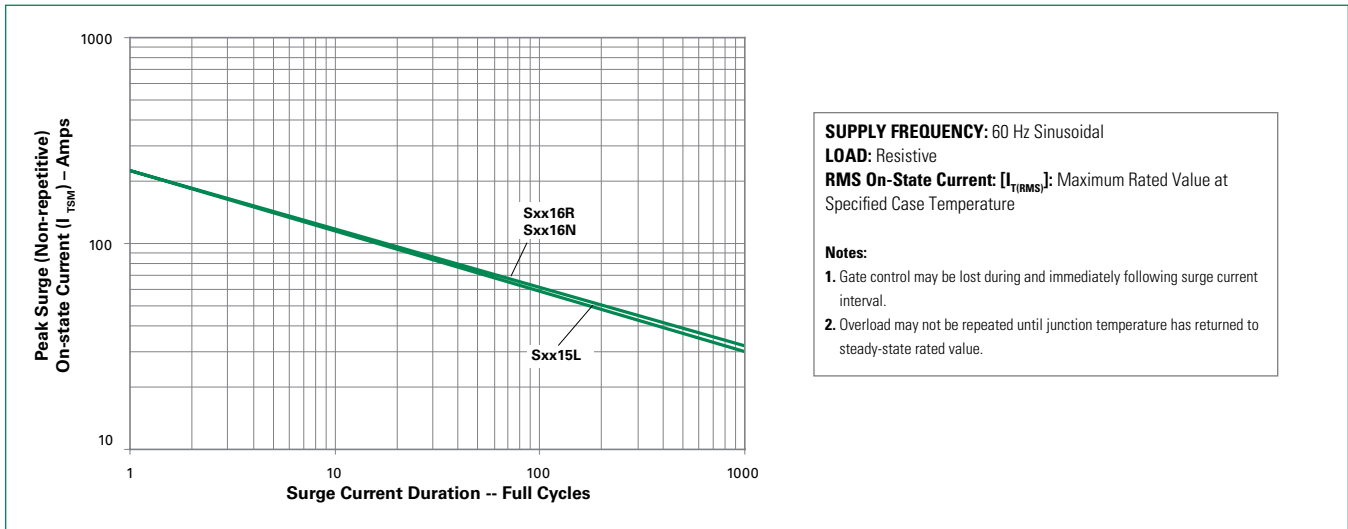
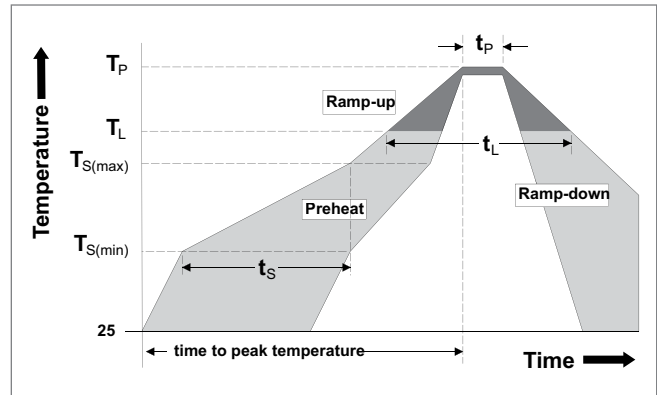

Figure 12: Surge Peak On-State Current vs. Number of Cycles



Soldering Parameters

Reflow Condition		Pb – Free assembly
Pre Heat	- Temperature Min ($T_{s(min)}$)	150°C
	- Temperature Max ($T_{s(max)}$)	200°C
	- Time (min to max) (t_s)	60 – 180 secs
Average ramp up rate (Liquidus Temp) (T_L) to peak		5°C/second max
$T_{S(max)}$ to T_L - Ramp-up Rate		5°C/second max
Reflow	- Temperature (T_L) (Liquidus)	217°C
	- Temperature (t_L)	60 – 150 seconds
Peak Temperature (T_p)		260 ^{+0/-5} °C
Time within 5°C of actual peak Temperature (t_p)		20 – 40 seconds
Ramp-down Rate		5°C/second max
Time 25°C to peak Temperature (T_p)		8 minutes Max.
Do not exceed		280°C



Additional Information



Datasheet



Resources



Samples

Physical Specifications

Terminal Finish	100% Matte Tin-plated
Body Material	UL Recognized epoxy meeting flammability classification 94V-0
Lead Material	Copper Alloy

Design Considerations

Careful selection of the correct device for the application's operating parameters and environment will go a long way toward extending the operating life of the Thyristor. Good design practice should limit the maximum continuous current through the main terminals to 75% of the device rating. Other ways to ensure long life for a power discrete semiconductor are proper heat sinking and selection of voltage ratings for worst case conditions. Overheating, overvoltage (including dv/dt), and surge currents are the main killers of semiconductors. Correct mounting, soldering, and forming of the leads also help protect against component damage.

Environmental Specifications

Test	Specifications and Conditions
AC Blocking	MIL-STD-750, M-1040, Cond A Applied Peak AC voltage @ 125°C for 1008 hours
Temperature Cycling	MIL-STD-750, M-1051, 100 cycles; -40°C to +150°C; 15-min dwell-time
Temperature/Humidity	EIA / JEDEC, JESD22-A101 1008 hours; 320V - DC: 85°C; 85% rel humidity
High Temp Storage	MIL-STD-750, M-1031, 1008 hours; 150°C
Low-Temp Storage	1008 hours; -40°C
Resistance to Solder Heat	MIL-STD-750 Method 2031
Solderability	ANSI/J-STD-002, category 3, Test A
Lead Bend	MIL-STD-750, M-2036 Cond E

Dimensions – TO-220AB (R-Package) – Non-Isolated Mounting Tab Common with Center Lead

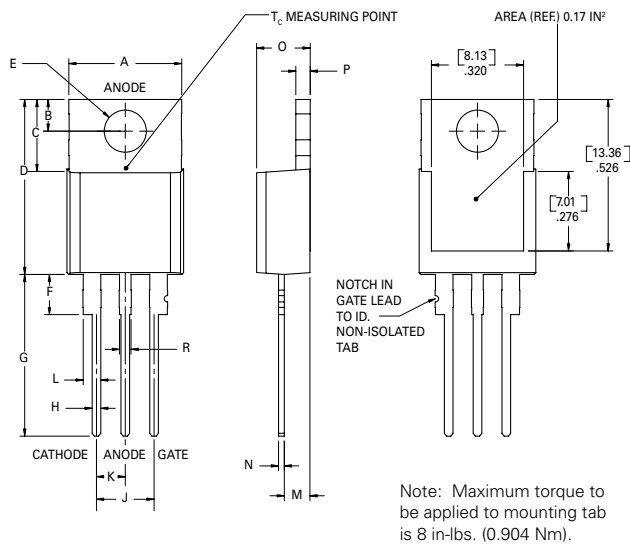

Dimension	Inches		Millimeters	
	Min	Max	Min	Max
A	0.380	0.420	9.65	10.67
B	0.105	0.115	2.67	2.92
C	0.230	0.250	5.84	6.35
D	0.590	0.620	14.99	15.75
E	0.142	0.147	3.61	3.73
F	0.110	0.130	2.79	3.30
G	0.540	0.575	13.72	14.61
H	0.025	0.035	0.64	0.89
J	0.195	0.205	4.95	5.21
K	0.095	0.105	2.41	2.67
L	0.060	0.075	1.52	1.91
M	0.085	0.095	2.16	2.41
N	0.018	0.024	0.46	0.61
O	0.178	0.188	4.52	4.78
P	0.045	0.060	1.14	1.52
R	0.038	0.048	0.97	1.22

Dimensions — TO-220AB (L-Package) — Isolated Mounting Tab

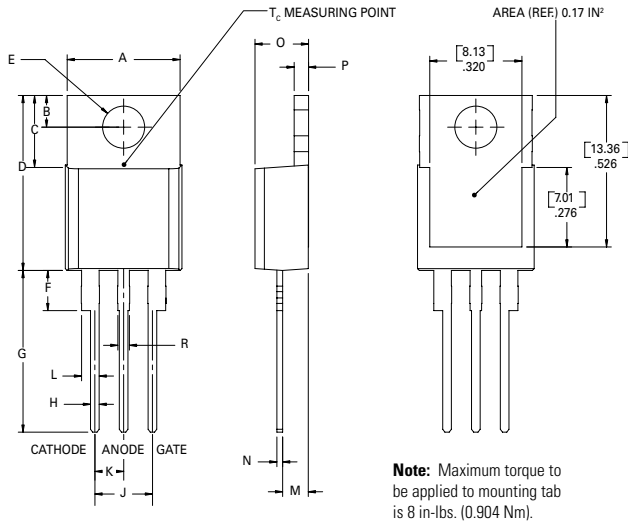

Dimension	Inches		Millimeters	
	Min	Max	Min	Max
A	0.380	0.420	9.65	10.67
B	0.105	0.115	2.67	2.92
C	0.230	0.250	5.84	6.35
D	0.590	0.620	14.99	15.75
E	0.142	0.147	3.61	3.73
F	0.110	0.130	2.79	3.30
G	0.540	0.575	13.72	14.61
H	0.025	0.035	0.64	0.89
J	0.195	0.205	4.95	5.21
K	0.095	0.105	2.41	2.67
L	0.060	0.075	1.52	1.91
M	0.085	0.095	2.16	2.41
N	0.018	0.024	0.46	0.61
O	0.178	0.188	4.52	4.78
P	0.045	0.060	1.14	1.52
R	0.038	0.048	0.97	1.22

Dimensions — TO-263AB (N-package) — D²-Pak Surface Mount

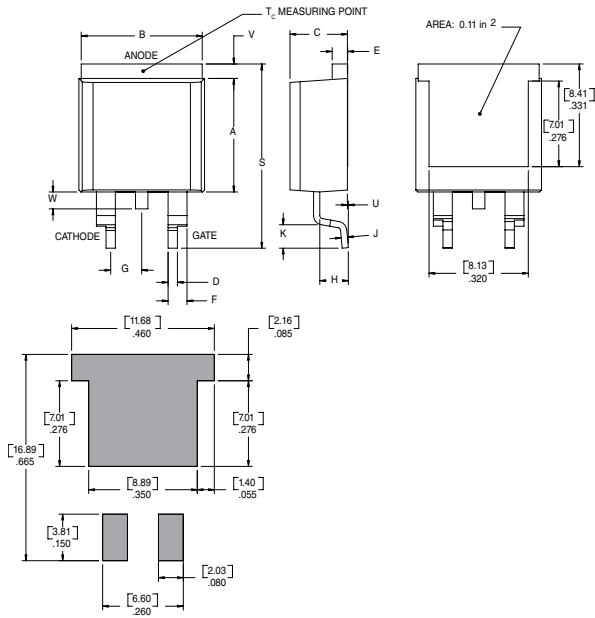

Dimension	Inches		Millimeters	
	Min	Max	Min	Max
A	0.360	0.370	9.14	9.40
B	0.380	0.420	9.65	10.67
C	0.178	0.188	4.52	4.78
D	0.025	0.035	0.64	0.89
E	0.045	0.060	1.14	1.52
F	0.060	0.075	1.52	1.91
G	0.095	0.105	2.41	2.67
H	0.092	0.102	2.34	2.59
J	0.018	0.024	0.46	0.61
K	0.090	0.110	2.29	2.79
S	0.590	0.625	14.99	15.88
V	0.035	0.045	0.89	1.14
U	0.002	0.010	0.05	0.25
W	0.040	0.070	1.02	1.78

Product Selector

Part Number	Voltage				Gate Sensitivity	Type	Package
	400V	600V	800V	1000V			
Sxx15L	X	X	X	X	30mA	Standard SCR	TO-220L
Sxx16R	X	X	X	X	30mA	Standard SCR	TO-220R
Sxx16N	X	X	X	X	30mA	Standard SCR	TO-263

Note: xx = Voltage

Packing Options

Part Number	Marking	Weight	Packing Mode	Base Quantity
Sxx15LTP	Sxx15L	2.2 g	Tube	1000 (50 per tube)
Sxx16RTP	Sxx16R	2.2 g	Tube	1000 (50 per tube)
Sxx16NTP	Sxx16N	1.6 g	Tube	1000 (50 per tube)
Sxx16NRP	Sxx16N	1.6 g	Embossed Carrier	500

Note: xx = Voltage

TO-263 Embossed Carrier Reel Pack (RP) Specs

Meets all EIA-481-2 Standards

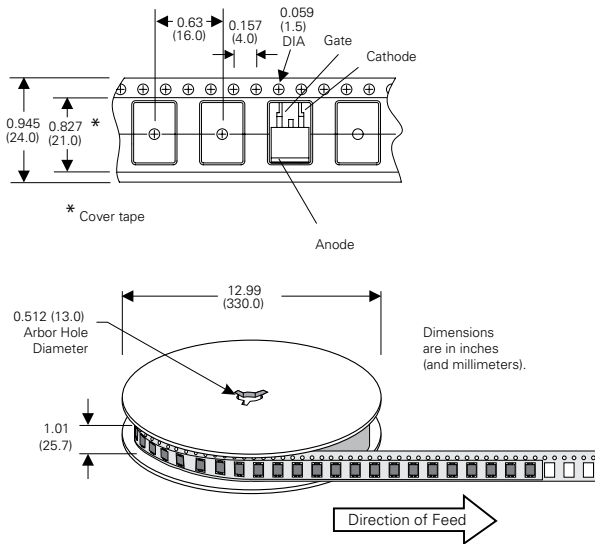

Part Marking System

TO-220 AB - (L and R Package)
TO-263 AB - (N Package)

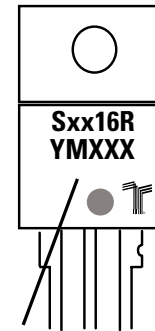

Date Code Marking
Y: Year Code
M: Month Code
XXX: Lot Trace Code

Part Numbering System

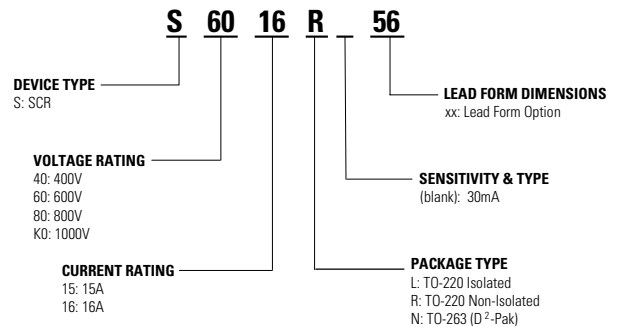

Disclaimer Notice - Information furnished is believed to be accurate and reliable. However, users should independently evaluate the suitability of and test each product selected for their own applications. Littelfuse products are not designed for, and may not be used in, all applications. Read complete Disclaimer Notice at <http://www.littelfuse.com/disclaimer-electronics>.

Looking for pricing, stock, or lifecycle information?

Click below to explore more details on WIN SOURCE:

 [View S8016R on WIN SOURCE](#)

 [Littelfuse Inc. Information](#)

Optimize Your Supply Chain with WIN SOURCE Solutions

-  Global Sourcing Solution
-  Obsolete Management
-  Cost Control Management
-  Shortage Management
-  Alternative Solution
-  Excess Inventory Management