



**THE DATASHEET OF
AP3615FNTR-G1**



OBSOLETE - PART DISCONTINUED

Description

The AP3615 is a step-up DC-DC converter based on 1x/1.5x charge pump and low dropout current sink, which helps it maintain the highest efficiency. The AP3615 is specially designed to drive up to 5 WLEDs in backlight display.

The AP3615 provides up to 20mA current for each WLED. There are totally 16 steps of current control, which is achieved through a digital pulse dimming function on EN pin. Additionally, 1MHz high switching frequency enables the use of small external capacitors. Internal soft-start circuitry prevents excessive inrush current during start-up and mode transition.

The supply voltage of AP3615 ranges from 2.8V to 5.5V which make it ideally suit for applications powered by Li-ion battery.

The AP3615 is available in the tiny package of QFN-3x3-16.

Features

- Regulated Output Current with $\pm 3\%$ Matching
- Drives up to 5 WLEDs at 20mA Each
- 16 Steps Brightness Control Using Pulse Signal Dimming
- Wide Operating Voltage Range: 2.8V to 5.5V
- High Operating Frequency: 1MHz
- Auto 1x/1.5x Charge Pump Mode Selection
- Built-in Soft-start
- Output Over Voltage Protection
- Built-in UVLO
- Built-in OTSD
- Operating Temperature Range: -40°C to $+85^{\circ}\text{C}$

Pin Assignments

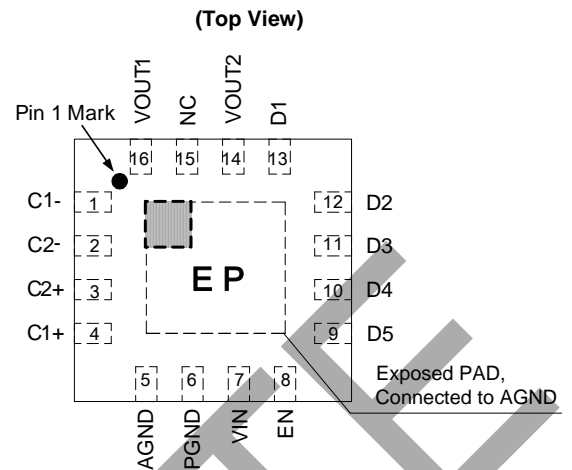

Note: Pin 14 should be connected with Pin 16 on PCB Board.

QFN-3x3-16

Applications

- Mobile Phone
- PDA
- MP3/4

OBSOLETE

Typical Applications Circuit

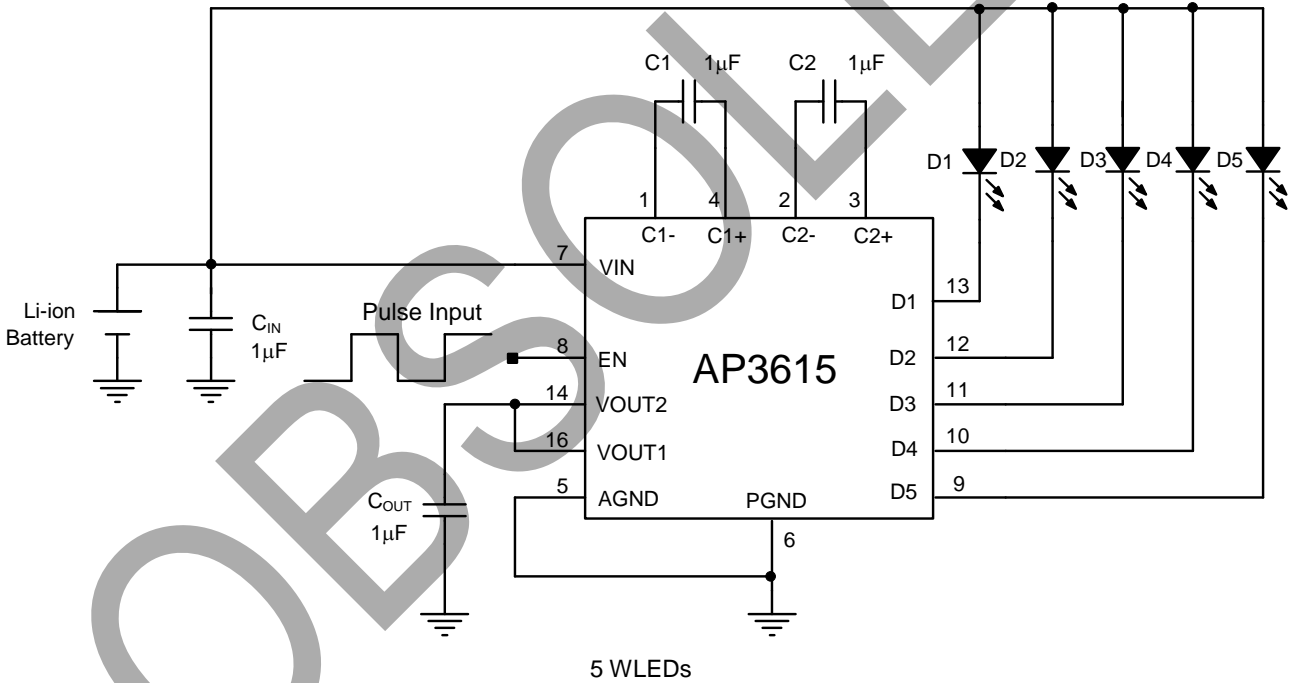
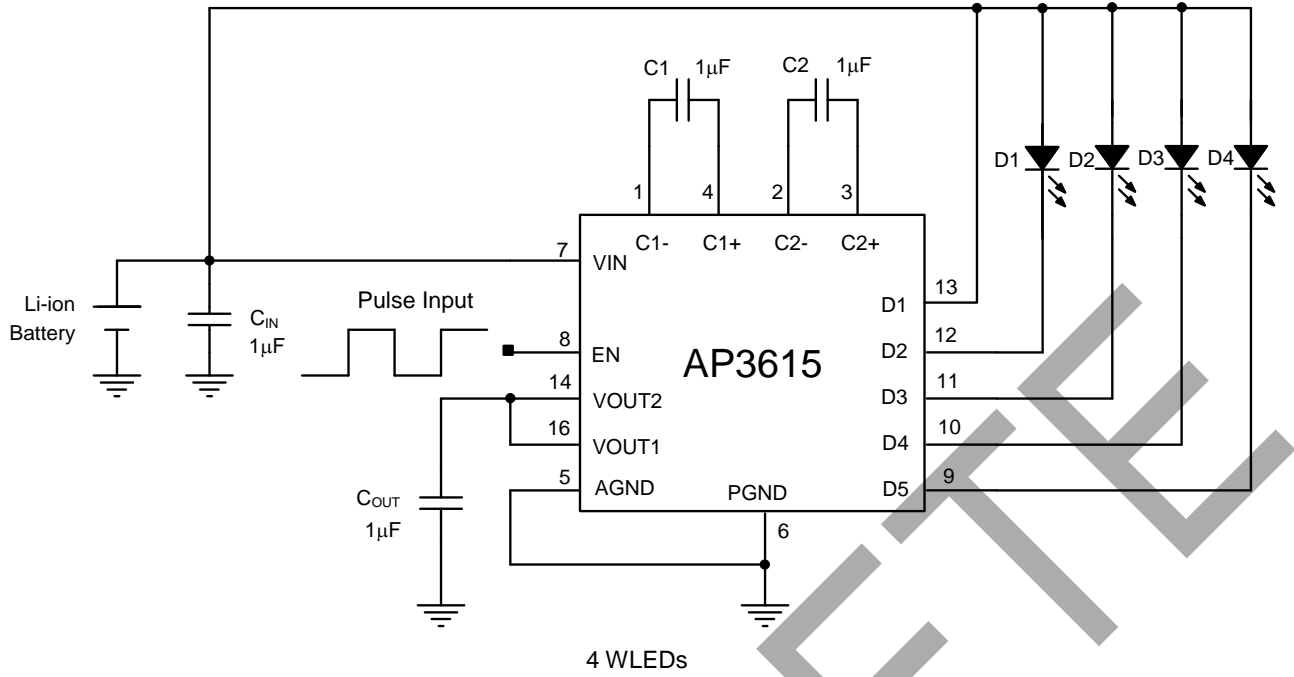

Detailed application information, please refer to AP3615 application note.

OBSOLETE - PART DISCONTINUED

OBSOLETE - PART DISCONTINUED

Pin Descriptions

Pin Number	Pin Name	Function
1	C1-	Flying capacitor 1 negative terminal. The flying capacitor should be connected as close to this pin as possible
2	C2-	Flying capacitor 2 negative terminal. The flying capacitor should be connected as close to this pin as possible
3	C2+	Flying capacitor 2 positive terminal. The flying capacitor should be connected as close to this pin as possible
4	C1+	Flying capacitor 1 positive terminal. The flying capacitor should be connected as close to this pin as possible
5	AGND	Analog ground
6	PGND	Power ground
7	VIN	Supply voltage input
8	EN	Enable control input. Logic high enables the IC; while logic low forces the IC into shutdown mode. It is used for digital dimming by applying a pulse signal on it.
9, 10, 11, 12, 13	D5 - D1	Current sink for WLED5, 4, 3, 2, 1. Connect the cathode of WLEDs to these pins. If not used, these pins must be connected with VIN
14	VOUT2	Output pin 2. It powers 5 channels current sink
15	NC	No connection
16	VOUT1	Output Pin 1. It's the charge pump output. The output capacitor should be placed closely to this pin

Functional Block Diagram

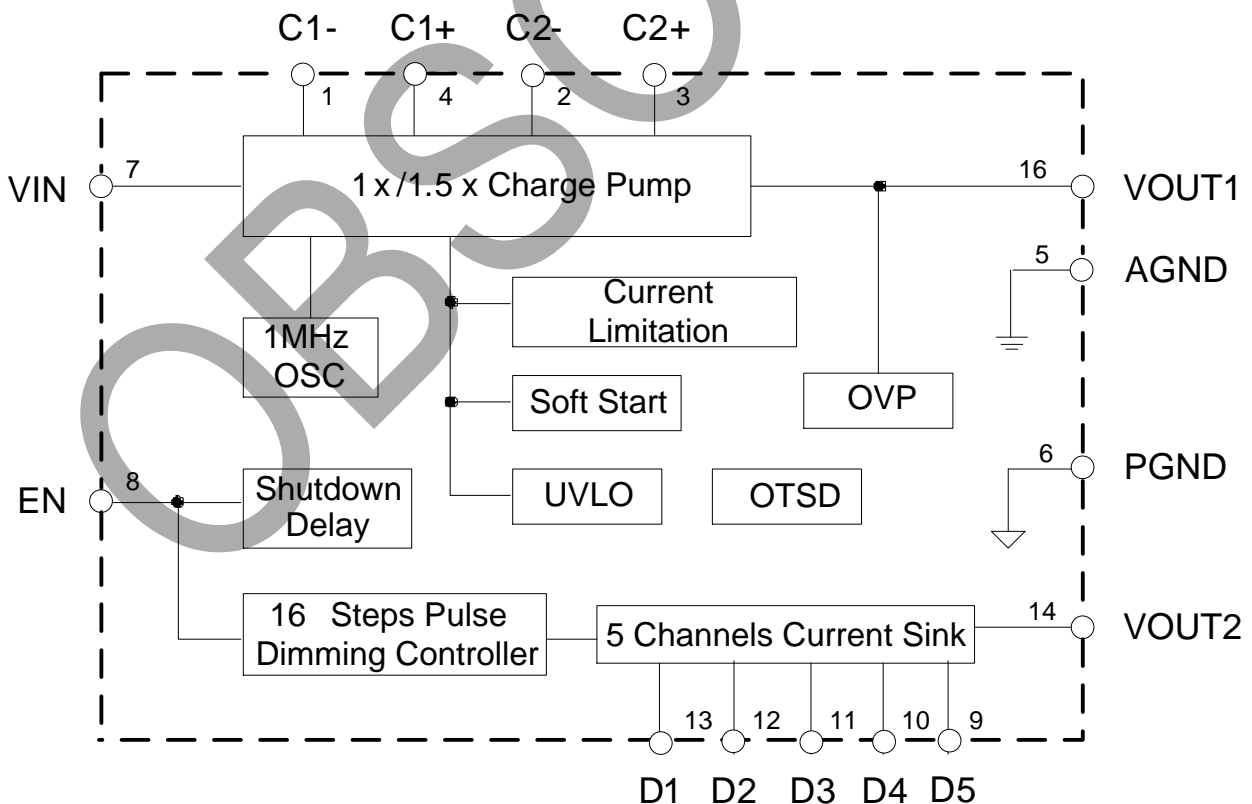

Absolute Maximum Ratings (Note 1)

Symbol	Parameter	Value	Unit
V_{IN}	Input Voltage	-0.3 to 6	V
V_{OUT}	VOUT Pin Voltage (VOUT1 & VOUT2)	-6 to 0.3	V
V_{EN}	EN Pin Voltage	-0.3 to 6	V
V_{C+}	C1+, C2+ Pin Voltage	-0.3 to 6	V
V_{C-}	C1-, C2- Pin Voltage	-6 to 0.3	V
V_D	D1, D2, D3, D4 and D5 Pin Voltage	V_{OUT} to V_{IN}	V
θ_{JA}	Thermal Resistance (Junction to Ambient, No Heat Sink, Free Air)	60	°C/W
T_J	Operating Junction Temperature	+150	°C
T_{STG}	Storage Temperature	-65 to +150	°C
T_{LEAD}	Lead Temperature (Soldering, 10sec)	+260	°C

Note 1: Stresses greater than those listed under "Absolute Maximum Ratings" may cause permanent damage to the device. These are stress ratings only, and functional operation of the device at these or any other conditions beyond those indicated under "Recommended Operating Conditions" is not implied. Exposure to "Absolute Maximum Ratings" for extended periods may affect device reliability.

Recommended Operating Conditions

Symbol	Parameter	Min	Max	Unit
V_{IN}	Input Voltage	2.8	5.5	V
T_A	Operating Ambient Temperature	-40	+85	°C

Electrical Characteristics ($V_{IN}=3.6V$, $V_{EN}=V_{IN}$, $T_A=+25^{\circ}C$, $C_{IN}=C_1=C_2=C_{OUT}=1\mu F$, V_F (forward voltage)=3.2V, unless otherwise noted.)

Symbol	Parameter	Conditions	Min	Typ	Max	Unit
Input Section						
V_{IN}	Input Voltage	$I_D=0mA$ to 100mA	2.8	–	5.5	V
–	Under Voltage Lockout Threshold	V_{IN} Falling	–	2.2	–	V
–	Under Voltage Lockout Hysteresis	–	–	250	–	mV
I_{CC}	Supply Current	No Load	–	1.7	3	mA
I_{SHDN}	Shutdown Supply Current	$V_{EN}=GND$	–	3	10	μA
Charge Pump Section						
f_{OSC}	Switch Frequency	$V_{IN}=3.0V$, 1.5x Mode	0.7	1	1.3	MHz
$V_{1.5X}$	1x Mode to 1.5x Mode Transition Voltage (V_{IN} Falling)	$V_D=3.2V$, $I_{D1}=I_{D2}=I_{D3}=I_{D4}=I_{D5}=20mA$	–	3.5	3.6	V
V_{1X}	1.5x Mode to 1x Mode Transition Voltage (V_{IN} Rising)	$V_D=3.2V$, $I_{D1}=I_{D2}=I_{D3}=I_{D4}=I_{D5}=20mA$	–	3.7	3.8	V
Current Source Section						
I_D	WLED Current	100% Setting, $3.0V \leq V_{IN} \leq 5.0V$ $T_A = -40^{\circ}C$ to $+85^{\circ}C$	18.5	20	21.5	mA
$I_{D-Match1}$	Current Matching Between any Two Outputs	$V_{D1}=V_{D2}=V_{D3}=V_{D4}=V_{D5}=3.2V$	-3	–	3	%
$I_{D-Match2}$	Current Matching Between any Two Outputs	$V_{D1}=V_{D2}=V_{D3}=V_{D4}=V_{D5}=3.0V$ to 4.0V $V_{IN}=3.2V$ to 5.0V	-3.5	–	3.5	%
Enable Section						
V_{IH}	EN High Level Threshold Voltage	–	1.5	–	–	V
V_{IL}	EN Low Level Threshold Voltage	–	–	–	0.5	V
I_{EN}	EN Input Current	$V_{EN}=0V$ to 5V	–	1	10	μA
t_{SHDN}	EN Low to Shutdown Delay	–	1	–	–	ms
t_{LO}	EN Low Time for Dimming	–	0.1	–	0.3	ms
t_{HI}	EN High Time for Dimming	–	0.1	–	–	ms
Total Device						
t_{SS}	Soft-start Time	$I_D=100mA$ Total	–	200	–	μs
I_{INRUSH}	Inrush Current	$V_{IN}=3.2V$, $I_D=100mA$ Total	–	320	–	mA
V_{OVP}	Over Voltage Protection	(Note 2)	–	5.5	–	V
T_{OTSD}	Thermal Shutdown	–	–	+160	–	$^{\circ}C$
T_{HYS}	Thermal Shutdown Hysteresis	–	–	+20	–	$^{\circ}C$
θ_{JC}	Thermal Resistance (Junction to Case)	QFN-3x3-16	–	15	–	$^{\circ}C/W$

Note 2: Open circuit at any WLED that is programmed to be in the on state.

OBSOLETE - PART DISCONTINUED

Performance Characteristics ($T_A=+25^\circ\text{C}$, $C_{IN}=C_1=C_2=C_{OUT}=1\mu\text{F}$, $V_F=3.2\text{V}$, unless otherwise noted.)

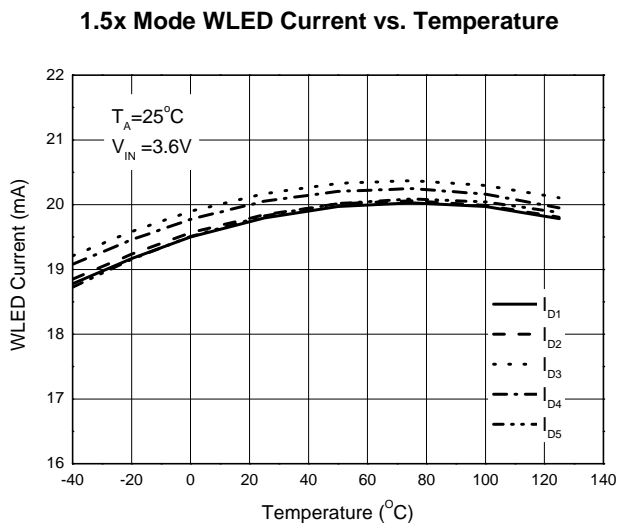
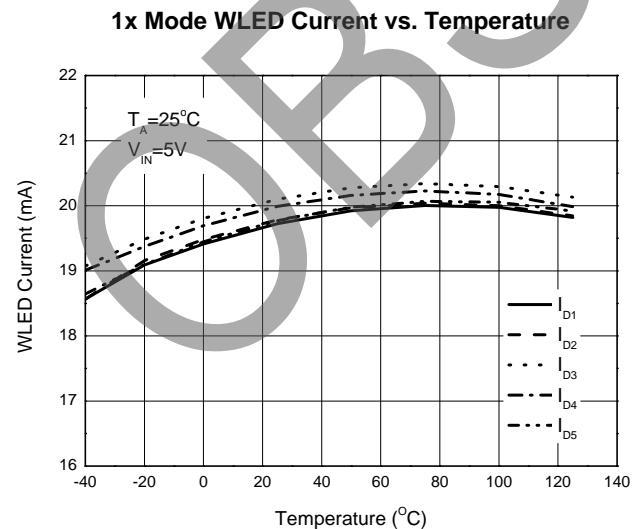
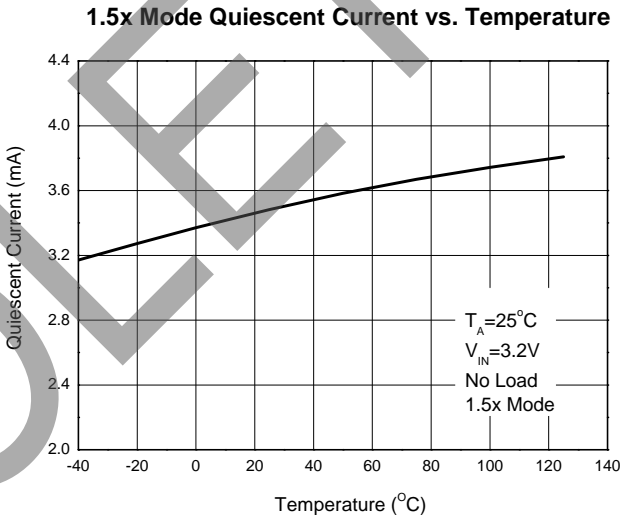
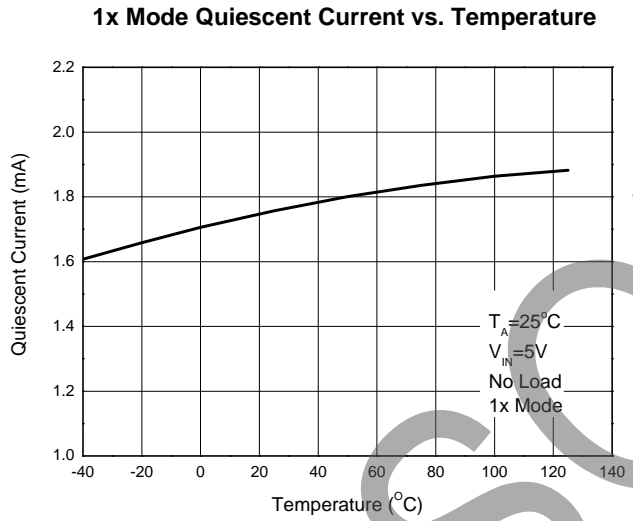
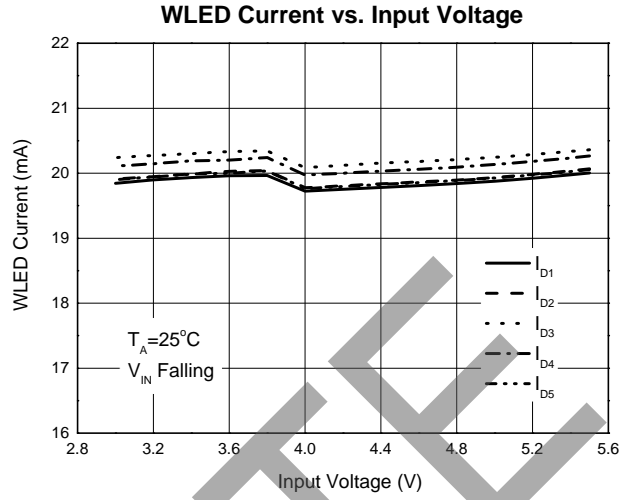
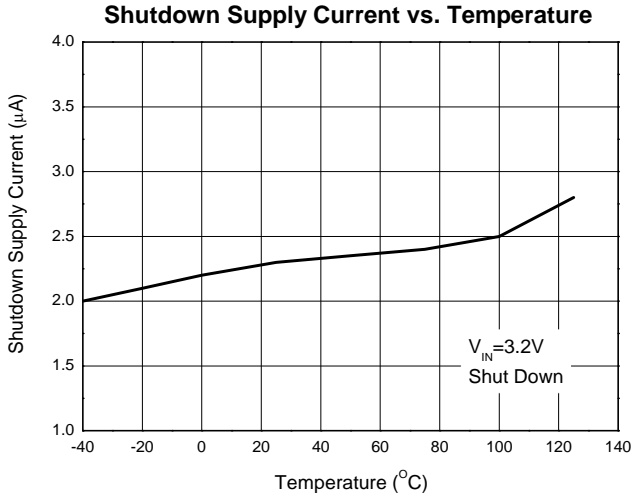

Performance Characteristics (Cont. $T_A=+25^\circ\text{C}$, $C_{IN}=C_1=C_2=C_{OUT}=1\mu\text{F}$, $V_F=3.2\text{V}$, unless otherwise noted.)

Efficiency vs. Input Voltage

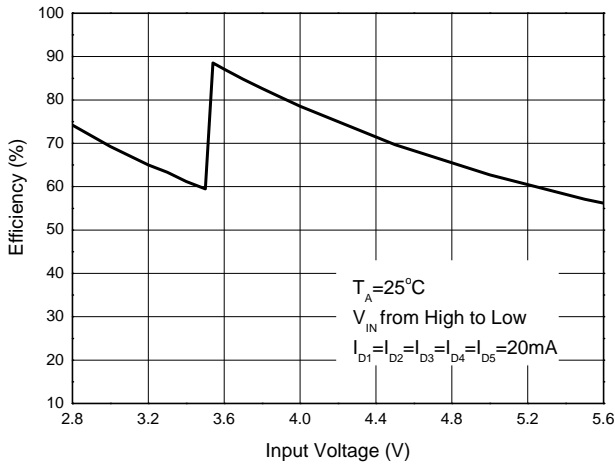

Frequency vs. Temperature

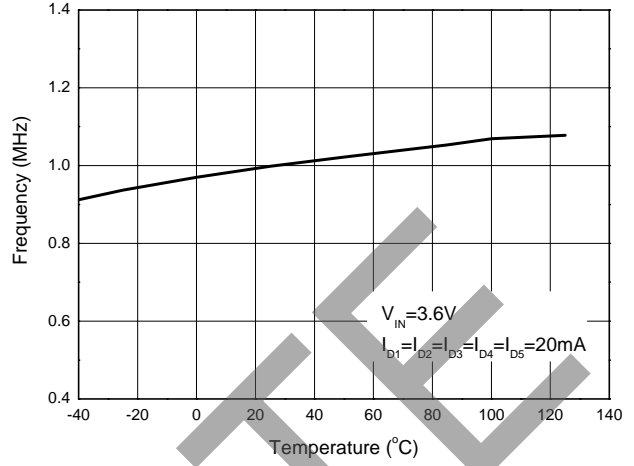

1x Mode Quiescent Current vs. Input Voltage

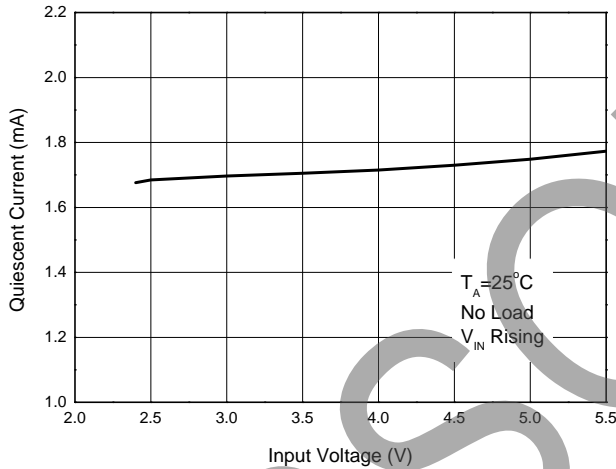

FUVLO Threshold Voltage vs. Temperature

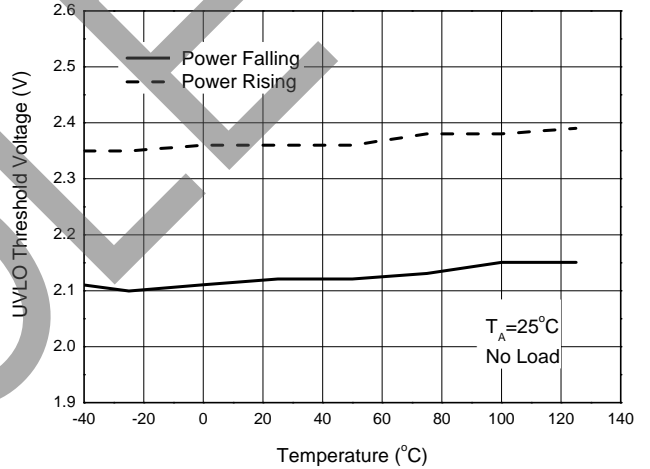

1x Mode Turn on Characteristic

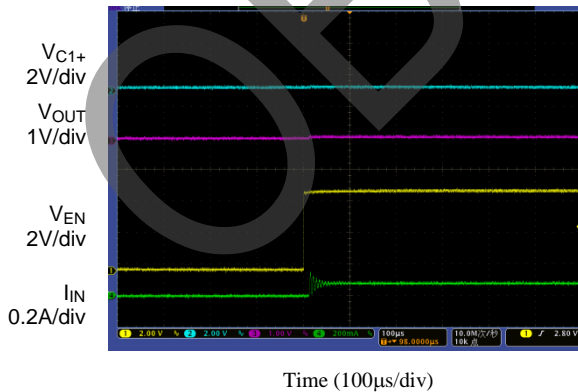

1x Mode Turn off Characteristic

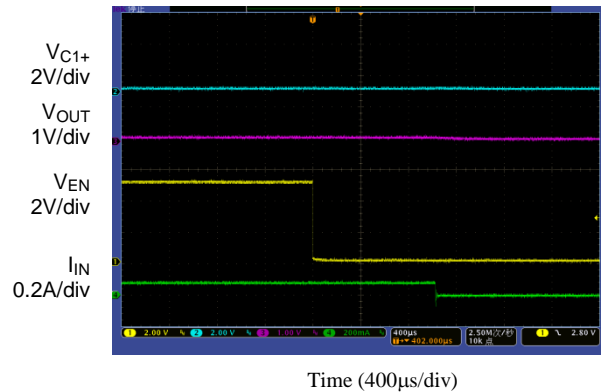

OBSOLETE - PART DISCONTINUED

Performance Characteristics (Cont. $T_A=+25^{\circ}\text{C}$, $C_{IN}=C_1=C_2=C_{OUT}=1\mu\text{F}$, $V_F=3.2\text{V}$, unless otherwise noted.)

1.5x Mode Turn on Characteristic

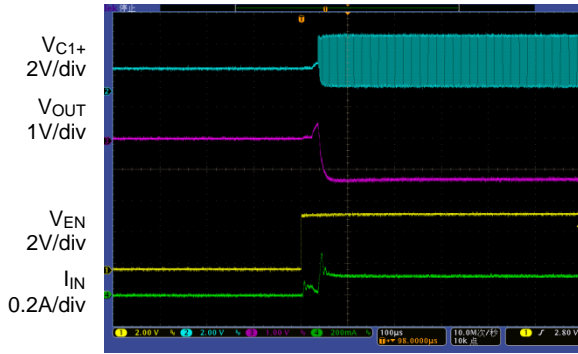

Time (100µs/div)

1.5x Mode Turn off Characteristic

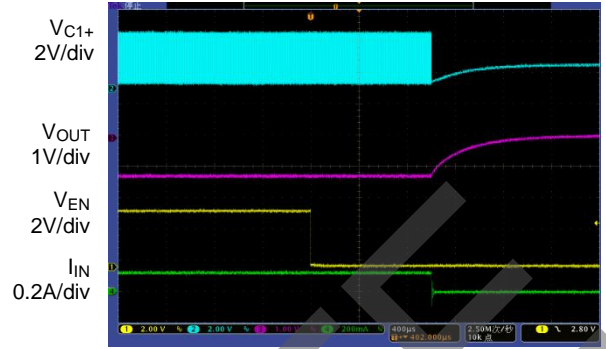

Time (400µs/div)

1x Mode Dimming Operation ($V_{IN}=5\text{V}$, $f_{EN}=2\text{kHz}$)

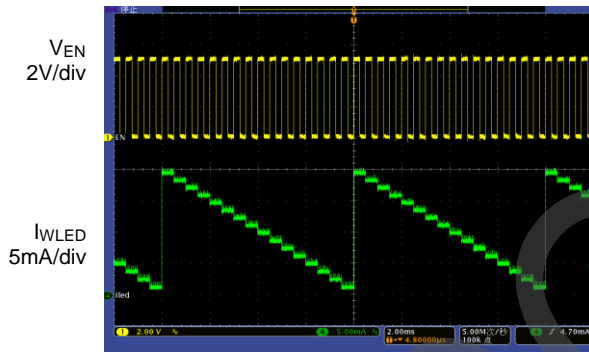

Time (2ms/div)

Output Ripple ($V_{IN}=3.3\text{V}$, $I_D=100\text{mA}$)

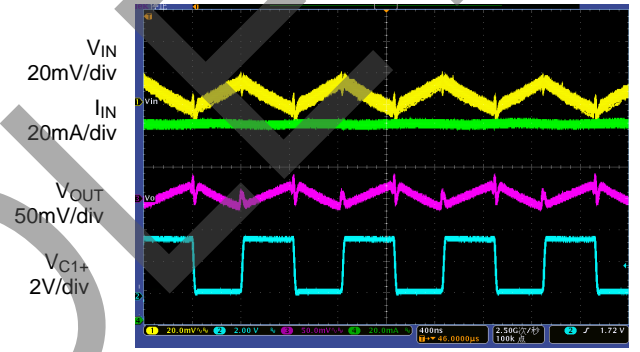

Time (400ns/div)

OBSOLETE - PART DISCONTINUED

OBSOLETE

OBSOLETE - PART DISCONTINUED

Digital Dimming Operating Diagram (Note 3)

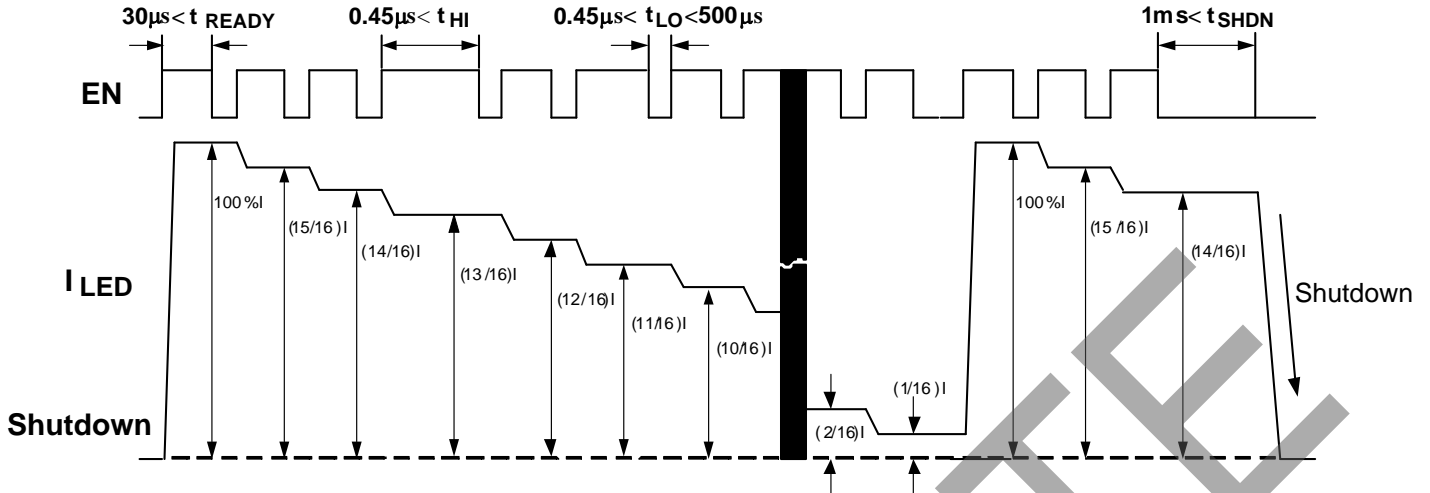

Digital Dimming Operating Diagram of AP3615

Note: 3. The dimming control can be achieved by applying a pulse to the EN pin. When the low level duration time of pulse is between t_{LOmin} and t_{LOmax} , and the high level duration time is larger than t_{HImin} , the LED current will decrease 1/16. If the low level duration time is larger than $t_{SHDNmax}$, the IC will be turned off. When AP3615 is powered on, the WLED is in full brightness. And it will keep maximum current until the pulse is detected. After 15 pulses the WLED current decreases to 1/16 of full brightness. It will increase to full brightness if a pulse is added to EN pin then.

Ordering Information

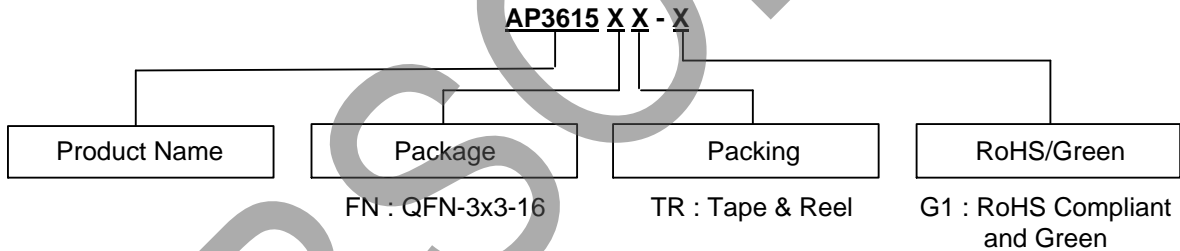

Package	Temperature Range	Part Number	Marking ID	Packing
QFN-3x3-16	-40 to +85°C	AP3615FNTR-G1	B2B	Tape & Reel

Package Outline Dimensions (All dimensions in mm(inch).)

(1) Package Type: QFN-3x3-16

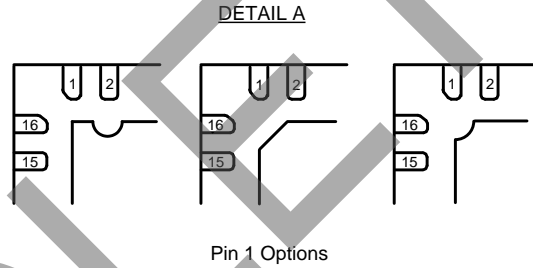
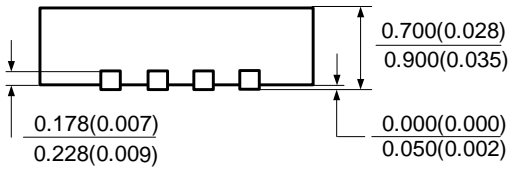
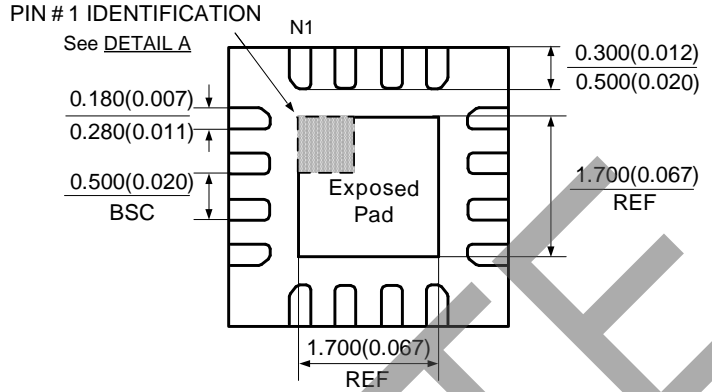
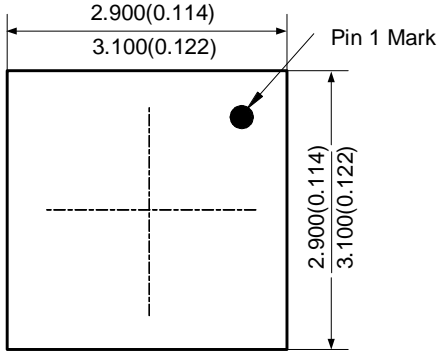

OBSOLETE - PART DISCONTINUED

OBSOLETE

IMPORTANT NOTICE

DIODES INCORPORATED MAKES NO WARRANTY OF ANY KIND, EXPRESS OR IMPLIED, WITH REGARDS TO THIS DOCUMENT, INCLUDING, BUT NOT LIMITED TO, THE IMPLIED WARRANTIES OF MERCHANTABILITY AND FITNESS FOR A PARTICULAR PURPOSE (AND THEIR EQUIVALENTS UNDER THE LAWS OF ANY JURISDICTION).

Diodes Incorporated and its subsidiaries reserve the right to make modifications, enhancements, improvements, corrections or other changes without further notice to this document and any product described herein. Diodes Incorporated does not assume any liability arising out of the application or use of this document or any product described herein; neither does Diodes Incorporated convey any license under its patent or trademark rights, nor the rights of others. Any Customer or user of this document or products described herein in such applications shall assume all risks of such use and will agree to hold Diodes Incorporated and all the companies whose products are represented on Diodes Incorporated website, harmless against all damages.

Diodes Incorporated does not warrant or accept any liability whatsoever in respect of any products purchased through unauthorized sales channel. Should Customers purchase or use Diodes Incorporated products for any unintended or unauthorized application, Customers shall indemnify and hold Diodes Incorporated and its representatives harmless against all claims, damages, expenses, and attorney fees arising out of, directly or indirectly, any claim of personal injury or death associated with such unintended or unauthorized application.

Products described herein may be covered by one or more United States, international or foreign patents pending. Product names and markings noted herein may also be covered by one or more United States, international or foreign trademarks.

This document is written in English but may be translated into multiple languages for reference. Only the English version of this document is the final and determinative format released by Diodes Incorporated.

LIFE SUPPORT

Diodes Incorporated products are specifically not authorized for use as critical components in life support devices or systems without the express written approval of the Chief Executive Officer of Diodes Incorporated. As used herein:

A. Life support devices or systems are devices or systems which:

1. are intended to implant into the body, or
2. support or sustain life and whose failure to perform when properly used in accordance with instructions for use provided in the labeling can be reasonably expected to result in significant injury to the user.

B. A critical component is any component in a life support device or system whose failure to perform can be reasonably expected to cause the failure of the life support device or to affect its safety or effectiveness.

Customers represent that they have all necessary expertise in the safety and regulatory ramifications of their life support devices or systems, and acknowledge and agree that they are solely responsible for all legal, regulatory and safety-related requirements concerning their products and any use of Diodes Incorporated products in such safety-critical, life support devices or systems, notwithstanding any devices- or systems-related information or support that may be provided by Diodes Incorporated. Further, Customers must fully indemnify Diodes Incorporated and its representatives against any damages arising out of the use of Diodes Incorporated products in such safety-critical, life support devices or systems.

Copyright © 2019, Diodes Incorporated

www.diodes.com

Looking for pricing, stock, or lifecycle information?

Click below to explore more details on WIN SOURCE:

 [View AP3615FNTR-G1 on WIN SOURCE](#)

 [Diodes Incorporated](#) Information

Optimize Your Supply Chain with WIN SOURCE Solutions

-  Global Sourcing Solution
-  Obsolete Management
-  Cost Control Management
-  Shortage Management
-  Alternative Solution
-  Excess Inventory Management