



**THE DATASHEET OF
AP3606FNTR**



General Description

The AP3606 and AP3607 are step-up DC-DC converters based on 1x/1.5x charge pump and low dropout current sink, which helps them maintain the highest efficiency. The AP3606 is specially designed to drive up to 4 WLEDs in backlight display while the AP3607 is designed for 6 WLEDs.

These devices provide up to 20mA current for each WLED. There are totally 16 steps of current control, which is achieved through a digital pulse dimming function on EN pin. Additionally, 1MHz high switching frequency enables the use of small external capacitors. Internal soft-start circuitry prevents excessive inrush current during start-up and mode transition.

The supply voltage ranges of AP3606 and AP3607 are from 2.7V to 5.5V which make them ideally suit for applications powered by Li-ion battery.

These ICs are available in the tiny package of QFN-3x3-16.

Features

- Regulated Output Current with $\pm 3\%$ Matching
- Drives up to 4 WLEDs at 20mA Each (AP3606)
Drives up to 6 WLEDs at 20mA Each (AP3607)
- 16 Steps Brightness Control Using Pulse Signal Dimming
- Wide Operating Voltage Range: 2.7V to 5.5V
- High Operating Frequency: 1MHz
- Auto 1x/1.5x Charge Pump Mode Selection
- Built-in Soft-start
- Output Over Voltage Protection
- Built-in UVLO
- Built-in OTSD
- Operating Temperature Range: -40°C to 85°C

Applications

- Mobile Phone
- PDA
- MP3/4

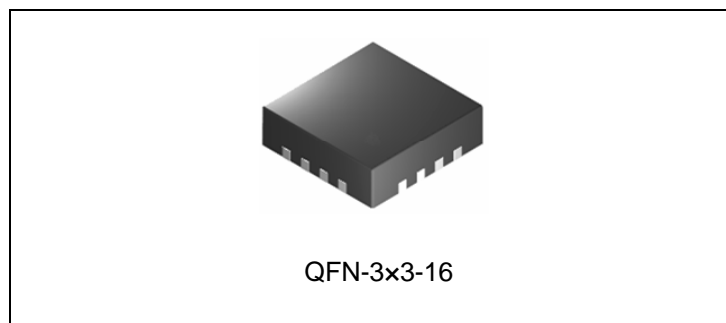
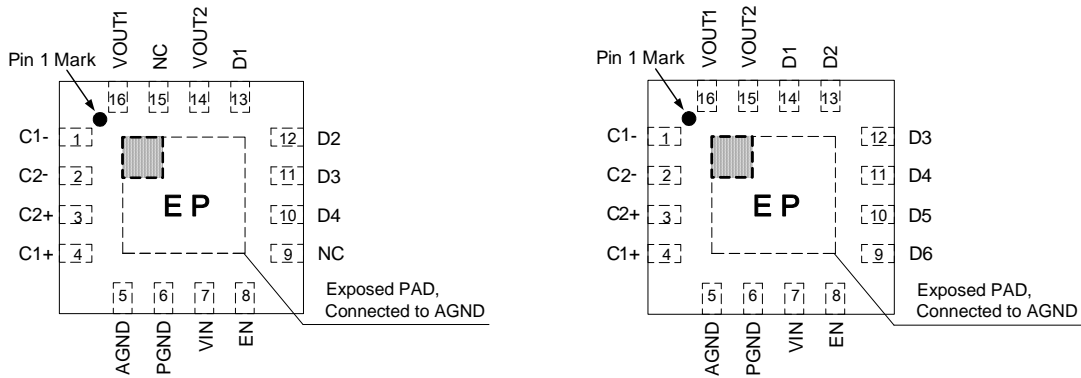

Figure 1. Package Type of AP3606/AP3607

Pin Configuration

FN Package
(QFN-3×3-16)



Note: Pin 14 should be connected with Pin 16 on PCB Board.

Note: Pin 15 should be connected with Pin 16 on PCB Board.

AP3606

AP3607

Figure 2. Pin Configuration of AP3606/AP3607 (Top View)

Pin Description

Pin Number		Pin Name	Function
AP3606	AP3607		
1	1	C1-	Flying capacitor 1 negative terminal. The flying capacitor should be connected as close to this pin as possible
2	2	C2-	Flying capacitor 2 negative terminal. The flying capacitor should be connected as close to this pin as possible
3	3	C2+	Flying capacitor 2 positive terminal. The flying capacitor should be connected as close to this pin as possible
4	4	C1+	Flying capacitor 1 positive terminal. The flying capacitor should be connected as close to this pin as possible
5	5	AGND	Analog ground
6	6	PGND	Power ground
7	7	VIN	Supply voltage input
8	8	EN	Enable control input. Logic high enables the IC; while logic low forces the IC into shutdown mode. It is used for digital dimming by applying a pulse signal on it.
9, 15		NC	No connection (AP3606 only)
	9, 10	D6, D5	Current sink for WLED6 and WLED5. Connect the cathode of WLEDs to these pins. If not used, these pins must be connected with VIN (AP3607 only)
10, 11, 12, 13	11, 12, 13, 14	D4 ~ D1	Current sink for WLED4, 3, 2, 1. Connect the cathode of WLEDs to these pins. If not used, these pins must be connected with VIN
14	15	VOUT2	Output pin 2. It powers 4 channels current sink (AP3606) and 6 channels current sink (AP3607)
16	16	VOUT1	Output Pin 1. It's the charge pump output. The output capacitor should be placed closely to this pin

Functional Block Diagram

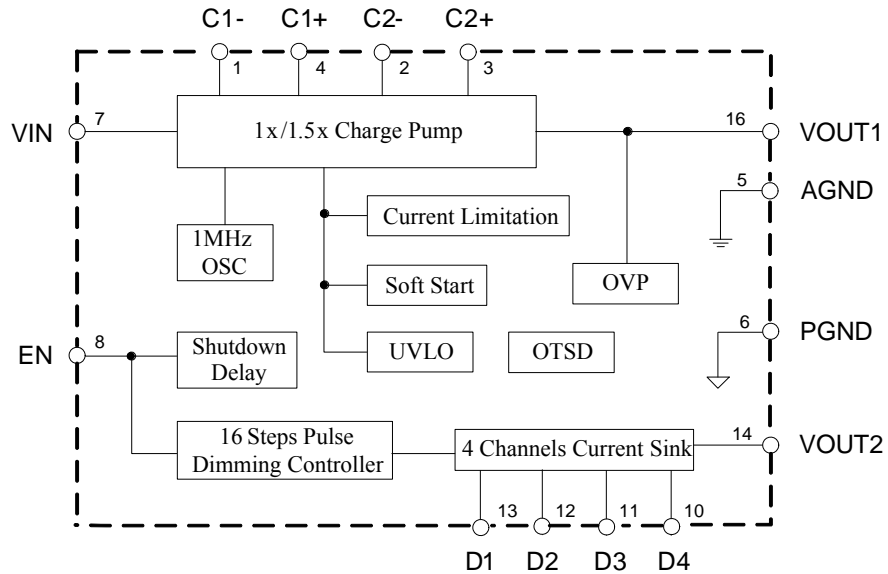

AP3606

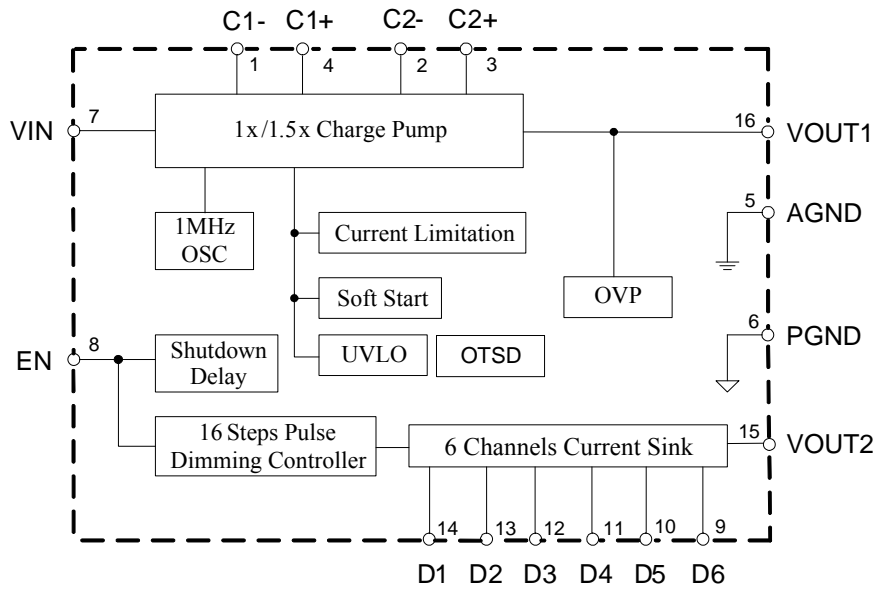

AP3607

Figure 3. Functional Block Diagram of AP3606/AP3607

Ordering Information

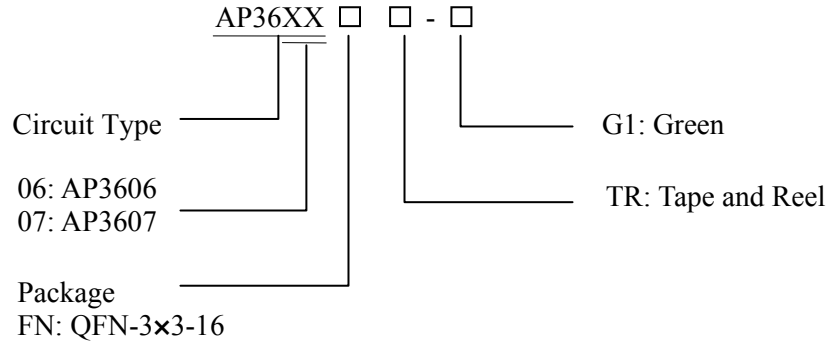

Package	Temperature Range	Part Number	Marking ID	Packing Type
QFN-3x3-16	-40 to 85°C	AP3606FNTR-G1	B1B	Tape & Reel
		AP3607FNTR-G1	B1C	

BCD Semiconductor's Pb-free products, as designated with "G1" suffix in the part number, are RoHS compliant and green.

Absolute Maximum Ratings (Note 1)

Parameter	Symbol	Value	Unit
Input Voltage	V_{IN}	-0.3 to 6	V
VOUT Pin Voltage (VOUT1 & VOUT2)	V_{OUT}	-6 to 0.3	V
EN Pin Voltage	V_{EN}	-0.3 to 6	V
C1+, C2+ Pin Voltage	V_{C+}	-0.3 to 6	V
C1-, C2- Pin Voltage	V_{C-}	-6 to 0.3	V
D1, D2, D3, D4 Pin Voltage	V_D	V_{OUT} to V_{IN}	V
D1, D2, D3, D4, D5, D6 Pin Voltage			
Thermal Resistance (Junction to Ambient, No Heat Sink, Free Air)	θ_{JA}	60	°C/W
Operating Junction Temperature	T_J	150	°C
Storage Temperature	T_{STG}	-65 to 150	°C
Lead Temperature (Soldering, 10sec)	T_{LEAD}	260	°C

Note 1: Stresses greater than those listed under “Absolute Maximum Ratings” may cause permanent damage to the device. These are stress ratings only, and functional operation of the device at these or any other conditions beyond those indicated under “Recommended Operating Conditions” is not implied. Exposure to “Absolute Maximum Ratings” for extended periods may affect device reliability.



Recommended Operating Conditions

Parameter	Symbol	Min	Max	Unit
Input Voltage	V_{IN}	2.7	5.5	V
Operating Ambient Temperature	T_A	-40	85	°C

Electrical Characteristics

$V_{IN}=3.6V$, $V_{EN}=V_{IN}$, $T_A=25^\circ C$, $C_{IN}=C1=C2=C_{OUT}=1\mu F$, V_F (forward voltage)=3.2V, unless otherwise noted.

Parameter	Symbol	Conditions	Min	Typ	Max	Unit	
Input Section							
Input Voltage	V_{IN}	$I_D=0mA$ to 80mA	2.7		5.5	V	
Under Voltage Lockout Threshold		V_{IN} Falling		2.2		V	
Under Voltage Lockout Hysteresis				250		mV	
Supply Current	I_{CC}	No Load		1.7	3	mA	
Shutdown Supply Current	I_{SHDN}	$V_{EN}=GND$		3	10	μA	
Charge Pump Section							
Switch Frequency	f_{OSC}	$V_{IN}=3.0V$, 1.5x Mode	0.7	1	1.3	MHz	
1x Mode to 1.5x Mode Transition Voltage (V_{IN} Falling)	$V_{1.5X}$	AP3606	$V_D=3.2V$, $I_{D1}=I_{D2}=I_{D3}=I_{D4}=20mA$		3.5	3.6	V
		AP3607	$V_D=3.2V$, $I_{D1}=I_{D2}=I_{D3}=I_{D4}=$ $I_{D5}=I_{D6}=20mA$				
1.5x Mode to 1x Mode Transition Voltage (V_{IN} Rising)	V_{1X}	AP3606	$V_D=3.2V$, $I_{D1}=I_{D2}=I_{D3}=I_{D4}=20mA$		3.7	3.8	V
		AP3607	$V_D=3.2V$, $I_{D1}=I_{D2}=I_{D3}=I_{D4}=$ $I_{D5}=I_{D6}=20mA$				
Current Source Section							
WLED Current	I_D	100% Setting, $3.0V \leq V_{IN} \leq 5.0V$ $T_A=-40^\circ C$ to $85^\circ C$	18.5	20	21.5	mA	



Electrical Characteristics (Continued)

$V_{IN}=3.6V$, $V_{EN}=V_{IN}$, $T_A=25^{\circ}C$, $C_{IN}=C1=C2=C_{OUT}=1\mu F$, V_F (forward voltage)=3.2V, unless otherwise noted.

Parameter	Symbol	Conditions		Min	Typ	Max	Unit
Current Matching Between any Two Outputs	$I_{D-Match1}$	AP3606	$V_{D1}=V_{D2}=V_{D3}=V_{D4}=3.2V$	-3		3	%
		AP3607	$V_{D1}=V_{D2}=V_{D3}=V_{D4}=V_{D5}=V_{D6}=3.2V$				
Current Matching Between any Two Outputs	$I_{D-Match2}$	AP3606	$V_{D1}=V_{D2}=V_{D3}=V_{D4}=3.0V$ to 4.0V $V_{IN}=3.2V$ to 5.0V	-3.5		3.5	%
		AP3607	$V_{D1}=V_{D2}=V_{D3}=V_{D4}=V_{D5}=V_{D6}=3.0V$ to 4.0V $V_{IN}=3.2V$ to 5.0V				
Enable Section							
EN High Level Threshold Voltage	V_{IH}			1.5			V
EN Low Level Threshold Voltage	V_{IL}					0.5	V
EN Input Current	I_{EN}	$V_{EN}=0V$ to 5V			1	10	μA
EN Low to Shutdown Delay	t_{SHDN}					1	ms
EN Low Time for Dimming	t_{LO}			0.45		500	μs
EN High Time for Dimming	t_{HI}			0.45			μs
Total Device							
Soft-start Time	t_{SS}	AP3606	$I_D=80mA$ Total		200		μs
		AP3607	$I_D=120mA$ Total				
Inrush Current	I_{INRUSH}	AP3606	$V_{IN}=3.2V$, $I_D=80mA$ Total		200		mA
		AP3607	$V_{IN}=3.2V$, $I_D=120mA$ Total		320		
Over Voltage Protection	V_{OVP}	Note 2			5.5		V
Thermal Shutdown	T_{OTSD}				160		$^{\circ}C$
Thermal Shutdown Hysteresis	T_{HYS}				20		$^{\circ}C$
Thermal Resistance (Junction to Case)	θ_{JC}	QFN-3x3-16			15		$^{\circ}C/W$

Note 2: Open circuit at any WLED that is programmed to be in the on state.

Typical Performance Characteristics

$T_A=25^\circ\text{C}$, $C_{IN}=C_1=C_2=C_{OUT}=1\mu\text{F}$, $V_F=3.2\text{V}$, unless otherwise noted.

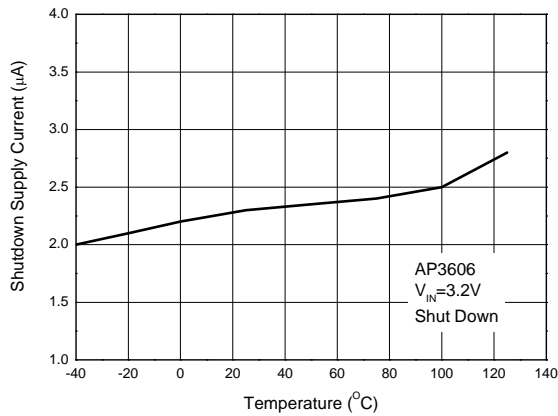

Figure 4. Shutdown Supply Current vs. Temperature

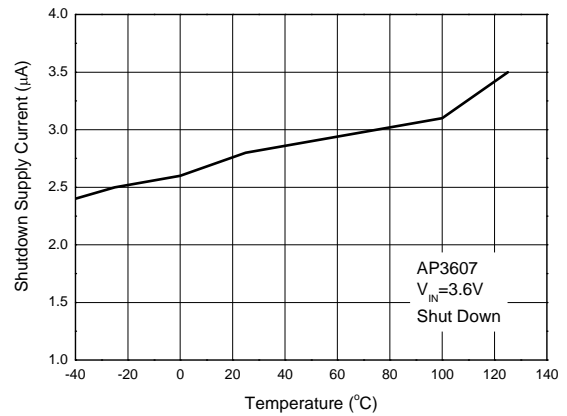

Figure 5. Shutdown Supply Current vs. Temperature

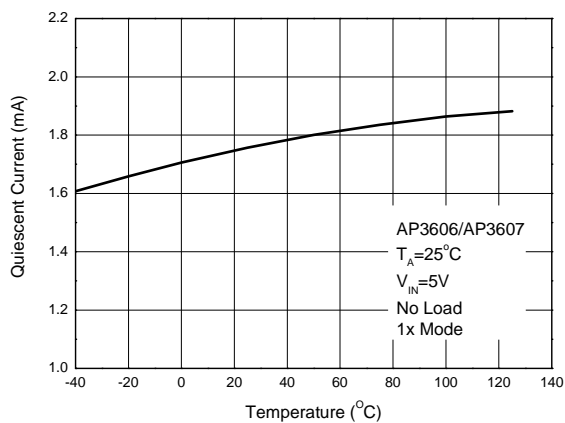

Figure 6. 1x Mode Quiescent Current vs. Temperature

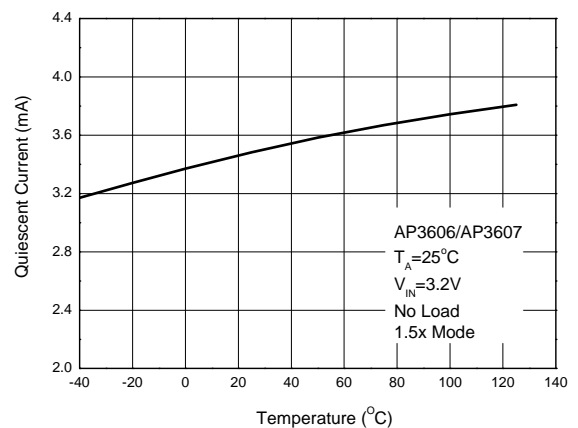

Figure 7. 1.5x Mode Quiescent Current vs. Temperature

Typical Performance Characteristics (Continued)

$T_A=25^\circ\text{C}$, $C_{IN}=C_1=C_2=C_{OUT}=1\mu\text{F}$, $V_F=3.2\text{V}$, unless otherwise noted.

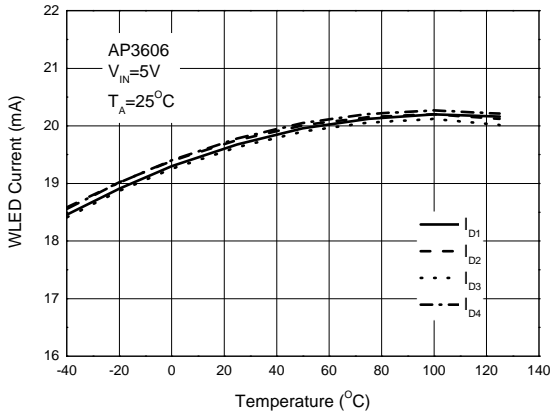

Figure 8. 1x Mode WLED Current vs. Temperature

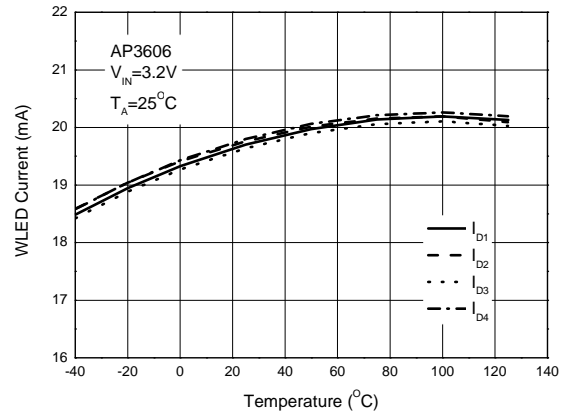

Figure 9. 1.5x Mode WLED Current vs. Temperature

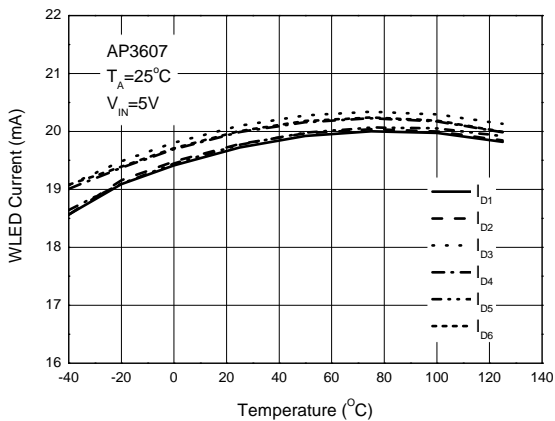

Figure 10. 1x Mode WLED Current vs. Temperature

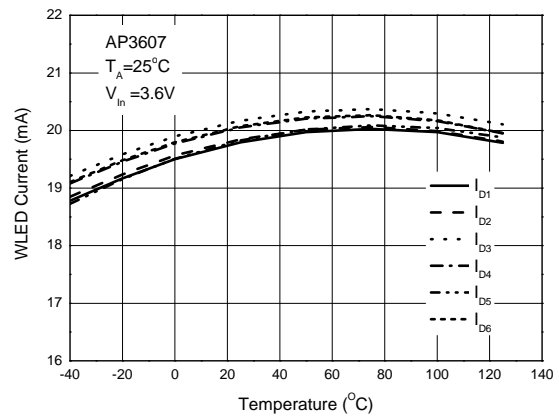

Figure 11. 1.5x Mode WLED Current vs. Temperature

Typical Performance Characteristics (Continued)

$T_A=25^\circ\text{C}$, $C_{IN}=C_1=C_2=C_{OUT}=1\mu\text{F}$, $V_F=3.2\text{V}$, unless otherwise noted.

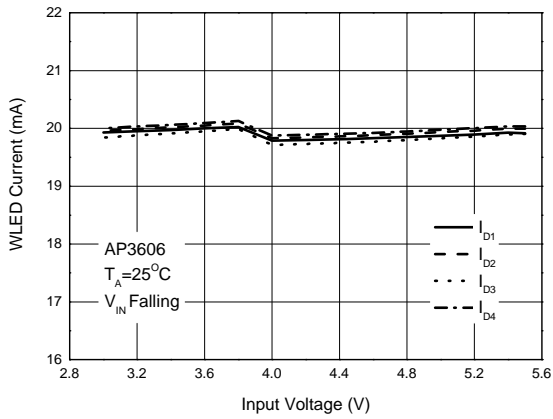

Figure 12. WLED Current vs. Input Voltage

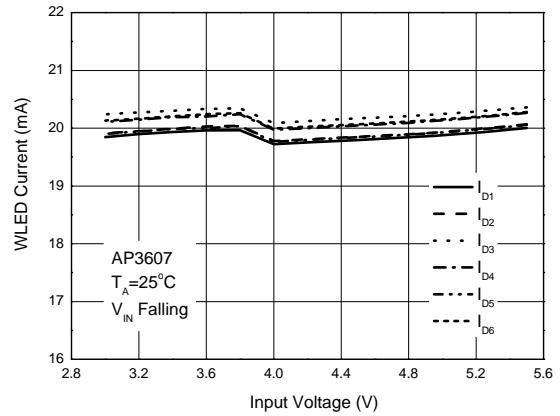

Figure 13. WLED Current vs. Input Voltage

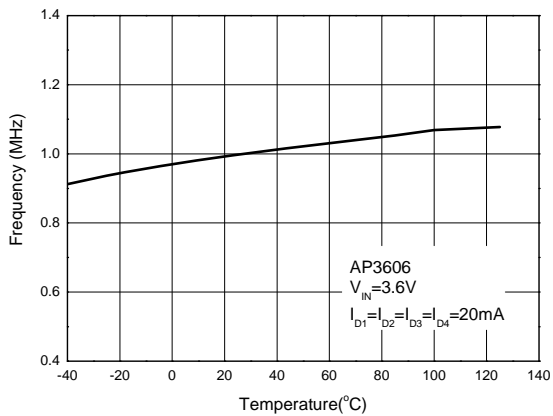

Figure 14. Frequency vs. Temperature

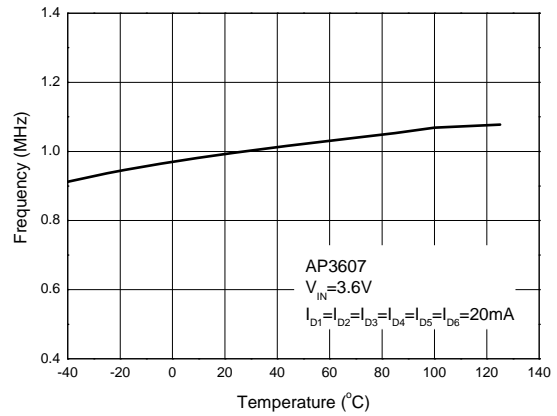

Figure 15. Frequency vs. Temperature

Typical Performance Characteristics (Continued)

$T_A=25^\circ\text{C}$, $C_{IN}=C_1=C_2=C_{OUT}=1\mu\text{F}$, $V_F=3.2\text{V}$, unless otherwise noted.

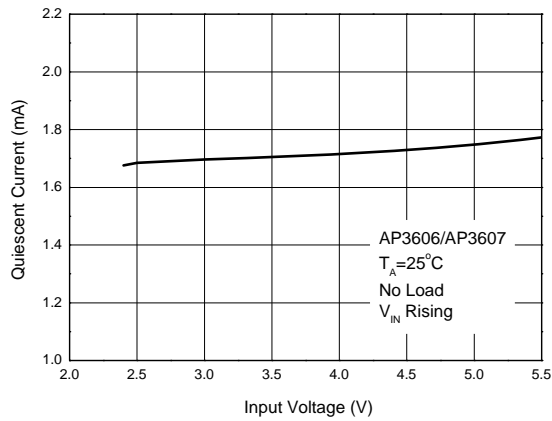

Figure 16. 1x Mode Quiescent Current vs. Input Voltage

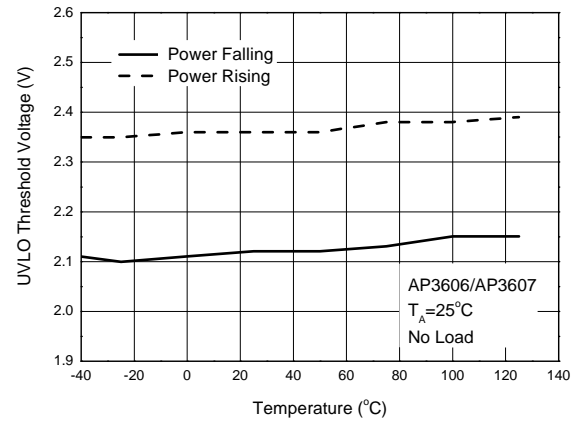

Figure 17. UVLO Threshold Voltage vs. Temperature

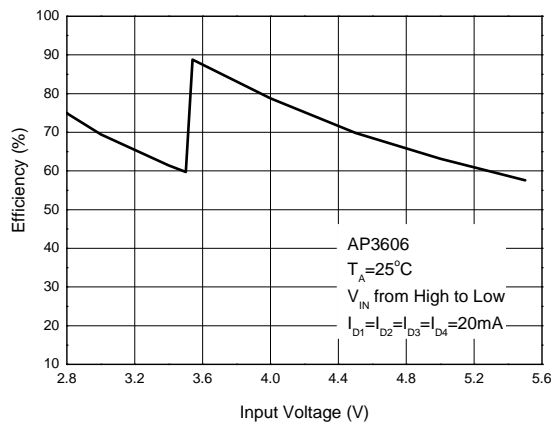

Figure 18. Efficiency vs. Input Voltage

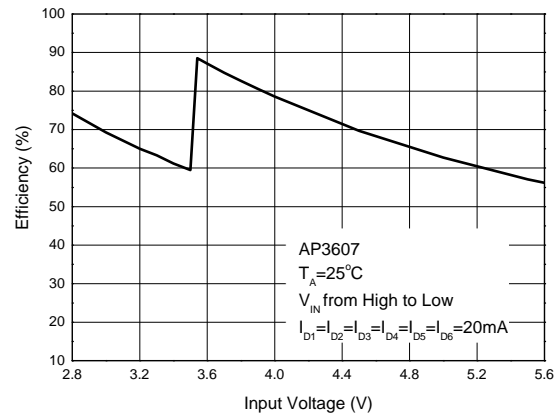

Figure 19. Efficiency vs. Input Voltage

Typical Performance Characteristics (Continued)

$T_A=25^{\circ}\text{C}$, $C_{IN}=C_1=C_2=C_{OUT}=1\mu\text{F}$, $V_F=3.2\text{V}$, unless otherwise noted.



Time (100µs/div)

Figure 20. 1x Mode Turn on Characteristic (AP3606)



Time (400µs/div)

Figure 21. 1x Mode Turn off Characteristic (AP3606)



Time (100µs/div)

Figure 22. 1x Mode Turn on Characteristic (AP3607)

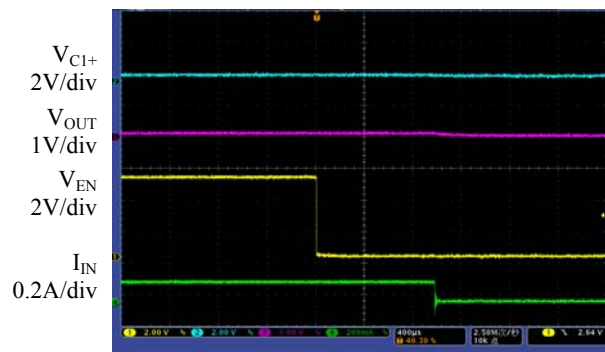

Time (400µs/div)

Figure 23. 1x Mode Turn off Characteristic (AP3607)

Typical Performance Characteristics (Continued)

$T_A=25^\circ\text{C}$, $C_{IN}=C_1=C_2=C_{OUT}=1\mu\text{F}$, $V_F=3.2\text{V}$, unless otherwise noted.

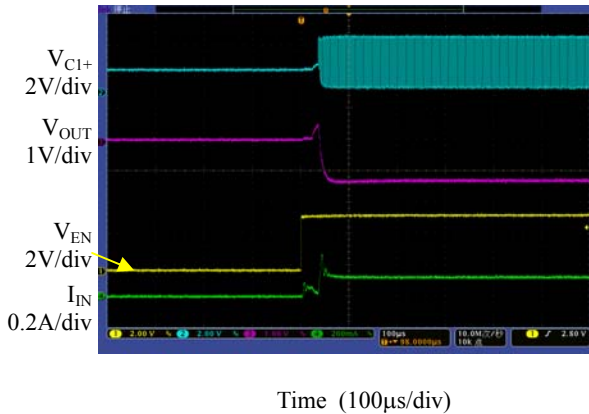

Figure 24. 1.5x Mode Turn on Characteristic (AP3606)

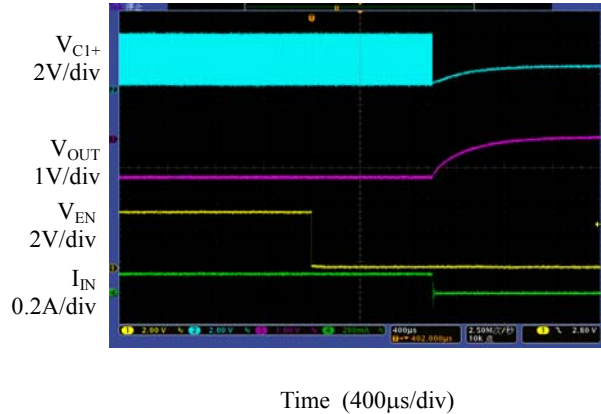

Figure 25. 1.5x Mode Turn off Characteristic (AP3606)

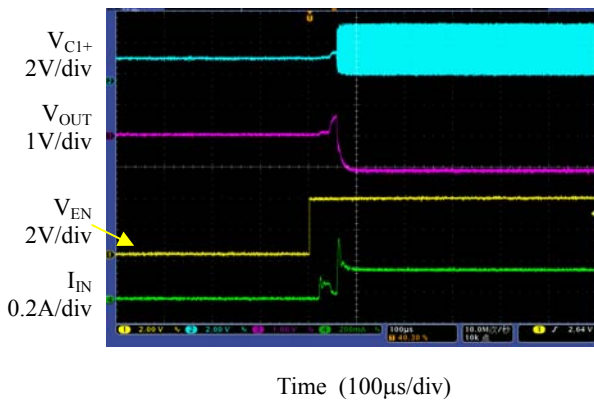

Figure 26. 1.5x Mode Turn on Characteristic (AP3607)

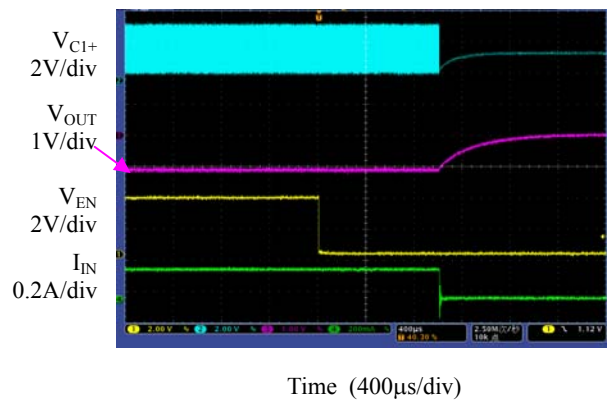

Figure 27. 1.5x Mode Turn off Characteristic (AP3607)

Typical Performance Characteristics (Continued)

$T_A=25^{\circ}\text{C}$, $C_{IN}=C_1=C_2=C_{OUT}=1\mu\text{F}$, $V_F=3.2\text{V}$, unless otherwise noted.

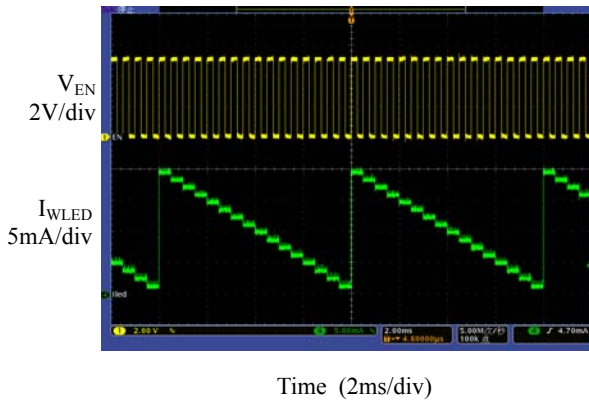

Figure 28. 1x Mode Dimming Operation (AP3606, $V_{IN}=5\text{V}$, $f_{EN}=2\text{kHz}$)

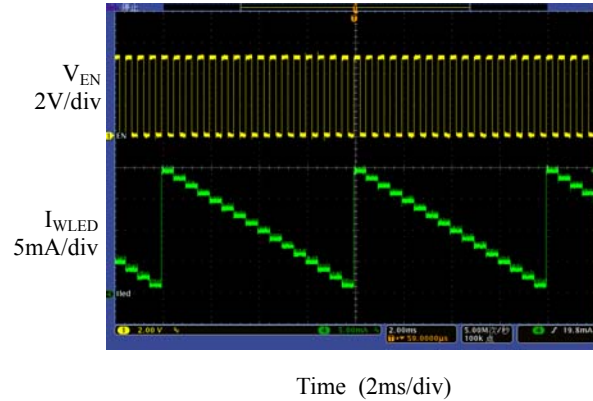

Figure 29. 1x Mode Dimming Operation (AP3607, $V_{IN}=5\text{V}$, $f_{EN}=2\text{kHz}$)

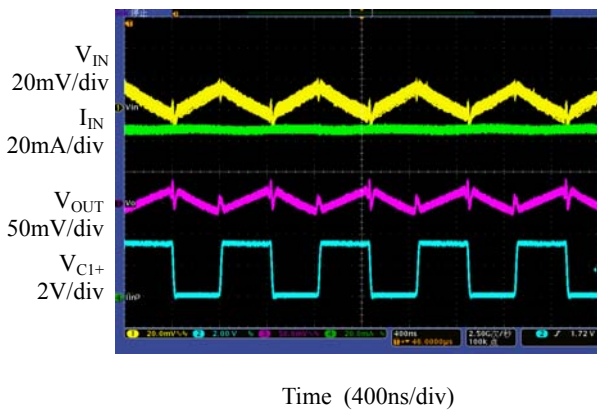

Figure 30. Output Ripple (AP3606, $V_{IN}=3.3\text{V}$, $I_D=80\text{mA}$)

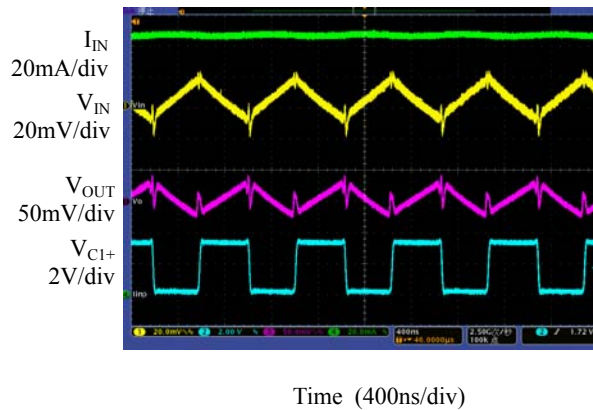

Figure 31. Output Ripple (AP3607, $V_{IN}=3.3\text{V}$, $I_D=120\text{mA}$)

Digital Dimming Operating Diagram

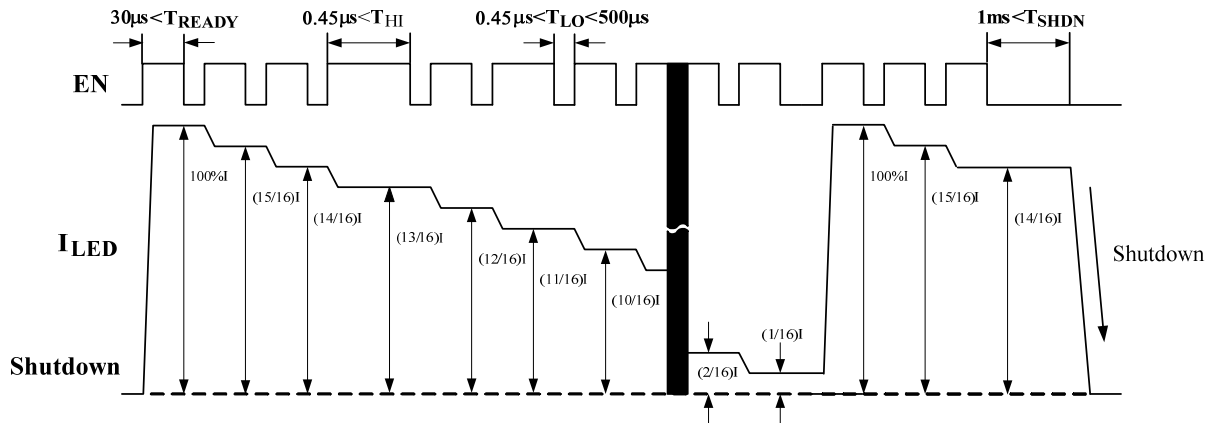
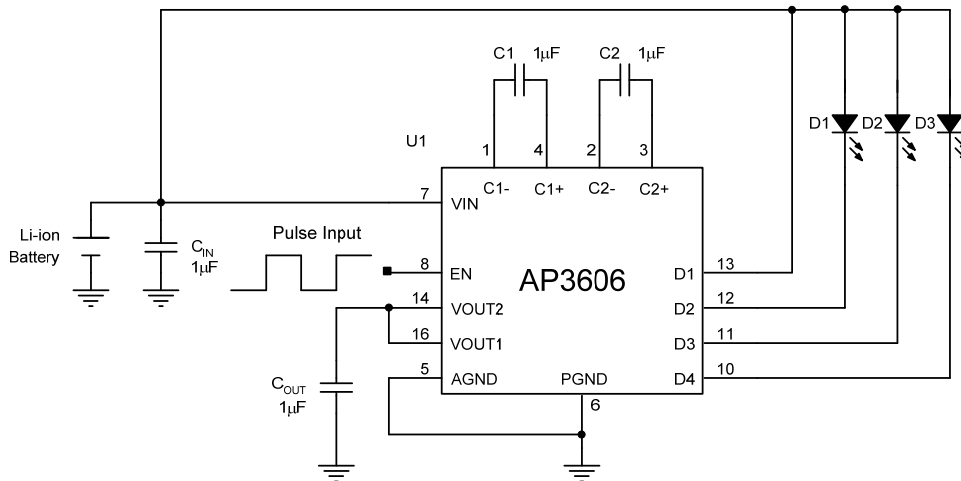

Figure 32. Digital Dimming Operating Diagram of AP3606/AP3607

Note 3: The dimming control can be achieved by applying a pulse to the EN pin. When the low level duration time of pulse is between T_{LOmin} and T_{LOmax} , and the high level duration time is larger than T_{HImin} , the LED current will decrease 1/16. If the low level duration time is larger than $T_{SHDNmax}$, the IC will be turned off. When AP3606/AP3607 is powered on, the WLED is in full brightness. And it will keep maximum current until the pulse is detected. After 15 pulses the WLED current decreases to 1/16 of full brightness. It will increase to full brightness if a pulse is added to EN pin then.

Typical Application



3 WLEDs

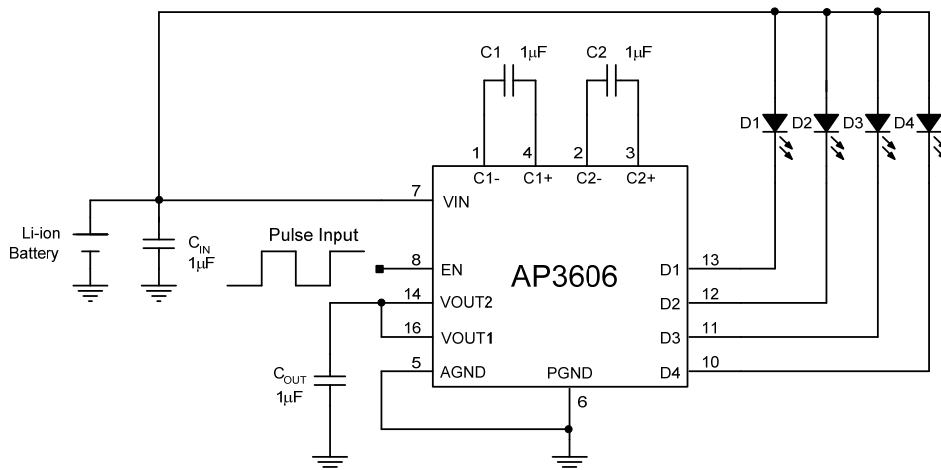

4 WLEDs

Typical Application (Continued)

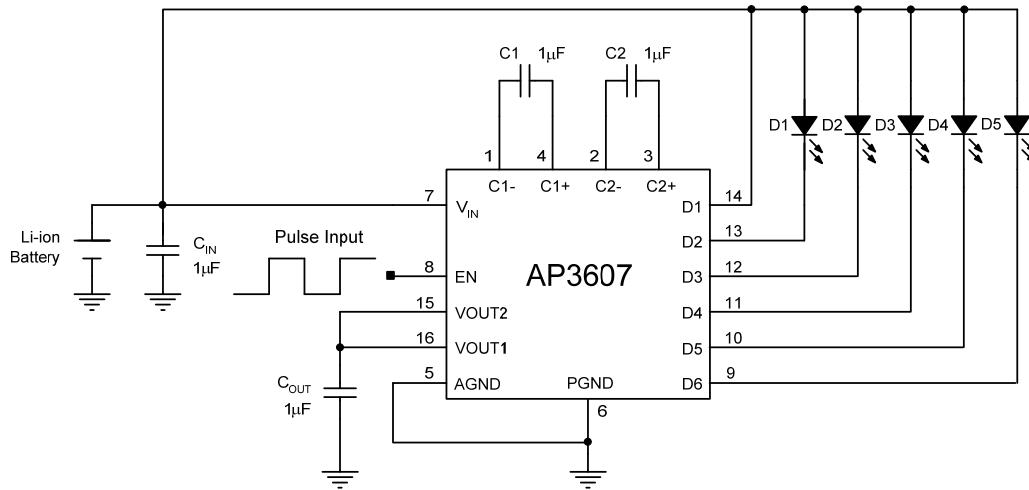

5 WLEDs

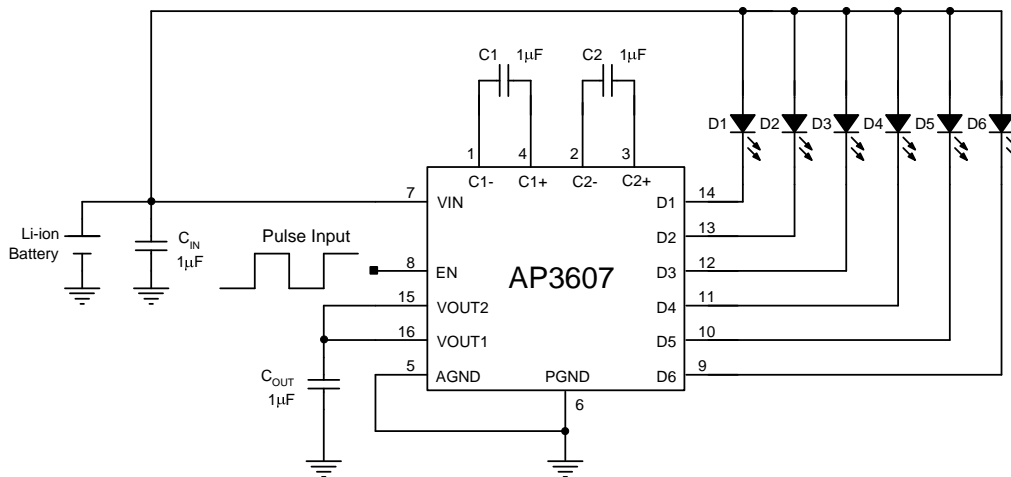

6 WLEDs

Figure 33. Typical Applications of AP3606/AP3607

Detailed application information, please refer to AP3606/AP3607 application note.

Mechanical Dimensions

QFN-3x3-16

Unit: mm(inch)

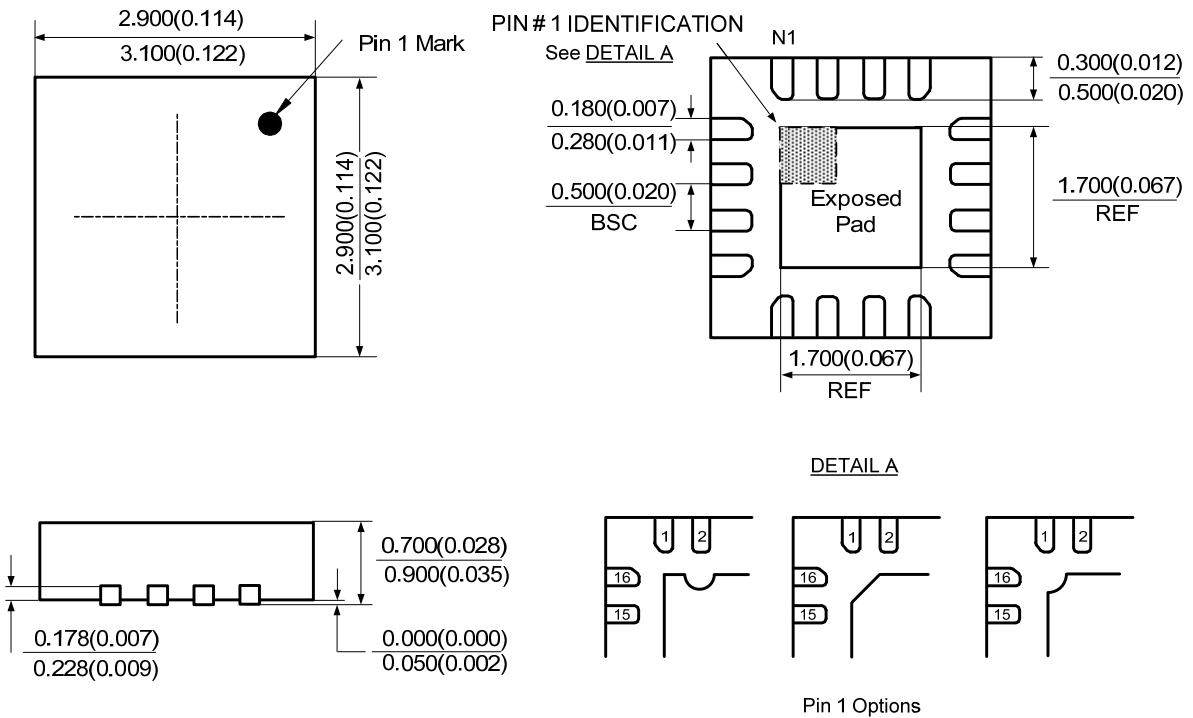



BCD Semiconductor Manufacturing Limited

<http://www.bcdsemi.com>

IMPORTANT NOTICE

BCD Semiconductor Manufacturing Limited reserves the right to make changes without further notice to any products or specifications herein. BCD Semiconductor Manufacturing Limited does not assume any responsibility for use of any its products for any particular purpose, nor does BCD Semiconductor Manufacturing Limited assume any liability arising out of the application or use of any its products or circuits. BCD Semiconductor Manufacturing Limited does not convey any license under its patent rights or other rights nor the rights of others.

MAIN SITE

- Headquarters

BCD Semiconductor Manufacturing Limited

No. 1600, Zi Xing Road, Shanghai ZiZhu Science-based Industrial Park, 200241, China
Tel: +86-21-24162266, Fax: +86-21-24162277

- Wafer Fab

Shanghai SIM-BCD Semiconductor Manufacturing Co., Ltd.

800 Yi Shan Road, Shanghai 200233, China
Tel: +86-21-6485 1491, Fax: +86-21-5450 0008

REGIONAL SALES OFFICE

Shenzhen Office

Shanghai SIM-BCD Semiconductor Manufacturing Co., Ltd., Shenzhen Office

Unit A Room 1203, Skyworth Bldg., Gaoxin Ave. 1.S., Nanshan District, Shenzhen, China
Tel: +86-755-8826 7951
Fax: +86-755-8826 7865

Taiwan Office

BCD Semiconductor (Taiwan) Company Limited

4F, 298-1, Rui Guang Road, Nei-Hu District, Taipei, Taiwan
Tel: +886-2-2656 2808
Fax: +886-2-2656 2806

USA Office

BCD Semiconductor Corp.

30920 Huntwood Ave. Hayward, CA 94544, USA
Tel : +1-510-324-2988
Fax: +1-510-324-2788

Looking for pricing, stock, or lifecycle information?

Click below to explore more details on WIN SOURCE:

-  [View AP3606FNTR on WIN SOURCE](#)
-  [Diodes Incorporated Information](#)

Optimize Your Supply Chain with WIN SOURCE Solutions

-  Global Sourcing Solution
-  Obsolete Management
-  Cost Control Management
-  Shortage Management
-  Alternative Solution
-  Excess Inventory Management