



**THE DATASHEET OF**  
**4093**



## SURFACE MOUNT AUDIO JACKS

- Mates with 2.5mm and 3.5mm plugs
- Designed for reliable interface with audio equipment including computer speakers, headphones, sound cards, cell phones, etc.
- Models available for mono and stereo applications
- Low profile, surface mount design

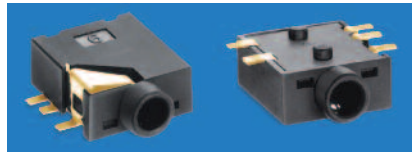

### SPECIFICATIONS

**Housing:** Polyamide, UL Rated 94V-0  
**Ground Terminal:** .012 (.30) Brass, Gold Flash ①  
**Spring Contacts:** .008 (.20) Phosphor Bronze, Gold Flash ② ⑤  
**Shunt Terminals:** .012 (.30) Brass, Gold flash ③ ④

**FOR 2.5 mm PLUGS**

**SUPPLIED ON TAPE AND REEL**

**FOR 3.5 mm PLUGS**

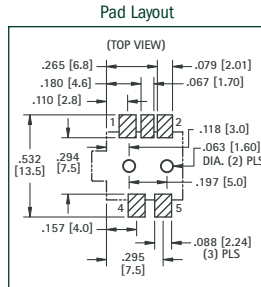
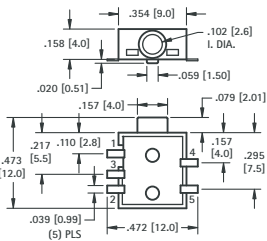

### STEREO SCHEMATIC

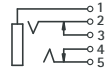

### MONO SCHEMATIC

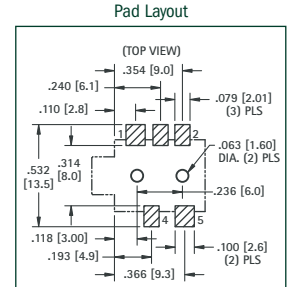
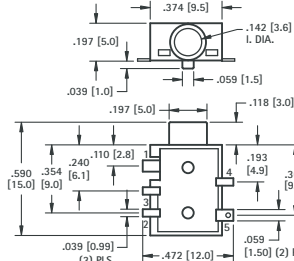
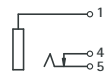

**CAT. NO. 980TR (Stereo)**

**CAT. NO. 982TR (Mono)**

**Tape Spec's:** 24mm wide; 16mm pitch  
**Reel Spec's:** 15 inch reel (1,000 pieces per reel)

**CAT. NO. 981TR (Stereo)**

**CAT. NO. 983TR (Mono)**

**Tape Spec's:** 24mm wide; 16mm pitch  
**Reel Spec's:** 15 inch reel (800 pieces per reel)

## BINDING POSTS

All Keystone binding posts are designed to prevent accidental contact with current carrying parts. They feature a "limited opening" captivated head to insure safety. Ideal for audio circuitry, R.F. circuitry, oscilloscopes, power supplies and various other applications.

These multi-purpose binding posts feature high current rating, captivated heads and anti-rotation stud mounting.

**Note:** Binding Posts accept .175" (4.5) Banana Plugs, .080" (2.08) Tip Plugs, Spade Lugs, Alligator Clips, Wires and EZ hooks.

### STANDARD BINDING POST

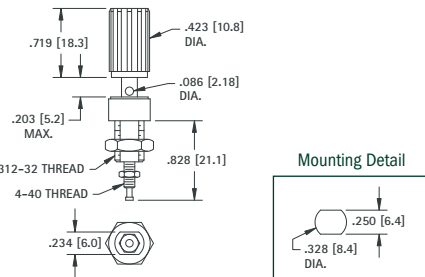

For panels up to .281 (7.1) thick

CAT. NO.	COLOR
7004	RED
7005	BLACK

**MATERIAL:**  
**Stud:** Brass per QQ-B-626  
**Plating:** Silver Plate  
**Insulation:** Nylon  
**Current Rating:** 15 Amps  
**Stud to Panel Capacitance:** 3.3 pF Nominal

### UNINSULATED BINDING POST

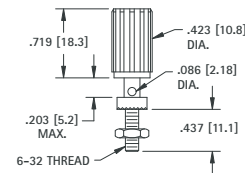

For panels up to .313 (8.0) thick

CAT. NO.	COLOR
7006	RED
7007	BLACK

**MATERIAL:**  
**Stud:** Brass per QQ-B-626  
**Plating:** Nickel Plate  
**Insulation:** Nylon  
**Current Rating:** 15 Amps, 1000V AC Working

### STANDARD DUAL HEX HEAD

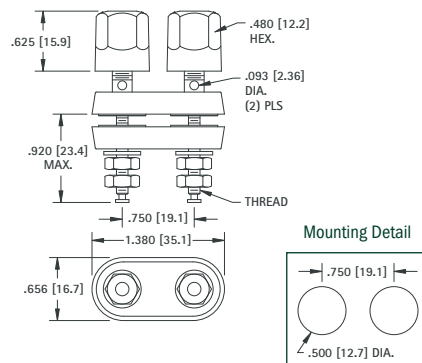

GOLD PLATE		NICKEL PLATE	
CAT. NO.	THREAD	CAT. NO.	THREAD
4108	8-32	7018	8-32
4109	10-32	7019	10-32

**MATERIAL:**  
**Stud:** Brass per ASTM B-16.  
**Insulation:** Nylon  
**Current Rating:** 30 Amps, 1000V AC Working

### STANDARD HEX HEAD

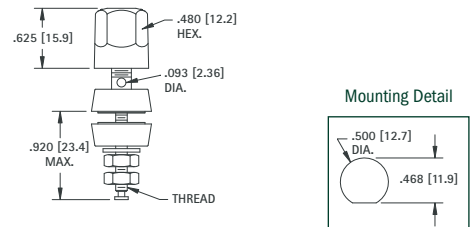



GOLD PLATE			NICKEL PLATE		
CAT. NO.	THREAD	COLOR	CAT. NO.	THREAD	COLOR
4096	8-32	RED	4091	8-32	RED
4097	8-32	BLACK	4092	8-32	BLACK
7016	10-32	RED	4093	10-32	RED
7017	10-32	BLACK	4094	10-32	BLACK
7023	10-32	WHITE	4198	10-32	WHITE
7024	10-32	YELLOW	4199	10-32	YELLOW

**MATERIAL:**  
**Stud:** Brass per ASTM B-16.  
**Insulation:** Nylon  
**Current Rating:** 30 Amps, 1000V AC Working

## Looking for pricing, stock, or lifecycle information?

Click below to explore more details on WIN SOURCE:

-  [View 4093 on WIN SOURCE](#)
-  [Keystone Electronics](#) Information

## Optimize Your Supply Chain with WIN SOURCE Solutions

-  Global Sourcing Solution
-  Obsolete Management
-  Cost Control Management
-  Shortage Management
-  Alternative Solution
-  Excess Inventory Management