



**THE DATASHEET OF  
AP3064P-G1**



## Description

The AP3064 is a high efficiency boost controller with 4-string current sources for driving WLED backlight. It operates over a wide input voltage range from 4.5V to 33V.

The current of 4 strings are simply programmed from 20mA to 220mA with an external resistor. The current matching between each string is  $\pm 1.5\%$  (Typ). Its operating frequency can be adjusted from 0.1MHz to 1MHz.

The AP3064 features cycle-by-cycle current limit, soft-start, under voltage lockout (UVLO) protection, programmable OVP, over temperature protection (OTP), open/short LED protection,  $V_{OUT}$  short/Schottky diode open protection and Schottky Diode short-circuit protection.

The AP3064 is available in SO-16 package.

## Features

- Input Voltage Range: 4.5V to 33V
- Drives up to 4 Strings in Parallel, 220mA per String
- Programmable WLED Current from 20mA to 220mA
- Adjustable Operating Frequency: 100kHz to 1MHz
- String-to-string Current Matching Accuracy:  $\pm 1.5\%$
- Built-in OCP, OTP, UVLO
- External PWM Dimming
- Open/Short LED Protection
- Programmable Soft-start
- Programmable OVP
- Schottky Diode/Inductor Short-circuit Protection
- $V_{OUT}$  Short/Schottky Diode Open Protection
- **Totally Lead-Free & Fully RoHS Compliant (Notes 1 & 2)**
- **Halogen and Antimony Free. "Green" Device (Note 3)**

- Notes:
1. No purposely added lead. Fully EU Directive 2002/95/EC (RoHS), 2011/65/EU (RoHS 2) & 2015/863/EU (RoHS 3) compliant.
  2. See <https://www.diodes.com/quality/lead-free/> for more information about Diodes Incorporated's definitions of Halogen- and Antimony-free, "Green" and Lead-free.
  3. Halogen- and Antimony-free "Green" products are defined as those which contain <900ppm bromine, <900ppm chlorine (<1500ppm total Br + Cl) and <1000ppm antimony compounds.

## Pin Assignments

(Top View)

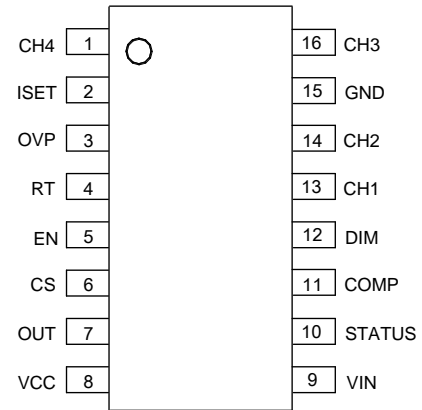

SO-16

## Applications

- LCD Monitor
- LCD Display Module
- LCD TV

**Typical Applications Circuit**

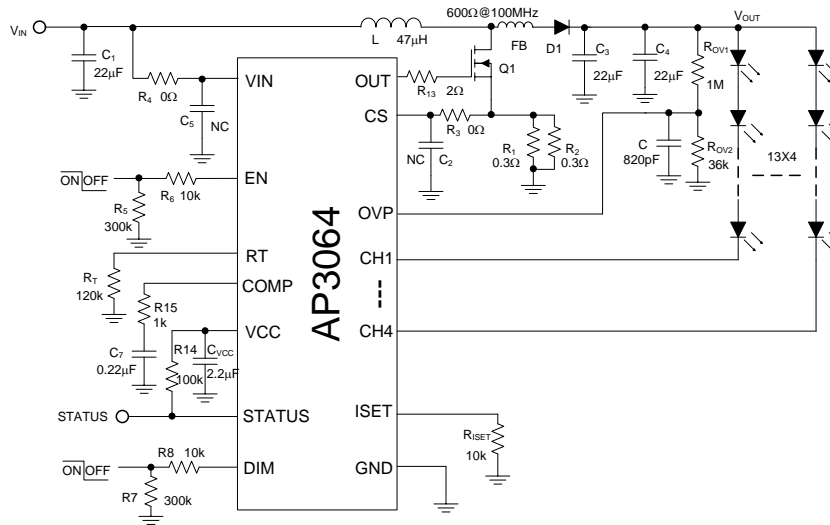

**Pin Description**

Pin Number	Pin Name	Function
1	CH4	LED current sink 4. Leave the pin open directly if not used
2	ISSET	LED current setting pin. The corresponding maximum current of all 4 strings is set through connecting a resistor from this pin to GND
3	OVP	Over voltage protection pin. When the OVP pin voltage exceeds 2.0V, the OVP is triggered and the power switch is turned off. When the OVP pin voltage drops below hysteresis voltage, the OVP is released and the power switch will resume normal operation
4	RT	Frequency control pin
5	EN	ON/OFF control pin. Forcing this pin above 2.4V enables the IC while below 0.5V shuts down the IC. When the IC is in shutdown mode, all functions are disabled to decrease the supply current below 3µA
6	CS	Power switch current sense input
7	OUT	Boost converter power switch gate output. This pin output high voltage (5V/V <sub>IN</sub> -0.5V) to drive the external N-MOSFET
8	VCC	5V linear regulator output pin. This pin should be bypassed to GND (recommend to connect with GND pin) with a ceramic capacitor
9	VIN	Supply input pin. A capacitor (typical 10µF) should be connected between the V <sub>IN</sub> and GND to keep the DC input voltage constant
10	STATUS	LED operation status output
11	COMP	Soft-start and control loop compensation
12	DIM	PWM dimming control pin. Adding a PWM signal to this pin to control LED dimming. If not used, connect it to the high level
13	CH1	LED current sink 1. Leave the pin open directly if not used
14	CH2	LED current sink 2. Leave the pin open directly if not used
15	GND	Ground
16	CH3	LED current sink 3. Leave the pin open directly if not used



### Absolute Maximum Ratings (Note 4)

Symbol	Parameter	Value	Unit
V <sub>IN</sub>	Input Voltage	-0.3 to 42	V
V <sub>CH</sub>	CH1 to CH4 Voltage	-0.3 to 65	V
V <sub>EN</sub>	EN Pin Voltage	-0.3 to 7	V
V <sub>CC</sub>	VCC Pin Voltage	-0.3 to 7	V
V <sub>CS</sub>	CS Pin Voltage	-0.3 to 7 (Note 5)	V
V <sub>COMP</sub>	COMP Pin Voltage	-0.3 to 7	V
V <sub>ISET</sub>	ISET Pin Voltage	-0.3 to 7	V
V <sub>OUT</sub>	OUT Pin Voltage	-0.3 to 7	V
V <sub>OVP</sub>	OVP Pin Voltage	-0.3 to 7	V
V <sub>RT</sub>	RT Pin Voltage	-0.3 to 7	V
V <sub>STATUS</sub>	STATUS Pin Voltage	-0.3 to 7	V
V <sub>DIM</sub>	DIM Pin Voltage	-0.3 to 7	V
V <sub>GND</sub>	GND Pin Voltage	-0.3 to 0.3	V
θ <sub>JA</sub>	Thermal Resistance (Junction to Ambient) (Note 6)	79	°C/W
θ <sub>JC</sub>	Thermal Resistance (Junction to Case) (Note 6)	10	°C/W
T <sub>J</sub>	Operating Junction Temperature	+150	°C
T <sub>STG</sub>	Storage Temperature	-65 to +150	°C
T <sub>LEAD</sub>	Lead Temperature (Soldering, 10sec)	+260	°C
—	ESD (Machine Model)	200	V
—	ESD (Human Body Model)	2000	V

Notes: 4. Stresses greater than those listed under "Absolute Maximum Ratings" may cause permanent damage to the device. These are stress ratings only, and functional operation of the device at these or any other conditions beyond those indicated under "Recommended Operating Conditions" is not implied. Exposure to "Absolute Maximum Ratings" for extended periods may affect device reliability.

5. Negative CS 100ns Transient maximum rating voltage reach to -0.4V.

6. Device mounted on 2"x2" FR-4 substrate PCB, 2oz copper, with minimum recommended pad layout.

### Recommended Operating Conditions

Symbol	Parameter	Min	Max	Unit
V <sub>IN</sub>	Input Voltage	4.5	33	V
f <sub>O</sub>	Operating Frequency	0.1	1	MHz
V <sub>CHX</sub>	LED Channel Voltage	—	60	V
I <sub>CHX</sub>	LED Channel Current	20	220	mA
f <sub>PWM</sub>	PWM Dimming Frequency	0.1	20	kHz
T <sub>A</sub>	Operating Ambient Temperature Range	-40	+85	°C

**Electrical Characteristics** ( $V_{IN} = 24V$ ,  $V_{EN} = 5V$ , Typical  $T_A = +25^\circ C$ , unless otherwise specified.)

Symbol	Parameter	Conditions	Min	Typ	Max	Unit
<b>INPUT SUPPLY</b>						
$V_{IN}$	Input Voltage	—	4.5	—	33	V
$I_Q$	Quiescent Current	No Switching	—	3	5	mA
$I_{SHTD}$	Shutdown Supply Current	$V_{EN} = V_{DD} = 0V$	—	0.1	3	$\mu A$
$V_{UVLO}$	UVLO	$V_{IN}$ Rising	3.6	3.8	4.0	V
$V_{HYS}$	UVLO Hysteresis	—	—	200	—	mV
<b>VCC SECTION</b>						
$V_{CC}$	VCC Voltage	$V_{IN} \geq 5.5V$	—	5	—	V
		$V_{IN} < 5.5V$ , Load = 10mA	—	$V_{IN}-0.1$	—	V
$t_{RISING}$	OUT Pin Rising Time (Note 7)	1nF Load	—	30	50	ns
$t_{FALLING}$	OUT Pin Falling Time (Note 7)	1nF Load	—	30	50	ns
—	Load Regulation (Note 7)	Load = 0 to 30mA	—	5	—	mV/mA
—	Line Regulation (Note 7)	$V_{IN} = 5.5$ to 24V	—	0.3	—	mV/V
<b>HIGH FREQUENCY OSCILLATOR</b>						
$f_{OSC}$	Switch Frequency (Target: 10% Variation)	$R_T = 100k\Omega$	440	520	600	kHz
—	Switch Frequency Range	—	0.1	—	1	MHz
$D_{MAX}$	Maximum Duty Cycle	$f = 500kHz$	88	90	—	%
$t_{ON-TIME}$	Minimum On-time (Note 7)	$f = 500kHz$	—	200	—	ns
<b>ENABLE LOGIC AND DIMMING LOGIC</b>						
$V_{EN\_H}$	EN High Voltage	—	2.4	—	—	V
$V_{EN\_L}$	EN Low Voltage	—	—	—	0.5	V
$V_{DIM\_H}$	PWM Logic for External Dimming	—	2.5	—	—	V
$V_{DIM\_L}$		—	—	—	0.3	V
$t_{PWM\_MIN}$	PWM Dimming Minimum Pulse Width (Note 7)	—	—	$3/f_{osc}$	—	$\mu s$
<b>POWER SWITCH DRIVE</b>						
$V_{LIMIT}$	Current Limit Threshold Voltage	—	480	540	600	mV
$V_{LIMIT2}$	D/L Short Threshold Voltage	—	720	800	880	mV
$t_{LEB}$	Current Sense LEB Time (Note 7)	—	80	100	150	ns
<b>COMPENSATION AND SOFT START (COMP PIN)</b>						
$G_{EA}$	Error Amplifier Trans-conductance	—	—	2300	—	$\mu A/V$
$I_{O\_H}$	Sourcing Current	$V_{COMP} = 0.5V$	80	120	160	$\mu A$
$I_{O\_L}$	Sinking Current	$V_{COMP} = 2V$	80	120	160	$\mu A$

Note: 7. Guaranteed by design.

**Electrical Characteristics** (Cont.  $V_{IN} = 24V$ ,  $V_{EN} = 5V$ , Typical  $T_A = +25^\circ C$ , unless otherwise specified.)

Symbol	Parameter	Conditions	Min	Typ	Max	Unit
<b>OVER-VOLTAGE PROTECTION</b>						
$V_{OVP}$	OVP Threshold Voltage	$V_{OUT}$ Rising	1.9	2.0	2.1	V
$V_{OVP\_HYS}$	OVP Hysteresis	—	—	250	—	mV
$V_{OVP\_SH}$	Shutdown Under Abnormal Condition	—	3.0	3.2	3.4	V
<b>CURRENT SOURCE</b>						
$I_{CH\_MATCH}$	LED Current Matching between Each String (Note 8)	$I_{CH} = 100mA$	—	1.5	4	%
$I_{CH}$	Regulation Current per Channel	$R_{ISET} = 12k\Omega$	92	100	108	mA
$V_{LED\_REG}$	Minimum LED Regulation Voltage	$I_{CHX} = 100mA$	—	230	—	mV
$I_{LED\_LEAK}$	CH1 to CH4 Leakage Current	$V_{EN} = 0V$ , $V_{LED} = 37V$	—	0.1	1	$\mu A$
$V_{LED\_S}$	LED Short Protection Threshold	—	6.6	7.3	8.0	V
<b>OVER-TEMPERATURE PROTECTION</b>						
$T_{OTSD}$	Thermal Shutdown Temperature (Note 7)	—	—	+160	—	$^\circ C$
$T_{HYS}$	Thermal Shutdown Recovery (Note 7)	—	—	+140	—	$^\circ C$

Notes: 7. Guaranteed by design.

$$8. I_{ST\_MATCH} = \frac{I_{MAX} - I_{MIN}}{2 \times I_{AVG}} \times 100\%$$

**Performance Characteristics** ( $V_{IN} = 24V$ ,  $V_{EN} = V_{DD} = 5V$ , 13 LEDs in series, 4 strings in parallel, 120mA/string,  $T_A = +25^\circ C$ , unless otherwise specified.)

**Frequency vs.  $R_T$**

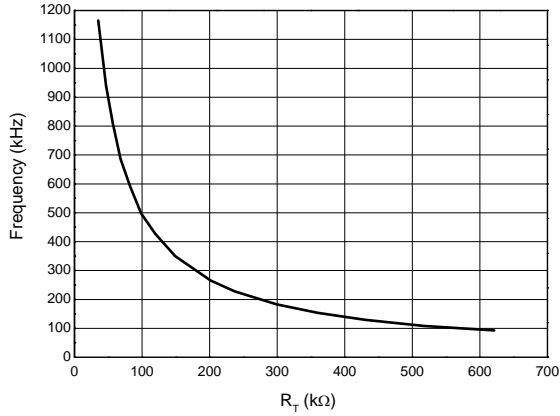

**VCC Voltage vs. Input Voltage**

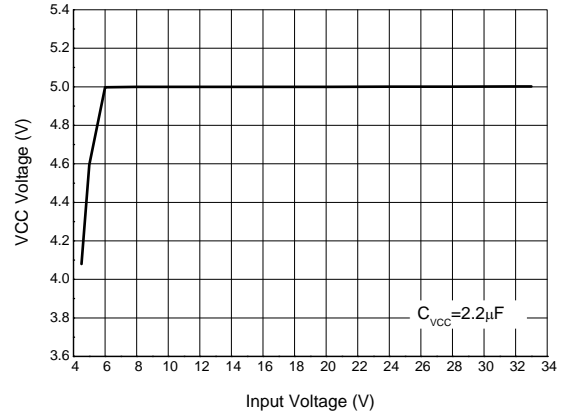

**$V_{CH}$  Regulation Voltage vs. Output Current**

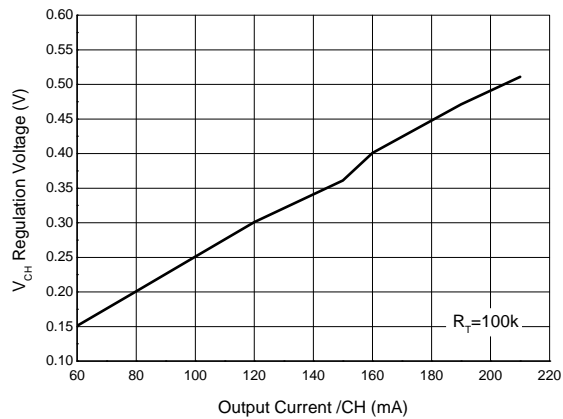

**$V_{CH}$  Regulation Voltage vs. Temperature**

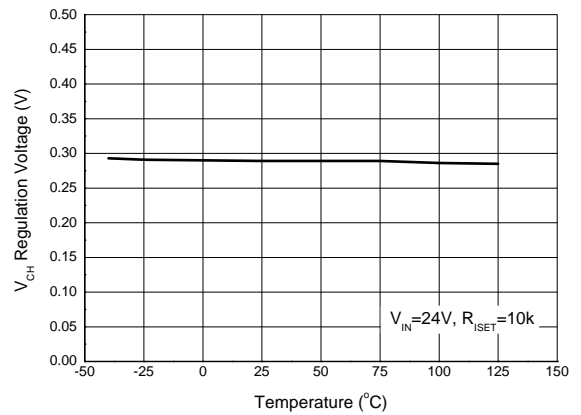

**Channel Current vs. Channel**

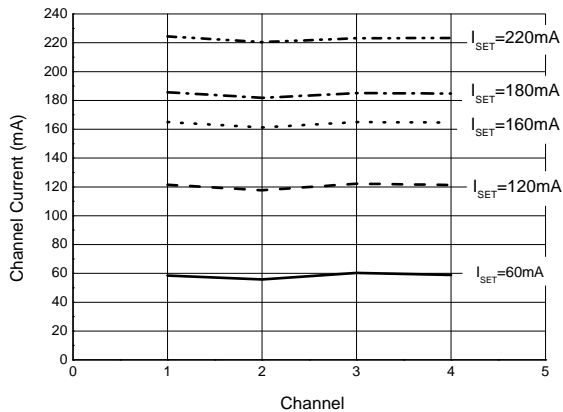

**Efficiency vs. Output Current**

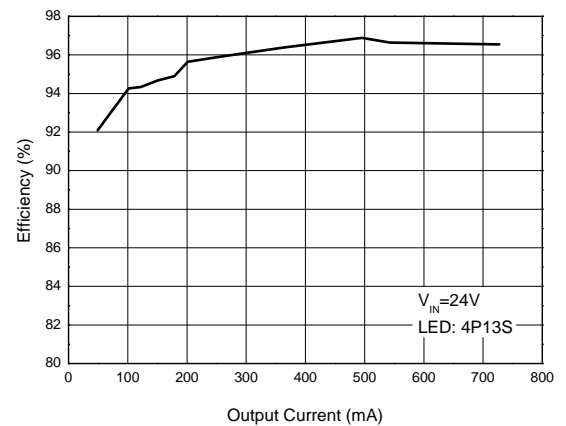

**Performance Characteristics** (Cont.  $V_{IN} = 24V$ ,  $V_{EN} = V_{DD} = 5V$ , 13 LEDs in series, 4 strings in parallel, 120mA/string,  $T_A = +25^\circ C$ , unless otherwise specified.)

**Steady State**

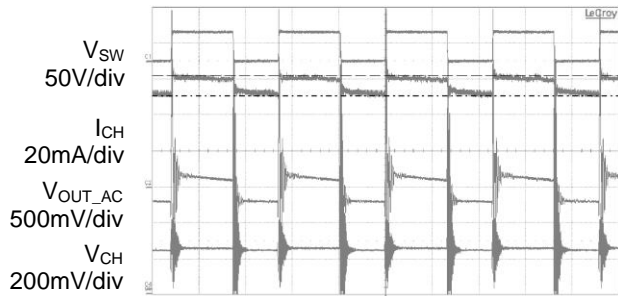

Time 1 $\mu$ s/div

**System Startup**

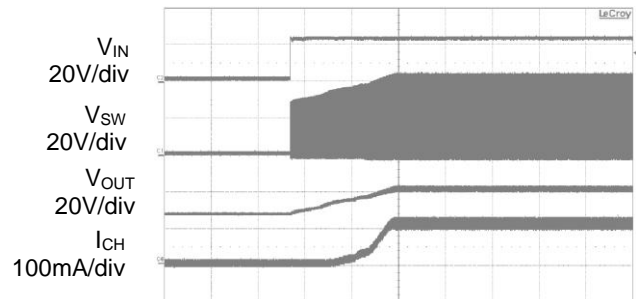

Time 20ms/div

**PWM Dimming**

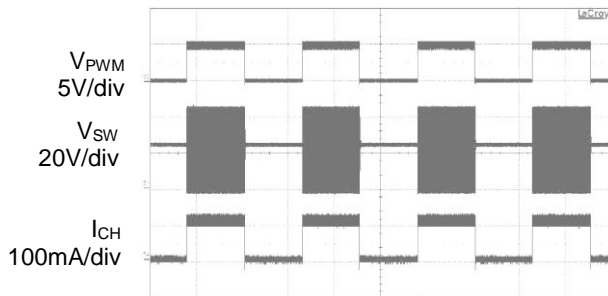

Time 2ms/div

**LED Short Protection**

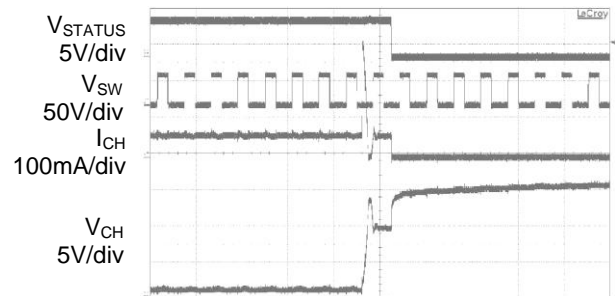

Time 10 $\mu$ s/div

**LED Open Protection**

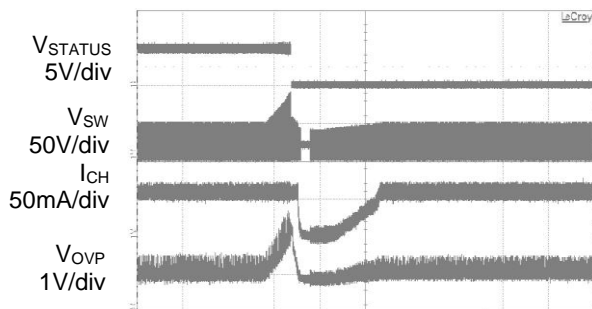

Time 50ms/div

**Schottky/Inductor Short Protection**

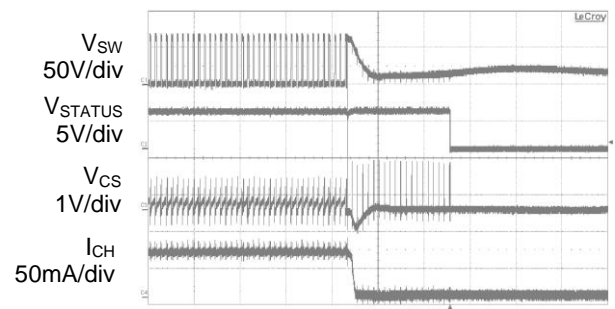

Time 50 $\mu$ s/div

NEW PRODUCT

**Performance Characteristics** (Cont.  $V_{IN} = 24V$ ,  $V_{EN} = V_{DD} = 5V$ , 13 LEDs in series, 4 strings in parallel, 120mA/string,  $T_A = +25^\circ C$ , unless otherwise specified.)

### V<sub>OUT</sub> Short/Diode Open Protection

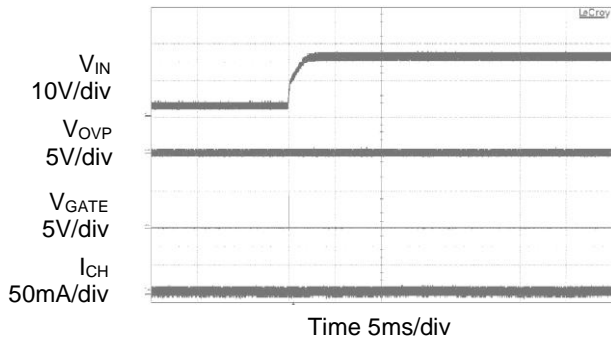

### Over Temperature Protection

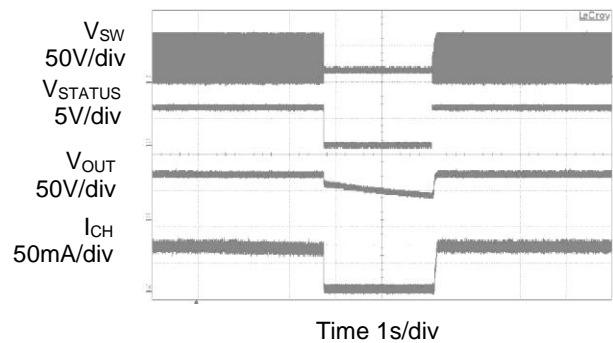

## Application Information

### 1. Enable

The AP3064 is enabled when the voltage to EN is greater than approximately 2.4V, disabled when lower than 0.5V.

### 2. Frequency Selection

An external resistor  $R_T$ , placed between RT pin and GND, can be used to set the operating frequency. The operating frequency ranges from 100kHz to 1MHz. The high frequency operation optimizes the regulator for the smallest-sized component application, while low frequency operation can help to reduce switch loss. The approximate operating frequency can be expressed as below:

$$f_{osc} [MHz] = \frac{52}{R_{RT} [K\Omega]}$$

### 3. LED Current Setting

The maximum LED current per channel can be adjusted up to 180mA via ISET pin. When  $\geq 180mA$  current is needed in application, two or more channels can be paralleled to provide larger drive current. Connect a resistor  $R_{ISET}$  between ISET pin and GND to set the reference current  $I_{SET}$ . The LED current can be expressed as below:

$$I_{LED} [mA] = \frac{1200}{R_{ISET} [K\Omega]}$$

### 4. Dimming Control

Applying a PWM signal to DIM pin to adjust the LED current, that means, the LED current of all enabled channels can be adjusted at the same time and the LED brightness can be adjusted from  $1\% \times I_{CH\_MAX}$  to  $100\% \times I_{CH\_MAX}$ . During the "high level" period of PWM signal, the LED is turned on and 100% of the current flows through LED, while during the "low level" period of the PWM signal, the LED is turned off and almost no current flows through the LED, thus changing the average current through LED and finally adjusting LED brightness. The external PWM signal frequency applied to DIM pin is allowed to be 100Hz or higher.

### 5. Status Output

After IC is enabled, STATUS will output logic low if any of the following conditions exists:

- (1) Any String is Open
- (2) LED Short Circuit Protection
- (3) Shut Down Under Abnormal Condition
- (4) Over Voltage Protection

## Application Information (Cont.)

- (5) Over Temperature Protection
- (6) Schottky Diode Short Protection
- (7)  $V_{OUT}$  Short/Open Schottky Diode Protection

### 6. Over Voltage Protection

The AP3064 integrates an OVP circuit. The OVP pin is connected to the center tap of voltage-divider ( $R_{OV1}$  and  $R_{OV2}$ ) that placed between high voltage output and GND. If the voltage on OVP pin exceeds 2.0V, which may results from open loop or excessive output voltage, all the functions of AP3064 will be disabled with output voltage falling. The OVP hysteresis is 250mV. The formulas of OVP can be expressed as below:

$$V_{OVP} = \frac{(R_{OV1} + R_{OV2}) \times 2.0V}{R_{OV2}}$$

### 7. Over Current Protection

The AP3064 integrates an OCP circuit. The CS pin is connected to the voltage-sensor ( $R_{CS}$ ) that placed between the Drain of MOS and GND. If the voltage on CS pin exceeds 0.54V, it is turned off immediately and will not turn on until the next cycle begins.

### 8. LED Short-Circuit Protection

The AP3064 integrates an LED Short-circuit protection circuit. If the voltage at any of the CH1-4 pins exceeds a threshold of approximately 7.3V during normal operation, the corresponding string is turned off and is latched off. Toggle  $V_{IN}$  and/or EN to reset the latch. LED short detecting logic priority is lower than open LED and OVP logic. The LED short detecting is triggered when  $0.1V < V_{LED\_MIN}$  under dimming on mode, disabled when LED open occurs until output voltage resumes to the regulated voltage.

### 9. LED Open-circuit Protection

The AP3064 integrates an LED Open-circuit Protection circuit. When any LED string is open,  $V_{OUT}$  will boost up until the voltage at OVP pin reaches an approximate 2.0V threshold. The IC will automatically ignore the open string whose corresponding pin voltage is less than 100mV and the remaining string will continue operation. If all the strings are open and the voltage at OVP reaches a threshold of 2.0V, the MOSFET drive GATE will turn off and IC will shut down and latch.

### 10. $V_{OUT}$ Short / Open Schottky Diode Protection

The AP3064 monitors the OVP pin, if the OVP pin voltage is less than 0.1V, MOSFET drive output will turn off. This protects the converter if the output Schottky diode is open or  $V_{OUT}$  is shorted to ground.

### 11. Under Voltage Lockout

The AP3064 provides an under voltage lockout circuit to prevent it from undefined status when startup. The UVLO circuit shuts down the device when  $V_{CC}$  drops below 3.6V. The UVLO circuit has 200mV hysteresis, which means the device starts up again when  $V_{CC}$  rise to 3.8V.

### 12. Over Temperature Protection

The AP3064 features Over Temperature Protection, if the junction temperature exceeds approximately +160°C, the IC will shut down until the junction temperature is less than approximately +140°C. When the IC is released from over temperature shutdown, it will start a soft-start process.

### 13. Schottky Diode/Inductor Short Circuit Protection

The AP3064 features Schottky diode/inductor short-circuit protection circuit. When CS pin voltage exceeds 0.8V for greater than 16 switching clocks, the IC will latch. The voltage of CS is monitored after a short delay of LEB.

### 14. Shut Down under Abnormal Condition

The AP3064 features shutdown under abnormal condition protection circuit. When OVP pin voltage exceeds 3.2V, the IC will latch. Toggle EN to restart the IC. This feature can be used for any other protection to shut down the IC.

**Ordering Information**

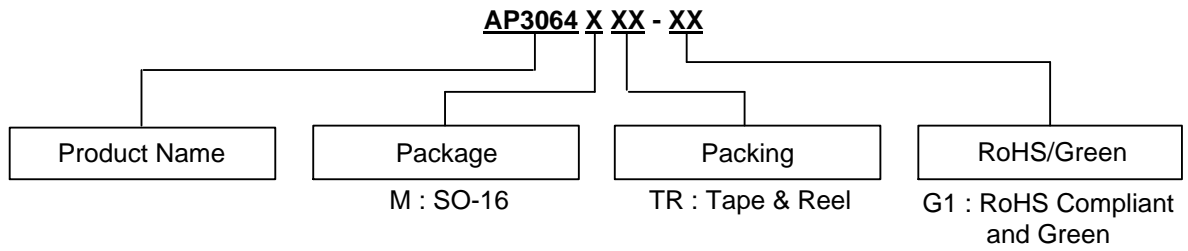

Package	Temperature Range	Part Number	Marking ID	Packing
SO-16	-40 to +85°C	AP3064MTR-G1	AP3064M-G1	4000/13" Tape & Reel

**Marking Information**

(Top View)



First Line: Logo and Marking ID  
 Second Line: Date Code  
 Y: Year  
 WW: Work Week of Molding  
 A: Assembly House Code  
 XX: 7<sup>th</sup> and 8<sup>th</sup> Digits of Batch Number

**Package Outline Dimensions**

Please see <http://www.diodes.com/package-outlines.html> for the latest version.

**SO-16**

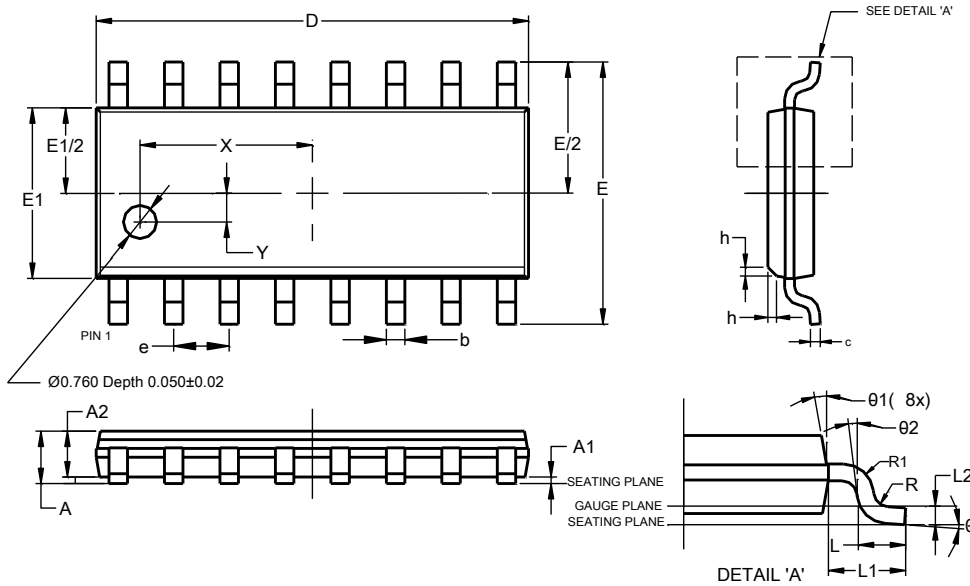

SO-16			
Dim	Min	Max	Typ
A	--	1.260	--
A1	0.10	0.23	--
A2	1.02	--	--
b	0.31	0.51	--
c	0.10	0.25	--
D	9.80	10.00	--
E	5.90	6.10	--
E1	3.80	4.00	--
e	1.27 BSC		
h	0.15	0.25	0.20
L	0.40	1.27	--
L1	1.04 REF		
L2	0.25 BSC		
R	0.07	--	--
R1	0.07	--	--
X	3.945 REF		
Y	0.661 REF		
theta	0°	8°	--
theta1	5°	15°	--
theta2	0°	--	--
All Dimensions in mm			

**Suggested Pad Layout**

Please see <http://www.diodes.com/package-outlines.html> for the latest version.

**SO-16**

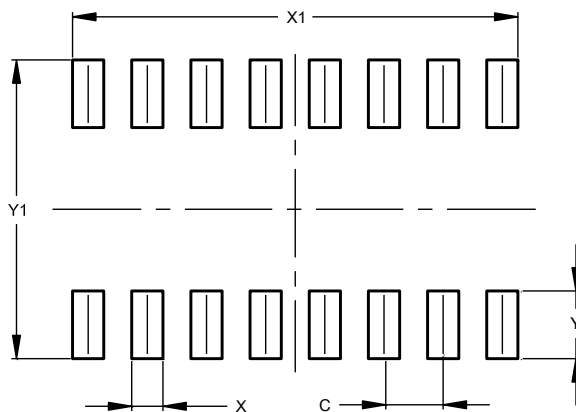

Dimensions	Value (in mm)
C	1.270
X	0.670
X1	9.560
Y	1.450
Y1	6.400

NEW PRODUCT

**IMPORTANT NOTICE**

DIODES INCORPORATED MAKES NO WARRANTY OF ANY KIND, EXPRESS OR IMPLIED, WITH REGARDS TO THIS DOCUMENT, INCLUDING, BUT NOT LIMITED TO, THE IMPLIED WARRANTIES OF MERCHANTABILITY AND FITNESS FOR A PARTICULAR PURPOSE (AND THEIR EQUIVALENTS UNDER THE LAWS OF ANY JURISDICTION).

Diodes Incorporated and its subsidiaries reserve the right to make modifications, enhancements, improvements, corrections or other changes without further notice to this document and any product described herein. Diodes Incorporated does not assume any liability arising out of the application or use of this document or any product described herein; neither does Diodes Incorporated convey any license under its patent or trademark rights, nor the rights of others. Any Customer or user of this document or products described herein in such applications shall assume all risks of such use and will agree to hold Diodes Incorporated and all the companies whose products are represented on Diodes Incorporated website, harmless against all damages.

Diodes Incorporated does not warrant or accept any liability whatsoever in respect of any products purchased through unauthorized sales channel. Should Customers purchase or use Diodes Incorporated products for any unintended or unauthorized application, Customers shall indemnify and hold Diodes Incorporated and its representatives harmless against all claims, damages, expenses, and attorney fees arising out of, directly or indirectly, any claim of personal injury or death associated with such unintended or unauthorized application.

Products described herein may be covered by one or more United States, international or foreign patents pending. Product names and markings noted herein may also be covered by one or more United States, international or foreign trademarks.

This document is written in English but may be translated into multiple languages for reference. Only the English version of this document is the final and determinative format released by Diodes Incorporated.

**LIFE SUPPORT**

Diodes Incorporated products are specifically not authorized for use as critical components in life support devices or systems without the express written approval of the Chief Executive Officer of Diodes Incorporated. As used herein:

A. Life support devices or systems are devices or systems which:

1. are intended to implant into the body, or
2. support or sustain life and whose failure to perform when properly used in accordance with instructions for use provided in the labeling can be reasonably expected to result in significant injury to the user.

B. A critical component is any component in a life support device or system whose failure to perform can be reasonably expected to cause the failure of the life support device or to affect its safety or effectiveness.

Customers represent that they have all necessary expertise in the safety and regulatory ramifications of their life support devices or systems, and acknowledge and agree that they are solely responsible for all legal, regulatory and safety-related requirements concerning their products and any use of Diodes Incorporated products in such safety-critical, life support devices or systems, notwithstanding any devices- or systems-related information or support that may be provided by Diodes Incorporated. Further, Customers must fully indemnify Diodes Incorporated and its representatives against any damages arising out of the use of Diodes Incorporated products in such safety-critical, life support devices or systems.

Copyright © 2018, Diodes Incorporated

[www.diodes.com](http://www.diodes.com)

## Looking for pricing, stock, or lifecycle information?

Click below to explore more details on WIN SOURCE:

- ⊖ [View AP3064P-G1 on WIN SOURCE](#)
- ⊖ [Diodes Incorporated Information](#)

## Optimize Your Supply Chain with WIN SOURCE Solutions

- ✓ Global Sourcing Solution
- ✓ Obsolete Management
- ✓ Cost Control Management
- ✓ Shortage Management
- ✓ Alternative Solution
- ✓ Excess Inventory Management