



**THE DATASHEET OF  
CAT8900B125TBGT3**



# ON Semiconductor

## Is Now

The logo for onsemi, featuring the word "onsemi" in a dark teal, lowercase, sans-serif font. The letter "i" is stylized with a white dot and a teal vertical bar. A small orange triangle is positioned above the top right of the "i". A trademark symbol (TM) is located to the right of the logo.

To learn more about onsemi™, please visit our website at  
[www.onsemi.com](http://www.onsemi.com)

---

**onsemi** and **onsemi** and other names, marks, and brands are registered and/or common law trademarks of Semiconductor Components Industries, LLC dba "**onsemi**" or its affiliates and/or subsidiaries in the United States and/or other countries. **onsemi** owns the rights to a number of patents, trademarks, copyrights, trade secrets, and other intellectual property. A listing of **onsemi** product/patent coverage may be accessed at [www.onsemi.com/site/pdf/Patent-Marking.pdf](http://www.onsemi.com/site/pdf/Patent-Marking.pdf). **onsemi** reserves the right to make changes at any time to any products or information herein, without notice. The information herein is provided "as-is" and **onsemi** makes no warranty, representation or guarantee regarding the accuracy of the information, product features, availability, functionality, or suitability of its products for any particular purpose, nor does **onsemi** assume any liability arising out of the application or use of any product or circuit, and specifically disclaims any and all liability, including without limitation special, consequential or incidental damages. Buyer is responsible for its products and applications using **onsemi** products, including compliance with all laws, regulations and safety requirements or standards, regardless of any support or applications information provided by **onsemi**. "Typical" parameters which may be provided in **onsemi** data sheets and/or specifications can and do vary in different applications and actual performance may vary over time. All operating parameters, including "Typicals" must be validated for each customer application by customer's technical experts. **onsemi** does not convey any license under any of its intellectual property rights nor the rights of others. **onsemi** products are not designed, intended, or authorized for use as a critical component in life support systems or any FDA Class 3 medical devices or medical devices with a same or similar classification in a foreign jurisdiction or any devices intended for implantation in the human body. Should Buyer purchase or use **onsemi** products for any such unintended or unauthorized application, Buyer shall indemnify and hold **onsemi** and its officers, employees, subsidiaries, affiliates, and distributors harmless against all claims, costs, damages, and expenses, and reasonable attorney fees arising out of, directly or indirectly, any claim of personal injury or death associated with such unintended or unauthorized use, even if such claim alleges that **onsemi** was negligent regarding the design or manufacture of the part. **onsemi** is an Equal Opportunity/Affirmative Action Employer. This literature is subject to all applicable copyright laws and is not for resale in any manner. Other names and brands may be claimed as the property of others.

# CAT8900

## Precision Analog Voltage References

The CAT8900 is a high precision voltage reference providing very accurate voltage regulation with low supply current consumption.

CAT8900 is ideal for use in battery powered systems where operating current needs to be minimized and there can be a great variation in supply voltages. It will source or sink up to 10 mA of load current, and can for most applications, forgo the use of an output bypass capacitor. The device is supplied in a space saving three terminal SOT-23 package.

### Features

- Reference Voltages:  
1.024 V, 1.200 V, 1.250 V, 1.800 V,  
2.048 V, 2.500 V, 2.600 V,  
3.000 V, 3.300 V
- Low Supply Current: 450 nA (Typical)
- Initial Accuracy:  
Class B:  $\pm 1.0$  mV  
Class C:  $\pm 2.5$  mV  
Class D:  $\pm 5.0$  mV
- Drift Performance: 50 ppm/ $^{\circ}$ C
- SOT-23 3-Lead Package
- This Device is Pb-Free, Halogen Free/BFR Free, and RoHS Compliant

### Typical Applications

- Battery Powered Systems
- A/D and D/A Converters
- Precision Regulator Systems
- Power Supplies
- Portable Medical Equipment

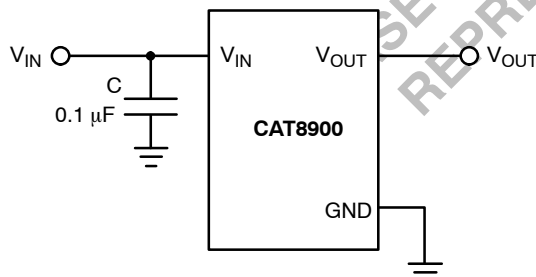
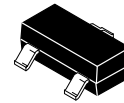

Figure 1. Application Circuit



ON Semiconductor®

<http://onsemi.com>



SOT23-3  
TP, TB SUFFIX  
CASE 527AG

### MARKING DIAGRAM

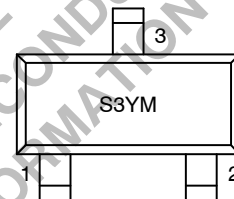

S3 = Specific Device Code  
Y = Production Year  
(Last Digit)  
M = Production Month  
(1 - 9, A, B, C)

### PIN CONNECTIONS

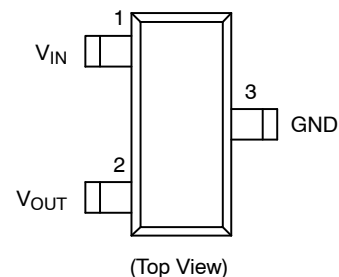

### PIN FUNCTIONS

Pin No.	Pin Name	Function
1	V <sub>IN</sub>	Supply Voltage Input
2	V <sub>OUT</sub>	Output Voltage
3	GND	Ground

### ORDERING INFORMATION

See detailed ordering and shipping information in the package dimensions section on page 2 of this data sheet.

# CAT8900

**Table 1. ORDERING INFORMATION**

Orderable Part Number	Initial Accuracy (±mV)	Initial Accuracy (%)	V <sub>OUT</sub> Voltage (V) (Note 1)	Package	Shipping <sup>†</sup>
CAT8900B102TBGT3	1.0	0.10%	1.024	SOT-23	3,000
CAT8900C102TBGT3	2.5	0.24%			
CAT8900D102TBGT3	5.0	0.49%			
CAT8900B120TBGT3	1.0	0.08%	1.200		
CAT8900C120TBGT3	2.5	0.21%			
CAT8900D120TBGT3	5.0	0.42%			
CAT8900B125TBGT3	1.0	0.08%	1.250		
CAT8900C125TBGT3	2.5	0.20%			
CAT8900D125TBGT3	5.0	0.40%			
CAT8900B180TBGT3	1.0	0.06%	1.800		
CAT8900C180TBGT3	2.5	0.14%			
CAT8900D180TBGT3	5.0	0.28%			
CAT8900B204TBGT3	1.0	0.05%	2.048		
CAT8900C204TBGT3	2.5	0.12%			
CAT8900D204TBGT3	5.0	0.24%			
CAT8900B250TBGT3	1.0	0.04%	2.500		
CAT8900C250TBGT3	2.5	0.10%			
CAT8900D250TBGT3	5.0	0.20%			
CAT8900B260TBGT3	1.0	0.04%	2.600		
CAT8900C260TBGT3	2.5	0.10%			
CAT8900D260TBGT3	5.0	0.19%			
CAT8900B300TBGT3	1.0	0.03%	3.000		
CAT8900C300TBGT3	2.5	0.08%			
CAT8900D300TBGT3	5.0	0.17%			
CAT8900B330TBGT3	1.0	0.03%	3.300		
CAT8900C330TBGT3	2.5	0.08%			
CAT8900D330TBGT3	5.0	0.15%			

1. Contact factory for availability of these and other custom voltages.

†For information on tape and reel specifications, including part orientation and tape sizes, please refer to our Tape and Reel Packaging Specifications Brochure, BRD8011/D.

# CAT8900

**Table 2. ABSOLUTE MAXIMUM RATINGS** (Note 2)

Rating	Value	Unit
$V_{IN}$	6.5	V
Storage Temperature Range	-55 to +125	°C
Junction Temperature Range	+150	°C

Stresses exceeding Maximum Ratings may damage the device. Maximum Ratings are stress ratings only. Functional operation above the Recommended Operating Conditions is not implied. Extended exposure to stresses above the Recommended Operating Conditions may affect device reliability.

2. Maximum terminal current is bounded by the maximum current handling of the switches, maximum power dissipation of the package.

**Table 3. RECOMMENDED OPERATING CONDITIONS**

Rating	Value	Unit
Temperature Range	-40 to +85	°C

**Table 4. ELECTRICAL CHARACTERISTICS**

$V_{IN} = 3.0\text{ V}$ ,  $I_{OUT} = 0\text{ mA}$ ,  $C_{OUT} = 0.001\text{ }\mu\text{F}$ ,  $-40^{\circ}\text{C}$  to  $+85^{\circ}\text{C}$  unless specified otherwise.

Parameter	Test Conditions	Symbol	Min	Typ	Max	Unit
Output Voltage	CAT8900x102 CAT8900x120 CAT8900x125 CAT8900x180 CAT8900x204 CAT8900x250 CAT8900x260 CAT8900x300 ( $V_{IN} = 5.0\text{ V}$ ) CAT8900x330 ( $V_{IN} = 5.0\text{ V}$ )	$V_{OUT}$		1.024 1.200 1.250 1.800 2.048 2.500 2.600 3.000 3.300		V
Initial Accuracy	Grade B ( $T_A = 25^{\circ}\text{C}$ )		-1.0		+1.0	mV
	Grade C ( $T_A = 25^{\circ}\text{C}$ )		-2.5		+2.5	
	Grade D ( $T_A = 25^{\circ}\text{C}$ )		-5.0		+5.0	
Output Voltage Noise (Note 3)	$f = 0.1\text{ Hz to }10\text{ Hz}$			50		$\mu\text{Vp-p}$
Output Voltage Temperature Drift	$-40^{\circ}\text{C to }85^{\circ}\text{C}$	$\Delta V_{OUT} \div \Delta T$		20	50	$\text{ppm}/^{\circ}\text{C}$
Thermal Hysteresis (Note 3)	$\Delta T_A = 125^{\circ}\text{C}$	$\Delta V_{OUT} \div \Delta T_A$		100		ppm
Line Regulation	$2.7\text{ V} < V_{IN} < 5.5\text{ V}$	$\Delta V_{OUT} \div \Delta V_{IN}$		30	100	$\mu\text{V/V}$
Dropout Voltage	$V_{IN} = 3.0\text{ V}$ , CAT8900x250	$V_{DO}$		1.0	2.5	mV
Load Regulation Sourcing	$0\text{ mA} < I_{LOAD} < 10\text{ mA}$ ; $V_{IN} = 3\text{ V}$	$\Delta V_{OUT} \div \Delta I_{LOAD}$		100	250	$\mu\text{V/mA}$
Sinking	$-10\text{ mA} < I_{LOAD} < 0\text{ mA}$ ; $V_{IN} = 3\text{ V}$			150	350	$\mu\text{V/mA}$
Long Term Stability (Note 3)	$T_A = 25^{\circ}\text{C}$ ; first 1000 hours	$\Delta V_{OUT} \div \Delta t$		50		ppm
Output Current		$I_{LOAD}$	-10		+10	mA
Short Circuit Current (Note 3)	$T_A = 25^{\circ}\text{C}$ $V_{OUT}$ pin shorted to GND $V_{OUT}$ pin shorted to $V_{IN}$	$I_{SC}$		40	60	mA
				20	40	
Turn-on Settling Time	$0.1\% @ V_{IN} = 3\text{ V}$ ; $C_L = 0\text{ pF}$			2		ms

## POWER SUPPLY

Input Voltage	$I_L = 0\text{ mA}$	$V_{IN}$	2.7		5.5	V
Supply current		$I_{IN}$		450	800	nA

3. Guaranteed by design.

# CAT8900

## TYPICAL CHARACTERISTICS

( $V_{IN} = 3.0\text{ V}$ ,  $I_{OUT} = 0\text{ mA}$ , ambient temperature of  $25^{\circ}\text{C}$ , unless specified otherwise.)

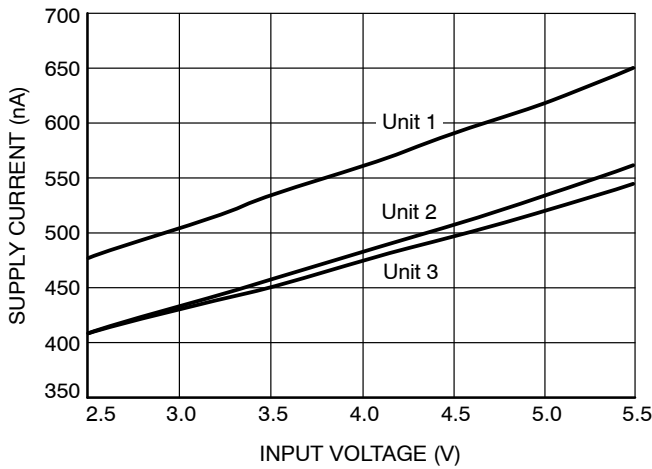

Figure 2. Supply Current vs. Input Voltage

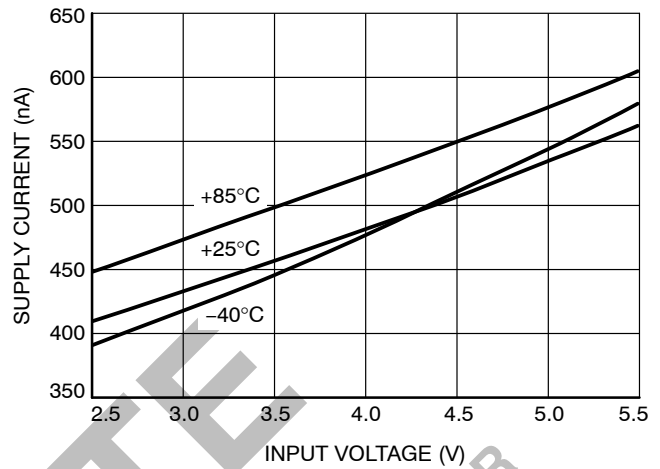

Figure 3. Supply Current vs. Input Voltage Over Temperature

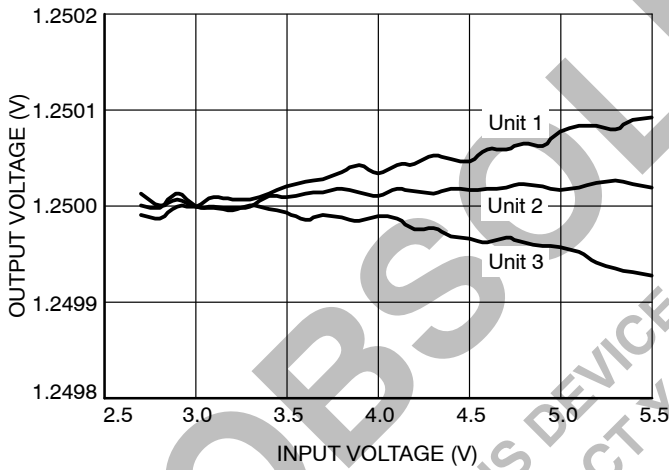

Figure 4. Line Regulation

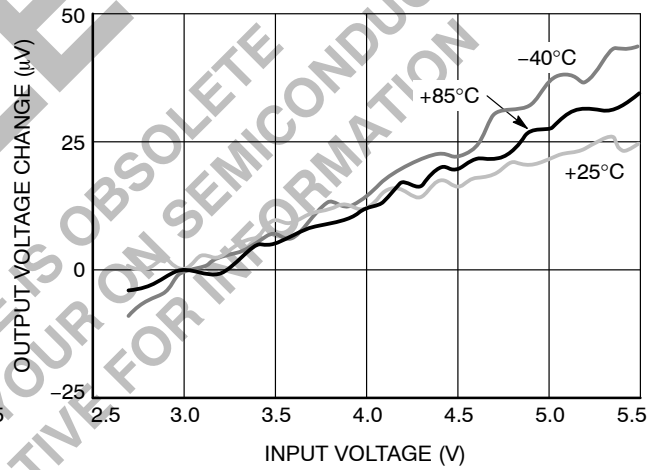

Figure 5. Line Regulation Over Temperature Normalized

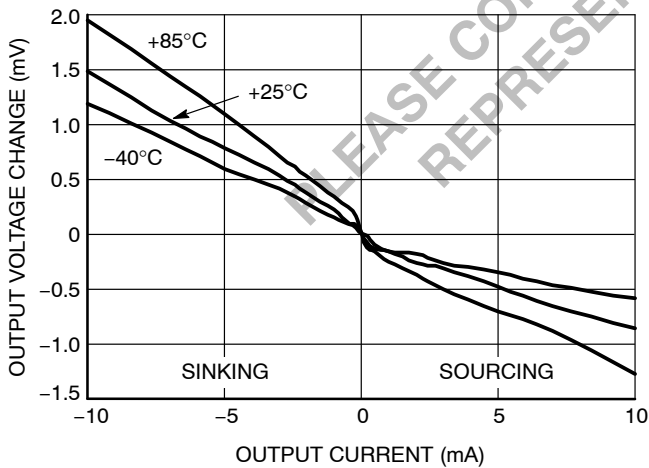

Figure 6. Load Regulation Over Temperature

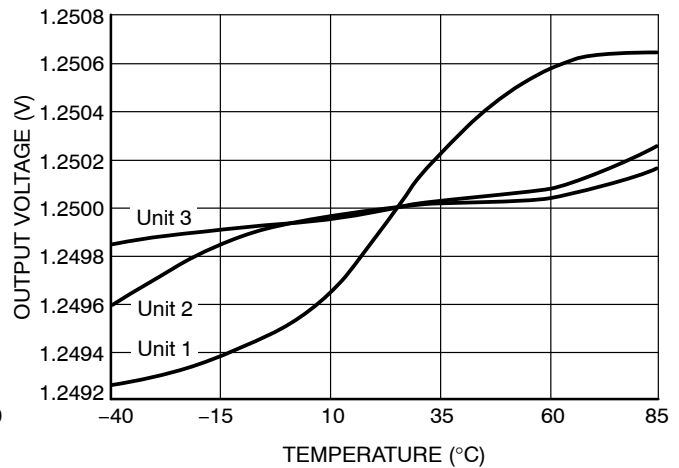

Figure 7. Output Voltage vs. Temperature Normalized

TYPICAL CHARACTERISTICS

( $V_{IN} = 3.0\text{ V}$ ,  $I_{OUT} = 0\text{ mA}$ , ambient temperature of  $25^{\circ}\text{C}$ , unless specified otherwise.)

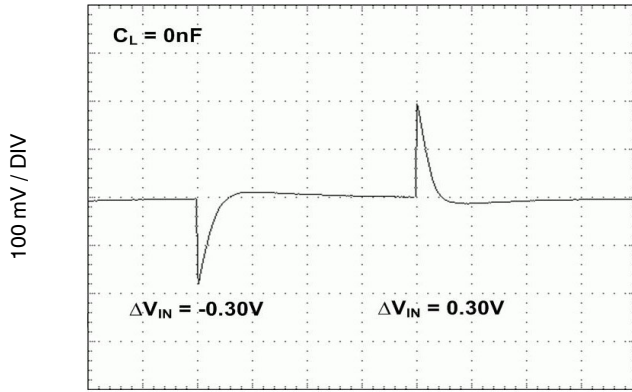

Figure 8. Line Transient Response

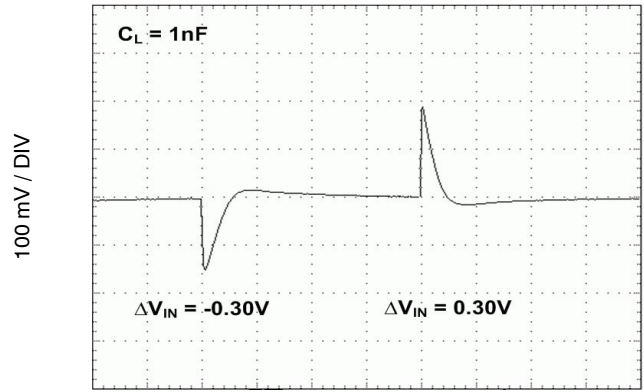

Figure 9. Line Transient Response with Capacitive Load

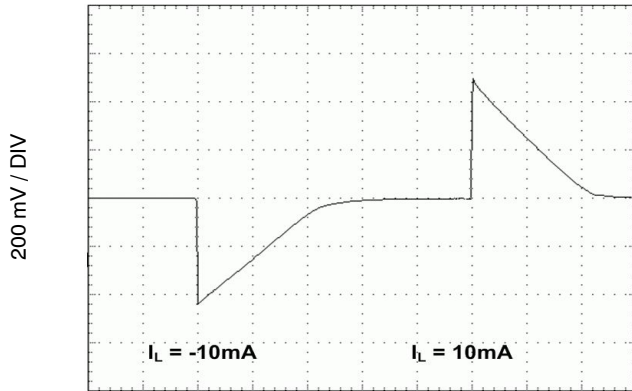

Figure 10. Load Transient Response

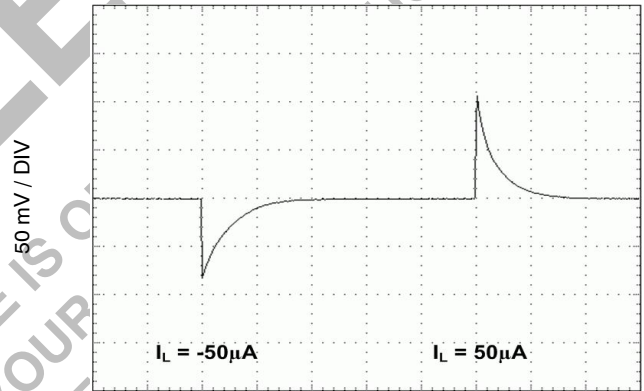

Figure 11. Load Transient Response

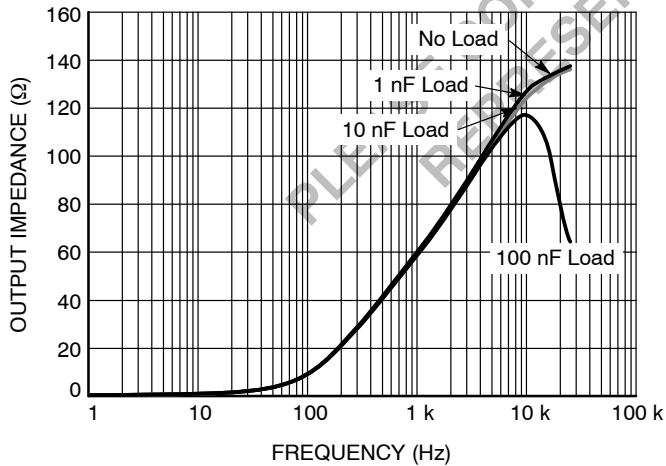

Figure 12. Output Impedance vs. Frequency

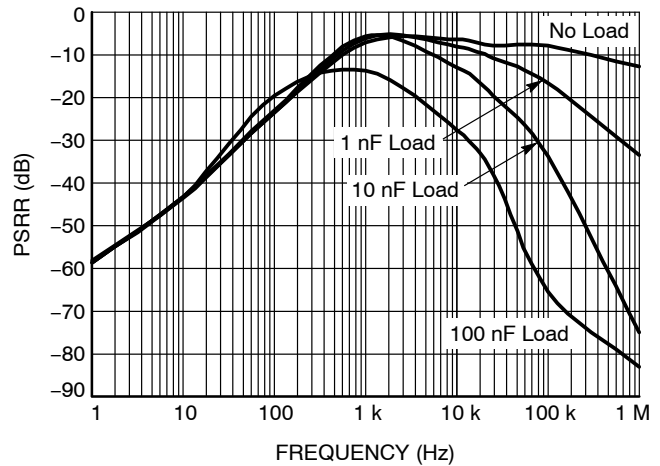

Figure 13. Power Supply Rejection Ratio vs. Frequency

# CAT8900

## TYPICAL CHARACTERISTICS

( $V_{IN} = 3.0\text{ V}$ ,  $I_{OUT} = 0\text{ mA}$ , ambient temperature of  $25^{\circ}\text{C}$ , unless specified otherwise.)

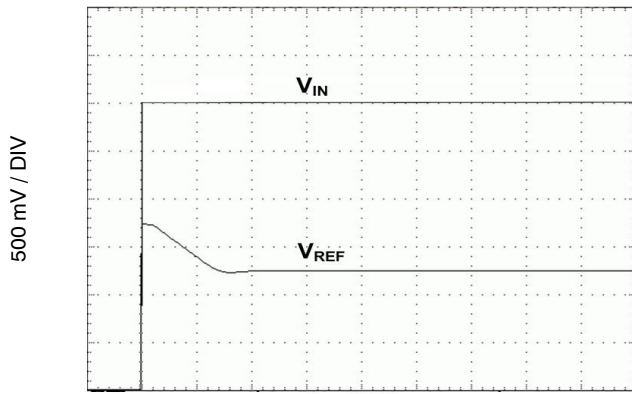

Figure 14. Turn-On Time

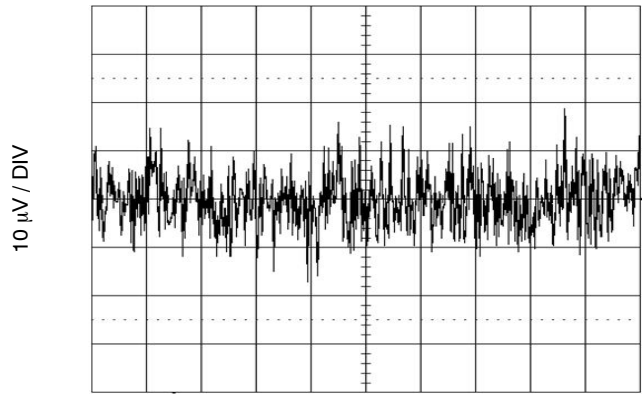

Figure 15. Output Noise

**OBSOLETE**  
THIS DEVICE IS OBSOLETE  
PLEASE CONTACT YOUR ON SEMICONDUCTOR  
REPRESENTATIVE FOR INFORMATION

# CAT8900

## PACKAGE DIMENSIONS

SOT-23, 3 Lead  
CASE 527AG-01  
ISSUE O

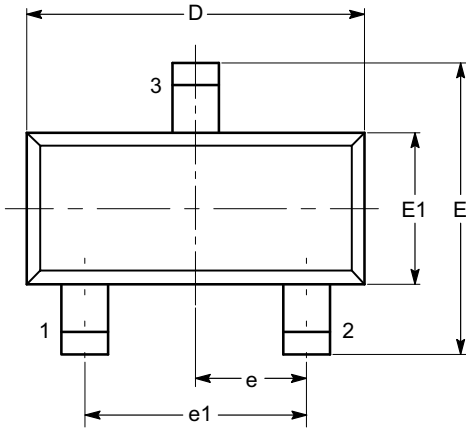

TOP VIEW

SYMBOL	MIN	NOM	MAX
A	0.89		1.12
A1	0.013		0.10
b	0.37		0.50
c	0.085		0.18
D	2.80		3.04
E	2.10		2.64
E1	1.20		1.40
e	0.95 BSC		
e1	1.90 BSC		
L	0.40 REF		
L1	0.54 REF		
$\theta$	0°		8°

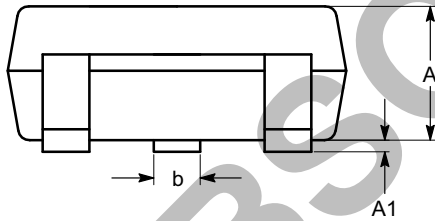

SIDE VIEW

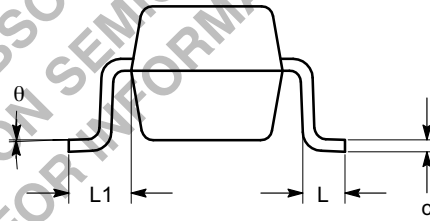

END VIEW

**Notes:**

- (1) All dimensions are in millimeters. Angles in degrees.
- (2) Complies with JEDEC TO-236.

ON Semiconductor and are registered trademarks of Semiconductor Components Industries, LLC (SCILLC). SCILLC reserves the right to make changes without further notice to any products herein. SCILLC makes no warranty, representation or guarantee regarding the suitability of its products for any particular purpose, nor does SCILLC assume any liability arising out of the application or use of any product or circuit, and specifically disclaims any and all liability, including without limitation special, consequential or incidental damages. "Typical" parameters which may be provided in SCILLC data sheets and/or specifications can and do vary in different applications and actual performance may vary over time. All operating parameters, including "Typicals" must be validated for each customer application by customer's technical experts. SCILLC does not convey any license under its patent rights nor the rights of others. SCILLC products are not designed, intended, or authorized for use as components in systems intended for surgical implant into the body, or other applications intended to support or sustain life, or for any other application in which the failure of the SCILLC product could create a situation where personal injury or death may occur. Should Buyer purchase or use SCILLC products for any such unintended or unauthorized application, Buyer shall indemnify and hold SCILLC and its officers, employees, subsidiaries, affiliates, and distributors harmless against all claims, costs, damages, and expenses, and reasonable attorney fees arising out of, directly or indirectly, any claim of personal injury or death associated with such unintended or unauthorized use, even if such claim alleges that SCILLC was negligent regarding the design or manufacture of the part. SCILLC is an Equal Opportunity/Affirmative Action Employer. This literature is subject to all applicable copyright laws and is not for resale in any manner.

**PUBLICATION ORDERING INFORMATION**

**LITERATURE FULFILLMENT:**  
Literature Distribution Center for ON Semiconductor  
P.O. Box 5163, Denver, Colorado 80217 USA  
**Phone:** 303-675-2175 or 800-344-3860 Toll Free USA/Canada  
**Fax:** 303-675-2176 or 800-344-3867 Toll Free USA/Canada  
**Email:** orderlit@onsemi.com

**N. American Technical Support:** 800-282-9855 Toll Free USA/Canada  
**Europe, Middle East and Africa Technical Support:**  
Phone: 421 33 790 2910  
**Japan Customer Focus Center**  
Phone: 81-3-5773-3850

**ON Semiconductor Website:** [www.onsemi.com](http://www.onsemi.com)  
**Order Literature:** <http://www.onsemi.com/orderlit>

For additional information, please contact your local Sales Representative

## Looking for pricing, stock, or lifecycle information?

Click below to explore more details on WIN SOURCE:

- ⊖ [View CAT8900B125TBGT3 on WIN SOURCE](#)
- ⊖ [ON Semiconductor Information](#)

## Optimize Your Supply Chain with WIN SOURCE Solutions

- ✓ Global Sourcing Solution
- ✓ Obsolete Management
- ✓ Cost Control Management
- ✓ Shortage Management
- ✓ Alternative Solution
- ✓ Excess Inventory Management